

LCD MODULE

MODULE NO. :

KSECB1601XXX-R02-SERIES**Customer:**

Approved by:

| Approved by | Checked by | Prepared by |
|-------------|------------|-------------|
| | | |

RECORDS OF REVISION

| Part Number | Revision | Revision Content | Revised on |
|--------------------|-----------------|-------------------------|-------------------|
| KSECB1601XXX-R02 | 1.0 | First issue | Nov. 4th, 2022 |
| | | | |
| | | | |
| | | | |

CONTENTS

1. FUNCTIONS & FEATURES 4

2. MECHANICAL SPECIFICATIONS 5

3. EXTERNAL DIMENSIONS 6

4. BLOC`K DIAGRAM 7

5. PIN ASSIGNMENT7

6. BACKLIGHT ELECTRICAL/OPTICAL SPECIFICATIONS 8

7. MAXIMUM ABSOLUTE POWER RATINGS 8

8. ELECTRICAL CHARACTERISTICS 9

9. DISPLAY DATA RAM (DDRAM) 10

10. INSTRUCTION TABLE 11

11. INITIALIZING BY INSTRUCTION 12

12. CHARACTER GENERATOR ROM 13

14. RELIABILITY TEST 16

15. INSPECTION SPECIFICATION 17

16. LCD MODULES HANDLING PRECAUTIONS 20

17. OTHERS 20

1. MODULE CLASSIFICATION INFORMATION**KSE C B 1601 X X X - R 02**

① ② ③ ④ ⑤ ⑥ ⑦ ⑧ ⑨

① KSE: KEEN SIDE electronics

② C: Character Type, G: Graphic Type

③ B: COB, G: COG

④ Display Font: 16 * 1

⑤ LCD Mode:

B→ STN-Blue Negative

F→ FSTN Positive

G→ STN Gray Positive

Y→ STN Yellow Green Positive

⑥ Backlight Type:

N→ Without backlight

A→ Amber LED backlight

B→ Blue LED backlight

G→ Green LED backlight

R→ Red LED backlight

W→ Withe LED backlight

Y→ Yellow-Green LED backlight

⑦ LCD Polarize Type/Temperature range/View direction :

D→ Transflective, W.T, 12:00

E→ Transmissive, W.T, 6:00

P→ Reflective, W. T, 6:00

Q→ Transmissive, W.T, 12:00

Z→ Transflective, W.T, 6:00

⑧ Character Bank :

A→ English / Japan

B→ English / European

R→ English / Cyrillic / Portuguese / Russian

T→ English / Russian

G→ Hebrew

⑨ Model serials no. :

2. FUNCTIONS & FEATURES

- KSECB1601XXX-R02 Series LCD type:
- DisplayContents :16*1 Characters(5*8dots)
- Driving Scheme : 1/16 Duty; 1/5Bias
- Driver IC : AIP31066L-002
- Operating Voltage : 5.0V
- Interface :4/8-bit Parallel
- Operating Temperature :-20°C - +70°C
- Storage Temperature :-30°C - +80°C
- RoHS Compliant

3. MECHANICAL SPECIFICATIONS

- Outline Dimensions : 122.00(W) x 33.00(L) x 13.00max(H)(mm)
- Viewing Area : 99.00 (W) x 13.00(L)(mm)
- Active Area : 94.84 (W) x 9.66 (L)(mm)
- Character size : 4.84 (W) x 8.06(L)(mm)
- Character Pitch : 6.00 (W) x 9.66 (L)(mm)
- Dot Pitch : 0.98 (W) x 1.16 (L)(mm)
- Dot Size : 0.92 (W) x 1.10 (L)(mm)
- Weight : TBD

4. EXTERNAL DIMENSIONS

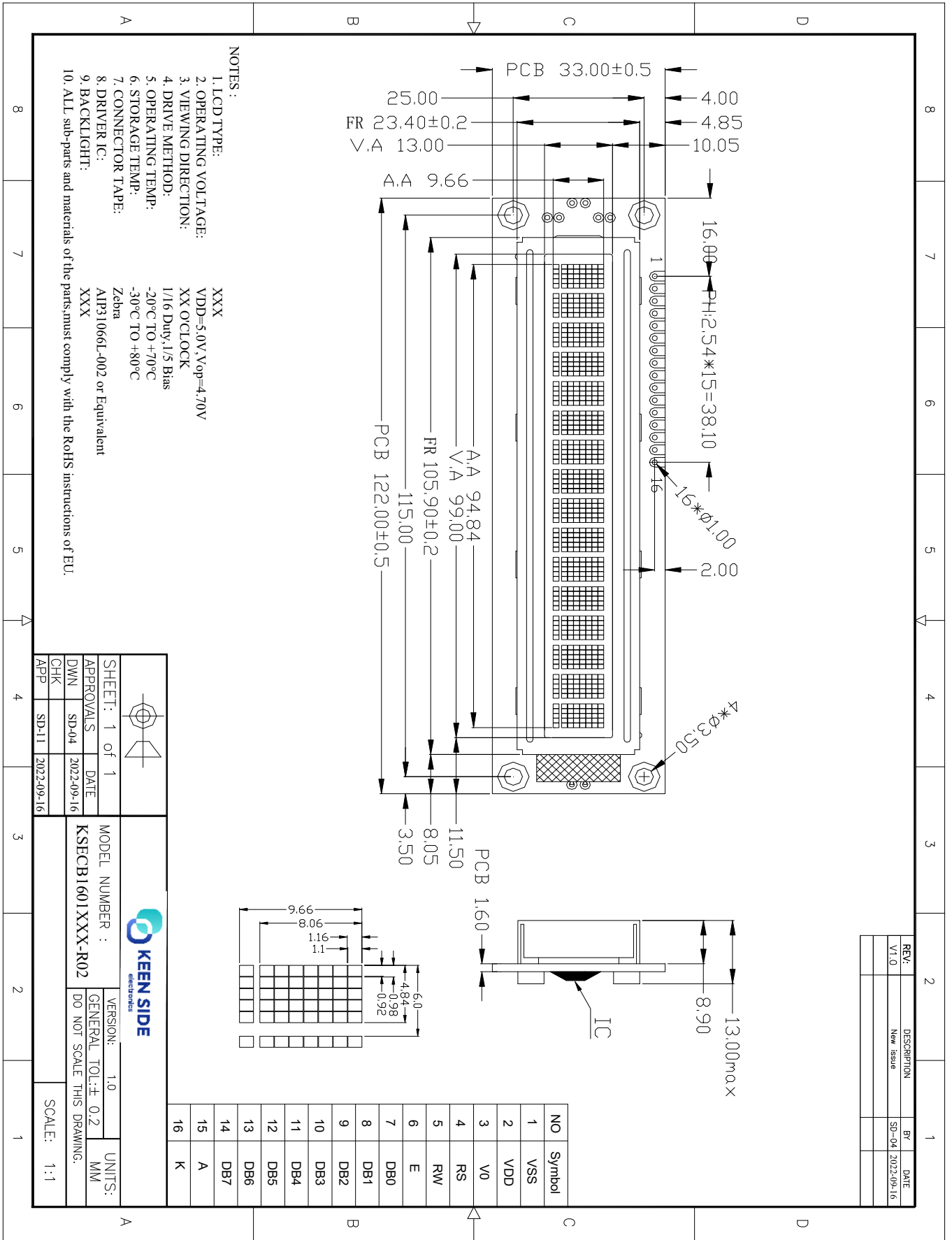

4. BLOC`K DIAGRAM

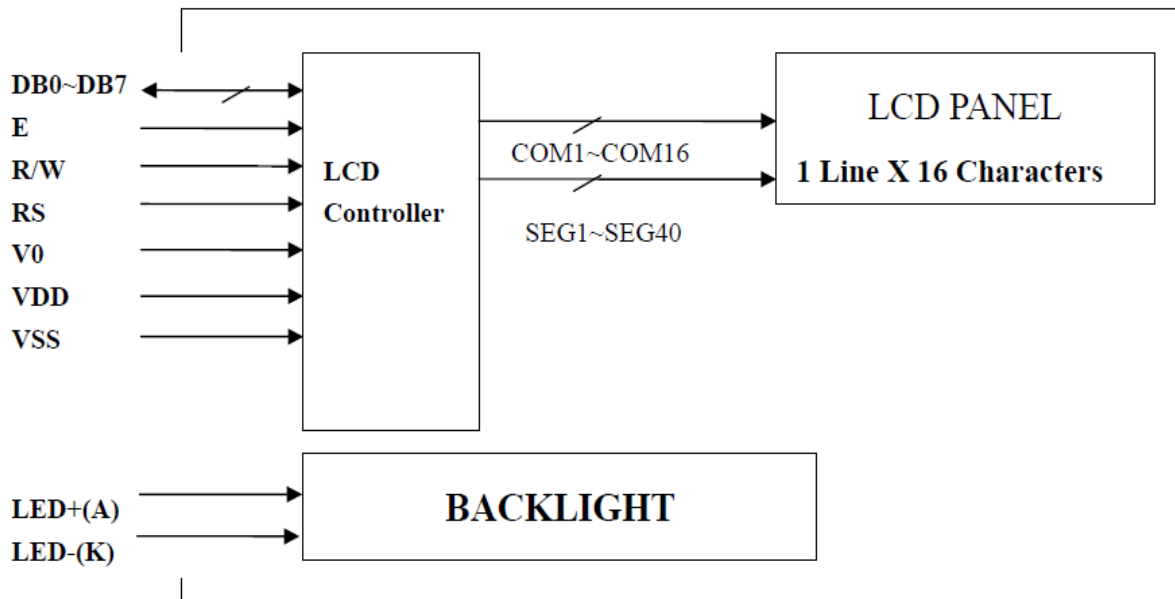

6. PIN ASSIGNMENT

| Pin No. | Symbol | Function |
|---------|--------|--|
| 1 | VSS | Ground terminal of module. |
| 2 | VDD | Power terminal of module |
| 3 | V0 | Power Supply for liquid crystal drive. |
| 4 | RS | Register select RS = 0...Instruction register RS = 1...Data register |
| 5 | R/W | Read /Write R/W = 1...Read R/W = 0...Write |
| 6 | E | Read/Write Enable Signal |
| 7 | DB0 | Bi-directional data bus, data transfer is performed once, thru DB0 to DB7, in the case of interface data. Length is 8-bits; and twice, thru DB4 to DB7 in the case of interface data length is 4-bits. Upper four bits first then lower four bits. |
| 8 | DB1 | |
| 9 | DB2 | |
| 10 | DB3 | |
| 11 | DB4 | |
| 12 | DB5 | |
| 13 | DB6 | |
| 14 | DB7 | |
| 15 | A | Anode of Backlight |
| 16 | K | Cathode of Backlight |

7. BACKLIGHT ELECTRICAL/OPTICAL SPECIFICATIONS

Electrical/Optical Specifications (Yellow-Green)

| ITEM | SYMBOL | MIN. | TYP. | MAX. | UNIT | CONDITIONS |
|--------------------------|----------------|------|------|------|-------------------|------------------------|
| Forward Voltage | V _f | 4.0 | 5.0 | 5.2 | V | I _f = 15 mA |
| Reverse Current | I _r | | | 100 | μA | V _r =5.0 V |
| Dominant wave length | λ _D | 569 | 572 | 575 | nm | I _f = 15 mA |
| Spectral Line Half width | Δ λ | | 25 | | nm | I _f = 15 mA |
| Luminous | L _v | 70 | | | cd/m ² | I _f = 15 mA |

Electrical/Optical Specifications (White)

| ITEM | SYMBOL | MIN. | TYP. | MAX. | UNIT | CONDITIONS |
|--------------------------|----------------|------|------|------|-------------------|------------------------|
| Forward Voltage | V _f | 4.8 | 5.0 | 5.2 | V | I _f = 15 mA |
| Reverse Current | I _r | | | 100 | μA | V _r =5.0 V |
| Dominant wave length | X | 0.26 | -- | 0.30 | | I _f = 15 mA |
| | Y | 0.26 | -- | 0.30 | - | |
| Spectral Line Half width | Δ λ | | -- | | nm | I _f = 15 mA |
| Luminous | L _v | 70 | | | cd/m ² | I _f = 15 mA |

8. MAXIMUM ABSOLUTE POWER RATINGS

| ITEM | SYMBOL | STANDRADVALUE | UNIT |
|-------------------------|------------------|------------------|------|
| Power supply voltage(1) | VDD | -0.3~+7.0 | V |
| Power supply voltage(2) | VLCD | VDD-10.0~VDD+0.3 | V |
| Input voltage | VIN | -0.3~VDD+0.3 | V |
| Operating temperature | T _{opr} | -20~+70 | °C |
| Storage temperature | T _{stg} | -30~+80 | °C |

*Voltage greater than above may damage to the Circuit.

$$VDD > V1 > V2 > V3 > V4 > V5$$

9. ELECTRICAL CHARACTERISTICS

9-1 DC Characteristics

| Item | Symbol | Standard Value | | | Test Condition | Unit |
|---------------------|------------------|----------------|-----|-----|---|------|
| | | MIN | TYP | MAX | | |
| Operating Voltage | V _{DD} | 4.8 | 5.0 | 5.2 | ----- | V |
| Supply Current | I _{DD1} | ---- | TBD | 1.0 | Ceramic oscillation fosc=250kHz | mA |
| | I _{DD2} | ---- | TBD | 0.6 | Resistor oscillation external clock operation fosc=270kHz | |
| LCD Driving Voltage | V _{LCD} | 4.5 | 4.7 | 4.9 | V _{DD} -V ₀ | V |

9-2 AC Characteristics

9.2.1 Write mode

| Characteristic | Symbol | Min | Type | Max | Unit | Test PIN |
|-----------------------|---------------------------------|------|------|-----|------|----------|
| Enable Cycle Time | t _c | 1200 | --- | --- | ns | E |
| Enable Pulse Time | T _{PW} | 460 | --- | --- | ns | E |
| Enable Rise/Fall Time | T _R , T _F | --- | --- | 25 | ns | E |
| Address Set-up Time | T _{AS} | 0 | --- | --- | ns | R/W,RS,E |
| Address Hold Time | T _{AH} | 10 | --- | --- | ns | R/W,RS,E |
| Data Set-up Time | T _{DSW} | 80 | --- | --- | ns | DB0~DB7 |
| Data Hold Time | T _H | 10 | --- | --- | ns | DB0~DB7 |

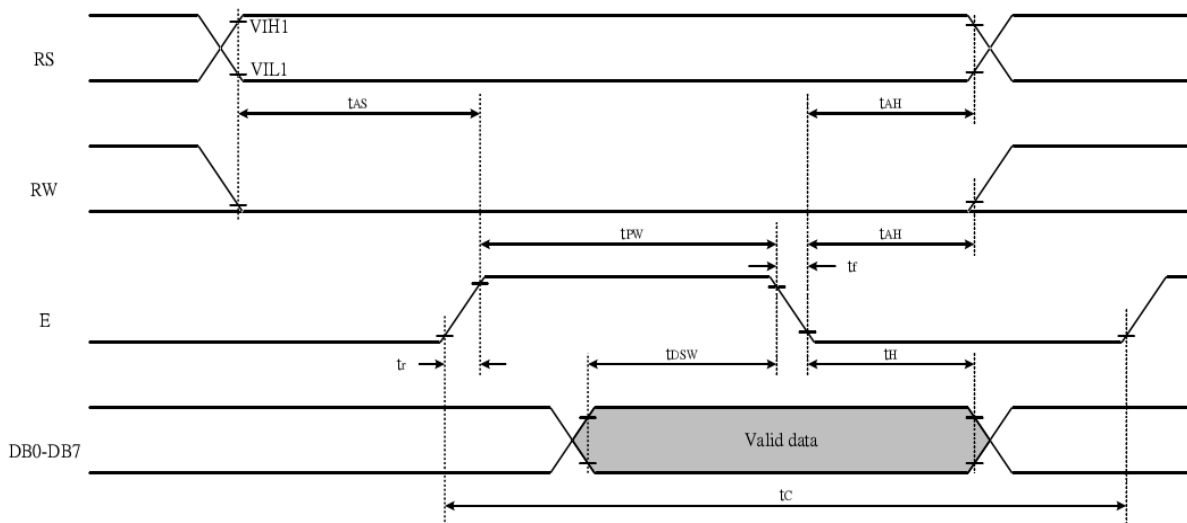

9.2.2 Read mode

| Characteristic | Symbol | Min | Type | Max | Unit | Test PIN |
|-----------------------|------------|------|------|-----|------|----------|
| Enable Cycle Time | t_C | 1200 | --- | --- | ns | E |
| Enable Pulse Time | T_{PW} | 480 | --- | --- | ns | E |
| Enable Rise/Fall Time | T_R, T_F | --- | --- | 25 | ns | E |
| Address Set-up Time | T_{AS} | 0 | --- | --- | ns | R/W,RS,E |
| Address Hold Time | T_{AH} | 10 | --- | --- | ns | R/W,RS,E |
| Data Set-up Time | T_{DDR} | --- | --- | 320 | ns | DB0~DB7 |
| Data Hold Time | T_H | 10 | --- | --- | ns | DB0~DB7 |

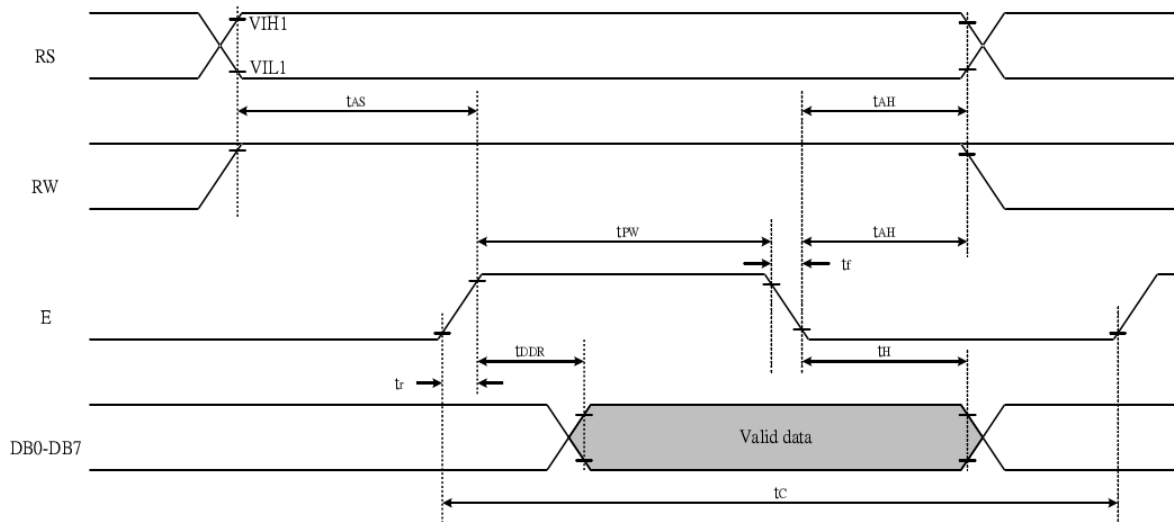

10. DISPLAY DATA RAM (DDRAM)

| | | | | | | | | | | | | | | | | | |
|-----------|----|----|----|----|----|----|----|----|----|----|----|----|----|----|----|----|--------------------|
| | 1 | 2 | 3 | 4 | 5 | 6 | 7 | 8 | 9 | 10 | 11 | 12 | 13 | 14 | 15 | 16 | ← Display Position |
| FIRT LINE | 00 | 01 | 02 | 03 | 04 | 05 | 06 | 07 | 40 | 41 | 42 | 43 | 44 | 45 | 46 | 47 | ← DDRAM Address |

When the display shift operation is performed, the DDRAM Address moved as follow:

After the left shift instruction

| | | | | | | | | | | | | | | | | | |
|--|----|----|----|----|----|----|----|----|----|----|----|----|----|----|----|----|--------------------|
| | 1 | 2 | 3 | 4 | 5 | 6 | 7 | 8 | 9 | 10 | 11 | 12 | 13 | 14 | 15 | 16 | ← Display Position |
| | 01 | 02 | 03 | 04 | 05 | 06 | 07 | 08 | 41 | 42 | 43 | 44 | 45 | 46 | 47 | 48 | ← DDRAM Address |

After the right shift instruction

| | | | | | | | | | | | | | | | | | |
|--|----|----|----|----|----|----|----|----|----|----|----|----|----|----|----|----|--------------------|
| | 1 | 2 | 3 | 4 | 5 | 6 | 7 | 8 | 9 | 10 | 11 | 12 | 13 | 14 | 15 | 16 | ← Display Position |
| | 27 | 00 | 01 | 02 | 03 | 04 | 05 | 06 | 67 | 40 | 41 | 42 | 43 | 44 | 45 | 46 | ← DDRAM Address |

11. INSTRUCTION TABLE

| Command | RS | R/W | DB7 | DB6 | DB5 | DB4 | DB3 | DB2 | DB1 | DB0 | Execution time (fosc=270KHz) | Remark |
|-------------------------|----|-----|-----|-----|-----|-----|-----|-----|-----|-----|------------------------------|--|
| Clear Display | 0 | 0 | 0 | 0 | 0 | 0 | 0 | 0 | 0 | 1 | 1.52ms | Write"20H" to DDRAM. And set DDRAM address to "00H" from AC |
| Return home | 0 | 0 | 0 | 0 | 0 | 0 | 0 | 0 | 1 | x | 1.52ms | Set DDRAM address to "00H" from AC and return cursor to its original position if shifted. The contents of DDRAM are not changed. |
| Entry mode Set | 0 | 0 | 0 | 0 | 0 | 0 | 0 | 1 | I/D | S | 37us | Sets cursor move direction and specifies display shift. These operations are performed during data write and read. |
| Display on/off control | 0 | 0 | 0 | 0 | 0 | 0 | 1 | D | C | B | 37us | D=1: entire display on C=1: cursor on B=1: cursor position on |
| Cursor or Display Shift | 0 | 0 | 0 | 0 | 0 | 1 | S/C | R/L | x | x | 37us | Set cursor moving and display shift control bit, and the direction, without changing DDRAM data. |
| function Set | 0 | 0 | 0 | 0 | 1 | DL | N | F | x | x | 37us | DL: interface data is 8/4 bits N: number of line is 2/1 F: font size is 5x11/5x8 |
| Set CGRAM address | 0 | 0 | 0 | 1 | AC5 | AC4 | AC3 | AC2 | AC1 | AC0 | 37us | Set CGRAM address in address counter |
| Set DDRAM address | 0 | 0 | 1 | AC6 | AC5 | AC4 | AC3 | AC2 | AC1 | AC0 | 37us | Set DDRAM address in address counter |
| Read busy flag& address | 0 | 1 | BF | AC6 | AC5 | AC4 | AC3 | AC2 | AC1 | AC0 | 0us | Whether during internal operation or not can be known by reading BF. The contents of address counter can also be read. |
| Write data to RAM | 1 | 0 | D7 | D6 | D5 | D4 | D3 | D2 | D1 | D0 | 37us | Write data into internal RAM (DDRAM/CGRAM) |
| Read data from RAM | 1 | 1 | D7 | D6 | D5 | D4 | D3 | D2 | D1 | D0 | 37us | Read data from internal RAM (DDRAM / CGRAM) |

Note:

Be sure the AIP31066 is not in the busy state (BF=00) before sending an instruction from the MPU to the AIP31066. If an instruction is sent without checking the busy flag, the time between the first instruction and next instruction will take much longer than the instruction time itself. Refer to instruction table for the list of each instruction execution time.

12. INITIALIZING BY INSTRUCTION

8-bit interface mode (fosc=270kHz)

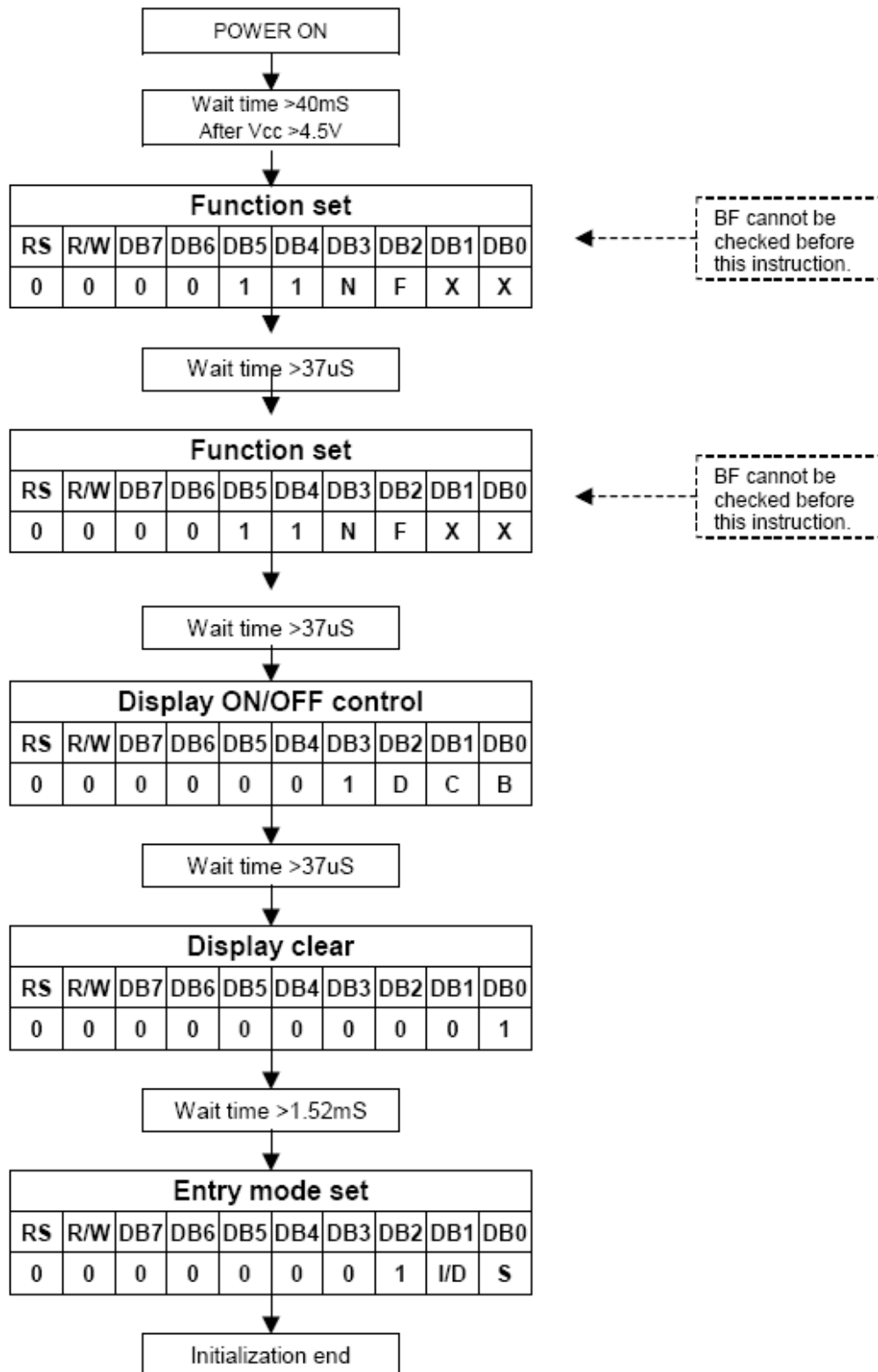

13. CHARACTER GENERATOR ROM

002

| b7-b4 b3-b0 | 0000 | 0001 | 0010 | 0011 | 0100 | 0101 | 0110 | 0111 | 1000 | 1001 | 1010 | 1011 | 1100 | 1101 | 1110 | 1111 |
|----------------|------------------|------|------|------|------|------|------|------|------|------|------|------|------|------|------|------|
| 0000 | CG RAM (1) | | | 0 | 1 | 2 | 3 | 4 | | | 5 | 6 | 7 | 8 | 9 | 0 |
| 0001 | (2) | | ! | 1 | A | Q | a | q | | | 7 | R | W | . | U | 8 |
| 0010 | (3) | | " | 2 | B | R | b | r | | | E | S | Y | u | W | 9 |
| 0011 | (4) | | # | 3 | C | S | c | s | | | X | B | W | 0 | A | 4 |
| 0100 | (5) | | \$ | 4 | D | T | d | t | | | 3 | F | Y | Z | o | H |
| 0101 | (6) | | % | 5 | E | U | e | u | | | M | E | a | X | U | 7 |
| 0110 | (7) | | & | 6 | F | V | f | v | | | N | R | W | Z | W | 3 |
| 0111 | (8) | | ' | 7 | G | W | g | w | | | J | B | R | I | ' | F |
| 1000 | (1) | | < | 8 | H | X | h | x | | | 7 | N | o | U | ' | # |
| 1001 | (2) | | > | 9 | I | Y | i | y | | | V | X | o | ↑ | ' | 3 |
| 1010 | (3) | | * | : | J | Z | j | z | | | o | K | o | ↓ | e | 4 |
| 1011 | (4) | | + | ; | K | [| k |] | | | 4 | a | " | N | o | # |
| 1100 | (5) | | , | < | L | o | l | o | | | W | N | N | N | o | 8 |
| 1101 | (6) | | - | = | M |] | m |] | | | 6 | H | o | N | # | o |
| 1110 | (7) | | . | > | N | ^ | n | ^ | | | B | 7 | Y | Z | o | 9 |
| 1111 | (8) | | / | ? | O | _ | o | _ | | | 8 | T | E | . | o | ■ |

14. Optical Characteristics

14.1 Definition of Viewing Angle

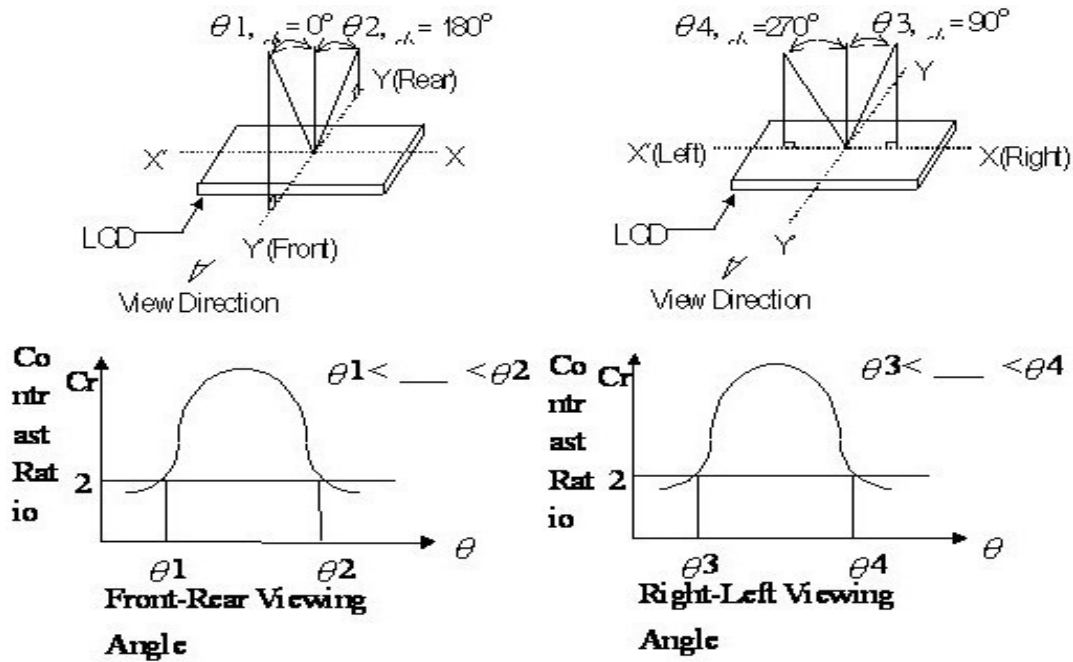

14.2 Definition of Contrast

$$\text{C.R} = \frac{\text{Brightness of nonselected segment (E2)}}{\text{Brightness of selected segment}}$$

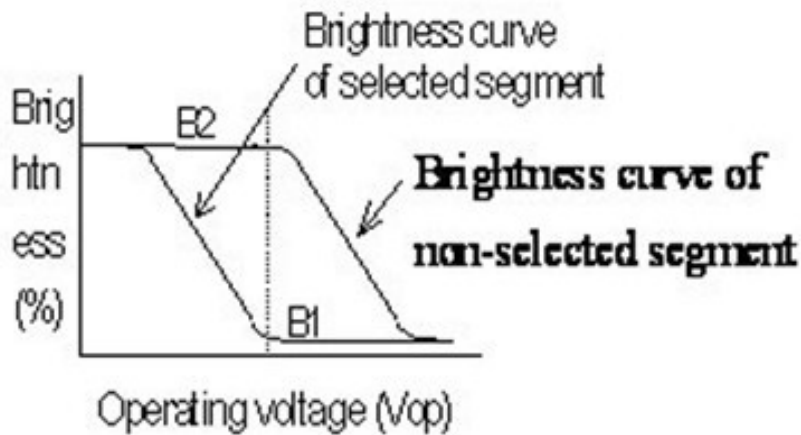

14.3 Definition of Response

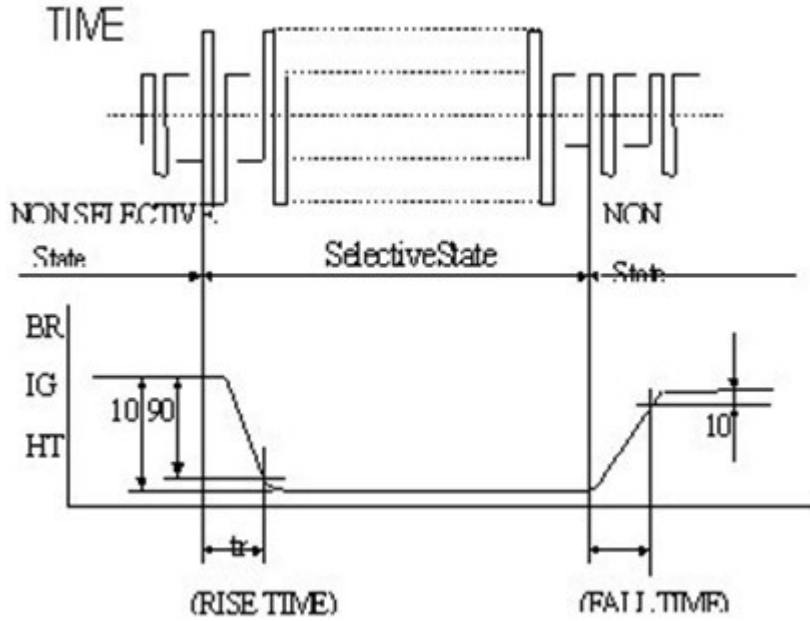

14.4 Measuring Instruments For Elector-optical Characteristics

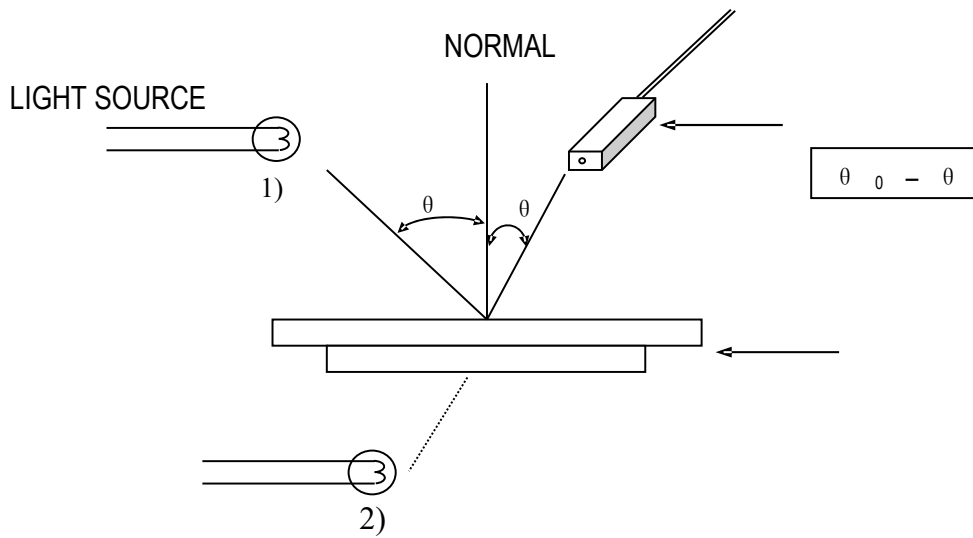

*** Note:**

- 1) Light source position for measuring the reflective type of LCD panel;
- 2) Light source position for measuring the transfective / transmissive types of LCD panel.

15. RELIABILITY TEST

Operating life time: Longer than 75,000 hours
 (at room temperature without direct irradiation of sunlight)

Reliability characteristics shall meet following requirements.

| No. | Test Item | Content of Test | Test Condition |
|-----|------------------------------------|---|--------------------------------|
| 1 | High Temperature Storage | Endurance test applying the high temperature for a long time storage | +80°C 96H |
| 2 | Low Temperature Storage | Endurance test applying the low temperature for a long time storage | -30°C 96H |
| 3 | High Temperature Operation | Endurance test applying the electric stress (voltage & current) and the thermal stress to the element for a long time | +70°C 96H |
| 4 | Low Temperature Operation | Endurance test applying the electric stress under low temperature for a long time | -20°C 96H |
| 5 | High Temperature/ Humidity Storage | Endurance test applying the high temperature and humidity storage for a long time | 40°C 90%RH 96H |
| 6 | Temperature Cycle | Endurance test applying the low and high temperature cycle $ \begin{array}{ccccccc} -20^{\circ}\text{C} & \longleftrightarrow & 25^{\circ}\text{C} & \longleftrightarrow & 70^{\circ}\text{C} & \longleftrightarrow & 25^{\circ}\text{C} \\ 30\text{min} & & 5\text{min} & & 30\text{min} & & 5\text{min} \\ \longleftarrow & & & & & & \longrightarrow \\ & & & & & & \text{1 cycle} \end{array} $ | -20°C/70°C 5 cycles |
| 7 | Vibration Test (Package State) | Endurance test applying the vibration during transportation | 10Hz - 55Hz, 50m/s, 15min |
| 8 | Shock Test (Package State) | Endurance test applying the shock during transportation | Half-sinewave, 100m/s, 11ms |
| 9 | Atmospheric Pressure Test | Endurance test applying the atmospheric pressure during transportation by air | 40 kPa 16 H |

16. Inspection specification

16.1 Visual Inspection

- 1) Inspect under 2x20W or 40W fluorescent lamp (approximately 3000 lux) leaving 25 to 30 cm between the module and the lamp and 30 cm between the module and the eye (measuring position).
- 2) Appearance is inspected at the best contrast voltage (best contrast is adjusted considering clearness and crosstalk on screen).
- 3) Inspect the module at 45° right and left, top and bottom.
- 4) Use the optimum viewing angle during the contrast inspection.

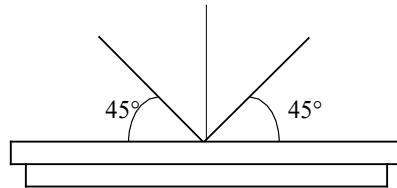

16.2 Standard of Appearance Inspection

| No. | Item | Criteria | | | | | | | | | | | | | | | | | | | | | | | | | | | | | | | | | | | |
|---------------------|----------------------------------|--|---------------------|------------|--|------|--------|--------|--------------|------------|------------|--------------------|---|---------------------|---|---------------|---|---------------------|--|--|--|--------|-------|--------|--------|---|---------------|------------|------------|--------------|----------------------|---|--------------|----------------------|---|------------|---------------|
| 1 | Black spot White spot Dust | <p>Round type: as per following drawing</p> <p>$= (X+Y)/2$</p> <table border="1"> <thead> <tr> <th colspan="3">Acceptable quantity</th> </tr> <tr> <th>Size</th> <th>Zone A</th> <th>Zone B</th> </tr> </thead> <tbody> <tr> <td>$\Phi < 0.1$</td> <td>Any number</td> <td rowspan="4">Any number</td> </tr> <tr> <td>$0.1 < \Phi < 0.2$</td> <td>2</td> </tr> <tr> <td>$0.2 < \Phi < 0.25$</td> <td>1</td> </tr> <tr> <td>$0.25 < \Phi$</td> <td>0</td> </tr> </tbody> </table> <p>Line type: as per following drawing</p> <table border="1"> <thead> <tr> <th colspan="4">Acceptable quantity</th> </tr> <tr> <th>Length</th> <th>Width</th> <th>Zone A</th> <th>Zone B</th> </tr> </thead> <tbody> <tr> <td>—</td> <td>$W \leq 0.02$</td> <td>Any number</td> <td rowspan="4">Any number</td> </tr> <tr> <td>$L \leq 3.0$</td> <td>$0.02 < W \leq 0.03$</td> <td rowspan="2">2</td> </tr> <tr> <td>$L \leq 2.5$</td> <td>$0.03 < W \leq 0.05$</td> </tr> <tr> <td>—</td> <td>$0.05 < W$</td> <td>As round type</td> </tr> </tbody> </table> <p>Total acceptable quantity: 3</p> | Acceptable quantity | | | Size | Zone A | Zone B | $\Phi < 0.1$ | Any number | Any number | $0.1 < \Phi < 0.2$ | 2 | $0.2 < \Phi < 0.25$ | 1 | $0.25 < \Phi$ | 0 | Acceptable quantity | | | | Length | Width | Zone A | Zone B | — | $W \leq 0.02$ | Any number | Any number | $L \leq 3.0$ | $0.02 < W \leq 0.03$ | 2 | $L \leq 2.5$ | $0.03 < W \leq 0.05$ | — | $0.05 < W$ | As round type |
| | | Acceptable quantity | | | | | | | | | | | | | | | | | | | | | | | | | | | | | | | | | | | |
| | | Size | Zone A | Zone B | | | | | | | | | | | | | | | | | | | | | | | | | | | | | | | | | |
| | | $\Phi < 0.1$ | Any number | Any number | | | | | | | | | | | | | | | | | | | | | | | | | | | | | | | | | |
| $0.1 < \Phi < 0.2$ | 2 | | | | | | | | | | | | | | | | | | | | | | | | | | | | | | | | | | | | |
| $0.2 < \Phi < 0.25$ | 1 | | | | | | | | | | | | | | | | | | | | | | | | | | | | | | | | | | | | |
| $0.25 < \Phi$ | 0 | | | | | | | | | | | | | | | | | | | | | | | | | | | | | | | | | | | | |
| Acceptable quantity | | | | | | | | | | | | | | | | | | | | | | | | | | | | | | | | | | | | | |
| Length | Width | Zone A | Zone B | | | | | | | | | | | | | | | | | | | | | | | | | | | | | | | | | | |
| — | $W \leq 0.02$ | Any number | Any number | | | | | | | | | | | | | | | | | | | | | | | | | | | | | | | | | | |
| $L \leq 3.0$ | $0.02 < W \leq 0.03$ | 2 | | | | | | | | | | | | | | | | | | | | | | | | | | | | | | | | | | | |
| $L \leq 2.5$ | $0.03 < W \leq 0.05$ | | | | | | | | | | | | | | | | | | | | | | | | | | | | | | | | | | | | |
| — | $0.05 < W$ | As round type | | | | | | | | | | | | | | | | | | | | | | | | | | | | | | | | | | | |
| 2 | Polariser scratch | Scratch on protective film is permitted Scratch on polariser: same as No. 1 | | | | | | | | | | | | | | | | | | | | | | | | | | | | | | | | | | | |
| 3 | Polariser bubble | $\Phi = (X+Y)/2$ | | | | | | | | | | | | | | | | | | | | | | | | | | | | | | | | | | | |

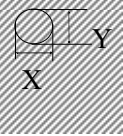
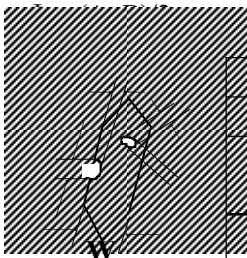
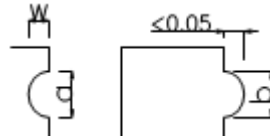
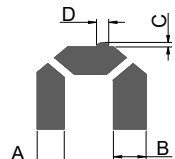
| | |  <table border="1" data-bbox="766 235 1428 548"> <thead> <tr> <th colspan="3">Acceptable quantity</th> </tr> <tr> <th>Size</th> <th>Zone A</th> <th>Zone B</th> </tr> </thead> <tbody> <tr> <td>$\Phi < 0.2$</td> <td>Any number</td> <td rowspan="4">Any number</td> </tr> <tr> <td>$0.2 < \Phi < 0.5$</td> <td>2</td> </tr> <tr> <td>$0.5 < \Phi < 1.0$</td> <td>1</td> </tr> <tr> <td>$1.0 < \Phi$</td> <td>0</td> </tr> </tbody> </table> <p>Total acceptable quantity: 3</p> | Acceptable quantity | | | Size | Zone A | Zone B | $\Phi < 0.2$ | Any number | Any number | $0.2 < \Phi < 0.5$ | 2 | $0.5 < \Phi < 1.0$ | 1 | $1.0 < \Phi$ | 0 | | | | | | | | | |
|---------------------|---------------------------------------|---|---------------------|--|-------|----------|--------------|--------------------------------------|--------------|---------------------------------------|---------------------|--------------------|------|--------------------|--------------|--------------|--------------------|------------|--------------------|---|------------|--|------------|----------------|---------|-------------|
| Acceptable quantity | | | | | | | | | | | | | | | | | | | | | | | | | | |
| Size | Zone A | Zone B | | | | | | | | | | | | | | | | | | | | | | | | |
| $\Phi < 0.2$ | Any number | Any number | | | | | | | | | | | | | | | | | | | | | | | | |
| $0.2 < \Phi < 0.5$ | 2 | | | | | | | | | | | | | | | | | | | | | | | | | |
| $0.5 < \Phi < 1.0$ | 1 | | | | | | | | | | | | | | | | | | | | | | | | | |
| $1.0 < \Phi$ | 0 | | | | | | | | | | | | | | | | | | | | | | | | | |
| 4 | Segment deformation | <p>4.1 Pin hole on segmented display W: segment width</p>  <table border="1" data-bbox="837 784 1428 1019"> <thead> <tr> <th colspan="2">Acceptable quantity</th> </tr> <tr> <th>Width</th> <th>Quantity</th> </tr> </thead> <tbody> <tr> <td>$W \leq 0.4$</td> <td>$\Phi \leq 0.2$ and $\Phi \leq 1/2W$</td> </tr> <tr> <td>$W > 0.4$</td> <td>$\Phi \leq 0.25$ and $\Phi \leq 1/3W$</td> </tr> </tbody> </table> <p>Total acceptable quantity: 1 defect per segment Pin holes with Φ under 0.10 mm are acceptable</p> <p>4.2 Pin hole on dot matrix display</p>  <table border="1" data-bbox="981 1209 1428 1444"> <thead> <tr> <th colspan="2">Acceptable quantity</th> </tr> <tr> <th>Size</th> <th>Quantity</th> </tr> </thead> <tbody> <tr> <td>$a, b < 0.1$</td> <td>Any number</td> </tr> <tr> <td>$(a+b)/2 \leq 0.1$</td> <td>Any number</td> </tr> <tr> <td>$0.5 < \Phi < 1.0$</td> <td>3</td> </tr> </tbody> </table> <p>Total acceptable quantity: 7</p> <p>4.3 Segments / dots with different width</p>  <table border="1" data-bbox="981 1612 1332 1736"> <thead> <tr> <th colspan="2">Acceptable</th> </tr> </thead> <tbody> <tr> <td>$a \geq b$</td> <td>$a/b \leq 4/3$</td> </tr> <tr> <td>$a < b$</td> <td>$a/b > 4/3$</td> </tr> </tbody> </table> <p>4.4 Alignment layer defect $\Phi = (A+B)/2$</p> | Acceptable quantity | | Width | Quantity | $W \leq 0.4$ | $\Phi \leq 0.2$ and $\Phi \leq 1/2W$ | $W > 0.4$ | $\Phi \leq 0.25$ and $\Phi \leq 1/3W$ | Acceptable quantity | | Size | Quantity | $a, b < 0.1$ | Any number | $(a+b)/2 \leq 0.1$ | Any number | $0.5 < \Phi < 1.0$ | 3 | Acceptable | | $a \geq b$ | $a/b \leq 4/3$ | $a < b$ | $a/b > 4/3$ |
| Acceptable quantity | | | | | | | | | | | | | | | | | | | | | | | | | | |
| Width | Quantity | | | | | | | | | | | | | | | | | | | | | | | | | |
| $W \leq 0.4$ | $\Phi \leq 0.2$ and $\Phi \leq 1/2W$ | | | | | | | | | | | | | | | | | | | | | | | | | |
| $W > 0.4$ | $\Phi \leq 0.25$ and $\Phi \leq 1/3W$ | | | | | | | | | | | | | | | | | | | | | | | | | |
| Acceptable quantity | | | | | | | | | | | | | | | | | | | | | | | | | | |
| Size | Quantity | | | | | | | | | | | | | | | | | | | | | | | | | |
| $a, b < 0.1$ | Any number | | | | | | | | | | | | | | | | | | | | | | | | | |
| $(a+b)/2 \leq 0.1$ | Any number | | | | | | | | | | | | | | | | | | | | | | | | | |
| $0.5 < \Phi < 1.0$ | 3 | | | | | | | | | | | | | | | | | | | | | | | | | |
| Acceptable | | | | | | | | | | | | | | | | | | | | | | | | | | |
| $a \geq b$ | $a/b \leq 4/3$ | | | | | | | | | | | | | | | | | | | | | | | | | |
| $a < b$ | $a/b > 4/3$ | | | | | | | | | | | | | | | | | | | | | | | | | |

| | | <p>Total acceptable quantity: 7</p> <table border="1" style="float: right;"> <thead> <tr> <th colspan="2">Acceptable quantity</th> </tr> <tr> <th>Size</th> <th>Quantity</th> </tr> </thead> <tbody> <tr> <td>$\Phi \leq 0.4$</td> <td>Any number</td> </tr> <tr> <td>$0.4 < \Phi \leq 1.0$</td> <td>5</td> </tr> <tr> <td>$1.0 < \Phi \leq 1.5$</td> <td>3</td> </tr> <tr> <td>$1.5 < \Phi \leq 2.0$</td> <td>2</td> </tr> </tbody> </table> | Acceptable quantity | | Size | Quantity | $\Phi \leq 0.4$ | Any number | $0.4 < \Phi \leq 1.0$ | 5 | $1.0 < \Phi \leq 1.5$ | 3 | $1.5 < \Phi \leq 2.0$ | 2 | | | | |
|-----------------------|-------------------|---|---------------------|--|------|----------|-----------------|------------|-----------------------|--------------|-----------------------|---------------|-----------------------|------------|------------------|---|---------|---|
| Acceptable quantity | | | | | | | | | | | | | | | | | | |
| Size | Quantity | | | | | | | | | | | | | | | | | |
| $\Phi \leq 0.4$ | Any number | | | | | | | | | | | | | | | | | |
| $0.4 < \Phi \leq 1.0$ | 5 | | | | | | | | | | | | | | | | | |
| $1.0 < \Phi \leq 1.5$ | 3 | | | | | | | | | | | | | | | | | |
| $1.5 < \Phi \leq 2.0$ | 2 | | | | | | | | | | | | | | | | | |
| 5 | Colour uniformity | Level of sample for approval set as limit sample | | | | | | | | | | | | | | | | |
| 6 | Backlight | The backlight colour should correspond to the product specification Flashing and or unlit backlight is not allowed Dust larger than 0.25 mm is not allowed | | | | | | | | | | | | | | | | |
| 7 | COB | Exposed wire bond pad is not allowed Insufficient covering with resin is not allowed (wire bond line exposed) Dust or bubble on the resin are not allowed | | | | | | | | | | | | | | | | |
| 8 | PCB | No unmelted solder paste should be present on PCB Cold solder joints, missing solder connections, or oxidation are not allowed No residue or solder balls on PCB are allowed Short circuits on components are not allowed | | | | | | | | | | | | | | | | |
| 9 | Tray particles | <table border="1" style="margin-left: auto; margin-right: auto;"> <thead> <tr> <th colspan="3">Acceptable quantity</th> </tr> <tr> <th></th> <th>Size</th> <th>Quantity</th> </tr> </thead> <tbody> <tr> <td rowspan="2">On tray</td> <td>$\Phi < 0.2$</td> <td>Any number</td> </tr> <tr> <td>$\Phi > 0.25$</td> <td>4</td> </tr> <tr> <td rowspan="2">On display</td> <td>$\Phi \geq 0.25$</td> <td>2</td> </tr> <tr> <td>$L = 3$</td> <td>1</td> </tr> </tbody> </table> | Acceptable quantity | | | | Size | Quantity | On tray | $\Phi < 0.2$ | Any number | $\Phi > 0.25$ | 4 | On display | $\Phi \geq 0.25$ | 2 | $L = 3$ | 1 |
| Acceptable quantity | | | | | | | | | | | | | | | | | | |
| | Size | Quantity | | | | | | | | | | | | | | | | |
| On tray | $\Phi < 0.2$ | Any number | | | | | | | | | | | | | | | | |
| | $\Phi > 0.25$ | 4 | | | | | | | | | | | | | | | | |
| On display | $\Phi \geq 0.25$ | 2 | | | | | | | | | | | | | | | | |
| | $L = 3$ | 1 | | | | | | | | | | | | | | | | |

17. LCD MODULES HANDLING PRECAUTIONS

- Please remove the protection foil of polarizer before using.
- The display panel is made of glass. Do not subject it to a mechanical shock by dropping it from a high place, etc.
- If the display panel is damaged and the liquid crystal substance inside it leaks out, do not get any in your mouth. If the substance come into contact with your skin or clothes promptly wash it off using soap and water.
- Do not apply excessive force to the display surface or the adjoining areas since this may cause the color tone to vary.
- The polarizer covering the display surface of the LCD module is soft and easily scratched. Handle this polarize carefully.
- To prevent destruction of the elements by static electricity, be careful to maintain an optimum work environment.
 - Be sure to ground the body when handling the LCD module.
 - Tools required for assembly, such as soldering irons, must be properly grounded.
 - To reduce the amount of static electricity generated, do not conduct assembly and other work under dry conditions.
 - The LCD module is coated with a film to protect the display surface. Exercise care when peeling off this protective film since static electricity may be generated.
- Storage precautions
When storing the LCD modules, avoid exposure to direct sunlight or to the light of fluorescent lamps. Keep the modules in bags designed to prevent static electricity charging under low temperature / normal humidity conditions (avoid high temperature / high humidity and low temperatures below 0 °C).Whenever possible, the LCD modules should be stored in the same conditions in which they were shipped from our company.

18. OTHERS

- Liquid crystals solidify at low temperature (below the storage temperature range) leading to defective orientation of liquid crystal or the generation of air bubbles (black or white). Air bubbles may also be generated if the module is subjected to a strong shock at a low temperature.
- If the LCD modules have been operating for a long time showing the same display patterns may remain on the screen as ghost images and a slight contrast irregularity may also appear. Abnormal operating status can be resumed to be normal condition by suspending use for some time. It should be noted that this phenomena does not adversely affect performance reliability.
- To minimize the performance degradation of the LCD modules resulting from caused by static electricity, etc. exercise care to avoid holding the following sections when handling the modules:
 - Exposed area of the printed circuit board
 - Terminal electrode sections