

LCD MODULE

MODULE NO. :

KSEGG12864-215C SERIES**Customer:**

Approved by:

Approved by	Checked by	Prepared by

RECORDS OF REVISION

Part Number	Revision	Revision Content	Revised on
KSEGG12864-215C	1.0	First issue	June. 20th, 2016

CONTENTS

1. FUNCTIONS & FEATURES4

2. MECHANICAL SPECIFICATIONS.....4

3. EXTERNAL DIMENSIONS.....5

4. BLOC`K DIAGRAM.....6

5. PIN ASSIGNMENT.....6

6. BACKLIGHT ELECTRICAL/OPTICAL SPECIFICATIONS7

7. MAXIMUM ABSOLUTE POWER RATINGS7

8. ELECTRICAL CHARACTERISTICS7

9. INSTRUCTION TABLE.....9

10. OPTICAL CHARACTERISTICS10

11. MODULE ACCEPT QUALITY LEVEL (AQL)12

12. RELIABILITY TEST.....12

13. INSPECTION SPECIFICATION.....13

14. LCD MODULES HANDLING PRECAUTIONS.....16

15. OTHERS.....16

1. FUNCTIONS & FEATURES

- KSEGG12864-215C Series LCD type:

Module	LCD Type	Remark
SDGG12864FWZ-215C	FSTN Transflective Positive Mode	Backlight: White

- Display Contents :128 x 64 Dots
- Driving Scheme : 1/65Duty; 1/9Bias
- Viewing Direction :6 O' clock
- Power Supply Voltage : 3.0V.
- Driver IC : UC1601X
- Interface :4-SPI
- Backlight :white
- Operating Temperature :-20°C - + 70°C
- Storage Temperature :-30°C - + 80°C
- RoHS Compliant
- KSE — KEEN SIDE electronics

2. MECHANICAL SPECIFICATIONS

- Outline Dimensions : 43.60(W) x 33.80(L) x 2.20(H)(mm)
- Viewing Area : 39.80 (W) x 25.50(L)(mm)
- Active Area : 37.09 (W) x 23.01 (L)(mm)
- Dot Pitch : 0.03 (W) x 0.03 (L)(mm)
- Dot Size : 0.26 (W) x 0.33 (L)(mm)
- Weight : TBD

3. EXTERNAL DIMENSIONS

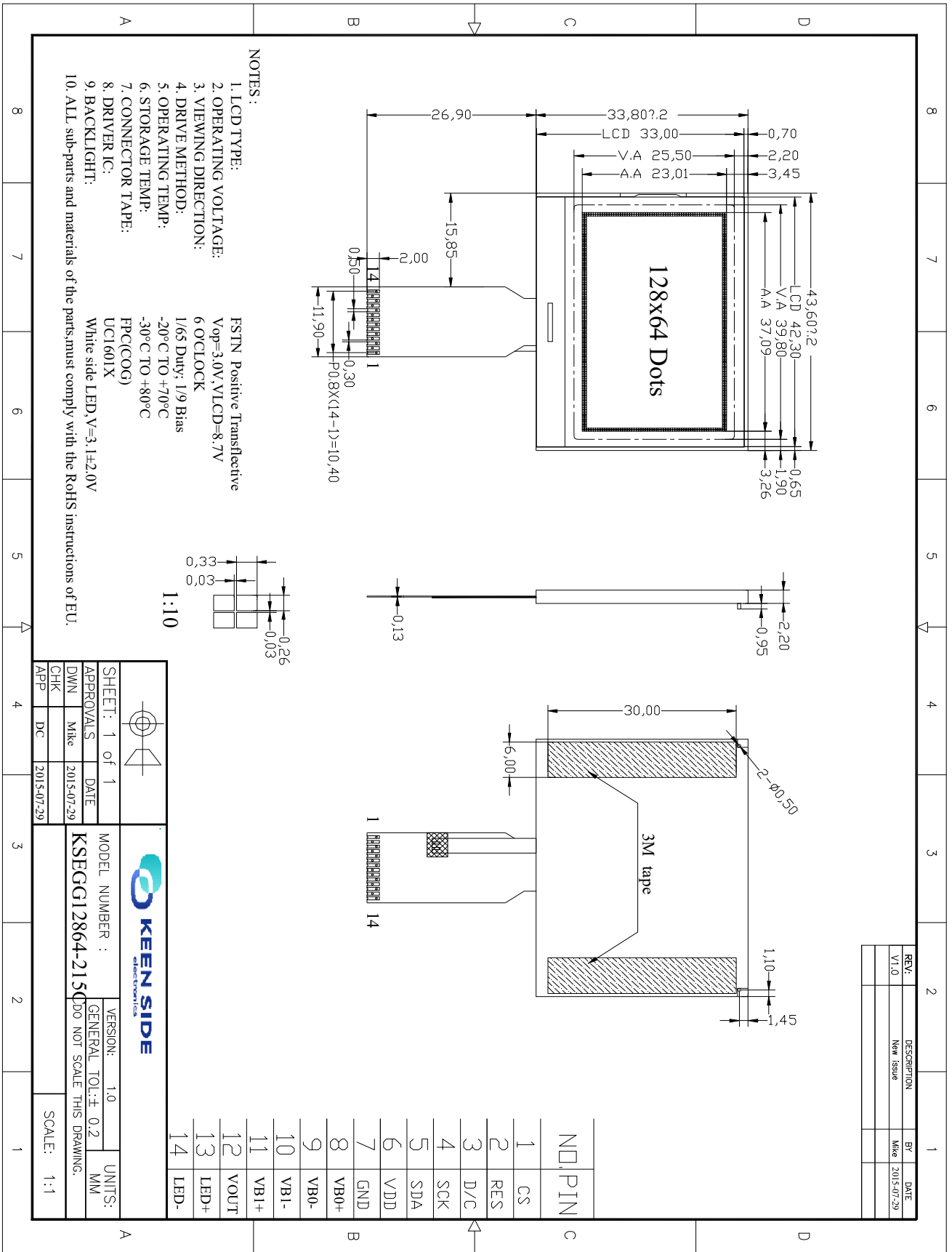

4. BLOC`K DIAGRAM

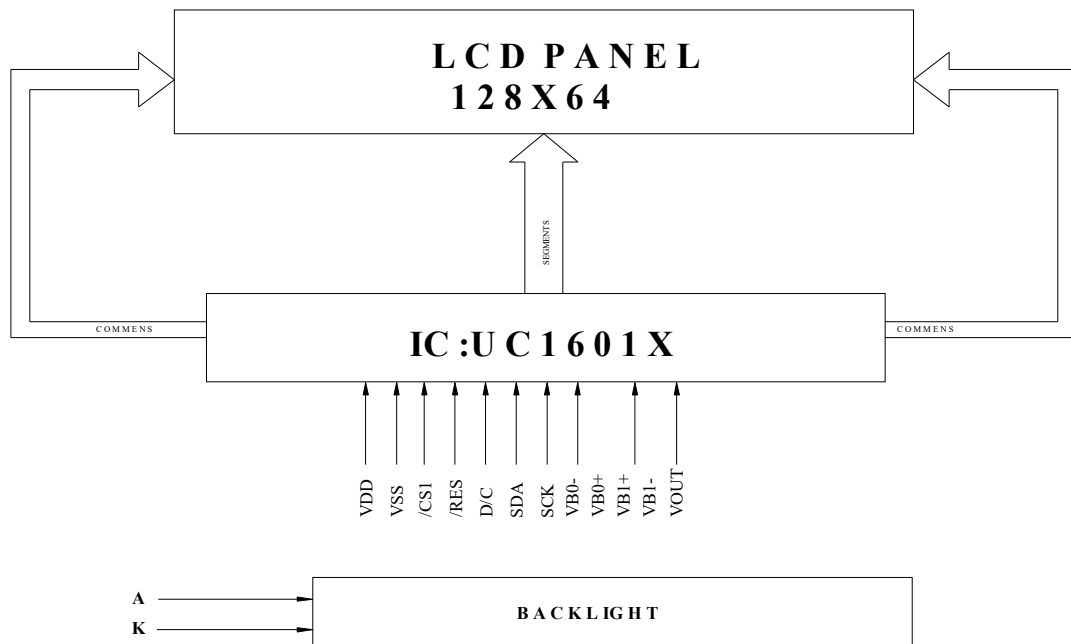

5. PIN ASSIGNMENT

Pin No.	Symbol	Function
1	/CS	This is the chip select signal.
2	/RES	When /RES is set to “L”, the register settings are initialized (cleared). The reset operation is performed by the /RES signal level.
3	D/C	This is connecting to the least significant bit of the normal MPU address bus, and it determines whether the data bits are data or command. D/C = “H”: Indicates display data. D/C = “L”: Indicates control data.
4	SCK	The serial clock input
5	SDA	The serial data input
6	VDD	Power terminal of module
7	VSS	Ground terminal of module.
8-11	VB0+ VB0- VB1- VB1+	LCD Bias Voltages. These are the voltage sources to provide SEG driving currents. These voltages are generated internally. Connect capacitors of CBX value between VBX+ and VBX-.
12	VOUT	Main LCD Power Supply. When VLCD is used, connect these pins together.
13	LEDA	Anode of Backlight
14	LEDK	Cathode of Backlight

6. BACKLIGHT ELECTRICAL/OPTICAL SPECIFICATIONS**Electrical/Optical Specifications**

ITEM	SYMBOL	MIN.	TYP.	MAX.	UNIT	CONDITIONS
Forward Voltage	Vf	2.9	3.1	3.3	V	If= 15 x2 mA
Reverse Current	Ir			120	mA	Vr=5.0 V
Power Dissipation	Pd			275	mW	If= 15 x2 mA
Dominant wave length	X	0.28		0.30		If= 15 x 2 mA
	Y	0.28		0.30	-	
Luminous	LV	85			cd/m2	If= 15 x 2 mA
Luminous Uniformity	ΔLv	70			%	If= 15 x 2 mA

7. MAXIMUM ABSOLUTE POWER RATINGS

Item	Symbol	Standard value	Unit
Power supply voltage(1)	VDD	-0.3~+3.6	V
Power supply voltage(2)	VOUT,	-0.3 ~ 13.5	V
Power supply voltage(3)	VIN	-0.3 ~ V0	V
Operating temperature	Topr	-20~+70	°C
Storage temperature	Tstg	-30~+80	°C

8. ELECTRICAL CHARACTERISTICS**8-1 DC Characteristics**

Item	Symbol	Standard Value			Test Condition	Unit
		Min	Typ	Max		
Operating Voltage	V _{DD} -V _{SS}	2.8	3.1	3.3	TA=25°C	V
Supply Current	I _{DD}	----	TBD	5.0	--	mA
LCD Driving Voltage	V ₀ -V _{SS}	8.50	8.70	8.90	TA=25°C	V

8-2 AC Characteristics

8.2.3 Read/Write mode for 4-SPI Series MPU

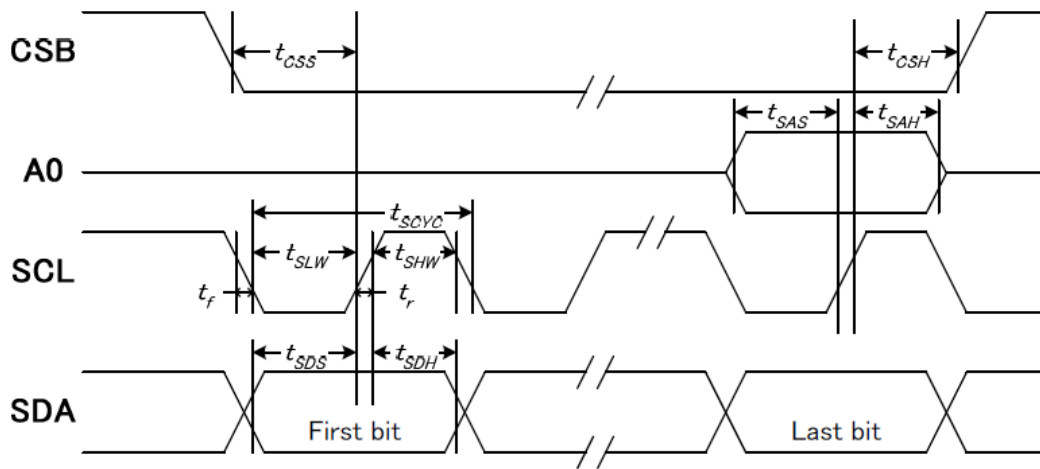

(VDD1 = 3.3V , Ta =25°C)

Item	Signal	Symbol	Condition	Min.	Max.	Unit
Serial clock period	SCLK	tSCYC		50	—	ns
SCLK "H" pulse width		tSHW		25	—	
SCLK "L" pulse width		tSLW		25	—	
Address setup time	A0	tSAS		20	—	
Address hold time		tSAH		10	—	
Data setup time	SDA	tSDS		20	—	
Data hold time		tSDH		10	—	
CSB-SCLK time	CSB	tCSS		20	—	
CSB-SCLK time		tCSH		40	—	

9. INSTRUCTION TABLE

INSTRUCTION	A0	R/W (RWR)	COMMAND BYTE								DESCRIPTION
			D7	D6	D5	D4	D3	D2	D1	D0	
(1) Display ON/OFF	0	0	1	0	1	0	1	1	1	D	D=1, display ON D=0, display OFF
(2) Set Start Line	0	0	0	1	S5	S4	S3	S2	S1	S0	Set display start line
(3) Set Page Address	0	0	1	0	1	1	Y3	Y2	Y1	Y0	Set page address
(4) Set Column Address	0	0	0	0	0	1	X7	X6	X5	X4	Set column address (MSB)
	0	0	0	0	0	0	X3	X2	X1	X0	Set column address (LSB)
(5) Read Status	0	1	0	MX	D	RST	0	0	0	0	Read IC Status
(6) Write Data	1	0	D7	D6	D5	D4	D3	D2	D1	D0	Write display data to RAM
(7) Read Data	1	1	D7	D6	D5	D4	D3	D2	D1	D0	Read display data from RAM
(8) SEG Direction	0	0	1	0	1	0	0	0	0	MX	Set scan direction of SEG MX=1, reverse direction MX=0, normal direction
(9) Inverse Display	0	0	1	0	1	0	0	1	1	INV	INV =1, inverse display INV =0, normal display
(10) All Pixel ON	0	0	1	0	1	0	0	1	0	AP	AP=1, set all pixel ON AP=0, normal display
(11) Bias Select	0	0	1	0	1	0	0	0	1	BS	Select bias setting 0=1/9; 1=1/7 (at 1/65 duty)
(12) Read-modify-Write	0	0	1	1	1	0	0	0	0	0	Column address increment: Read:+0 , Write:+1
(13) END	0	0	1	1	1	0	1	1	1	0	Exit Read-modify-Write mode
(14) RESET	0	0	1	1	1	0	0	0	1	0	Software reset
(15) COM Direction	0	0	1	1	0	0	MY	-	-	-	Set output direction of COM MY=1, reverse direction MY=0, normal direction
(16) Power Control	0	0	0	0	1	0	1	VB	VR	VF	Control built-in power circuit ON/OFF
(17) Regulation Ratio	0	0	0	0	1	0	0	RR2	RR1	RR0	Select regulation resistor ratio
(18) Set EV	0	0	1	0	0	0	0	0	0	1	Double command!! Set electronic volume (EV) level
	0	0	0	0	EV5	EV4	EV3	EV2	EV1	EV0	
(19) Set Booster	0	0	1	1	1	1	1	1	0	0	Double command!! Set booster level:
	0	0	0	0	0	0	0	0	0	0	BL=0: 4X BL=1: 5X
(20) Power Save	0	0	Compound Command								Display OFF + All Pixel ON
(21) NOP	0	0	1	1	1	0	0	0	1	1	No operation
(22) Test	0	0	1	1	1	1	1	1	1	-	Do NOT use. Reserved for testing.

Note: Symbol "-" means this bit can be "H" or "L".

10. Optical Characteristics

10.1 Definition of Viewing Angle

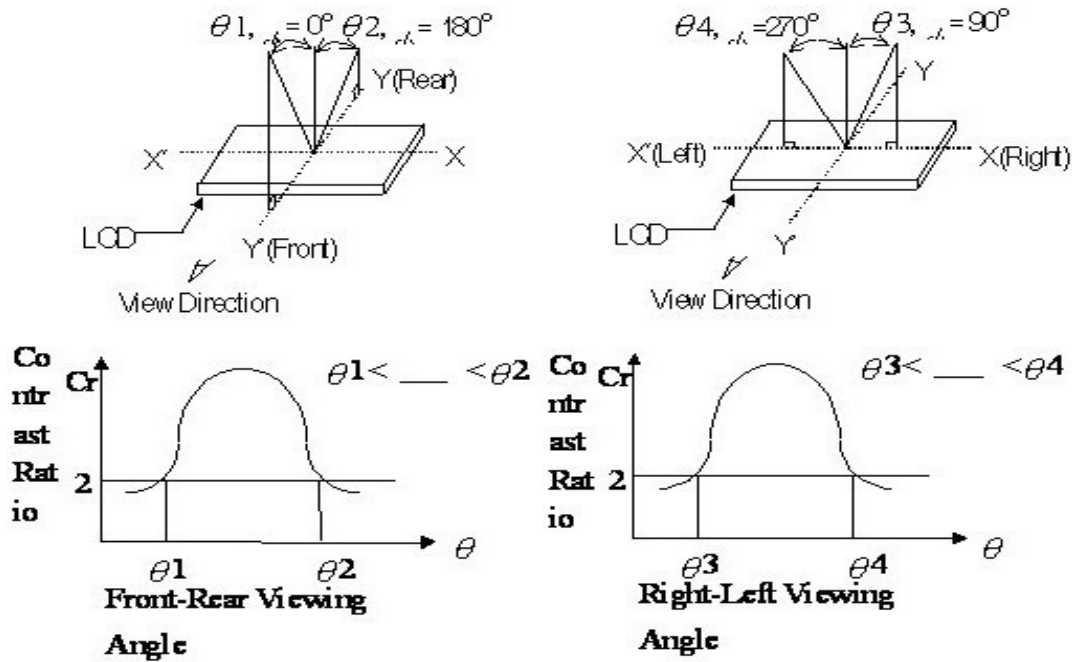

10.2 Definition of Contrast

$$C.R = \frac{\text{RATIO Brightness of nonselected segment (E2)}}{\text{Brightness of selected segment}}$$

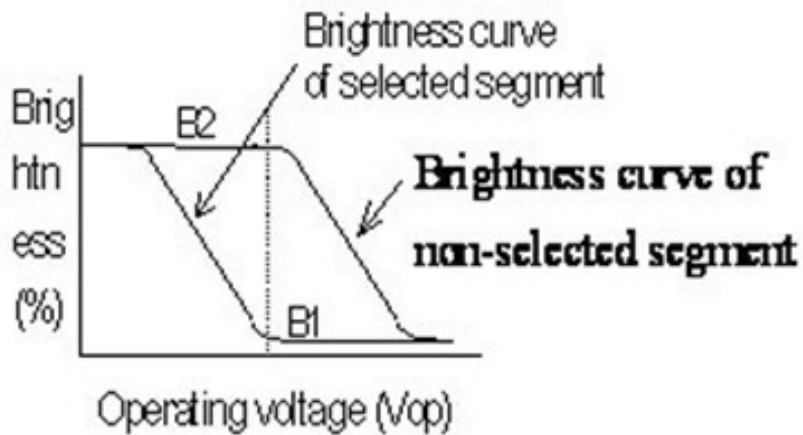

10.3 Definition of Response

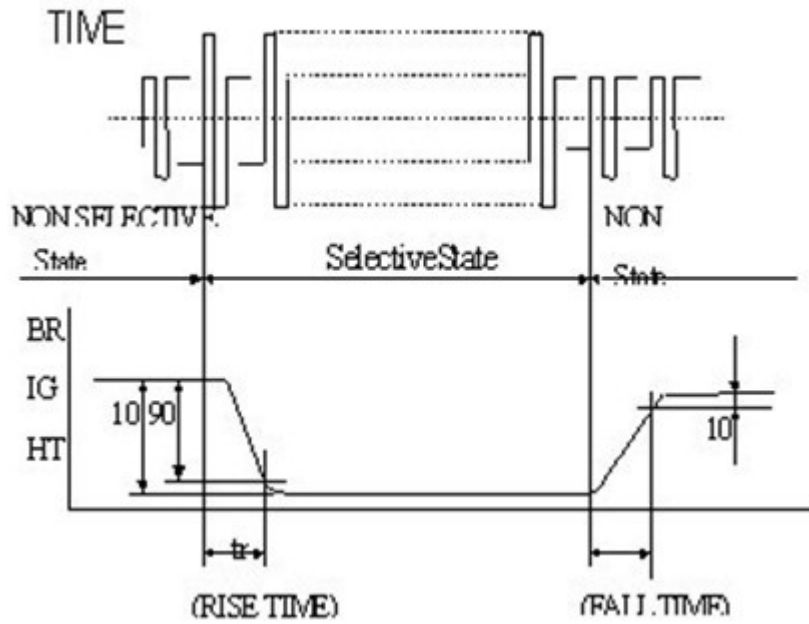

10.4 Measuring Instruments For Electro-optical Characteristics

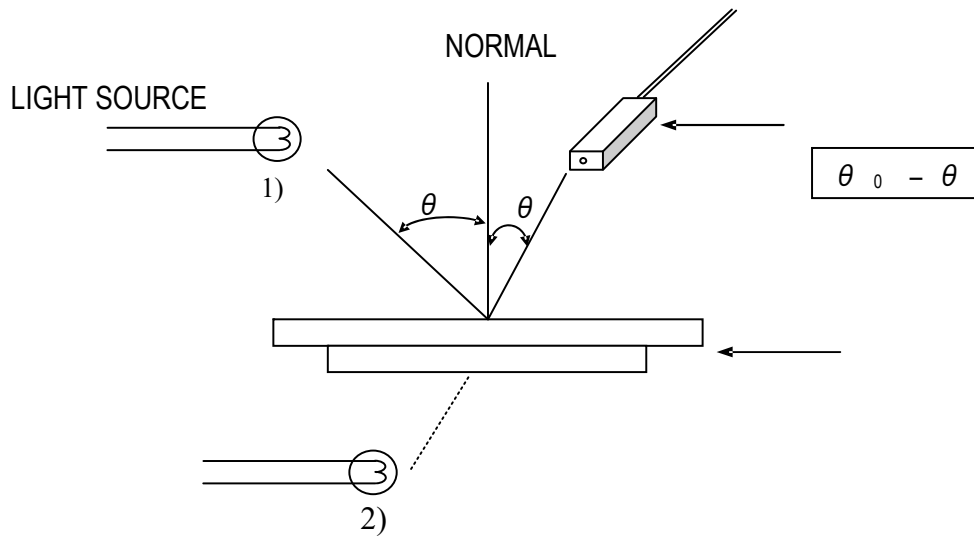

*** Note:**

- 1) Light source position for measuring the reflective type of LCD panel;
- 2) Light source position for measuring the transfective / transmissive types of LCD panel.

11. MODULE ACCEPT QUALITY LEVEL (AQL)

11.1 AQL Standard Value: Critical Defect =0.1, Major Defect=0.65; Minor Defect =2.5.

11.2 Inspection Standard: MIL-STD-105E Table Normal Inspection Single Sampling Level II

12. RELIABILITY TEST

Operating life time: Longer than 75,000 hours

(at room temperature without direct irradiation of sunlight)

Reliability characteristics shall meet following requirements.

No.	Test Item	Content of Test	Test Condition
1	High Temperature Storage	Endurance test applying the high storage temperature for a long time	+80°C 96H
2	Low Temperature Storage	Endurance test applying the low storage temperature for a long time	-30°C 96H
3	High Temperature Operation	Endurance test applying the electric stress (voltage & current) and the thermal stress to the element for a long time	+70°C 96H
4	Low Temperature Operation	Endurance test applying the electric stress under low temperature for a long time	-20°C 96H
5	High Temperature/ Humidity Storage	Endurance test applying the high temperature and humidity storage for a long time	60°C 90%RH 96H
6	Temperature Cycle	Endurance test applying the low and high temperature cycle $-20^{\circ}\text{C} \begin{matrix} \leftarrow \\ \rightarrow \end{matrix} 25^{\circ}\text{C} \begin{matrix} \leftarrow \\ \rightarrow \end{matrix} 70^{\circ}\text{C} \begin{matrix} \leftarrow \\ \rightarrow \end{matrix} 25^{\circ}\text{C}$ $30\text{min} \quad 5\text{min} \quad 30\text{min} \quad 5\text{min}$ $\begin{matrix} \leftarrow \\ \rightarrow \end{matrix}$ 1 cycle	-20°C/70°C 5 cycles
7	Vibration Test (Package State)	Endurance test applying the vibration during transportation	10Hz - 55Hz, 50m/s, 15min
8	Shock Test (Package State)	Endurance test applying the shock during transportation	Half-sinewave, 100m/s, 11ms
9	Atmospheric Pressure Test	Endurance test applying the atmospheric pressure during transportation by air	40 kPa 16 H

13. Inspection specification

13.1 Visual Inspection

- 1) Inspect under 2x20W or 40W fluorescent lamp (approximately 3000 lux) leaving 25 to 30 cm between the module and the lamp and 30 cm between the module and the eye (measuring position).
- 2) Appearance is inspected at the best contrast voltage (best contrast is adjusted considering clearness and crosstalk on screen).
- 3) Inspect the module at 45° right and left, top and bottom.
- 4) Use the optimum viewing angle during the contrast inspection.

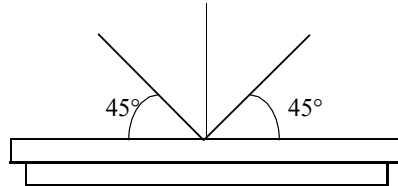

13.2 Standard of Appearance Inspection

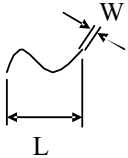
No.	Item	Criteria																		
1	Black spot White spot Dust	Round type: as per following drawing $\Phi = (X+Y)/2$  <table border="1" style="margin-left: 20px;"> <thead> <tr> <th colspan="3">Acceptable quantity</th> </tr> <tr> <th>Size</th> <th>Zone A</th> <th>Zone B</th> </tr> </thead> <tbody> <tr> <td>$\Phi < 0.1$</td> <td>Any number</td> <td rowspan="4">Any number</td> </tr> <tr> <td>$0.1 < \Phi < 0.2$</td> <td>2</td> </tr> <tr> <td>$0.2 < \Phi < 0.25$</td> <td>1</td> </tr> <tr> <td>$0.25 < \Phi$</td> <td>0</td> </tr> </tbody> </table>	Acceptable quantity			Size	Zone A	Zone B	$\Phi < 0.1$	Any number	Any number	$0.1 < \Phi < 0.2$	2	$0.2 < \Phi < 0.25$	1	$0.25 < \Phi$	0			
		Acceptable quantity																		
Size	Zone A	Zone B																		
$\Phi < 0.1$	Any number	Any number																		
$0.1 < \Phi < 0.2$	2																			
$0.2 < \Phi < 0.25$	1																			
$0.25 < \Phi$	0																			
Line type: as per following drawing <table border="1" style="margin-left: 20px;"> <thead> <tr> <th colspan="4">Acceptable quantity</th> </tr> <tr> <th>Length</th> <th>Width</th> <th>Zone A</th> <th>Zone B</th> </tr> </thead> <tbody> <tr> <td>—</td> <td>$W \leq 0.02$</td> <td>Any number</td> <td rowspan="4">Any number</td> </tr> <tr> <td>$L \leq 3.0$</td> <td>$0.02 < W \leq 0.03$</td> <td rowspan="2">2</td> </tr> <tr> <td>$L \leq 2.5$</td> <td>$0.03 < W \leq 0.05$</td> </tr> <tr> <td>—</td> <td>$0.05 < W$</td> <td>As round type</td> </tr> </tbody> </table> 	Acceptable quantity				Length	Width	Zone A	Zone B	—	$W \leq 0.02$	Any number	Any number	$L \leq 3.0$	$0.02 < W \leq 0.03$	2	$L \leq 2.5$	$0.03 < W \leq 0.05$	—	$0.05 < W$	As round type
Acceptable quantity																				
Length	Width	Zone A	Zone B																	
—	$W \leq 0.02$	Any number	Any number																	
$L \leq 3.0$	$0.02 < W \leq 0.03$	2																		
$L \leq 2.5$	$0.03 < W \leq 0.05$																			
—	$0.05 < W$	As round type																		
		Total acceptable quantity: 3																		
2	Polariser	Scratch on protective film is permitted																		

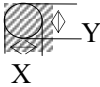
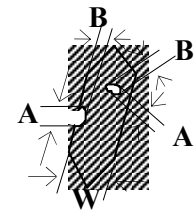
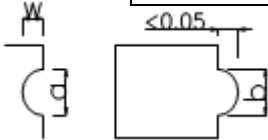
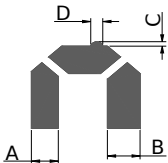
<p>3</p>	<p>scratch</p> <p>Polariser bubble</p>	<p>Scratch on polariser: same as No. 1</p> <p>$\Phi = (X+Y)/2$</p>  <p>Total acceptable quantity: 3</p> <table border="1" data-bbox="869 315 1399 853"> <thead> <tr> <th colspan="3">Acceptable quantity</th> </tr> <tr> <th>Size</th> <th>Zone A</th> <th>Zone B</th> </tr> </thead> <tbody> <tr> <td>$\Phi < 0.2$</td> <td>Any number</td> <td rowspan="4">Any number</td> </tr> <tr> <td>$0.2 < \Phi < 0.5$</td> <td>2</td> </tr> <tr> <td>$0.5 < \Phi < 1.0$</td> <td>1</td> </tr> <tr> <td>$1.0 < \Phi$</td> <td>0</td> </tr> </tbody> </table>	Acceptable quantity			Size	Zone A	Zone B	$\Phi < 0.2$	Any number	Any number	$0.2 < \Phi < 0.5$	2	$0.5 < \Phi < 1.0$	1	$1.0 < \Phi$	0													
Acceptable quantity																														
Size	Zone A	Zone B																												
$\Phi < 0.2$	Any number	Any number																												
$0.2 < \Phi < 0.5$	2																													
$0.5 < \Phi < 1.0$	1																													
$1.0 < \Phi$	0																													
<p>4</p>	<p>Segment deformation</p>	<p>4.1 Pin hole on segmented display</p> <p>W: segment width</p> <p>$\Phi = (A+B)/2$</p>  <table border="1" data-bbox="807 992 1399 1361"> <thead> <tr> <th colspan="2">Acceptable quantity</th> </tr> <tr> <th>Width</th> <th>Quantity</th> </tr> </thead> <tbody> <tr> <td>$W \leq 0.4$</td> <td>$\Phi \leq 0.2$ and $\Phi \leq 1/2W$</td> </tr> <tr> <td>$W > 0.4$</td> <td>$\Phi \leq 0.25$ and $\Phi \leq 1/3W$</td> </tr> <tr> <td colspan="2">Total acceptable quantity: 1 defect per segment</td> </tr> <tr> <td colspan="2">Pin holes with Φ under 0.10 mm are acceptable</td> </tr> </tbody> </table> <p>4.2 Pin hole on</p>  <table border="1" data-bbox="1010 1424 1399 1960"> <thead> <tr> <th colspan="2">Acceptable quantity</th> </tr> <tr> <th>Size</th> <th>Quantity</th> </tr> </thead> <tbody> <tr> <td>$a, b < 0.1$</td> <td>Any number</td> </tr> <tr> <td>$(a+b)/2 \leq 0.1$</td> <td>Any number</td> </tr> <tr> <td>$0.5 < \Phi < 1.0$</td> <td>3</td> </tr> </tbody> </table> <p>Total acceptable quantity: 7</p> <p>4.3 Segments / dots with different</p>  <p>4.4 Alignment layer defect</p> <p>$\Phi = (A+B)/2$</p> <table border="1" data-bbox="963 1960 1318 2074"> <thead> <tr> <th colspan="2">Acceptable</th> </tr> </thead> <tbody> <tr> <td>$a \geq b$</td> <td>$a/b \leq 4/3$</td> </tr> <tr> <td>$a < b$</td> <td>$a/b > 4/3$</td> </tr> </tbody> </table>	Acceptable quantity		Width	Quantity	$W \leq 0.4$	$\Phi \leq 0.2$ and $\Phi \leq 1/2W$	$W > 0.4$	$\Phi \leq 0.25$ and $\Phi \leq 1/3W$	Total acceptable quantity: 1 defect per segment		Pin holes with Φ under 0.10 mm are acceptable		Acceptable quantity		Size	Quantity	$a, b < 0.1$	Any number	$(a+b)/2 \leq 0.1$	Any number	$0.5 < \Phi < 1.0$	3	Acceptable		$a \geq b$	$a/b \leq 4/3$	$a < b$	$a/b > 4/3$
Acceptable quantity																														
Width	Quantity																													
$W \leq 0.4$	$\Phi \leq 0.2$ and $\Phi \leq 1/2W$																													
$W > 0.4$	$\Phi \leq 0.25$ and $\Phi \leq 1/3W$																													
Total acceptable quantity: 1 defect per segment																														
Pin holes with Φ under 0.10 mm are acceptable																														
Acceptable quantity																														
Size	Quantity																													
$a, b < 0.1$	Any number																													
$(a+b)/2 \leq 0.1$	Any number																													
$0.5 < \Phi < 1.0$	3																													
Acceptable																														
$a \geq b$	$a/b \leq 4/3$																													
$a < b$	$a/b > 4/3$																													

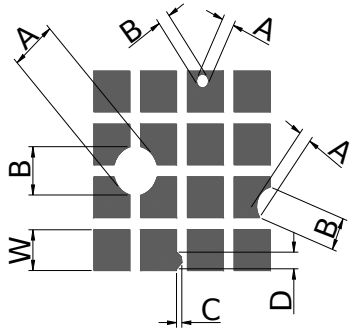
		 <p>Total acceptable quantity: 7</p> <table border="1" data-bbox="970 257 1327 878"> <thead> <tr> <th colspan="2">Acceptable quantity</th> </tr> <tr> <th>Size</th> <th>Quantity</th> </tr> </thead> <tbody> <tr> <td>$\Phi \leq 0.4$</td> <td>Any number</td> </tr> <tr> <td>$0.4 < \Phi \leq 1.0$</td> <td>5</td> </tr> <tr> <td>$1.0 < \Phi \leq 1.5$</td> <td>3</td> </tr> <tr> <td>$1.5 < \Phi \leq 2.0$</td> <td>2</td> </tr> </tbody> </table>	Acceptable quantity		Size	Quantity	$\Phi \leq 0.4$	Any number	$0.4 < \Phi \leq 1.0$	5	$1.0 < \Phi \leq 1.5$	3	$1.5 < \Phi \leq 2.0$	2				
Acceptable quantity																		
Size	Quantity																	
$\Phi \leq 0.4$	Any number																	
$0.4 < \Phi \leq 1.0$	5																	
$1.0 < \Phi \leq 1.5$	3																	
$1.5 < \Phi \leq 2.0$	2																	
5	Colour uniformity	Level of sample for approval set as limit sample																
6	Backlight	The backlight colour should correspond to the product specification Flashing and or unlit backlight is not allowed Dust larger than 0.25 mm is not allowed																
7	COB	Exposed wire bond pad is not allowed Insufficient covering with resin is not allowed (wire bond line exposed) Dust or bubble on the resin are not allowed																
8	PCB	No unmelted solder paste should be present on PCB Cold solder joints, missing solder connections, or oxidation are not allowed No residue or solder balls on PCB are allowed Short circuits on components are not allowed																
9	Tray particles	<table border="1" data-bbox="705 1400 1248 1977"> <thead> <tr> <th colspan="3">Acceptable quantity</th> </tr> <tr> <th></th> <th>Size</th> <th>Quantity</th> </tr> </thead> <tbody> <tr> <td rowspan="2">On tray</td> <td>$\Phi < 0.2$</td> <td>Any number</td> </tr> <tr> <td>$\Phi > 0.25$</td> <td>4</td> </tr> <tr> <td rowspan="2">On display</td> <td>$\Phi \geq 0.25$</td> <td>2</td> </tr> <tr> <td>$L = 3$</td> <td>1</td> </tr> </tbody> </table>	Acceptable quantity				Size	Quantity	On tray	$\Phi < 0.2$	Any number	$\Phi > 0.25$	4	On display	$\Phi \geq 0.25$	2	$L = 3$	1
Acceptable quantity																		
	Size	Quantity																
On tray	$\Phi < 0.2$	Any number																
	$\Phi > 0.25$	4																
On display	$\Phi \geq 0.25$	2																
	$L = 3$	1																

14. LCD MODULES HANDLING PRECAUTIONS

- Please remove the protection foil of polarizer before using.
- The display panel is made of glass. Do not subject it to a mechanical shock by dropping it from a high place, etc.
- If the display panel is damaged and the liquid crystal substance inside it leaks out, do not get any in your mouth. If the substance come into contact with your skin or clothes promptly wash it off using soap and water.
- Do not apply excessive force to the display surface or the adjoining areas since this may cause the color tone to vary.
- The polarizer covering the display surface of the LCD module is soft and easily scratched. Handle this polarize carefully.
- To prevent destruction of the elements by static electricity, be careful to maintain an optimum work environment.
 - Be sure to ground the body when handling the LCD module.
 - Tools required for assembly, such as soldering irons, must be properly grounded.
 - To reduce the amount of static electricity generated, do not conduct assembly and other work under dry conditions.
 - The LCD module is coated with a film to protect the display surface. Exercise care when peeling off this protective film since static electricity may be generated.
- Storage precautions
When storing the LCD modules, avoid exposure to direct sunlight or to the light of fluorescent lamps. Keep the modules in bags designed to prevent static electricity charging under low temperature / normal humidity conditions (avoid high temperature / high humidity and low temperatures below 0 °C).Whenever possible, the LCD modules should be stored in the same conditions in which they were shipped from our company.

15. OTHERS

- Liquid crystals solidify at low temperature (below the storage temperature range) leading to defective orientation of liquid crystal or the generation of air bubbles (black or white). Air bubbles may also be generated if the module is subjected to a strong shock at a low temperature.
- If the LCD modules have been operating for a long time showing the same display patterns may remain on the screen as ghost images and a slight contrast irregularity may also appear. Abnormal operating status can be resumed to be normal condition by suspending use for some time. It should be noted that this phenomena does not adversely affect performance reliability.
- To minimize the performance degradation of the LCD modules resulting from caused by static electricity, etc. exercise care to avoid holding the following sections when handling the modules:
 - Exposed area of the printed circuit board
 - Terminal electrode sections