

BZX84C

ZENER DIODE

FEATURES

- ⌘ Planar Die Construction
- ⌘ 300mW Power Dissipation
- ⌘ Zener Voltages from 2.4V - 43V
- ⌘ Ultra-Small Surface Mount Package Power Dissipation

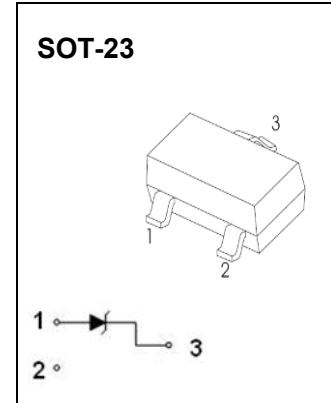

Maximum Ratings ($T_a=25^\circ\text{C}$ unless otherwise specified)

Characteristic	Symbol	Value	Unit
Forward Voltage (Note 2) @ $I_F=10\text{mA}$	V_F	0.9	V
Power Dissipation (Note 1)	P_d	300	mW
Thermal Resistance from Junction to Ambient	$R_{\theta JA}$	417	$^\circ\text{C/W}$
Junction Temperature	T_j	150	$^\circ\text{C}$
Storage Temperature Range	T_{stg}	-55~+150	$^\circ\text{C}$

ELECTRICAL CHARACTERISTICS

T_a=25°C unless otherwise specified

Type Number	Code	Zener Voltage Range (Note 2)				Maximum Zener Impedance (Note 3)			Maximum Reverse Current		Temperature Coefficient of Zener voltage @ I _{ZT} =5mA mV/°C	
		V _Z @I _{ZT}			I _{ZT}	Z _{ZT} @I _{ZT}	Z _{ZK} @I _{ZK}	I _{ZK}	I _R	V _R	Min	Max
		Nom(V)	Min(V)	Max(V)	(mA)	(Ω)		(mA)	(μA)	(V)		
BZX84C2V4	Z11	2.4	2.20	2.60	5	100	600	1.0	50	1.0	-3.5	0
BZX84C2V7	Z12	2.7	2.5	2.9	5	100	600	1.0	20	1.0	-3.5	0
BZX84C3V0	Z13	3.0	2.8	3.2	5	95	600	1.0	10	1.0	-3.5	0
BZX84C3V3	Z14	3.3	3.1	3.5	5	95	600	1.0	5	1.0	-3.5	0
BZX84C3V6	Z15	3.6	3.4	3.8	5	90	600	1.0	5	1.0	-3.5	0
BZX84C3V9	Z16	3.9	3.7	4.1	5	90	600	1.0	3	1.0	-3.5	0
BZX84C4V3	Z17	4.3	4.0	4.6	5	90	600	1.0	3	1.0	-3.5	0
BZX84C4V7	Z1	4.7	4.4	5.0	5	80	500	1.0	3	2.0	-3.5	0.2
BZX84C5V1	Z2	5.1	4.8	5.4	5	60	480	1.0	2	2.0	-2.7	1.2
BZX84C5V6	Z3	5.6	5.2	6.0	5	40	400	1.0	1	2.0	-2.0	2.5
BZX84C6V2	Z4	6.2	5.8	6.6	5	10	150	1.0	3	4.0	0.4	3.7
BZX84C6V8	Z5	6.8	6.4	7.2	5	15	80	1.0	2	4.0	1.2	4.5
BZX84C7V5	Z6	7.5	7.0	7.9	5	15	80	1.0	1	5.0	2.5	5.3
BZX84C8V2	Z7	8.2	7.7	8.7	5	15	80	1.0	0.7	5.0	3.2	6.2
BZX84C9V1	Z8	9.1	8.5	9.6	5	15	100	1.0	0.5	6.0	3.8	7.0
BZX84C10	Z9	10	9.4	10.6	5	20	150	1.0	0.2	7.0	4.5	8.0
BZX84C11	Y1	11	10.4	11.6	5	20	150	1.0	0.1	8.0	5.4	9.0
BZX84C12	Y2	12	11.4	12.7	5	25	150	1.0	0.1	8.0	6.0	10.0
BZX84C13	Y3	13	12.4	14.1	5	30	170	1.0	0.1	8.0	7.0	11.0
BZX84C15	Y4	15	13.8	15.6	5	30	200	1.0	0.1	10.5	9.2	13.0
BZX84C16	Y5	16	15.3	17.1	5	40	200	1.0	0.1	11.2	10.4	14.0
BZX84C18	Y6	18	16.8	19.1	5	45	225	1.0	0.1	12.6	12.4	16.0
BZX84C20	Y7	20	18.8	21.2	5	55	225	1.0	0.1	14.0	14.4	18.0
BZX84C22	Y8	22	20.8	23.3	5	55	250	1.0	0.1	15.4	16.4	20.0
BZX84C24	Y9	24	22.8	25.6	5	70	250	1.0	0.1	16.8	18.4	22.0
BZX84C27	Y10	27	25.1	28.9	2	80	300	0.5	0.1	18.9	21.4	25.3
BZX84C30	Y11	30	28.0	32.0	2	80	300	0.5	0.1	21.0	24.4	29.4
BZX84C33	Y12	33	31.0	35.0	2	80	325	0.5	0.1	23.1	27.4	33.4
BZX84C36	Y13	36	34.0	38.0	2	90	350	0.5	0.1	25.2	30.4	37.4
BZX84C39	Y14	39	37.0	41.0	2	130	350	0.5	0.1	27.3	33.4	41.2
BZX84C43	Y15	43	40.0	46.0	2	100	700	1	0.1	32	10	12

- Notes:
1. Valid provided that device terminals are kept at ambient temperature.
 2. Tested with pulses, period=5ms,pulse width =300μs.
 3. f = 1kHz.

ELECTRICAL CHARACTERISTICS

Zener Characteristics (V_Z Up to 10 V)

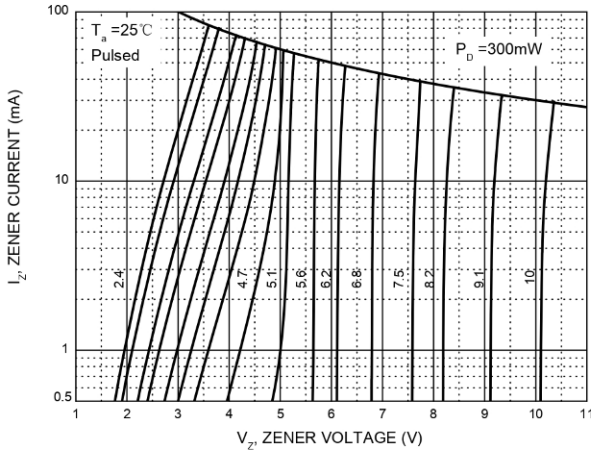

Zener Characteristics (11 V to 43 V)

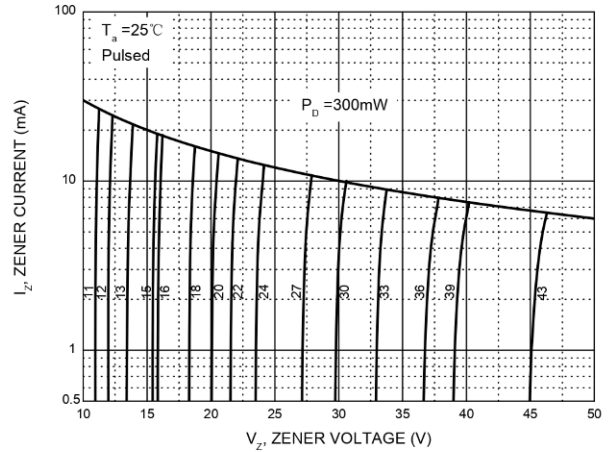

Temperature Coefficients

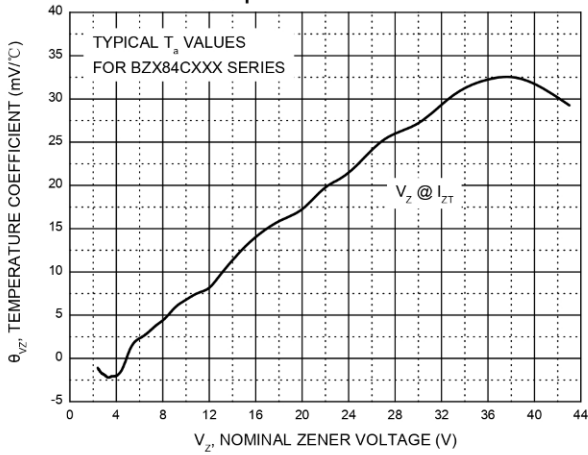

Typical Leakage Current

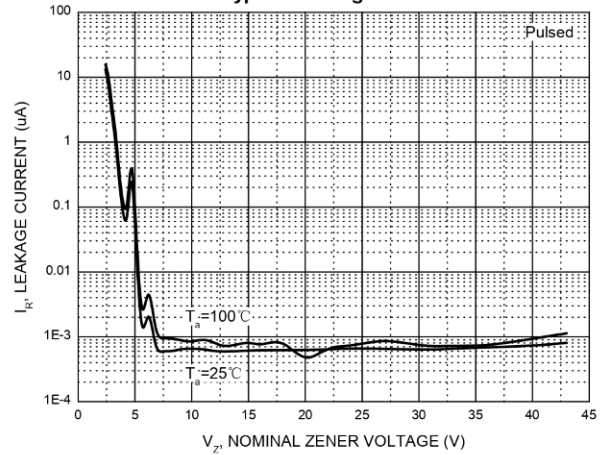

Typical Capacitance

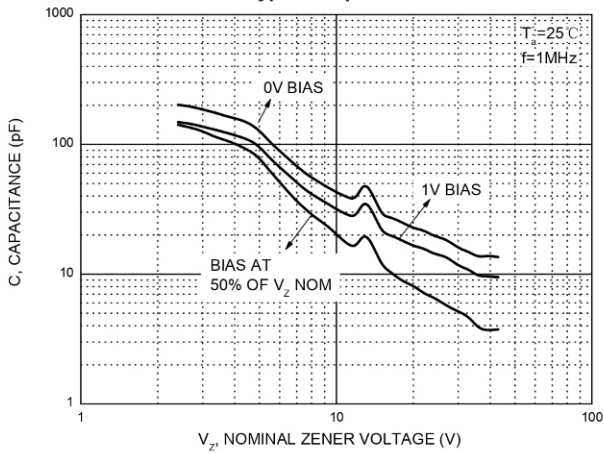

Effect of Zener Voltage on Zener Impedance

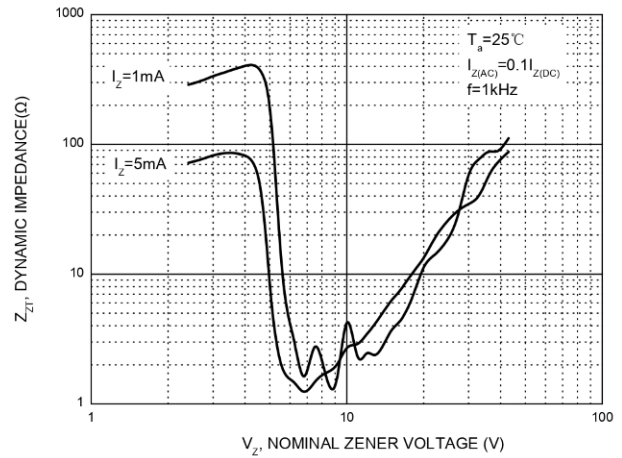

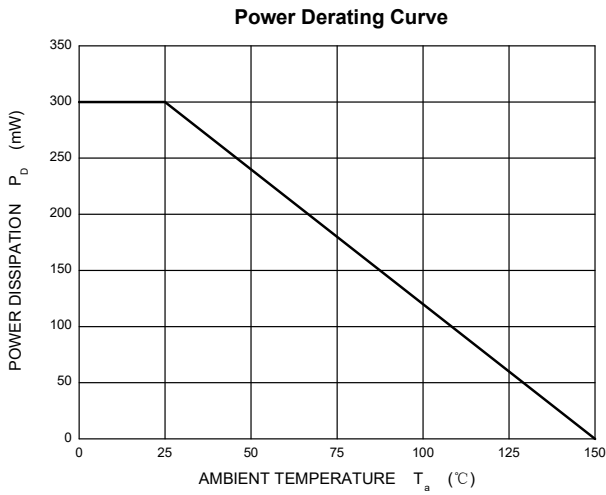

SOT-23 Package Outline Dimensions

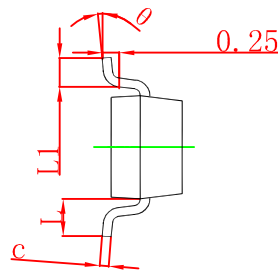
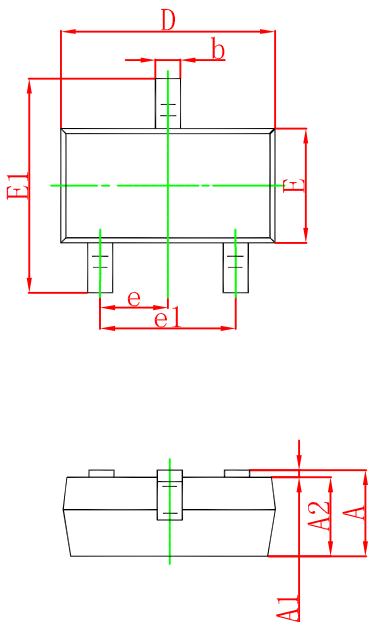

Symbol	Dimensions In Millimeters		Dimensions In Inches	
	Min	Max	Min	Max
A	0.900	1.150	0.035	0.045
A1	0.000	0.100	0.000	0.004
A2	0.900	1.050	0.035	0.041
b	0.300	0.500	0.012	0.020
c	0.080	0.150	0.003	0.006
D	2.800	3.000	0.110	0.118
E	1.200	1.400	0.047	0.055
E1	2.250	2.550	0.089	0.100
e	0.950 TYP		0.037 TYP	
e1	1.800	2.000	0.071	0.079
L	0.550 REF		0.022 REF	
L1	0.300	0.500	0.012	0.020
θ	0°	8°	0°	8°