

Micro Switch

Q-10194

TYPE: **MSW-08**

SPECIFICATIONS

Rating: 16A 125/250V AC
Contact R: 20mΩ max
Insulation R: 500V DC 100MΩ min
Dielectric Strength: 1 Minute 1500V AC
Operating Temperature: -25°C ~ +85°C
Electrical Life: 100, 000 Cycles

Outline Drawing

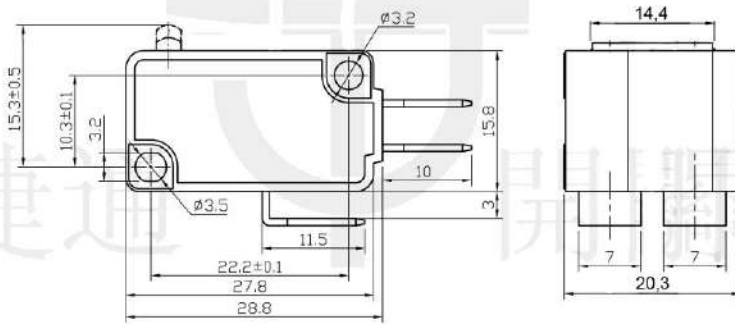

Mounting

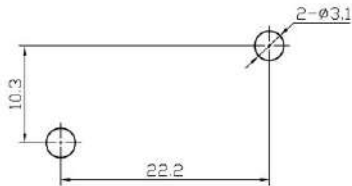

Circuitry

