

DATA SHEET

SKY65933-11: GNSS Low-Noise Amplifier Front-End Module with integrated Pre-Filter and Post-Filter

Applications

- Wearables
- Actions cameras
- Drones
- Personal navigation devices
- GNSS radio receivers

Features

- Small signal gain: 14.5 dB
- In-band IIP3: -8 dBm
- Low noise figure: 1.9 dB
- Low current consumption: 2.9 mA @ 1.8 V
- Shut-down current: 0.1 uA
- Input/output impedance internally matched to 50 Ω
- Single DC supply: 1.5 to 2.85 V
- No external matching components required
- Pin-to-pin compatible with SKY65903-11
- Small MCM (16-pin, 2.5 x 2.5 mm) package (MSL3, 260 °C per JEDEC J-STD-020)



Skyworks Green™ products are compliant with all applicable legislation and are halogen-free. For additional information, refer to *Skyworks Definition of Green™*, document number SQ04-0074.

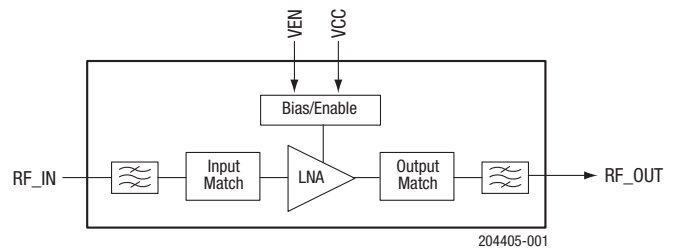

Figure 1. SKY65933-11 Block Diagram

Description

The SKY65933-11 is a front-end module (FEM) with an integrated low-noise amplifier (LNA), pre-filter, and post-filter designed for Global Navigation Satellite System receiver applications. The device fully integrates all input and output matching components to simplify PCB designs. The pre-filter and post-filter provide low in-band insertion loss and excellent rejection for the cellular, PCS, and WLAN frequency bands. The device also features a single-pin enable and an extremely low shut-down current when disabled.

The SKY65933-11 is optimized to operate at 1559 to 1606 MHz, which makes it ideal for GPS/GLONASS/Galileo/Compass/QZSS radio receiver applications.

The SKY65933-11 uses surface-mount technology (SMT) in the form of a 2.5 x 2.5 mm Multi-Chip Module (MCM) package, which allows for a highly manufacturable and low-cost solution.

A functional block diagram is shown in Figure 1. The pin configuration and package are shown in Figure 2. Signal pin assignments and functional pin descriptions are provided in Table 1.

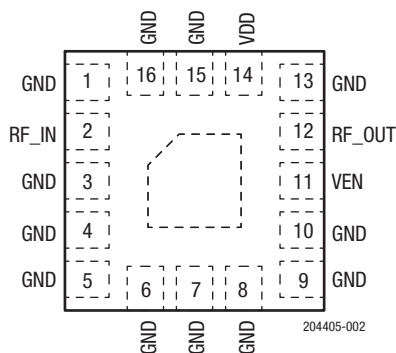

Figure 2. SKY65933-11 Pinout (Top View)

Table 1. SKY65933-11 Signal Descriptions

| Pin | Name | Description | Pin | Name | Description |
|-----|-------|-------------|-----|--------|------------------|
| 1 | GND | Ground | 9 | GND | Ground |
| 2 | RF_IN | RF input | 10 | GND | Ground |
| 3 | GND | Ground | 11 | VEN | LNA enable |
| 4 | GND | Ground | 12 | RF_OUT | RF output |
| 5 | GND | Ground | 13 | GND | Ground |
| 6 | GND | Ground | 14 | VCC | LNA power supply |
| 7 | GND | Ground | 15 | GND | Ground |
| 8 | GND | Ground | 16 | GND | Ground |

Technical Description

LNA Enable

The VEN signal (pin 11) enables or disables the LNA. A logic high signal powers on the LNA, and a logic low signal powers off the device.

Electrical and Mechanical Specifications

The absolute maximum ratings of the SKY65933-11 are provided in Table 2. The recommended operating conditions are specified in Table 3. Electrical specifications for 1.8 V and 2.8 V operation are shown in Table 4 and Table 5, respectively.

Table 2. SKY65933-11 Absolute Maximum Ratings¹

| Parameter | Symbol | Minimum | Maximum | Units |
|--|------------------|---------|---------|-------|
| RF input power | P _{IN} | | +10 | dBm |
| Supply voltage | V _{CC} | 0 | 3.1 | V |
| Storage temperature | T _{STG} | -55 | +150 | °C |
| Junction temperature | T _J | | +150 | °C |
| Electrostatic discharge: Human Body Model (HBM), Class 1A | ESD | | 250 | V |

¹ Exposure to maximum rating conditions for extended periods may reduce device reliability. There is no damage to device with only one parameter set at the limit and all other parameters set at or below their nominal value. Exceeding any of the limits listed here may result in permanent damage to the device.

ESD HANDLING: Although this device is designed to be as robust as possible, electrostatic discharge (ESD) can damage this device. This device must be protected at all times from ESD when handling or transporting. Static charges may easily produce potentials of several kilovolts on the human body or equipment, which can discharge without detection. Industry-standard ESD handling precautions should be used at all times.

Table 3. SKY65933-11 Recommended Operating Conditions

| Parameter | Symbol | Min | Typ | Max | Units |
|------------------|------------------------|-----------------------|------|-----------------|-------|
| Frequency | f | 1559 | 1575 | 1606 | MHz |
| Supply voltage | V _{CC} | 1.5 | 1.8 | 2.85 | V |
| LNA enable: | | | | | |
| Enable (high) | LNAENABLE | V _{CC} - 0.3 | | V _{CC} | V |
| Disable (low) | LNA _{DISABLE} | | 0 | 0.3 | V |
| Case temperature | T _C | -40 | +25 | +85 | °C |

Table 4. SKY65933-11 Electrical Specifications¹
(V_{CC} = 1.8 V, V_{EN} = 1.8 V, f = 1575 MHz, T_c = +25°C, Unless Otherwise Noted)

| Parameter | Symbol | Test Condition | Min | Typ | Max | Units |
|---|-------------------|--|----------------------|----------------------|-------------------|-------------------|
| Small signal gain | IS21I | P _{IN} = -30 dBm: @ 1559 MHz @ 1575 MHz @ 1606 MHz | 11.0 12.0 10.5 | 13.0 14.0 13.0 | | dB dB dB |
| Noise figure | NF | @ 1559 MHz @ 1575 MHz @ 1606 MHz | | 2.3 1.9 2.3 | 2.6 2.5 3.0 | dB dB dB |
| In-band third order input intercept point | IIP3 | f ₁ = 1575 MHz @ P _{IN} = -30 dBm f ₂ = 1576 MHz @ P _{IN} = -30 dBm | | -8 | | dBm |
| 1 dB input compression point (in-band) | IP1dB | | | -13 | | dBm |
| Reverse isolation | IS12I | P _{IN} = -30 dBm | | 42 | | dB |
| Input return loss | IS11I | P _{IN} = -30 dBm | | 8 | | dB |
| Output return loss | IS22I | P _{IN} = -30 dBm | | 20 | | dB |
| Supply current | I _{CC} | No RF | | 2.9 | 4.0 | mA |
| Shut-down current | I _{LEAK} | No RF, V _{EN} = 0 V | | 0.1 | 1.0 | μA |
| Out-of-band rejection | OOB | P _{IN} = 0 dBm (in-band referred): @ 806 to 928 MHz @1710 to 1980 MHz @2400 to 2500 MHz | | 95 80 75 | | dBc dBc dBc |

¹ Performance is guaranteed only under the conditions listed in this table.

Table 5. SKY65933-11 Electrical Specifications¹
(V_{CC} = 2.8 V, V_{EN} = 2.8 V, f = 1575 MHz, T_c = +25°C, Unless Otherwise Noted)

| Parameter | Symbol | Test Condition | Min | Typ | Max | Units |
|---|-------------------|--|----------------------|--------------------|-----|-------------------|
| Small signal gain | IS21I | P _{IN} = -30 dBm: @ 1559 MHz @ 1575 MHz @ 1606 MHz | 12.0 12.5 11.5 | 14 14.5 13.5 | | dB dB dB |
| Noise figure | NF | @ 1559 MHz @ 1575 MHz @ 1606 MHz | | 2.3 1.9 2.3 | | dB dB dB |
| In-band third order input intercept point | IIP3 | f ₁ = 1575 MHz @ P _{IN} = -30 dBm f ₂ = 1576 MHz @ P _{IN} = -30 dBm | | -8 | | dBm |
| 1 dB input compression point (in-band) | IP1dB | | | -10 | | dBm |
| Reverse isolation | IS12I | P _{IN} = -30 dBm | | 42 | | dB |
| Input return loss | IS11I | P _{IN} = -30 dBm | | 8 | | dB |
| Output return loss | IS22I | P _{IN} = -30 dBm | | 20 | | dB |
| Supply current | I _{CC} | No RF | | 3 | 4 | mA |
| Shut-down current | I _{LEAK} | No RF, V _{EN} = 0 V | | 0.1 | 1.0 | μA |
| Out-of-band rejection | OOB | P _{IN} = 0 dBm (in-band referred): @ 806 to 928 MHz @1710 to 1980 MHz @2400 to 2500 MHz | | 95 80 75 | | dBc dBc dBc |

¹ Performance is guaranteed only under the conditions listed in this table.

Evaluation Board Description

The SKY65933-11 Evaluation Board is used to test the performance of the SKY65933-11 LNA. The Evaluation Board schematic diagram is shown in Figure 3.

The Evaluation Board physical layer details are shown in Figure 4. Table 5 provides the Bill of Materials (BOM) list for the Evaluation Board components.

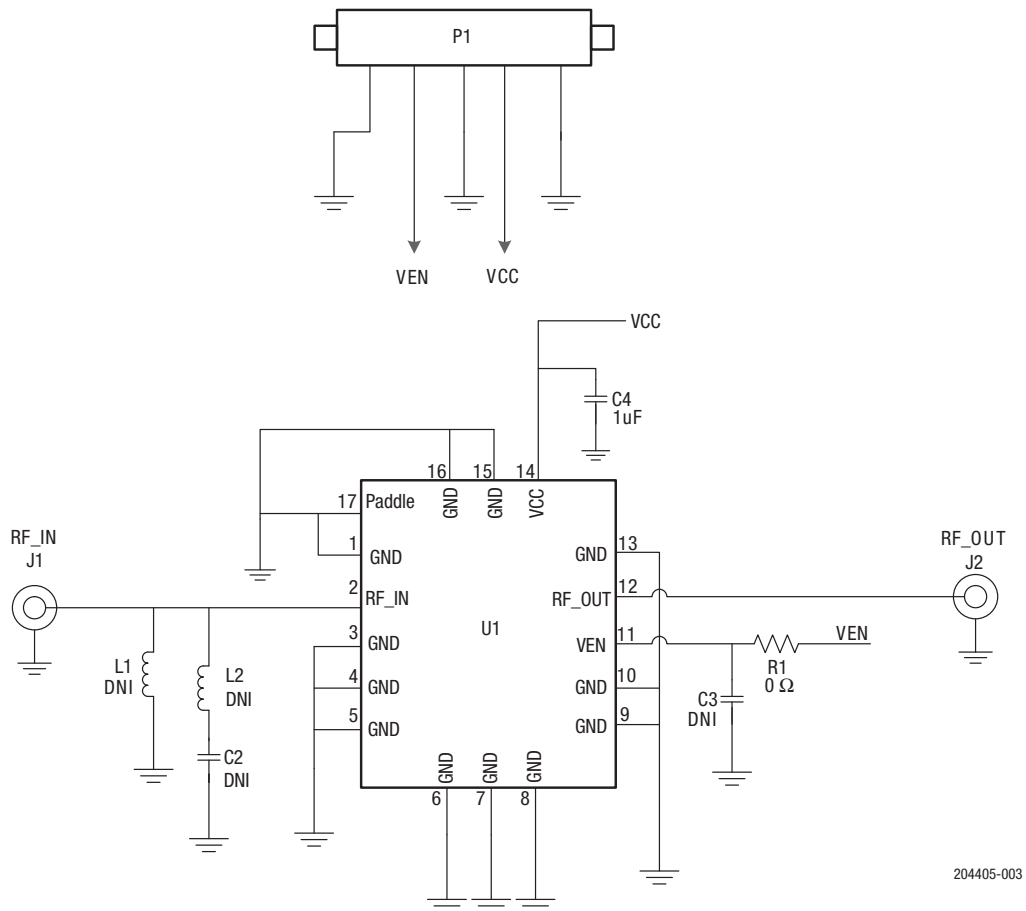
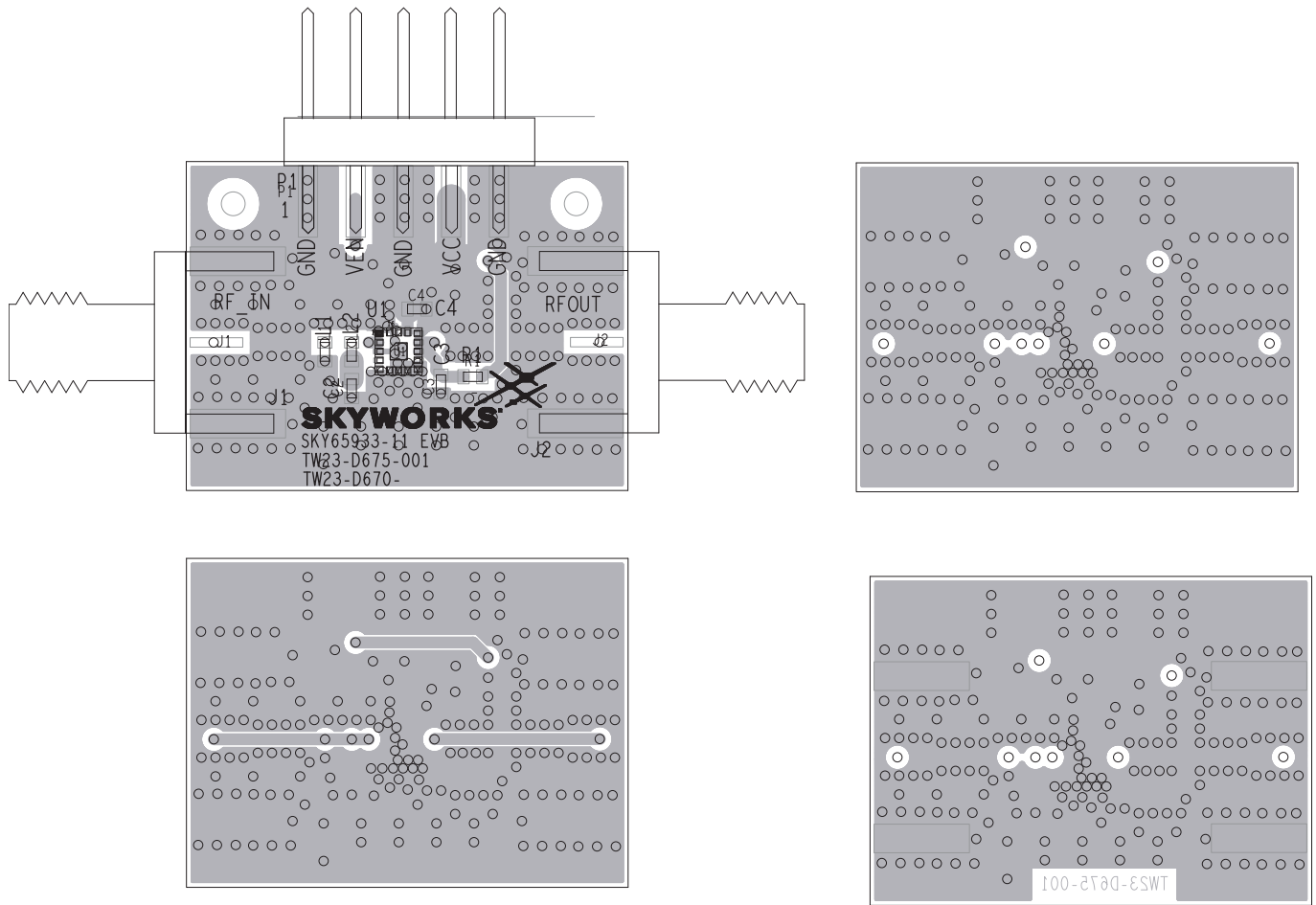

Figure 3. SKY65933-11 Evaluation Board Schematic

204405-003



204405-004

Figure 4. SKY65933-11 Evaluation Board Assembly Diagram

Table 5. SKY65933-11 Evaluation Board Bill of Materials

| Component | Size | Value |
|--------------------|------|------------|
| L1, L2, C2, and C3 | 0402 | DNI |
| C4 | 0402 | 1 μ F |
| R1 | 0402 | 0 Ω |

Package Dimensions

The PCB layout footprint for the SKY65933-11 is provided in Figure 5. Typical part markings are shown in Figure 6. Package dimensions are shown in Figure 7, and tape and reel dimensions are provided in Figure 8.

Package and Handling Information

Since the device package is sensitive to moisture absorption, it is baked and vacuum packed before shipping. Instructions on the shipping container label regarding exposure to moisture after the container seal is broken must be followed. Otherwise, problems related to moisture absorption may occur when the part is subjected to high temperature during solder assembly.

The SKY65933-11 is rated to Moisture Sensitivity Level 3 (MSL3) at 260 °C. It can be used for lead or lead-free soldering. For additional information, refer to the Skyworks Application Note, *PCB Design & SMT Assembly/Rework Guidelines for MCM-L Packages*, document number 101752.

Care must be taken when attaching this product, whether it is done manually or in a production solder reflow environment. Production quantities of this product are shipped in a standard tape and reel format.

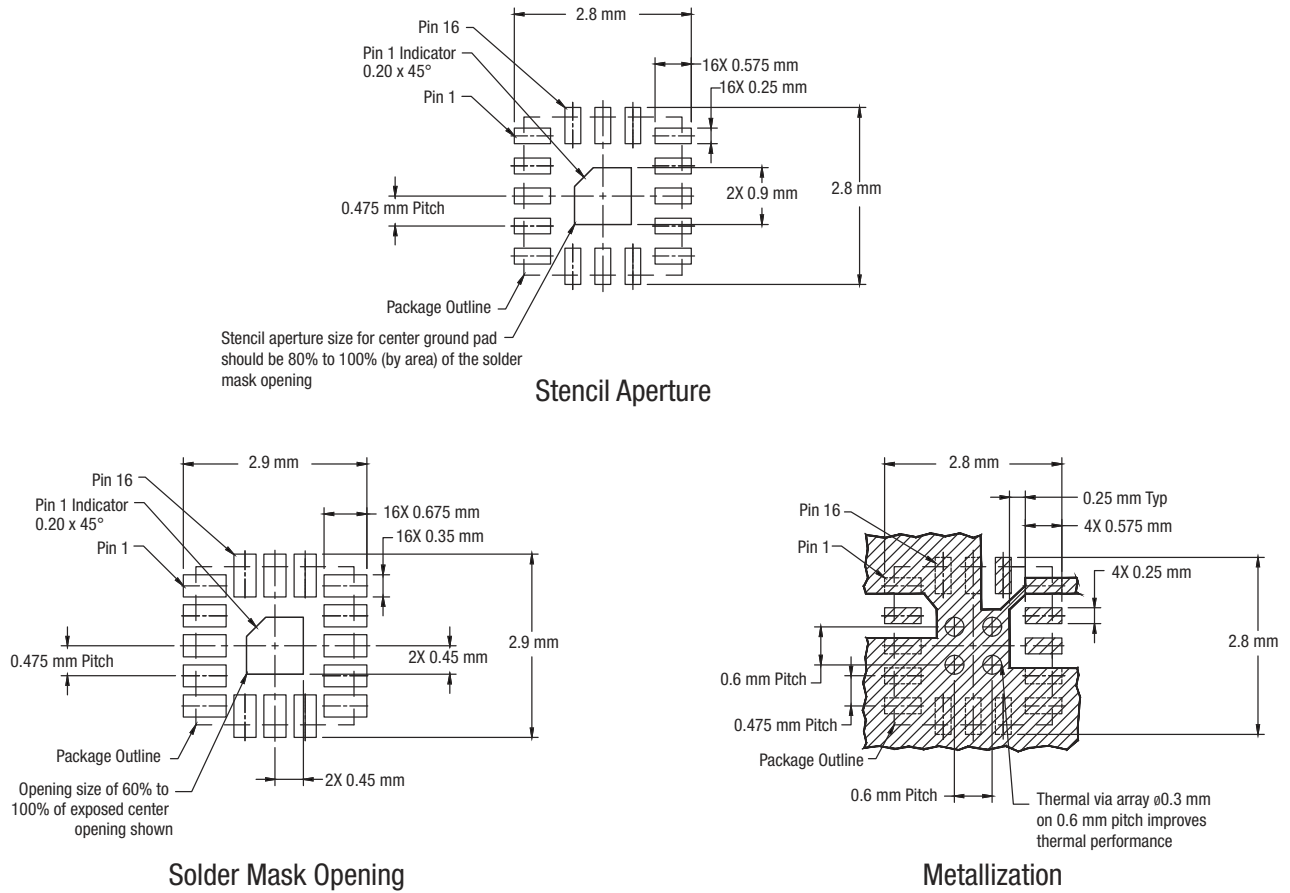

Notes:

1. Thermal vias should be resin filled and capped in accordance with IPC-4761 type VII vias.
2. Recommended Cu thickness is 30 to 35 μm .

204405-005

Figure 5. SKY65933-11 PCB Layout Footprint

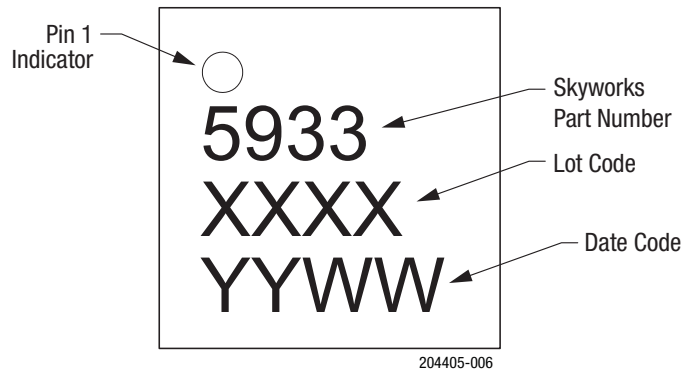

Figure 6. Typical Part Markings (Top View)

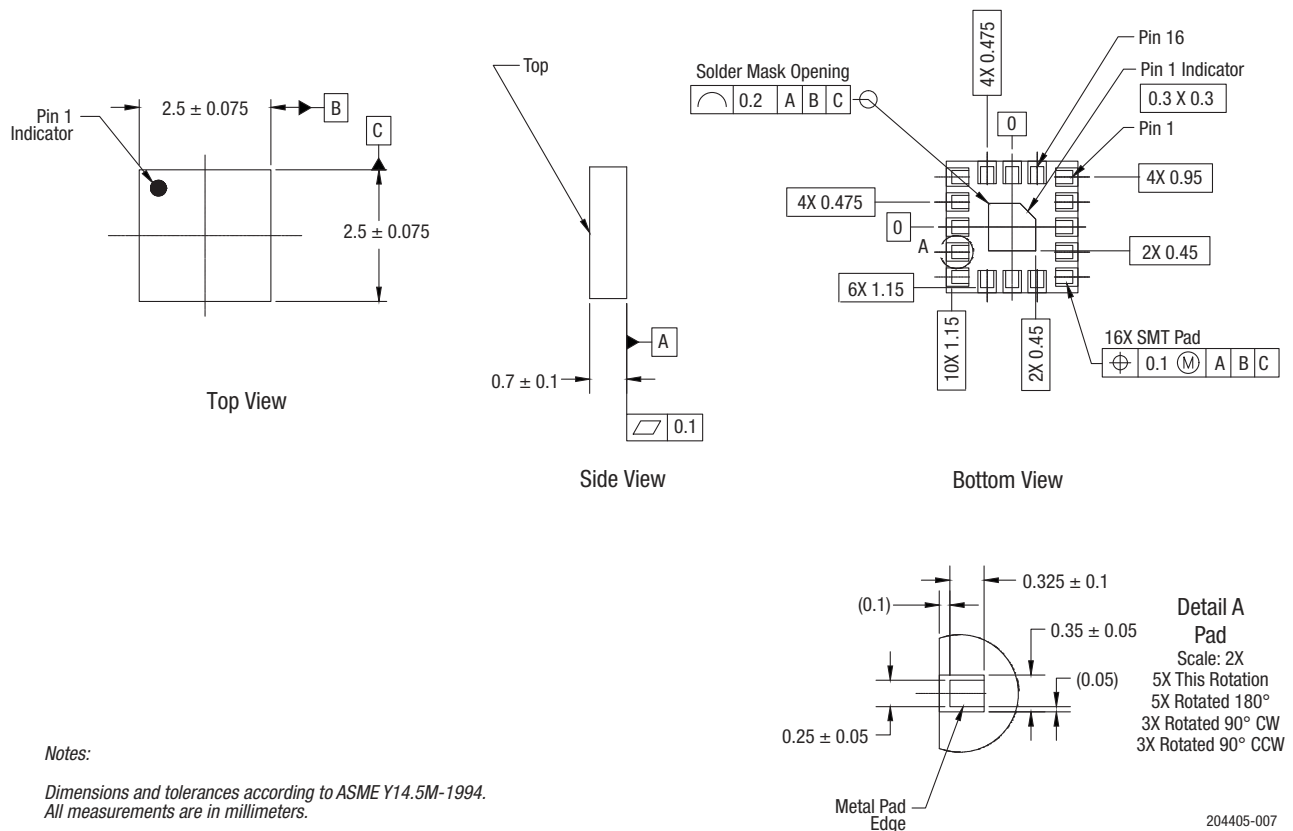

Figure 7. SKY65933-11 Package Dimensions

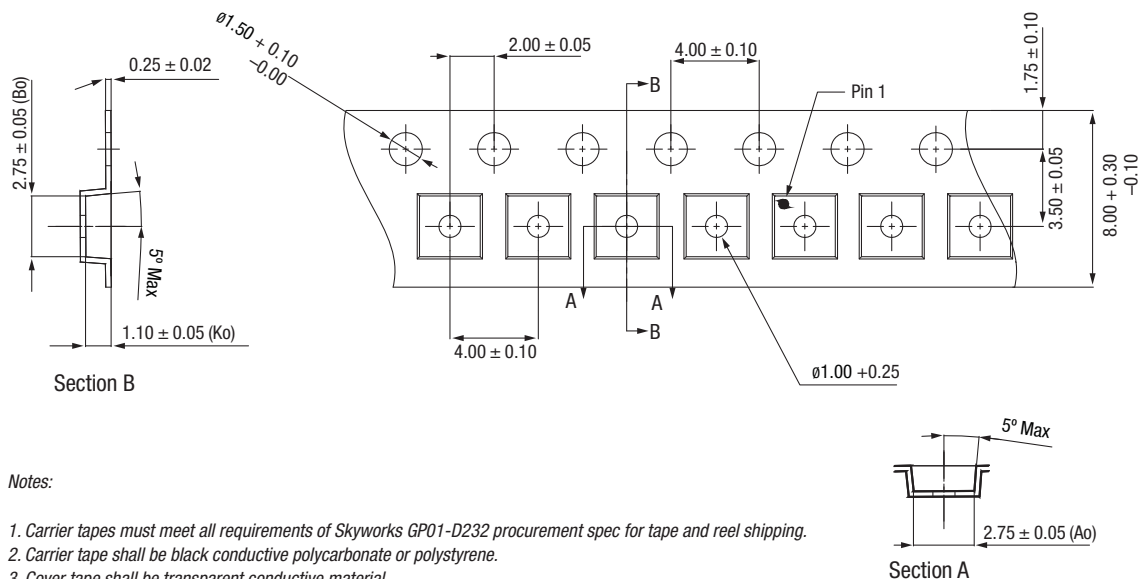

Figure 8. SKY65933-11 Tape and Reel Dimensions

Ordering Information

| Part Number | Product Description | Evaluation Board Part Number |
|-------------|---|------------------------------|
| SKY65933-11 | GNSS Low-Noise Amplifier FEM with Integrated Pre-Filter and Post-Filter | SKY65933-11EK1 |

Copyright © 2016-2018 Skyworks Solutions, Inc. All Rights Reserved.

Information in this document is provided in connection with Skyworks Solutions, Inc. ("Skyworks") products or services. These materials, including the information contained herein, are provided by Skyworks as a service to its customers and may be used for informational purposes only by the customer. Skyworks assumes no responsibility for errors or omissions in these materials or the information contained herein. Skyworks may change its documentation, products, services, specifications or product descriptions at any time, without notice. Skyworks makes no commitment to update the materials or information and shall have no responsibility whatsoever for conflicts, incompatibilities, or other difficulties arising from any future changes.

No license, whether express, implied, by estoppel or otherwise, is granted to any intellectual property rights by this document. Skyworks assumes no liability for any materials, products or information provided hereunder, including the sale, distribution, reproduction or use of Skyworks products, information or materials, except as may be provided in Skyworks Terms and Conditions of Sale.

THE MATERIALS, PRODUCTS AND INFORMATION ARE PROVIDED "AS IS" WITHOUT WARRANTY OF ANY KIND, WHETHER EXPRESS, IMPLIED, STATUTORY, OR OTHERWISE, INCLUDING FITNESS FOR A PARTICULAR PURPOSE OR USE, MERCHANTABILITY, PERFORMANCE, QUALITY OR NON-INFRINGEMENT OF ANY INTELLECTUAL PROPERTY RIGHT; ALL SUCH WARRANTIES ARE HEREBY EXPRESSLY DISCLAIMED. SKYWORKS DOES NOT WARRANT THE ACCURACY OR COMPLETENESS OF THE INFORMATION, TEXT, GRAPHICS OR OTHER ITEMS CONTAINED WITHIN THESE MATERIALS. SKYWORKS SHALL NOT BE LIABLE FOR ANY DAMAGES, INCLUDING BUT NOT LIMITED TO ANY SPECIAL, INDIRECT, INCIDENTAL, STATUTORY, OR CONSEQUENTIAL DAMAGES, INCLUDING WITHOUT LIMITATION, LOST REVENUES OR LOST PROFITS THAT MAY RESULT FROM THE USE OF THE MATERIALS OR INFORMATION, WHETHER OR NOT THE RECIPIENT OF MATERIALS HAS BEEN ADVISED OF THE POSSIBILITY OF SUCH DAMAGE.

Skyworks products are not intended for use in medical, lifesaving or life-sustaining applications, or other equipment in which the failure of the Skyworks products could lead to personal injury, death, physical or environmental damage. Skyworks customers using or selling Skyworks products for use in such applications do so at their own risk and agree to fully indemnify Skyworks for any damages resulting from such improper use or sale.

Customers are responsible for their products and applications using Skyworks products, which may deviate from published specifications as a result of design defects, errors, or operation of products outside of published parameters or design specifications. Customers should include design and operating safeguards to minimize these and other risks. Skyworks assumes no liability for applications assistance, customer product design, or damage to any equipment resulting from the use of Skyworks products outside of stated published specifications or parameters.

Skyworks and the Skyworks symbol are trademarks or registered trademarks of Skyworks Solutions, Inc. or its subsidiaries in the United States and other countries. Third-party brands and names are for identification purposes only, and are the property of their respective owners. Additional information, including relevant terms and conditions, posted at www.skyworksinc.com, are incorporated by reference.

Mouser Electronics

Authorized Distributor

Click to View Pricing, Inventory, Delivery & Lifecycle Information:

[Skyworks:](#)

[SKY65933-11](#)