

**PLEASE CHECK WWW.MOLEX.COM FOR LATEST PART INFORMATION**

**Part Number:** [501331-0807](#)  
**Status:** **Active**  
**Overview:** Pico-Clasp™ Single and Dual Row Wire-to-Board Connectors  
**Description:** 1.00mm Pitch Pico-Clasp™ Wire-to-Board Header, Surface Mount, Single Row, Vertical, with Positive Lock, 8 Circuits, with Cover Tape

**Documents:**

[3D Model](#) [Packaging Specification SPK-501331-001 \(PDF\)](#)  
[Drawing \(PDF\)](#) [RoHS Certificate of Compliance \(PDF\)](#)  
[Product Specification PS-501331-001 \(PDF\)](#)

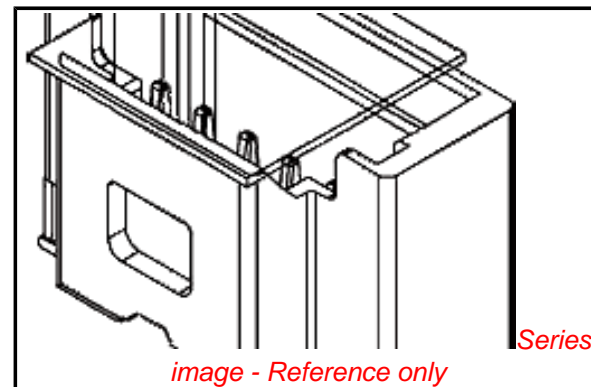

image - Reference only

**General**

Product Family	PCB Headers
Series	501331
Application	Signal, Wire-to-Board
Overview	<u>Pico-Clasp™ Single and Dual Row Wire-to-Board Connectors</u>
Product Name	Pico-Clasp™
UPC	822348542857

**Physical**

Breakaway	No
Circuits (Loaded)	8
Circuits (maximum)	8
Color - Resin	Natural
Durability (mating cycles max)	30
Glow-Wire Compliant	No
Lock to Mating Part	Yes
Material - Metal	Phosphor Bronze
Material - Plating Mating	Tin
Material - Plating Termination	Tin
Material - Resin	Nylon
Net Weight	178.400/mg
Number of Rows	1
Orientation	Vertical
PCB Locator	No
PCB Retention	Yes
Packaging Type	Embossed Tape on Reel
Pitch - Mating Interface	1.00mm
Polarized to Mating Part	Yes
Polarized to PCB	No
Robotic Placement	Vacuum Pick-Up Tape
Stackable	No
Temperature Range - Operating	-40°C to +85°C
Termination Interface: Style	Surface Mount

**Electrical**

Current - Maximum per Contact	1A
Voltage - Maximum	50V AC (RMS)/DC

**Material Info**

**Reference - Drawing Numbers**

Packaging Specification	SPK-501331-001
Product Specification	PS-501331-001, RPS-501331-001, RPS-501331-002, RPS-501331-003, RPS-501331-005, RPS-501331-006,

**EU RoHS**  
**ELV and RoHS**  
**Compliant**  
**REACH SVHC**  
**Contains SVHC: No**  
**Low-Halogen Status**  
**Not Low-Halogen**



**Need more information on product environmental compliance?**

Email [productcompliance@molex.com](mailto:productcompliance@molex.com)  
 For a multiple part number RoHS Certificate of Compliance, [click here](#)

Please visit the [Contact Us](#) section for any non-product compliance questions.

**Search Parts in this Series**

501331Series

**Mates With**

501330 Pico-Clasp™ Wire-to-Board Female Housing

Sales Drawing

RPS-501331-007, RPS-501331-009, RPS-501331-010,  
RPS-501331-012, RPS-501940-001, RPS-501940-002  
SD-501331-002, SD-501331-004

This document was generated on 02/02/2015

**PLEASE CHECK [WWW.MOLEX.COM](http://WWW.MOLEX.COM) FOR LATEST PART INFORMATION**