

**Polar3™ HiPerFET™
Power MOSFET**
**IXFK150N30P3
IXFX150N30P3**

$$V_{DSS} = 300V$$

$$I_{D25} = 150A$$

$$R_{DS(on)} \leq 19m\Omega$$

$$t_{rr} \leq 250ns$$

N-Channel Enhancement Mode
Avalanche Rated
Fast Intrinsic Diode

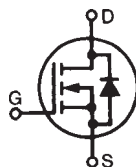

| Symbol | Test Conditions | Maximum Ratings | |
|---------------|--------------------------------------------------------------------|------------------|------------|
| V_{DSS} | $T_J = 25^\circ C$ to $150^\circ C$ | 300 | V |
| V_{DGR} | $T_J = 25^\circ C$ to $150^\circ C$, $R_{GS} = 1M\Omega$ | 300 | V |
| V_{GSS} | Continuous | ± 20 | V |
| V_{GSM} | Transient | ± 30 | V |
| I_{D25} | $T_C = 25^\circ C$ | 150 | A |
| I_{DM} | $T_C = 25^\circ C$, Pulse Width Limited by T_{JM} | 375 | A |
| I_A | $T_C = 25^\circ C$ | 75 | A |
| E_{AS} | $T_C = 25^\circ C$ | 4 | J |
| P_D | $T_C = 25^\circ C$ | 1300 | W |
| dv/dt | $I_S \leq I_{DM}$, $V_{DD} \leq V_{DSS}$, $T_J \leq 150^\circ C$ | 35 | V/ns |
| T_J | | -55 ... +150 | $^\circ C$ |
| T_{JM} | | 150 | $^\circ C$ |
| T_{stg} | | -55 ... +150 | $^\circ C$ |
| T_L | Maximum Lead Temperature for Soldering | 300 | $^\circ C$ |
| T_{SOLD} | 1.6 mm (0.062in.) from Case for 10s | 260 | $^\circ C$ |
| M_d | Mounting Torque (TO-264) | 1.13/10 | Nm/lb.in |
| F_C | Mounting Force (PLUS247) | 20..120 /4.5..27 | N/lb |
| Weight | TO-264 | 10 | g |
| | PLUS247 | 6 | g |

TO-264 (IXFK)

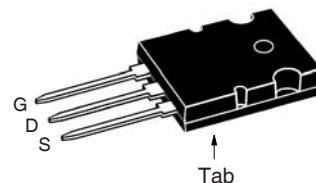

PLUS247 (IXFX)

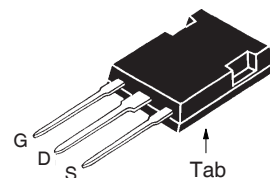

G = Gate D = Drain
S = Source Tab = Drain

Features

- Dynamic dv/dt Rating
- Avalanche Rated
- Fast Intrinsic Diode
- Low Q_G
- Low $R_{DS(on)}$
- Low Drain-to-Tab Capacitance
- Low Package Inductance

Advantages

- Easy to Mount
- Space Savings

Applications

- DC-DC Converters
- Battery Chargers
- Switch-Mode and Resonant-Mode Power Supplies
- Uninterrupted Power Supplies
- AC Motor Drives
- High Speed Power Switching Applications

| Symbol | Test Conditions ($T_J = 25^\circ C$ Unless Otherwise Specified) | Characteristic Values | | |
|--------------|---------------------------------------------------------------------|-----------------------|------|--------------------|
| | | Min. | Typ. | Max. |
| BV_{DSS} | $V_{GS} = 0V$, $I_D = 3mA$ | 300 | | V |
| $V_{GS(th)}$ | $V_{DS} = V_{GS}$, $I_D = 8mA$ | 3.0 | | 5.0 V |
| I_{GSS} | $V_{GS} = \pm 20V$, $V_{DS} = 0V$ | | | ± 200 nA |
| I_{DSS} | $V_{DS} = V_{DSS}$, $V_{GS} = 0V$ $T_J = 125^\circ C$ | | | 25 μA 1 mA |
| $R_{DS(on)}$ | $V_{GS} = 10V$, $I_D = 0.5 \cdot I_{D25}$, Note 1 | | | 19 m Ω |

| Symbol | Test Conditions ($T_J = 25^\circ\text{C}$ Unless Otherwise Specified) | Characteristic Values | | |
|--------------|----------------------------------------------------------------------------------------------------------------------------------------------|-----------------------|-------|--------------------|
| | | Min. | Typ. | Max. |
| g_{fs} | $V_{DS} = 10\text{V}, I_D = 60\text{A}$, Note 1 | 65 | 110 | S |
| C_{iss} | $V_{GS} = 0\text{V}, V_{DS} = 25\text{V}, f = 1\text{MHz}$ | | 12.1 | nF |
| C_{oss} | | | 1910 | pF |
| C_{rss} | | | 40 | pF |
| R_{Gi} | Gate Input Resistance | | 1.0 | Ω |
| $t_{d(on)}$ | Resistive Switching Times $V_{GS} = 10\text{V}, V_{DS} = 0.5 \cdot V_{DSS}, I_D = 0.5 \cdot I_{D25}$ $R_G = 1\Omega$ (External) | | 44 | ns |
| t_r | | | 30 | ns |
| $t_{d(off)}$ | | | 74 | ns |
| t_f | | | 12 | ns |
| $Q_{g(on)}$ | $V_{GS} = 10\text{V}, V_{DS} = 0.5 \cdot V_{DSS}, I_D = 0.5 \cdot I_{D25}$ | | 197 | nC |
| Q_{gs} | | | 70 | nC |
| Q_{gd} | | | 65 | nC |
| R_{thJC} | | | 0.096 | $^\circ\text{C/W}$ |
| R_{thCS} | | 0.15 | | $^\circ\text{C/W}$ |

Source-Drain Diode

| Symbol | Test Conditions ($T_J = 25^\circ\text{C}$, Unless Otherwise Specified) | Characteristic Values | | |
|----------|-----------------------------------------------------------------------------|-----------------------|------|--------|
| | | Min. | Typ. | Max. |
| I_S | $V_{GS} = 0\text{V}$ | | | 150 A |
| I_{SM} | Repetitive, Pulse Width Limited by T_{JM} | | | 600 A |
| V_{SD} | $I_F = 100\text{A}, V_{GS} = 0\text{V}$, Note 1 | | | 1.5 V |
| t_{rr} | $I_F = 75\text{A}, -di/dt = 100\text{A}/\mu\text{s}$ | | | 250 ns |
| Q_{RM} | | | 2.9 | |
| I_{RM} | $V_R = 100\text{V}, V_{GS} = 0\text{V}$ | | 23.0 | A |

Note 1. Pulse test, $t \leq 300\mu\text{s}$, duty cycle, $d \leq 2\%$.

PRELIMINARY TECHNICAL INFORMATION

The product presented herein is under development. The Technical Specifications offered are derived from a subjective evaluation of the design, based upon prior knowledge and experience, and constitute a "considered reflection" of the anticipated result. IXYS reserves the right to change limits, test conditions, and dimensions without notice.

IXYS Reserves the Right to Change Limits, Test Conditions, and Dimensions.

IXYS MOSFETs and IGBTs are covered 4,835,592 4,931,844 5,049,961 5,237,481 6,162,665 6,404,065 B1 6,683,344 6,727,585 7,005,734 B2 7,157,338B2
by one or more of the following U.S. patents: 4,860,072 5,017,508 5,063,307 5,381,025 6,259,123 B1 6,534,343 6,710,405 B2 6,759,692 7,063,975 B2
4,881,106 5,034,796 5,187,117 5,486,715 6,306,728 B1 6,583,505 6,710,463 6,771,478 B2 7,071,537

TO-264 AA Outline

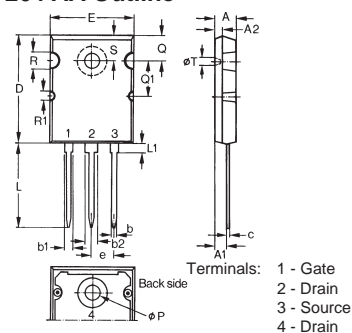

| Dim. | Millimeter | | Inches | |
|------|------------|-------|----------|-------|
| | Min. | Max. | Min. | Max. |
| A | 4.82 | 5.13 | .190 | .202 |
| A1 | 2.54 | 2.89 | .100 | .114 |
| A2 | 2.00 | 2.10 | .079 | .083 |
| b | 1.12 | 1.42 | .044 | .056 |
| b1 | 2.39 | 2.69 | .094 | .106 |
| b2 | 2.90 | 3.09 | .114 | .122 |
| c | 0.53 | 0.83 | .021 | .033 |
| D | 25.91 | 26.16 | 1.020 | 1.030 |
| E | 19.81 | 19.96 | .780 | .786 |
| e | 5.46 BSC | | .215 BSC | |
| J | 0.00 | 0.25 | .000 | .010 |
| K | 0.00 | 0.25 | .000 | .010 |
| L | 20.32 | 20.83 | .800 | .820 |
| L1 | 2.29 | 2.59 | .090 | .102 |
| P | 3.17 | 3.66 | .125 | .144 |
| Q | 6.07 | 6.27 | .239 | .247 |
| Q1 | 8.38 | 8.69 | .330 | .342 |
| R | 3.81 | 4.32 | .150 | .170 |
| R1 | 1.78 | 2.29 | .070 | .090 |
| S | 6.04 | 6.30 | .238 | .248 |
| T | 1.57 | 1.83 | .062 | .072 |

PLUS247™ Outline

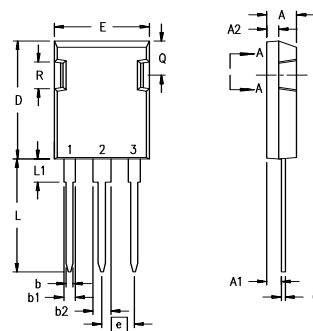

Terminals: 1 - Gate
2 - Drain
3 - Source

| Dim. | Millimeter | | Inches | |
|------|------------|-------|----------|-------|
| | Min. | Max. | Min. | Max. |
| A | 4.83 | 5.21 | .190 | .205 |
| A1 | 2.29 | 2.54 | .090 | .100 |
| A2 | 1.91 | 2.16 | .075 | .085 |
| b | 1.14 | 1.40 | .045 | .055 |
| b1 | 1.91 | 2.13 | .075 | .084 |
| b2 | 2.92 | 3.12 | .115 | .123 |
| C | 0.61 | 0.80 | .024 | .031 |
| D | 20.80 | 21.34 | .819 | .840 |
| E | 15.75 | 16.13 | .620 | .635 |
| e | 5.45 BSC | | .215 BSC | |
| L | 19.81 | 20.32 | .780 | .800 |
| L1 | 3.81 | 4.32 | .150 | .170 |
| Q | 5.59 | 6.20 | .220 | 0.244 |
| R | 4.32 | 4.83 | .170 | .190 |

Fig. 1. Output Characteristics @ $T_J = 25^\circ\text{C}$

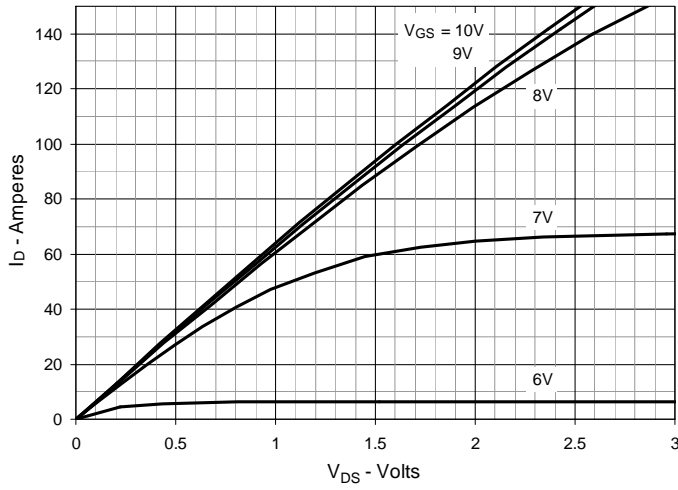

Fig. 2. Extended Output Characteristics @ $T_J = 25^\circ\text{C}$

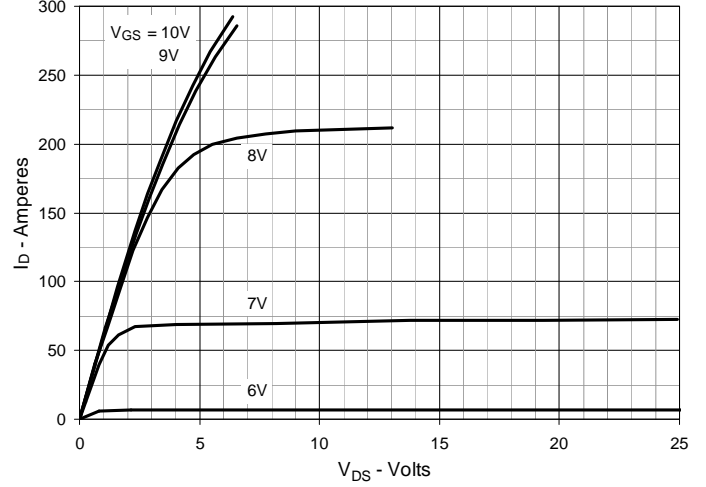

Fig. 3. Output Characteristics @ $T_J = 125^\circ\text{C}$

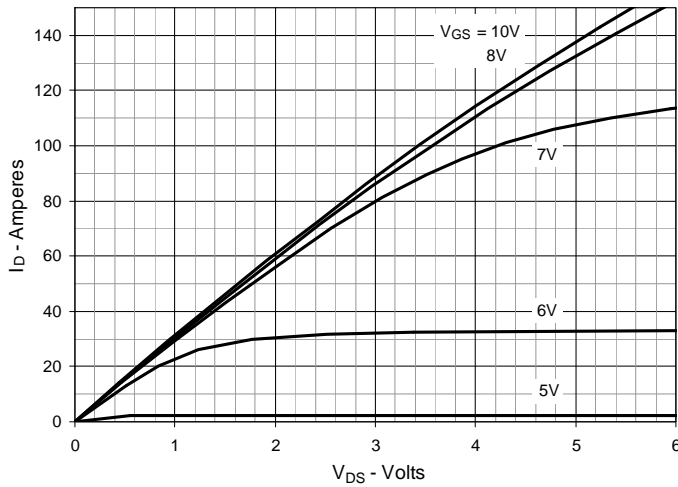

Fig. 4. $R_{DS(on)}$ Normalized to $I_D = 75A$ Value vs. Junction Temperature

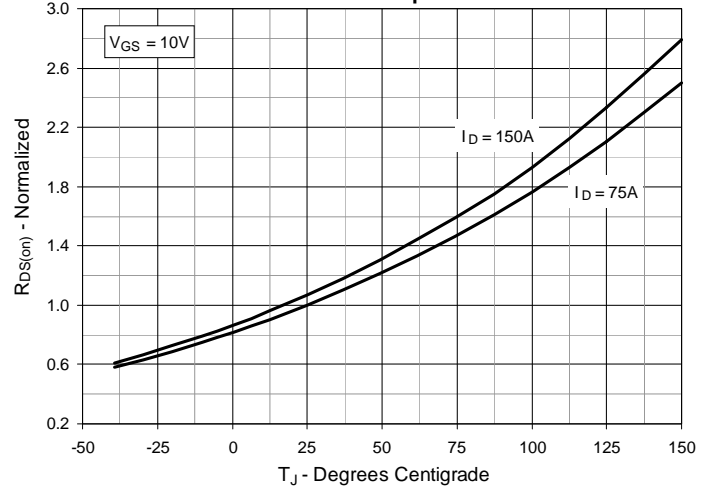

Fig. 5. $R_{DS(on)}$ Normalized to $I_D = 75A$ Value vs. Drain Current

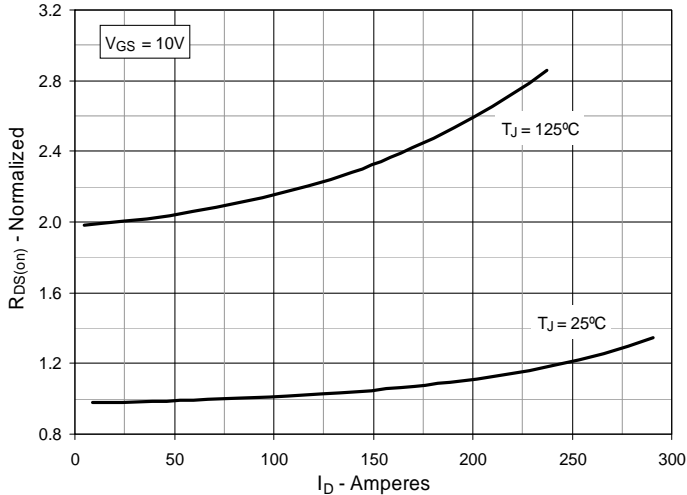

Fig. 6. Maximum Drain Current vs. Case Temperature

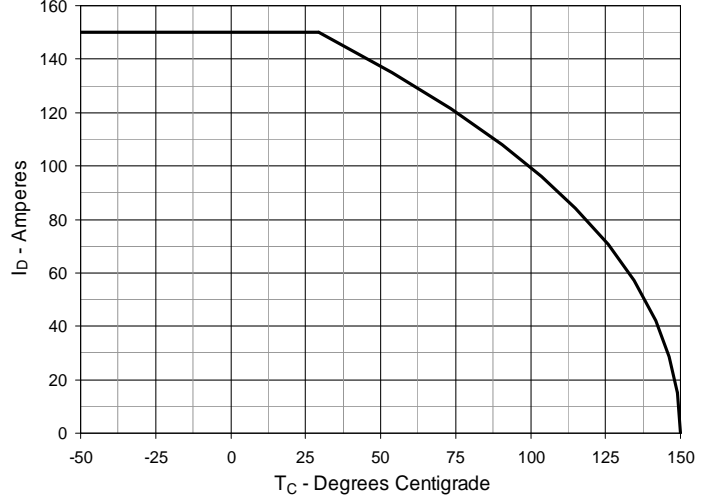

Fig. 7. Input Admittance

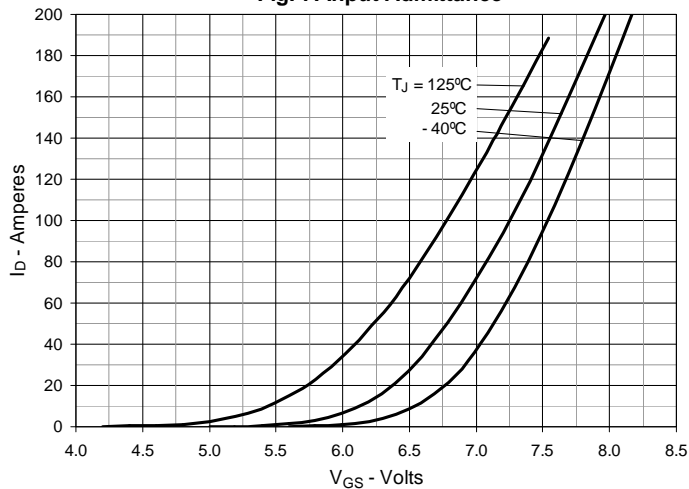

Fig. 8. Transconductance

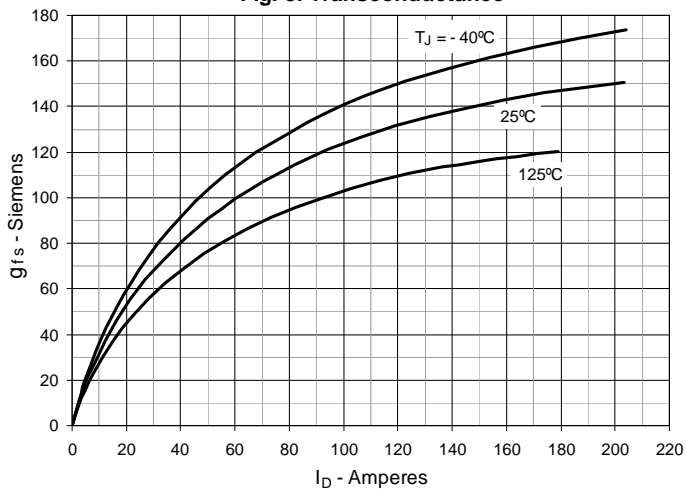

Fig. 9. Forward Voltage Drop of Intrinsic Diode

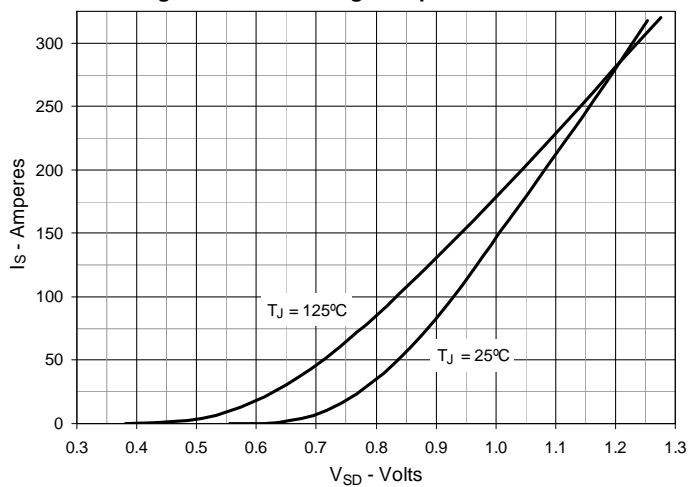

Fig. 10. Gate Charge

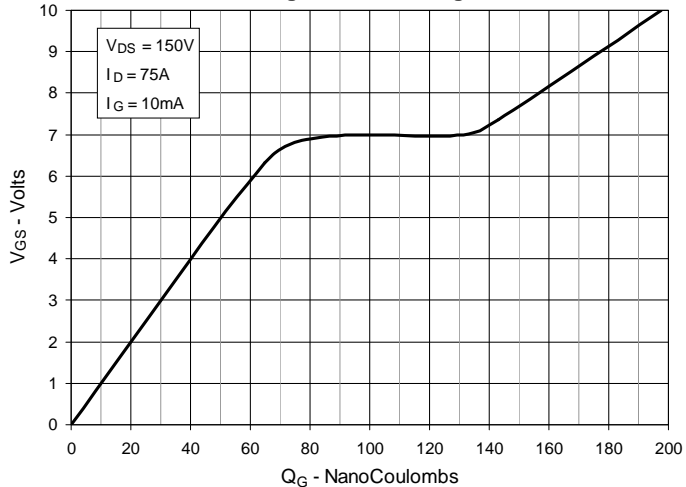

Fig. 11. Capacitance

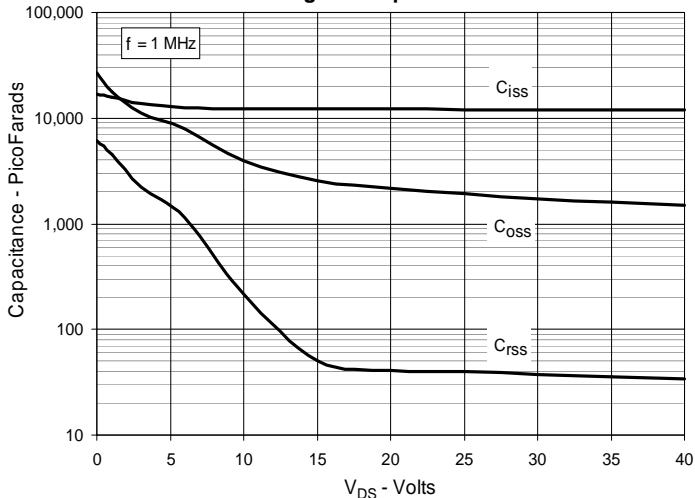

Fig. 12. Forward-Bias Safe Operating Area

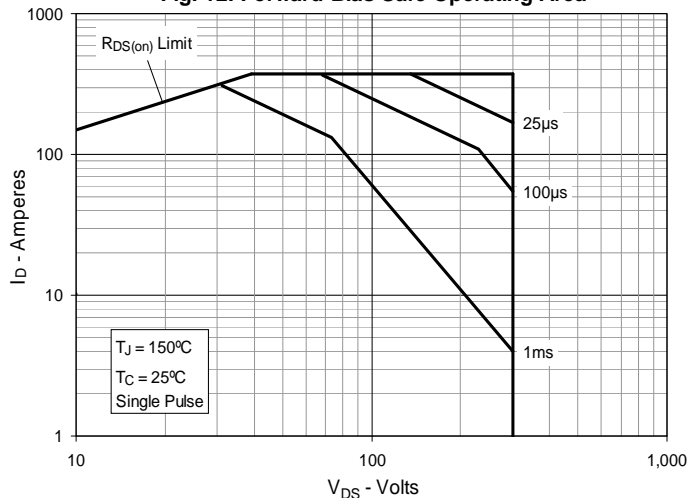

Fig. 13. Maximum Transient Thermal Impedance

