

For more than two decades, ceramic filter technology has been instrumental in the proliferation of solid state electronics. A view of the future reveals that even greater expectations will be placed on piezoelectric material in the area of new applications and for more stringent performance criteria in current products. Traditionally, nearly all low and high-end AM and FM commercial radios use ceramic band-pass filters. However, applications are also found in cordless telephones, cellular systems, 2-way communications, and the television industry.

As a world leader in the development of piezo ceramic filter technology, Murata Electronics had been able to develop specialized ceramic materials which when combined with an advance filter design have resulted in a complete line of practical, inexpensive ceramic filters for entertainment and communications applications. In this catalog, the principle of ceramic filters, the design of representative test circuits

and specifications concerning various models are described.

PIEZOELECTRIC THEORY AS APPLIED TO CERAMIC FILTERS

All ceramic filters derive their basic frequency selectivity from a mechanical vibration resulting from a piezoelectric effect. While a total theoretical analysis of piezoelectric technology as applied to ceramic filters is very complex, it can be shown as the equivalent circuit as illustrated in Fig. 430-1. This equivalent circuit represents a typical two-terminal filter, a device which forms the basic building block for more complex filters.

The resonant frequency of this device is calculated by the equation:

$$f_r = \frac{1}{2\pi \sqrt{L_1 C_1}}$$

The anti-resonant frequency is expressed as:

$$f_a = \frac{1}{2\pi \sqrt{L_1 \frac{C_1 C_0}{C_1 + C_0}}}$$

This filter exhibits the impedance shown in Fig. 430-2.

Two-terminal filters are typically used as emitter bypasses and they exhibit the frequency characteristics shown in Fig. 430-3.

Three-terminal ceramic filters can be used as inter-stage coupling devices as shown in Fig. 430-4. By using our filters in this manner, increased selectivity, improved band pass characteristics, reliability and stability can be obtained without increasing circuit complexity or parts count.

By cascading two or more filters as shown in Figs. 431-5 and 6, Murata can greatly enhance selectivity. By controlling the coefficient of electromechanical coupling between the filter elements, bandwidth can be "peaked" or "flattened." Typical 455kHz response curves are shown in Figs. 431-7 and 8.

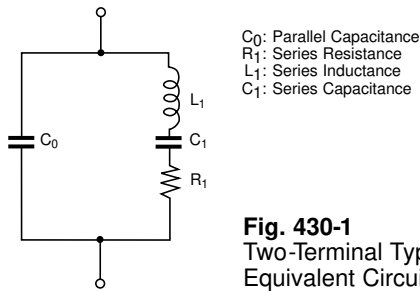

Fig. 430-1
Two-Terminal Type
Equivalent Circuit

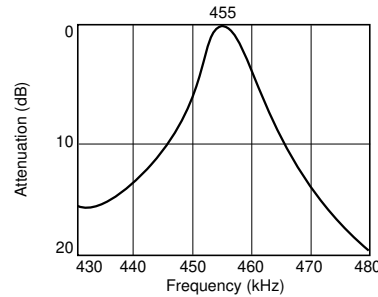

Fig. 430-3
Typical Attenuation Characteristics
For A 455kHz (Two-Terminal)
Ceramic Filter

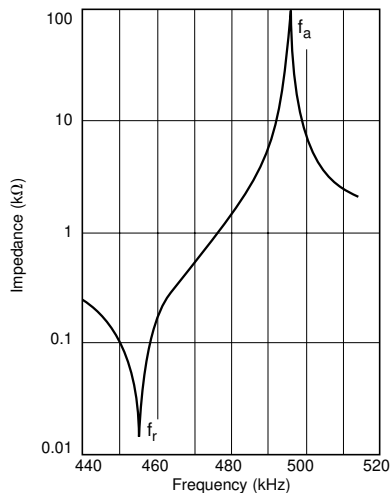

Fig. 430-2
Typical Impedance vs
Frequency Response Curve For
A Two-Terminal Device

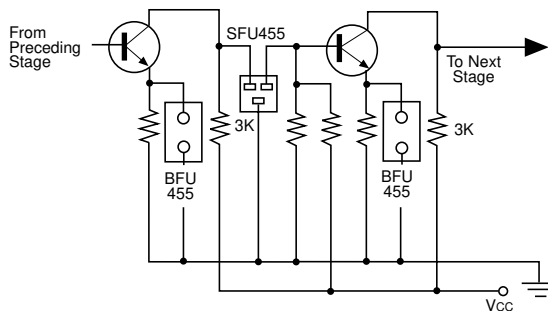

Fig. 430-4
Three-Terminal
Filter Used As Inter-Stage
Coupling Device

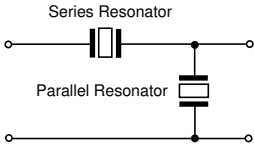

Fig. 431-5
Ladder Connection

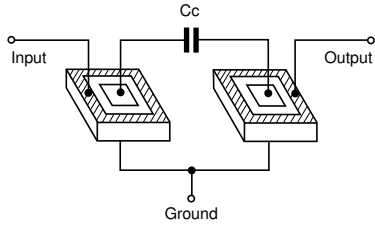

Fig. 431-6
Cascade Connection

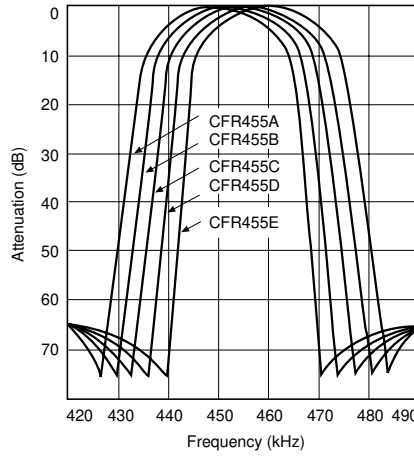

Fig. 431-7
Typical Response Curves For
CFR455 A-E Series Ceramic Filters

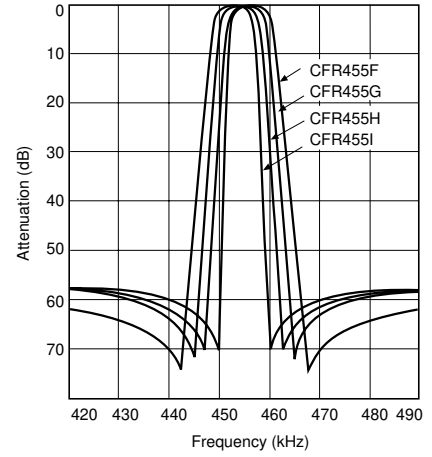

Fig. 431-8
Typical Response Curves For
CFR455 F-I Series Ceramic Filters

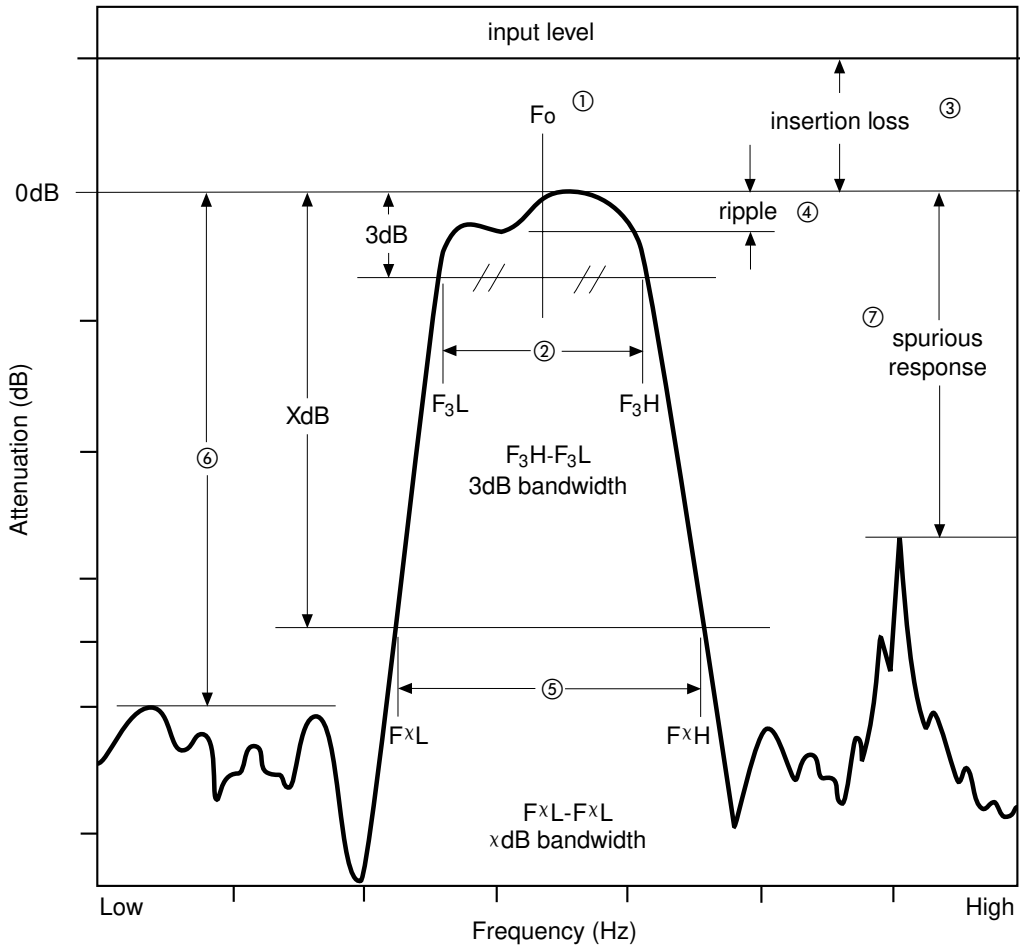

Fig. 431-9
Graphical Representation of Ceramic Filter Terminology

CERAMIC FILTER TERMINOLOGY

Although the previous section has presented a concise discussion of piezoelectric theory as applied to ceramic filter technology, it is necessary that the respective terminology used in conjunction with ceramic filters be discussed before any further examination of ceramic filter technology is made.

Using Fig.431-9 as a typical model of a response curve for a ceramic filter, it can be seen that there are a number of relevant factors to be considered in specifying ceramic filters. These include: center frequency, pass-bandwidth,

insertion loss, ripple, attenuation bandwidth, stopband attenuation, spurious response and selectivity. Although not all of these factors will apply to each filter design, these are the key specifications to consider with most filters. From the symbol key shown in Table 432-1 below, a thorough understanding of this basic terminology should be possible.

IMPEDANCE MATCHING

As it is imperative to properly match the impedances whenever any circuit is connected to another circuit, any component to another component, or any circuit to another component, it is also important that this be taken into account in using ceramic filters.

Without proper impedance matching, the operational characteristics of the ceramic filters cannot be met.

Fig. 433-12 illustrates a typical example of this requirement.

This example shows the changes produced in the frequency characteristics of the SFZ455A ceramic filter when the resistance values are altered. For instance, if the input/output impedances R_1 and R_2 are connected to lower values than those specified, the insertion loss increases, the center frequency shifts toward the low side and the ripple increases.

TABLE 432-1 – CERAMIC FILTER TERMINOLOGY CHART

Numbers In Fig. 431-9	Terminology	Symbol	Unit	Explanation of Term
1	Center Frequency	f_0	Hz	The frequency in the center of the pass-bandwidth. However, the center frequency for some products is expressed as the point where the loss is at its lowest point.
2	Pass-bandwidth (3dB Bandwidth)	(3dB) B.W.	Hz	Signifies a difference between the two frequencies where the attenuation becomes 3dB from the level of the minimum loss point.
3	Insertion Loss	I.L.	dB	Expressed as the input/output ratio at the point of minimum loss. (The insertion loss for some products is expressed as the input/output ratio at the center frequency.) Insertion loss = $20 \text{ LOG } (V_2/V_1)$ in dB.
4	Ripple	—	dB	If there are peaks and valleys in the pass-bandwidth, the ripple expresses the difference between the maximum peak and the minimum valley.
5	Attenuation Bandwidth (dB Bandwidth)	20 (dB) (B.W.)	Hz	The bandwidth at a specified level of attenuation. Attenuation may be expressed as the ratio of the input signal strength to the output signal strength in decibels.
6	Stopband Attenuation	—	dB	The level of signal strength at a specified frequency outside of the passband.
7	Spurious Response	SR	dB	The difference in decibels between the insertion loss and the spurious signal in the stopband.
	Input/Output Impedance	—	Ohm	Internal impedance value of the input and output of the ceramic filter
	Selectivity	—	dB	The ability of a filter to pass signals of one frequency and reject all others. A highly selective filter has an abrupt transition between a passband region and the stopband region. This is expressed as the shape factor—the attenuation bandwidth divided by the pass - bandwidth. The filter becomes more selective as the resultant value approaches one.

On the other hand, if R_1 and R_2 are connected to higher values other than those specified, the insertion loss will increase, the center frequency will shift toward the high side and the ripple will increase.

DEALING WITH SPURIOUS RESPONSE

Frequently in using 455kHz filters, spurious will cause problems due to the fact that the resonance occurs under an alien vibrating mode or overtone deviating from the basic vibration characteristics. Among available solutions for dealing with spurious response are:

1. The use of a supplementary IFT together with the ceramic filter for suppression of the spurious.
2. The arrangement of two or more ceramic filters in parallel for the mutual cancellation of spurious.
3. The addition of a low-pass or high-pass LC filter for suppression of spurious. Perhaps the most commonly used method of dealing

with spurious is the use of a supplementary IFT in conjunction with the ceramic filter. The before and after effects of the use of an IFT are shown in Figs. 433-10 and 11. In Fig. 433-10, only a single SFZ455A ceramic filter is employed and spurious is a significant problem. With the addition of an IFT, the spurious problem is reduced as is shown in Fig. 433-11.

Although spurious is a significant problem to contend with when using 455kHz ceramic filters, it is not a problem in 4.5MHz and 10.7MHz ceramic filters, as their vibration modes are significantly different.

CONSIDERATIONS FOR GAIN DISTRIBUTION

Since the impedance of both the input and output values of the ceramic filters are symmetric and small, it is necessary that the overall gain distribution within the circuit itself be taken into consideration. For instance, in the discussion concerning proper impedance matching, it was illustrated

that a certain DC loss occurs if the recommended resistance values are not used. This can cause an overall reduction in the gain which could present a problem if no allowances have been made for the corresponding loss. To compensate for this problem, it is recommended that the following be done:

1. The amplifier stage should be designed to compensate for this loss.
2. The ceramic filter should be used in combination with the IFT for minimizing both matching and DC losses. The IFT should be used strictly as a matching transformer and the ceramic filter only for selectivity.

As the use of IC's has become more prevalent with ceramic filters, these considerations have been taken into account. It should be noted that few of the problems discussed above have been realized when more than three (3) IF stages have been employed.

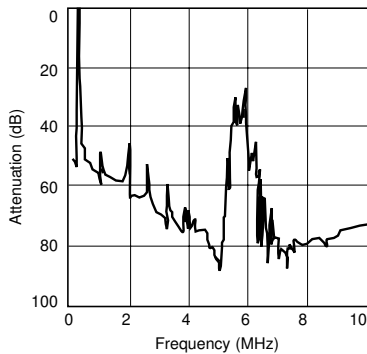

Fig. 433-10
Spurious Response With Model SFZ455A Ceramic Filter

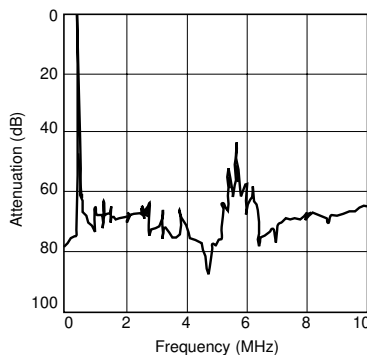

Fig. 433-11
Spurious Response With Model SFZ455A Ceramic Filter And IFT

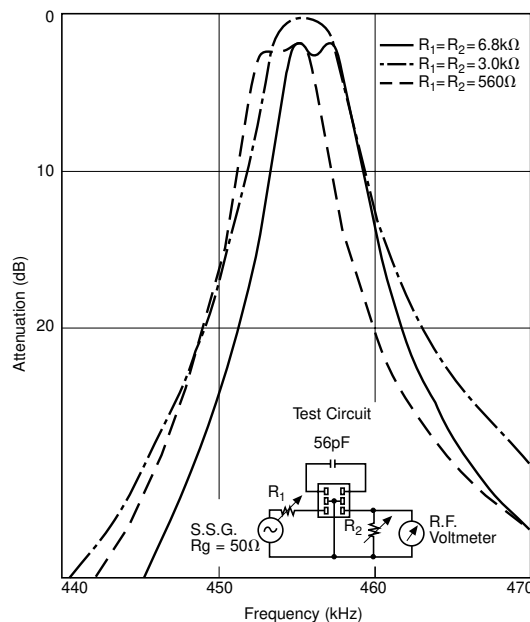

Fig. 433-12
Model SFZ455A Ceramic Filter Matching Impedance vs. Pass-Band Characteristics

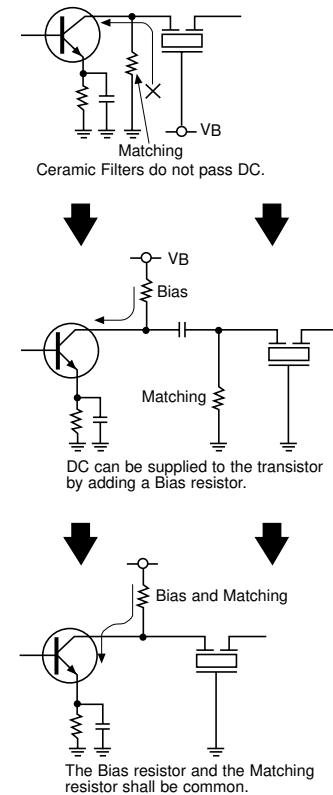

Fig. 433-13
Coupling With A Transistor

CERAMIC FILTERS DO NOT PASS DC

It is important to note in designing circuits that ceramic filters are incapable of passing DC. As is illustrated in Fig. 433-13, in a typical circuit where a transistor is used, a bias circuit will be required to drive the transistor. Since the ceramic filter requires matching resistance to operate properly, the matching resistor shown in the diagram can play a dual role as both a matching and bias resistor.

If the bias circuit is used, it is important that the parallel circuit of both the bias resistance and the transistor's internal resistance be taken into consideration in meeting the resistance values.

This is necessary since the internal resistance of the transistor is changed by the bias resistance. However, when an IC is used, there is no need for an additional bias circuit since the IC has a bias circuit within itself.

Here it is recommended that an IFT be used for impedance matching with the ceramic filter when coupling with a mixer stage, as shown in Fig. 434-14.

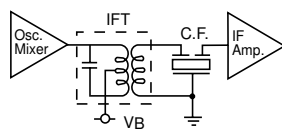

Fig. 434-14
Coupling From Mixer Stage

COUPLING CAPACITANCE

The SFZ455A is composed of two filter elements which must be connected by a coupling capacitor. Moreover, the frequency characteristic changes according to the coupling capacitance (C_c). As shown in Fig. 434-15, the larger the coupling capacitance (C_c) becomes, the wider the bandwidth and more the ripple increases. Conversely, the smaller the coupling capacitance becomes, the narrower the bandwidth becomes and the more the insertion loss increases. Therefore, the specified value of the coupling capacitance in the catalog is desired in determining the specified passband characteristics.

GROUP DELAY TIME CHARACTERISTICS

Perhaps one of the most important characteristics of a transmitting element is to transmit a signal with the lowest possible distortion level. This distortion occurs when the phase shift of a signal which passes through a certain transmitting path is non-linear with respect to the frequency. For convenience, the group delay time (GDT) characteristic is used for the purpose of expressing non-linearity.

It is important to note the relationship between the amplitude and the GDT characteristics when using group delay time terminology. This relationship differs depending upon the filter characteristics. For example, in the Butterworth type, which has a relatively flat top, the passband is flat while the GDT characteristic is extremely curved, as shown in Fig. 434-16. On the other hand, a Gaussian type, is curved in the passband, while the GDT characteristic is flat. With the flat GDT characteristics, the Gaussian type has excellent distortion characteristics.

Since the amplitude characteristics for the Butterworth type is flat in the passband the bandwidth does not change even at a low input level. With the amplitude characteristic for the Gaussian type being curved in the passband, the bandwidth becomes narrow at a low input level and the sensitivity is poor. Therefore, it should be noted that the Gaussian type has a desirable distortion factor while the Butterworth type has the desirable sensitivity.

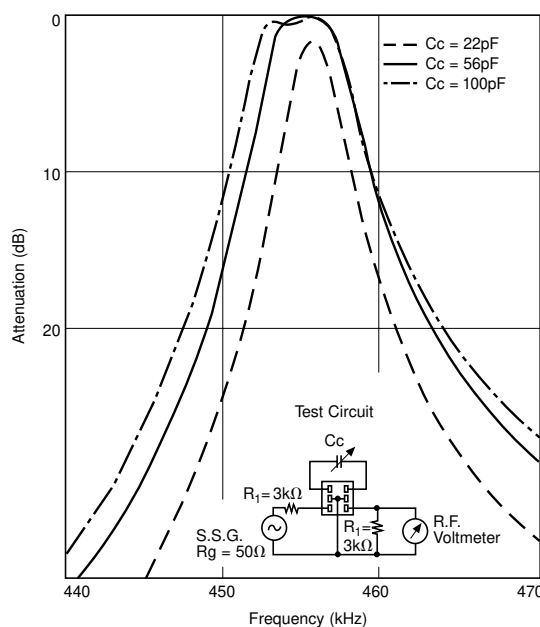
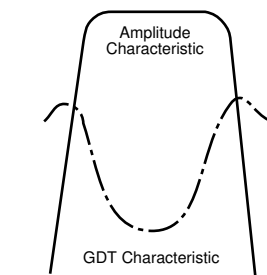
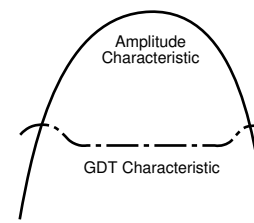

Fig. 434-15
Model SFZ455A Ceramic Filter
Coupling Capacitance vs. Passband
Characteristics



(A) Butterworth Characteristic



(B) Gaussian Characteristic

Fig. 434-16
Relationship Between Amplitude
And GDT Characteristics

PIEZO FILTERS MULTI-ELEMENT FILTERS, RESIN MOLDED, HIGHLY SELECTIVE

CFWS 455kHz



The CFWS 455 line of ceramic filters are 6-element devices connected in ladder form. These compact, highly selective filters are recommended for use in applications ranging from two-way radio to auxiliary filters in high class transceivers. (Also available in 450kHz version.)

SPECIFICATIONS

CFWS 455kHz

Part Number	Nominal Center Frequency (kHz)	6dB Bandwidth (kHz) min.	40dB Bandwidth (kHz) max.	Attenuation 455±100kHz (dB) min.	Ripple (dB) max. kHz	Insertion Loss (dB) max.	Input/Output Impedance (Ohms)
★CFWS455B	455	±15	±30	35	3 (455 ± 10)	4	1500
★CFWS455C	455	±12.5	±24	35	3 (455 ± 8)	4	1500
★CFWS455D	455	±10	±20	35	3 (455 ± 7)	4	1500
★CFWS455E	455	±7.5	±15	35	3 (455 ± 5.0)	6	1500
★CFWS455F	455	±6	±12.5	35	3 (455 ± 4)	6	2000
★CFWS455G	455	±4.5	±10	35	2 (455 ± 3)	6	2000
CFWS455HT	455	±3	±9	60	2 (455 ± 2)	6	2000
CFWS455IT	455	±2	±7.5	60	2 (455 ± 1.5)	6	2000

DIMENSIONS: mm

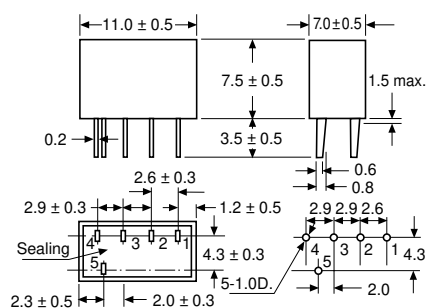

CIRCUIT

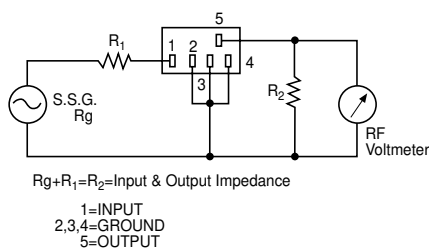

CHARACTERISTICS

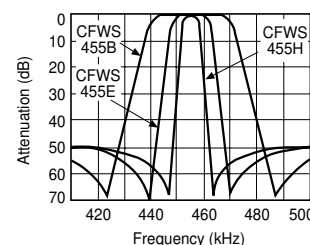

★ Available as standard through authorized Murata Electronics Distributors.

*Note: For safety purposes, connect the output of filters to the IF amplifier through a DC blocking capacitor. Avoid applying a direct current to the output of ceramic filters.

CFUM/CFWM 455kHz



The CFUM 455 and CFWM 455 lines of ceramic filters are miniaturized versions of the CFU/CFWS lines. These ultra-miniature versions consume approximately 40% less volume while still offering the same high performance filter characteristics available with the CFU/CFWS lines. (Also available in 450kHz version.)

SPECIFICATIONS

CFUM 455kHz

Part Number	Nominal Center Frequency (kHz)	6dB Bandwidth (kHz) min.	40dB Bandwidth (kHz) max.	Attenuation 455±100kHz (dB) min.	Insertion Loss (dB) max.	Input/Output Impedance (Ohms)
★CFUM455B	455	±15	±30	27	4	1500
★CFUM455C	455	±12.5	±24	27	4	1500
★CFUM455D	455	±10	±20	27	4	1500
★CFUM455E	455	±7.5	±15	27	6	1500
★CFUM455F	455	±6	±12.5	27	6	2000
★CFUM455G	455	±4.5	±10	25	6	2000
★CFUM455H	455	±3	±9	35	6	2000
★CFUM455I	455	±2	±7.5	35	7	2000

DIMENSIONS: mm

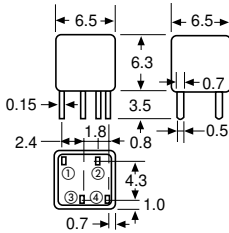

CIRCUIT

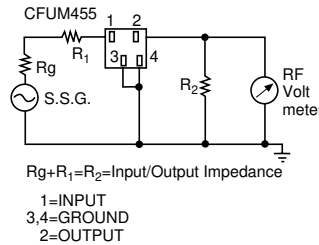

CHARACTERISTICS

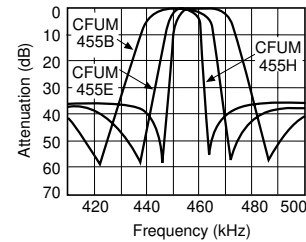

SPECIFICATIONS

CFWM 455kHz

Part Number	Nominal Center Frequency (kHz)	6dB Bandwidth (kHz) min.	40dB Bandwidth (kHz) max.	Attenuation 455±100kHz (dB) min.	Insertion Loss (dB) max.	Input/Output Impedance (Ohms)
★CFWM455B	455	±15	±30	35	4	1500
★CFWM455C	455	±12.5	±24	35	4	1500
★CFWM455D	455	±10	±20	35	4	1500
★CFWM455E	455	±7.5	±15	35	6	1500
★CFWM455F	455	±6	±12.5	35	6	2000
★CFWM455G	455	±4.5	±10	35	6	2000
★CFWM455H	455	±3	±9	55	6	2000
★CFWM455I	455	±2	±7.5	55	7	2000

• CFWM455□ series filters are 6-element ceramic filters and ultraminiature versions of CFWS455□ series.

DIMENSIONS: mm

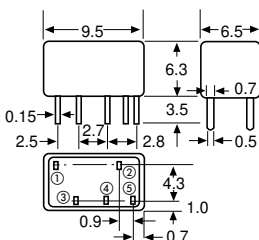

CIRCUIT

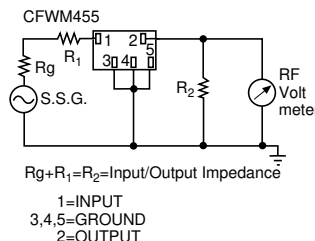

CHARACTERISTICS

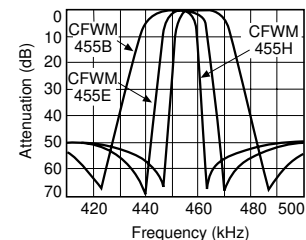

*Available as standard through authorized Murata Electronics Distributors.

*Note: For safety purposes, connect the output of filters to the IF amplifier through a DC blocking capacitor. Avoid applying a direct current to the output of ceramic filters.

PIEZO FILTERS

MULTI-ELEMENT, ULTRA-MINIATURE, RESIN MOLDED, HIGHLY SELECTIVE

CFVM/CFZM 455kHz



The CFVM 455 line of ceramic filters are 7-element devices connected in ladder form while the CFZM 455 line of filters contain 9-elements. These highly selective filters offer improved stopband attenuation and are recommended for use in a variety of applications. (Also available in 450kHz version.)

SPECIFICATIONS

CFVM 455kHz

Part Number	Nominal Center Frequency (kHz)	3dB Bandwidth (kHz) min.	6dB Bandwidth (kHz) min.	Ripple (dB) max.	60dB Bandwidth (kHz) max.	Attenuation (dB) min.	Spurious Response (dB) min.	Insertion Loss (dB) max.	Input/Output Impedance (Ohms)
CFVM455B	455	±10	±15	3	±25	50	25	4	1000
CFVM455C	455	±9	±13	3	±23	50	25	4	1000
CFVM455D	455	±7	±10	3	±20	50	25	4	1500
CFVM455E	455	±5.5	±8	3	±16	50	25	6	1500
CFVM455E10	455	±5.0	±7.0	3	±12.5	50	25	6	1500
CFVM455F	455	±4.2	±6	3	±12	50	25	6	1500
CFVM455G	455	—	±4	3	±10	50	25	6	1500
CFVM455H	455	—	±3	3	±7.5	50	25	6	1500

DIMENSIONS: mm

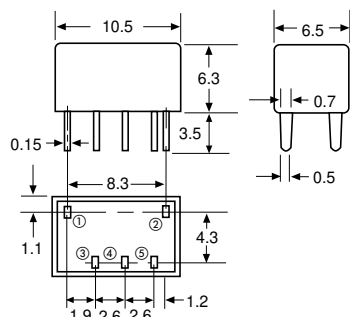

CIRCUIT

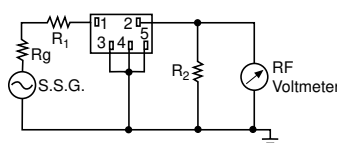

$R_g + R_1 = \text{Input/Output Impedance}$

1=INPUT
3,4,5=GROUND
2=OUTPUT

CHARACTERISTICS

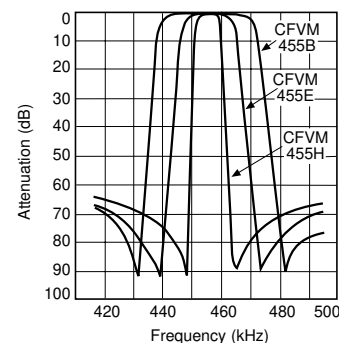

SPECIFICATIONS

CFZM 455kHz

Part Number	Nominal Center Frequency (kHz)	3dB Bandwidth (kHz) min.	6dB Bandwidth (kHz) min.	Ripple (dB) max.	70dB Bandwidth (kHz) max.	Attenuation (dB) min.	Spurious Response (dB) min.	Insertion Loss (dB) max.	Input/Output Impedance (Ohms)
CFZM455B	455	±10	±15	3	±25	70	40	4	1000
CFZM455C	455	±9	±13	3	±23	70	40	4	1000
CFZM455D	455	±7	±10	3	±20	70	40	4	1500
CFZM455E	455	±5.5	±8	3	±16	70	40	6	1500
CFZM455E10	455	±5.0	±7.5	3	±12.5	70	40	6	1500
CFZM455F	455	±4.2	±6	3	±12	70	50	6	1500
CFZM455G	455	—	±4	3	±10	70	50	6	1500
CFZM455H	455	—	±3	3	±7.5	70	50	7	1500

DIMENSIONS: mm

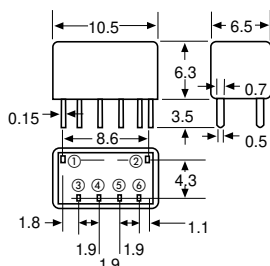

CIRCUIT

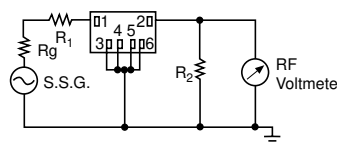

$R_g + R_1 = R_2 = \text{Input/Output Impedance}$

1=INPUT
3,4,5,6=GROUND
2=OUTPUT

CHARACTERISTICS

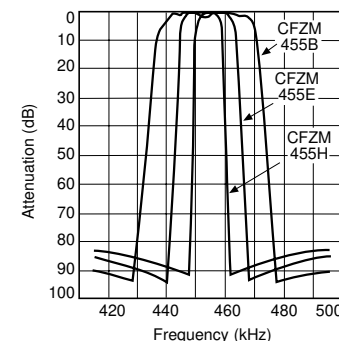

*Note: For safety purposes, connect the output of filters to the IF amplifier through a DC blocking capacitor. Avoid applying a direct current to the output of ceramic filters.

PIEZO FILTERS MULTI-ELEMENT HIGH PERFORMANCE



CFM/CFJ/CFR/CFS/CFL 455kHz

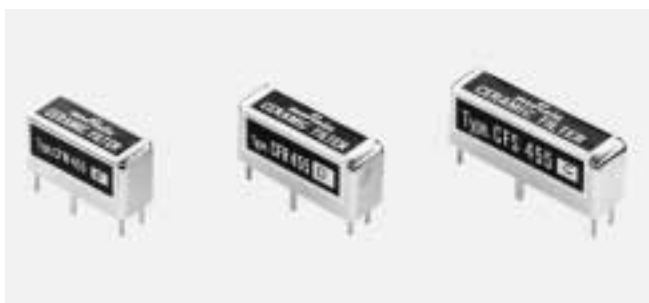

The following lines of filters are high performance devices that achieve ultimate stopband attenuation through the use of multiple piezoelectric elements connected in ladder form. A few of the recommended applications for these filters include high class receivers, SSB communications equipment, pocket pagers and mobile radios.

- CFM 455 9 Ceramic Elements**
- CFJ 455K 11 Ceramic Elements**
- CFR 455 11 Elements Filters**
- CFS 455 15 Element Filters**
- CFL 455 9 Element Filters (GDT Improved)**

(NOT available in 450kHz.)

SPECIFICATIONS

CFM/CFJ/CFR/CFS/CFL 455kHz

Part Number	Nominal Center Frequency (kHz)	3dB Bandwidth (kHz) min.	6dB Bandwidth (kHz) min.	Ripple (dB) max.	Bandwidth		Attenuation 455±100kHz (dB) min.	Spurious 0.1 ~ 1MHz (dB) min.	Insertion Loss (dB) max.	Input/Output Impedance (Ohms)	Group Delay Time Dev. sec. max. (kHz)
					(kHz) max.	At (dB)					
CFM455A	455	±13	±17.5	3	±30	60	50	30	3	1000	
CFM455B	455	±10	±15	3	±25		50	30	3	1000	
CFM455C	455	±9	±13	3	±23		50	30	3	1000	
CFM455D	455	±7	±10	3	±20		50	30	3	1500	
CFM455E	455	±5.5	±8	3	±16		45	30	5	1500	
CFM455F	455	±4.2	±6	3	±12		45	30	6	2000	
CFM455G	455	—	±4	3	±10		45	30	6	2000	
CFM455H	455	—	±3	3	±7.5		45	30	6	2000	
CFM455I	455	—	±2	3	±5		45	30	7	2000	
CFR455A	455	±13	±17.5	3	±30		70	60	40	4	1000
CFR455B	455	±10	±15	3	±25	60		40	4	1000	
CFR455C	455	±9	±13	3	±23	60		40	4	1000	
CFR455D	455	±7	±10	3	±20	60		40	4	1500	
CFR455E	455	±5.5	±8	3	±16	55		40	6	1500	
CFR455F	455	±4.2	±6	3	±12	55		40	6	2000	
CFR455G	455	—	±4	3	±10	55		40	6	2000	
CFR455H	455	—	±3	3	±7.5	55		40	7	2000	
CFR455I	455	—	±2	3	±5	55		40	8	2000	
CFR455J	455	—	±1.5	3	±4.5	55		40	8	2000	
CFJ455K5	455	—	2.4 (Total)	2	4.5 (Total)	60	—	60 ^{40 at 600 ~ 700kHz}	6	2000	
CFJ455K14	455	—	±1.1 ~ ±1.3	2	4.5 (Total)		—	60 ^{40 at 600 ~ 700kHz}	7	2000	
CFJ455K8	455	—	1.0 (Total)	1.5	3.0 (Total)		60	—	8	2000	
CFS455A	455	±13	±17.5	3	±30	80	70	50	4	1500	
CFS455B	455	±10	±15	3	±25		70	50	4	1500	
CFS455C	455	±9	±13	3	±23		70	50	4	1500	
CFS455D	455	±7	±10	3	±20		70	50	4	1500	
CFS455E	455	±5.5	±8	3	±15		70	50	6	1500	
CFS455F	455	±4.2	±6	3	±12		70	50	6	2000	
CFS455G	455	—	±4	3	±9		70	50	6	2000	
CFS455H	455	—	±3	3	±7.5		70	50	7	2000	
CFS455I	455	—	±2	3	±5		70	50	8	2000	
CFS455J	455	—	±1.5	3	±4.5		60	50	8	2000	
CFL455BG5	455	±10.5	±13.5	0.5	±27.5	60	60	30	10	1000	25μ(455±10.5)
CFL455CG1	455	±9.5	±12.0	0.5	±25.5		60	30	10	1000	35μ(455±9.5)
CFL455DG2	455	±7.0	±9.0	0.5	±21.0		60	30	11	1000	35μ(455±7)
CFL455EG1	455	±5.0	±7.0	0.5	±18		60	30	13	1500	30μ(455±5)

DIMENSIONS: mm

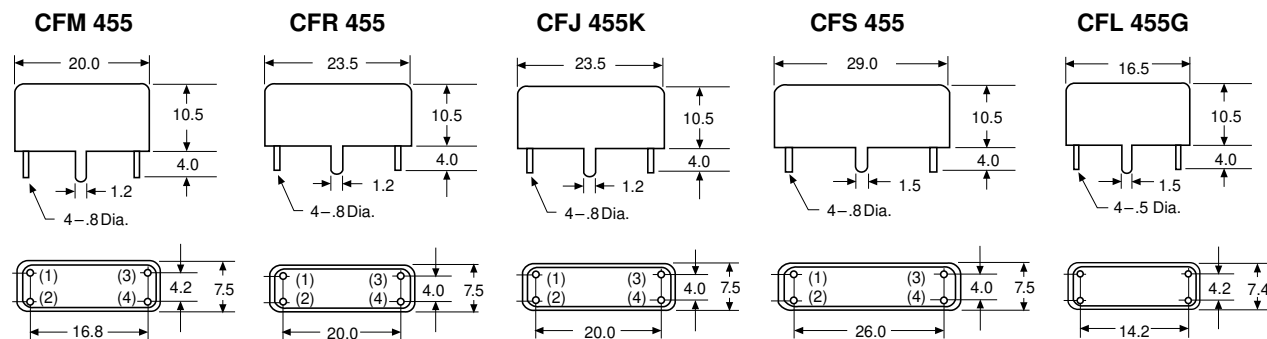

*Note: For safety purposes, connect the output of filters to the IF amplifier through a DC blocking capacitor. Avoid applying a direct current to the output of ceramic filters.

PIEZO FILTERS

MULTI-ELEMENT, RESIN MOLDED, G.D.T. FLAT TYPE

CFWS□Y 455kHz



The CFWS□Y lines of ceramic filters are 6-element devices connected in ladder form. These highly selective filters are designed to address the G.D.T. characteristics required in digital communications. The excellent G.D.T. characteristics allow these filters to be utilized in areas such as the mobile cellular markets as well as a variety of stereo applications. (Also available in 450kHz version.)

SPECIFICATIONS

CFWS□Y 455kHz

Part Number	6dB Bandwidth (kHz) min.	50dB Bandwidth (kHz) min.	Insertion Loss (dB) max.	Attenuation at 455 ± 100kHz (dB) min.	Group Delay Time sec. max. (kHz)	Input/Output Impedance (Ohms)
CFWS455BY	±15.0	±35	6.0	35	30μ (455 ± 10)	1.5k
CFWS455CY	±12.5	±30	7.0	35	30μ (455 ± 8.0)	1.5k
CFWS455DY	±10.0	±25	8.0	35	30μ (455 ± 7.0)	1.5k
CFWS455EY	±7.5	±20	9.0	35	30μ (455 ± 5.0)	1.5k
CFWS455FY	±6.0	±17.5	10.0	35	40μ (455 ± 4.0)	2.0k
CFWS455GY	±4.5	±15	13.0	35	40μ (455 ± 3.0)	2.0k

DIMENSIONS: mm

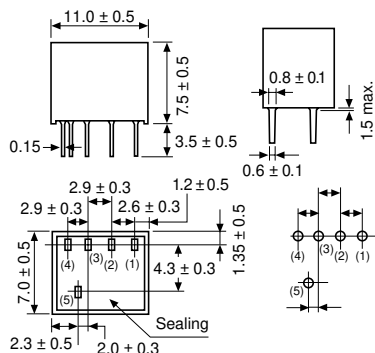

CIRCUIT

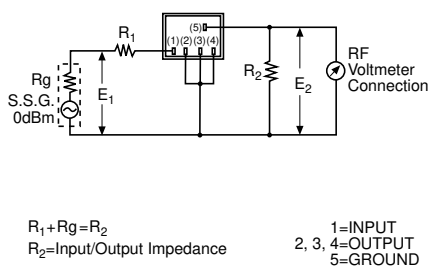

TYPICAL CHARACTERISTICS

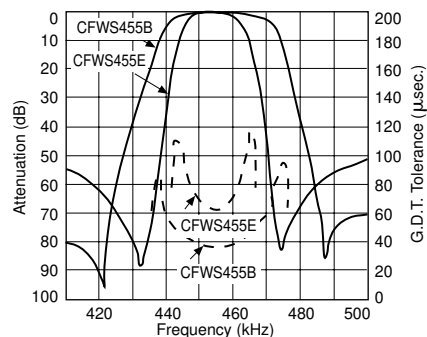

PIEZO FILTERS MULTI-ELEMENT, ULTRA MINIATURE G.D.T. FLAT TYPE

CFUM□Y/CFWM□Y 455kHz



The CFUM□Y/CFWM□Y lines of ceramic filters are miniaturized versions of the CFUS□Y/CFWS□Y lines. These ultra-miniature versions consume approximately 40% less volume while still offering the same excellent G.D.T. characteristics as the CFUS□Y/CFWS□Y lines. This reduction in size makes these devices ideal for compact communication applications such as mobile telephones. (Also available in 450kHz version.)

SPECIFICATIONS

CFUM□Y 455kHz

Part Number	6dB Bandwidth (kHz) min.	40dB Bandwidth (kHz) max.	Attenuation at 455 ± 100kHz (dB) min.	Insertion Loss (dB) max.	Group Delay Time sec. max. (kHz)	Input/Output Impedance (Ohms)
CFUM455BY	±15	±35	23	5	15μ (455 ± 10.0)	1500
CFUM455CY	±12.5	±30	23	6	15μ (455 ± 8.0)	1500
CFUM455DY	±10	±25	23	7	20μ (455 ± 7.0)	1500
CFUM455EY	±7.5	±20	23	8	20μ (455 ± 5.0)	1500
CFUM455FY	±6.0	±17.5	23	9	20μ (455 ± 4.0)	2000
CFUM455GY	±4.5	±15	23	10	20μ (455 ± 3.0)	2000

- CFUM455□Y is a miniaturized 4-element version of the conventional CFUS455□Y.
- Note: For safety purposes, connect the output of filters to the IF amplifier through a DC blocking capacitor. Avoid applying a direct current to the output of ceramic filters.

DIMENSIONS: mm

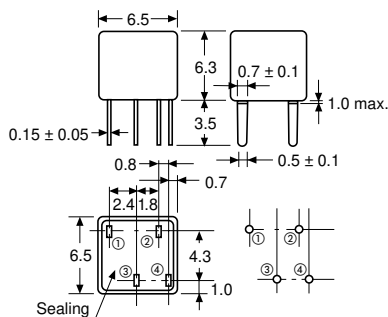

CIRCUIT

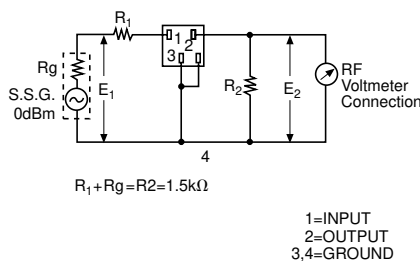

CHARACTERISTICS

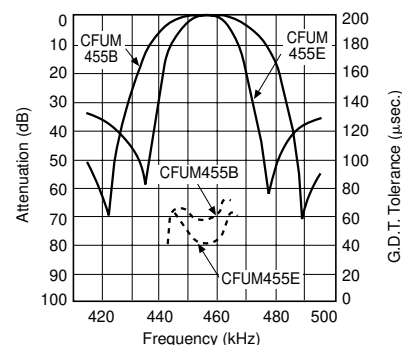

SPECIFICATIONS

CFWM□Y 455kHz

Part Number	6dB Bandwidth (kHz) min.	50dB Bandwidth (kHz) max.	Attenuation at 455 ± 100kHz (dB) min.	Insertion Loss (dB) max.	Group Delay Time sec. max. (kHz)	Input/Output Impedance (Ohms)
CFWM455BY	±15	±35	35	6	30μ (455 ± 10.0)	1500
CFWM455CY	±12.5	±30	35	7	30μ (455 ± 8.0)	1500
CFWM455DY	±10	±25	35	8	30μ (455 ± 7.0)	1500
CFWM455EY	±7.5	±20	35	9	30μ (455 ± 5.0)	1500
CFWM455FY	±6.0	±17.5	35	10	40μ (455 ± 4.0)	2000
CFWM455GY	±4.5	±15	35	13	40μ (455 ± 3.0)	2000

- CFWM455□Y is a miniaturized 4-element version of the conventional CFWS455□Y.
- Note: For safety purposes, connect the output of filters to the IF amplifier through a DC blocking capacitor. Avoid applying a direct current to the output of ceramic filters.

DIMENSIONS: mm

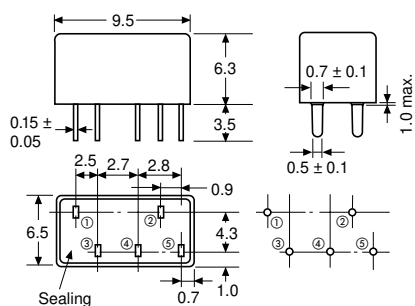

CIRCUIT

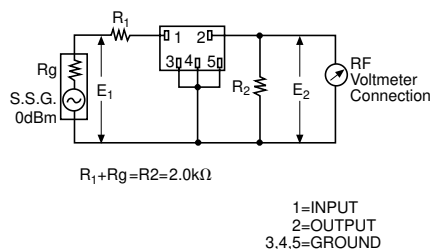

CHARACTERISTICS

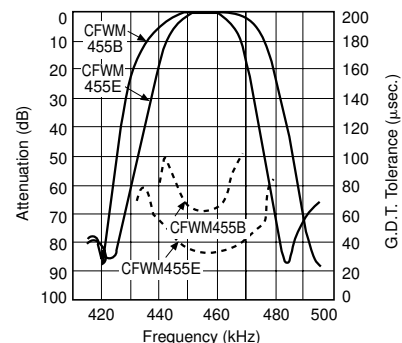

PIEZO FILTERS

SURFACE MOUNTED CHIP PIEZOELECTRIC CERAMICS FILTERS FOR MOBILE COMMUNICATIONS APPLICATIONS

NEW

muRata
Innovator in Electronics

CFUXC 450kHz



Introducing Murata's newest surface mount kHz filter, the CFUXC Series. This is a 4-element filter that uses new technology developed by Murata to achieve the world's smallest and lightest surface mount kHz filter. This 2mm high filter offers the attenuation of a 6-element filter and a good G.D.T. in a smaller package.

SPECIFICATIONS

CFUXC 450kHz

Part Number	Nominal Center Frequency (kHz)	3dB Bandwidth (kHz min.)	6dB Bandwidth (kHz min.)	50dB Bandwidth (kHz min.)	Spurious Response Attenuation (dB min.)	Insertion Loss (dB max.)	Ripple (dB max.)	G.D.T. Deviation (μsec. max.)	Input/Output Impedance (Ohms)
CFUXC450A100H-TC01	450	—	±17.5	±55	40	5	0.5	15	2k
CFUXC450B100H-TC01	450	—	±15	±50	40	6	0.5	15	2k
CFUXC450C100H-TC01	450	±9 ~ ±12	—	±35	40	6	0.5	27	2k

DIMENSIONS: mm

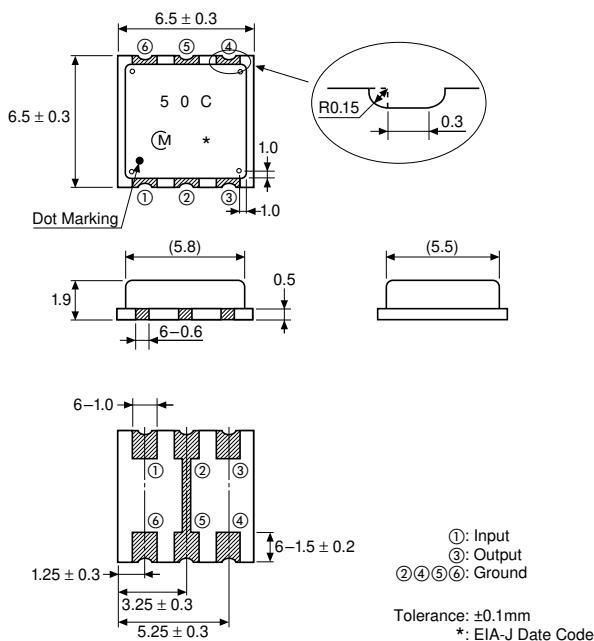

TEST CIRCUIT

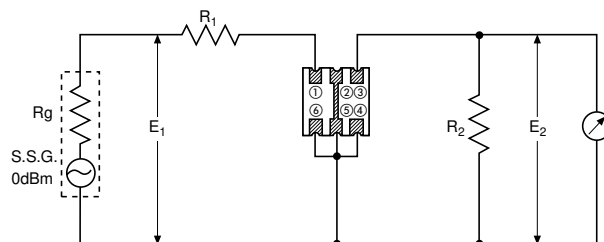

$$R_1 + R_g = R_2 = 2.0k\Omega$$

$$\text{Insertion Loss (dB)} = 20 \cdot \log \left(\frac{E_1}{E_2} \right) - 6 \text{ (dB)}$$

$$= 20 \cdot \log E_1 - 20 \cdot \log E_2 - 6 \text{ (dB)}$$

E_1 : S.S.G. high impedance output

TAPING DIMENSIONS: mm

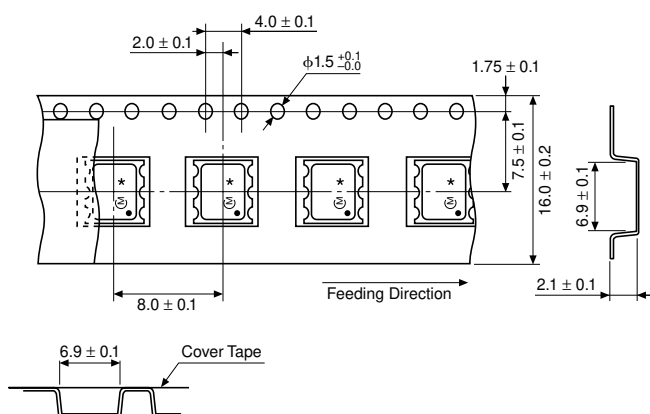

REEL DIMENSIONS: mm

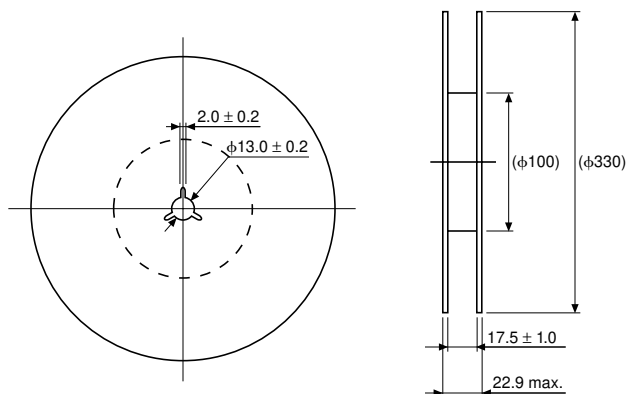

*Note: For safety purposes, connect the output of filters to the IF amplifier through a DC blocking capacitor. Avoid applying a direct current to the output of ceramic filters.

PIEZO FILTERS

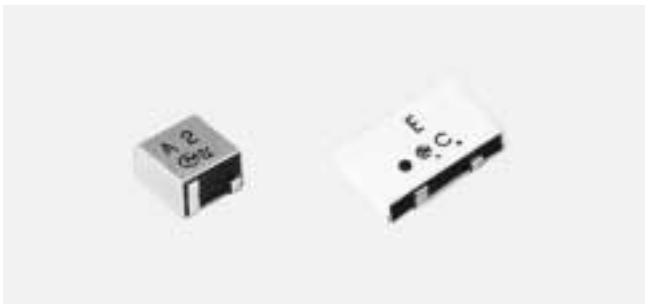

Along with the development of the AM chip filter, IF filters for AM radios have also been made smaller, thinner and in a chip configuration for surface mounting. This is one more example of Murata Electronics' leadership in converting conventional electronic components to chip technology.

PRELIMINARY SPECIFICATIONS

SMD 455kHz

Part Number	Center Frequency		Bandwidth (Total)			Ripple (max.)		*Insertion Loss (max.) dB	Stop Band Atten. (min.) at ± 100 kHz dB	Group Delay (max.)		Source And Load Impedance (Ohms)
	Nom. (kHz)	Tol. \pm (kHz)	3dB (min.) (kHz)	6dB (min.) (kHz)	40dB (max.) (kHz)	dB	Point of Measure			μ S	Point of Measure	
CFUCG455E-TC	455	1.5	—	15	30	1.5	—	6	27	—	—	1500
CFUCG455F-TC	455	1.5	—	12	25	1.5	—	6	27	—	—	1500
CFUCG455G-TC	455	1	—	9	20	1.5	—	6	25	—	—	1500
CFUCG455FX-TC	455	1.5	—	12	30	1	—	6	27	25	—	1500
CFUCG455GX-TC	455	1	—	9	25	1	—	6	25	25	—	1500
CFUCG455HX-TC	455	1	—	6	20	1	—	7	25	25	—	1500
SFGCG455AX-TC	455	2.0	—	35	80	1	—	4	25	15	—	1000
SFGCG455BX-TC	455	1.5	—	30	70	1	—	5	25	15	—	1000
SFGCG455CX-TC	455	1.5	—	25	60	1	—	6	25	15	—	1000
SFGCG455DX-TC	455	1	—	20	50	1	—	7	23	20	—	1500
SFGCG455EX-TC	455	1	—	15	40	1	—	8	23	20	—	1500
SFPC455E-TC01	455	1.5	—	15	30	—	—	6	27	—	—	1500
SFPC455F-TC01	455	1.5	—	12	25	—	—	6	27	—	—	1500
SFPC455G-TC01	455	1	—	9	20	—	—	6	25	—	—	1500
SFPC455H-TC01	455	1	—	6	18	—	—	6	25	—	—	2000
CFWC455CZ-TC	455	—	21 to 26	—	—	0.5	± 10.5	6	50	27	± 10.5	1000
CFWC455CZ2-TC	455	—	18 to 22	—	—	0.5	± 9	6	50	27	± 9	1000

**DIMENSIONS: mm
CFUCG/SFGCG**

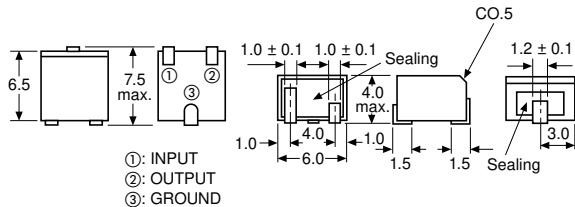

SFPC

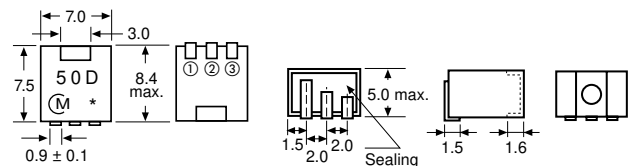

SPECIFICATIONS

CFWC

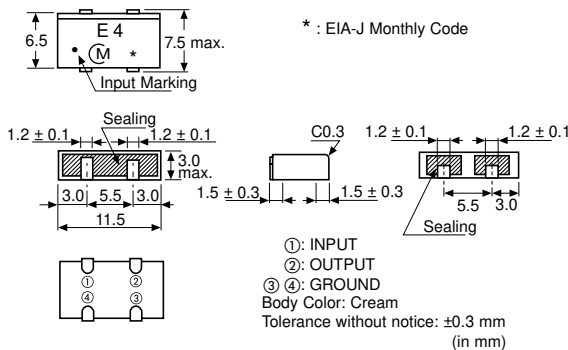

TEST CIRCUIT

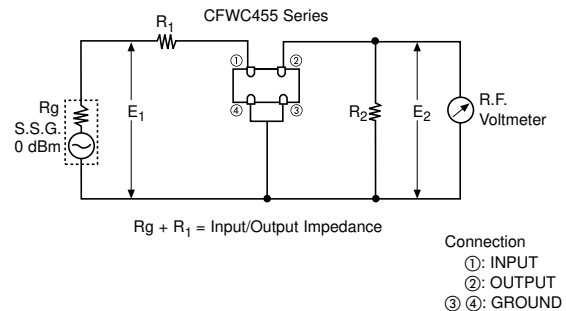

*Note: For safety purposes, connect the output of filters to the IF amplifier through a DC blocking capacitor. Avoid applying a direct current to the output of ceramic filters.

PIEZO FILTERS

SURFACE MOUNTED CHIP PIEZOELECTRIC CERAMIC FILTERS FOR AM APPLICATIONS



SFGCG, SFPC, CFUCG, CFWC 455kHz

CHARACTERISTICS (TYP.)

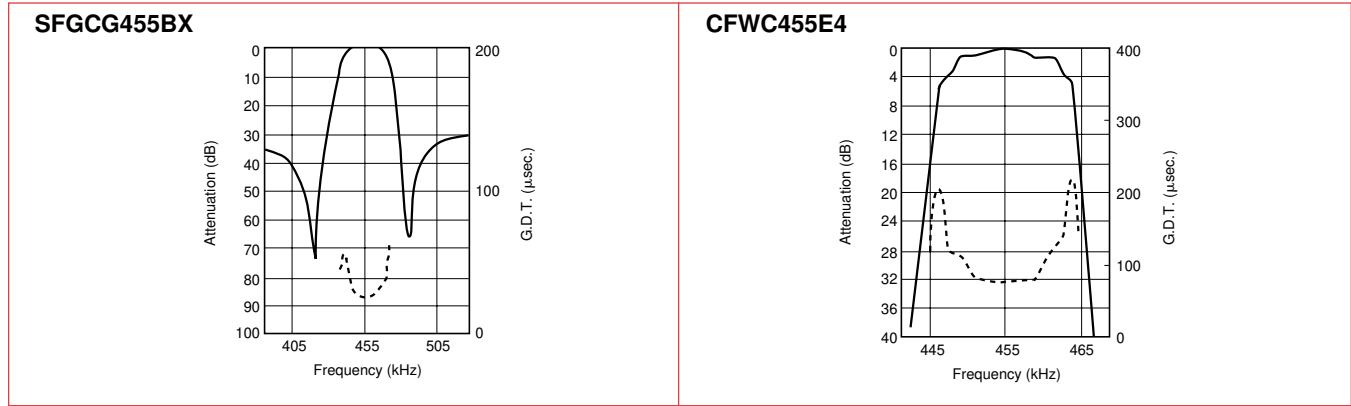

PAD DIMENSIONS: mm

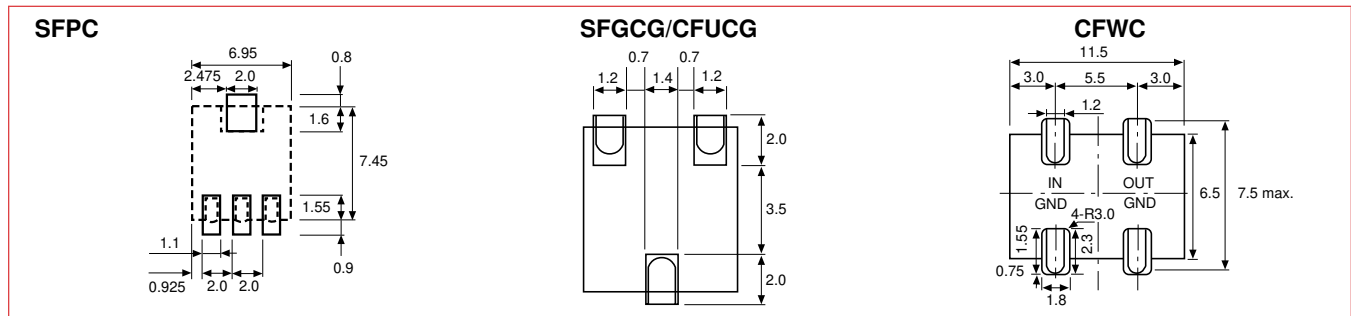

PLASTIC TAPE DIMENSIONS: mm

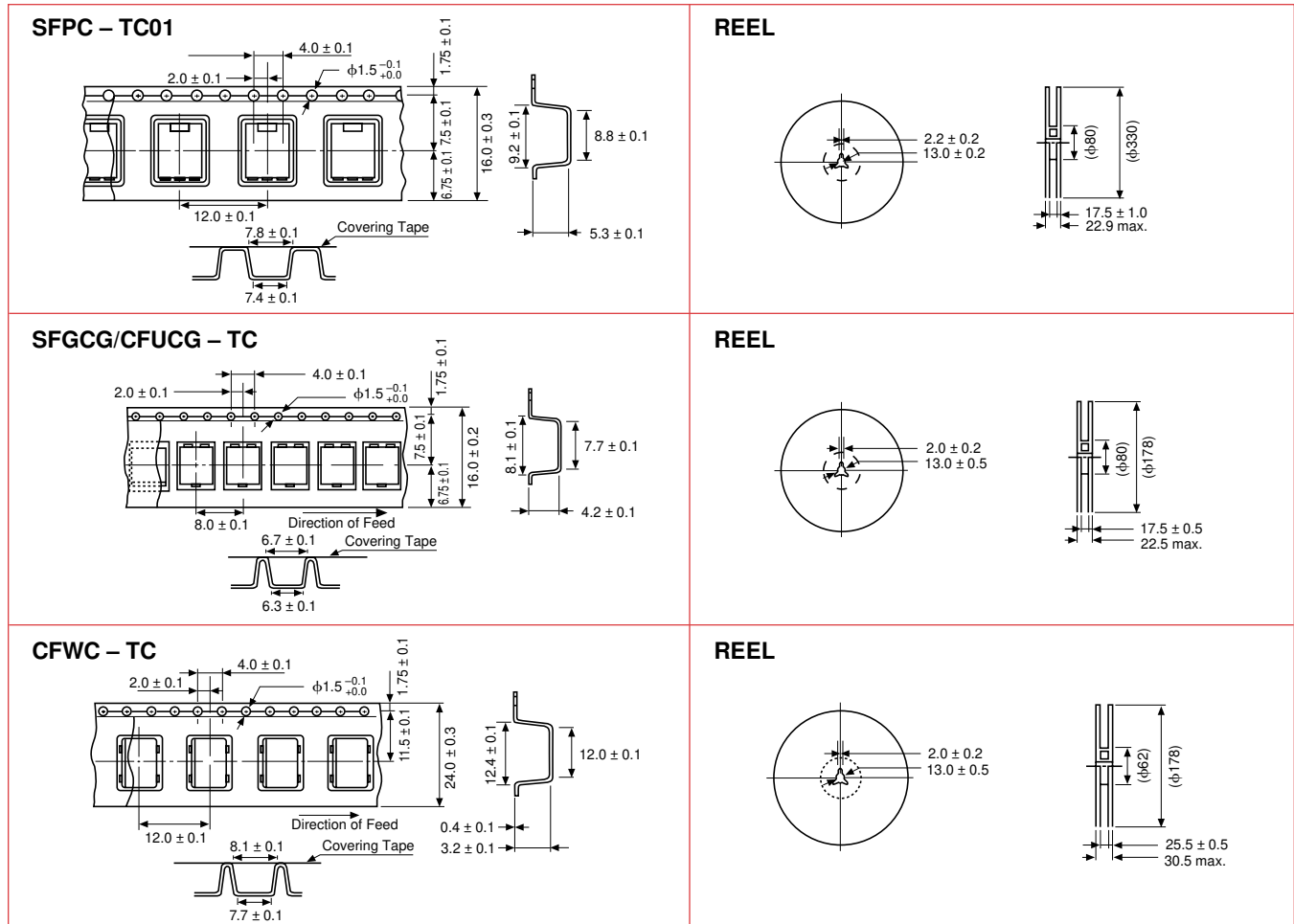

PIEZO FILTERS

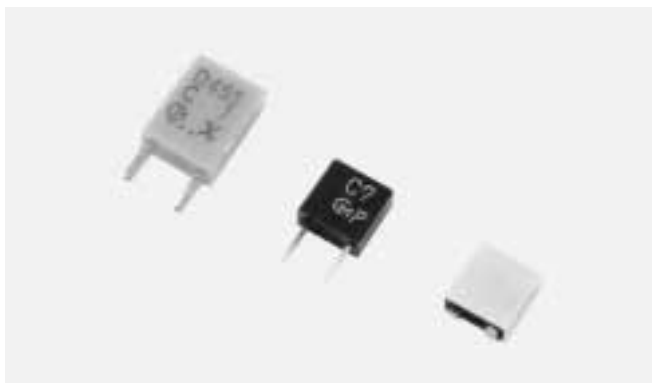

Ceramic discriminator consists of wide band piezoelectric resonator. It is ideal for mobile communication equipment due to its small size and light weight. Standard line includes products for a wide range of applications, from cordless telephones to cellular telephones, making non-adjustment and shrinking of the detection circuit possible.

FEATURES

- Small in size and light weight
- Realize non-adjustment in detection circuit
- High sensitivity and stability
- Wide range of standard products are available for various ICs
- Operating temperature range: -20°C to $+80^{\circ}\text{C}$
Storage temperature range: -40°C to $+85^{\circ}\text{C}$

RECOVERED AUDIO CURVE SPECIFICATIONS

CDB/CDBC/CDBM 455kHz

Part Number/ Characteristics	Recovered Audio		Distortion		IC	Application
	3dB Bandwidth (from 544kHz) min.	Output (at 455kHz)	(at 455kHz) max.	within 455 ± 8kHz		
CDB455C7	±4.0	340 ± 60mV	2.5%	—	MC3357	Cordless Telephone, Communications Equipment
CDBM455C7	±4.0	340 ± 60mV	3.0%	—		
CDBC455CX7	±4.0	350 ± 60mV	3.0%	—		
CDB455C9	±5.0	100mV min.	1.5%	—	NE604N	Cordless Telephone, Cellular Phone, Communications Equipment
CDBM455C9	±5.0	100mV min.	1.5%	—		
CDBC455CX9	±4.0	120 ± 40mV	1.5%	—		
CDB455CL9	±15.0	70 ± 20mV	1.5%	3.5% max.		
CDBM455CL9	±15.0	70 ± 20mV	1.5%	3.5% max.	CXA1003BM	Cellular Phone, Communications Equipment
CDB455C13A	±4.0	350 ± 50mV	3.0%	—		
CDBM455C13A	±4.0	350 ± 50mV	3.0%	—		
CDBC455CX13	±4.0	330 ± 50mV	4.0%	—		
CDB455CL13	±15.0	110 ± 30mV	1.5%	5.0% max.		
CDBM455CL13	±15.0	110 ± 30mV	1.5%	5.0% max.		
CDBC455CLX13	±13.0	120 ± 30mV	1.5%	5.0% max.	MC3372	Cellular Phone, Cordless Telephone, Communications Equipment
CDB455C16	±4.0	185 ± 40mV	2.0%	—		
CDBM455C16	±4.0	185 ± 40mV	2.0%	—		
CDBC455CX16	±4.0	175 ± 40mV	2.0%	—	MC3371	Cordless Telephone, Communications Equipment
CDBM455C18	±3.0	180 ± 40mV	2.0%	—		
CDB455C21	±4.0	55 ± 20mV	2.0%	—	TA31132	Cordless Telephone, Cellular Phone, Communications Equipment
CDBM455C21	±4.0	55 ± 20mV	2.0%	—		
CDBC455CX21	±4.0	55 ± 20mV	2.0%	—		
CDB455CL21	±13.0	65 ± 20mV	2.5%	5.0% max.		
CDBM455CL21	±13.0	65 ± 20mV	2.5%	5.0% max.		
CDBC455CLX21	±11.0	75 ± 25mV	2.5%	5.0% max.		
CDB455C24	±4.0	100 ± 40mV	2.0%	—	TA31136	Cordless Telephone, Communications Equipment
CDBM455C24	±4.0	100 ± 40mV	2.0%	—		
CDBC455CX24	±4.0	100 ± 40mV	2.0%	—		
CDB455C27	±4.0	100 ± 40mV	2.0%	—	TK10487	Cordless Telephone, Communications Equipment
CDBM455C27	±4.0	100 ± 40mV	2.0%	—		
CDBC455CX27	±4.0	90 ± 30mV	2.0%	—		
CDB455C28	±4.0	40 ± 20mV	3.0%	—	TA31142	Pager
CDBM455C28	±4.0	40 ± 20mV	3.0%	—		
CDBC455CX28	±4.0	40 ± 20mV	3.0%	—		

RECOVERED AUDIO CURVE SPECIFICATIONS

CDB/CDBC/CDBM 455kHz

Part Number/ Characteristics	Recovered Audio		Distortion		IC	Application
	3dB Bandwidth (from 455kHz) min.	Output (at 455kHz)	(at 455kHz) max.	within 455 ± 8kHz		
CDB455C29	±4.0	125 ± 30mV	2.5%	—	NE605	Cordless Telephone, Communications Equipment
CDBM455C29	±4.0	125 ± 30mV	2.5%	—		
CDBC455CX29	±4.0	100 ± 30mV	2.5%	—		
CDB455C30	±4.0	90 ± 30mV	2.0%	—	TK14501	Telephone, Communications Equipment
CDBM455C30	±4.0	90 ± 30mV	2.0%	—		
CDBC455CX30	±4.0	80 ± 20mV	2.0%	—		
CDB455C32	±4.0	40 ± 20mV	3.0%	—	TA31143	Pager
CDBM455C32	±4.0	40 ± 20mV	3.0%	—		
CDBC455CX32	±4.0	40 ± 20mV	3.0%	—		
CDB455C34	±4.0	65 ± 20mV	2.5%	—	MC13136	Cordless Telephone, Communications Equipment
CDBM455C34	±4.0	65 ± 20mV	2.5%	—		
CDB455C35	±4.0	100 ± 40mV	2.5%	—	TK10930	Cordless Telephone, Communications Equipment
CDBM455C35	±4.0	100 ± 40mV	2.5%	—		
CDBC455CX35	±4.0	100 ± 40mV	2.5%	—		
CDBM455C36	±3.5	100 ± 25mV	3.5%	—	NE(SA)606, NE(SA)616	Cordless Telephone, Cellular Phone
CDBC455CLX36	±13.0	90 ± 30mV	2.5%	5.0% max.		
CDBM455C39	±4.0	85 ± 20mV	2.5%	—	NE(SA)607/617	Cordless Telephone
CDBC455CLX39	±11.0	130 ± 20mV	2.5%	7.0% max.		
CDBM455C40	±4.0	40 ± 20mV	3.0%	—	TA31145	Pager
CDBC455CX40	±4.0	40 ± 20mV	3.5%	—		
CDB455C42	±4.0	40 ± 15mV	3.0%	—	TK14590, TK14591	Pager
CDBM455C42	±4.0	40 ± 15mV	3.0%	—		
CDBM455C49	±4.0	45 ± 10mV	3.0%	—	MC3361	Cordless Telephone
CDBC455CX49	±4.0	45 ± 10mV	3.0%	—		
CDBM455C50	±4.0	64 ± 6.4mV	4.0%	—	CXA3117	Pager
CDBC455CX50	±4.0	64 ± 6.4mV	4.0%	—		
CDBC455C52	±3.0	65 ± 25mV	3.0%	—	SA625	Communications Equipment
CDBC455C55	±3.0	40 ± 15mV	3.0%	—	SA608D	Communications Equipment
CDBC455C56	±4.0	100 ± 20mV	2.0%	—	BA4116FV	Communications Equipment

IMPEDANCE CURVE SPECIFICATIONS

CDB/CDBC/CDBM 455kHz

Part Number/ Characteristics	Resonant Frequency (Fr)	Antiresonant Frequency (Fa)	ΔF (Fa-Fr)	Resonant Resistance (R1)	Capacitance (C)	IC	Application
CDBM455C2	447 ± 1.5kHz (Z = 2.05kΩ)		463 ± 1.5kHz (Z = 10.0kΩ)		140pF ± 20%	TA8104F	Pager
CDBC455CX2	447 ± 1.5kHz (Z = 0.80kΩ)		463 ± 1.5kHz (Z = 3.65kΩ)		280pF ± 20%		
CDB455C3	—	455 ± 1.5kHz	48 ± 5.0kHz	70Ω max.	600pF ± 20%	CXA1184M	Pager
CDBM455C3	—	455 ± 1.5kHz	46 ± 5.0kHz	70Ω max.	550pF ± 20%		
CDBM455C4	—	470 ± 1.0kHz	43 ± 2.0kHz	300Ω max.	140pF ± 20%	LA8610	Pager
CDB455C10	429 ± 2kHz	—	51 ± 5.0kHz	70Ω max.	580pF ± 20%	TA8103F	Cordless Telephone
CDBM455C10	429 ± 2kHz	—	51 ± 5.0kHz	70Ω max.	580pF ± 20%		
CDBM455C15	—	463.5 ± 1kHz	43 ± 2.0kHz	300Ω max.	140pF ± 20%	CXA1183M	Cordless Telephone
CDBM455C25	—	465 ± 1.5kHz	45 ± 4.0kHz	300Ω max.	135pF ± 20%	CXA1484	Pager
CDBM455C31	447 ± 1.5kHz (Z = 2.05kΩ)		463 ± 1.5kHz (Z = 10.0kΩ)		140pF ± 20%	TA31141	Pager
CDBC455CX31	447 ± 1.5kHz (Z = 0.80kΩ)		463 ± 1.5kHz (Z = 3.65kΩ)		280pF ± 20%		
CDBM455C33	—	465 ± 1.5kHz	45 ± 4.0kHz	300Ω max.	135pF ± 20%	CXA1474	Pager

DIMENSIONS: mm

CDB455C□/ CDB455CL□

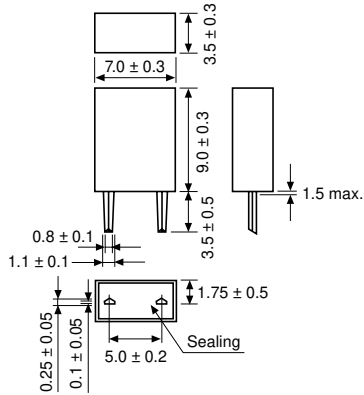

Applicable Part Number: All

CDBM455C□/ CDBM455CL□

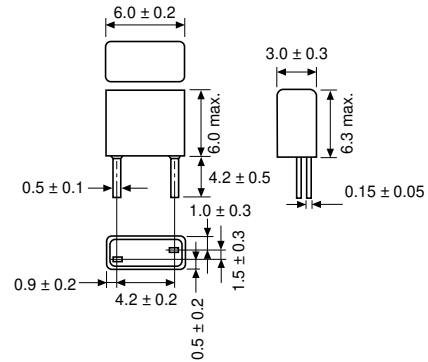

Applicable Part Number: 3, 7, 9, 10, 13, 21, 24, 27, 28, 29, 30, 32, 34, 35, 40, 42, 47, 49, 50

CDBM455C□

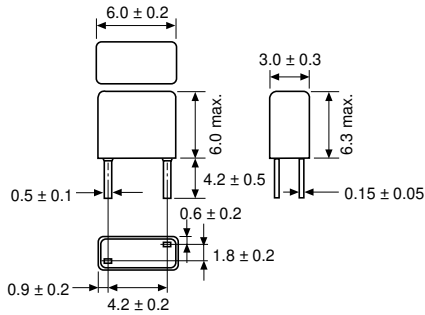

Applicable Part Number: 2, 4, 15, 16, 18, 25, 31, 33, 36, 39

CDBC455CX□/ CDBC455CLX□

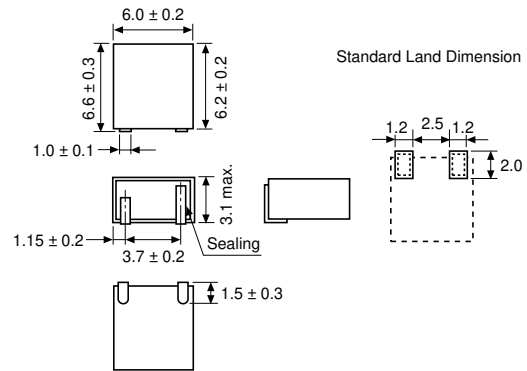

Applicable Part Number: All

PLASTIC TAPE DIMENSIONS: mm

CDBC455C□ – TC

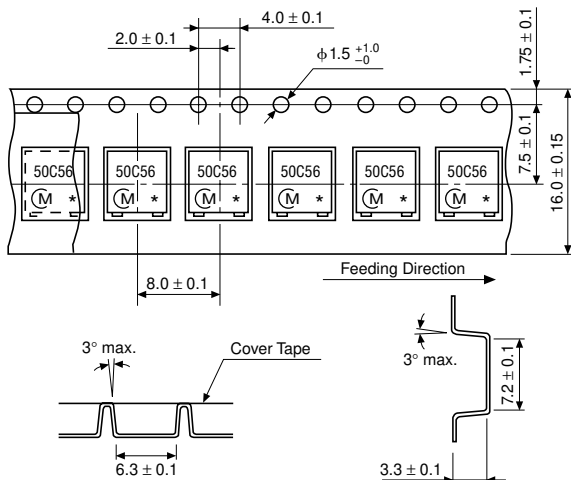

The marked part number is faced on the cover tape side.

Reel

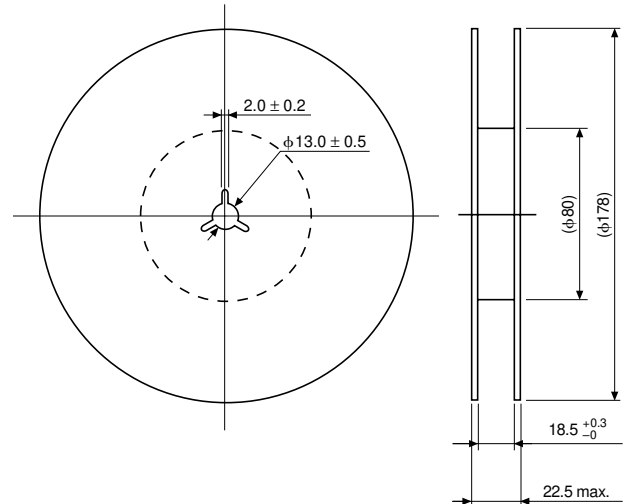



The following filters were specifically designed for signal detection circuitry used in applications such as that found in the search-stop functions of electronically tuned radios.

SPECIFICATIONS

SFE 10.7

Part Number	Center Freq. (MHz)	3dB Bandwidth (kHz)	Insertion Loss (dB max.)	Terminal Impedance (Ohms)
SFE10.7MFP1	10.7 (Nominal)	$F_n \pm 5$ min. $F_n \pm 35$ max.	6	470

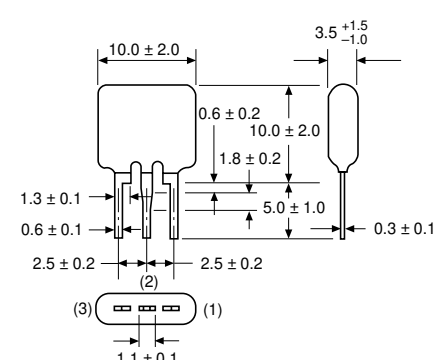
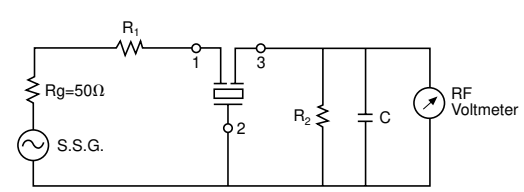
DIMENSIONS: mm	CIRCUIT
	 <p>$R_1 + R_g = R_2 = \text{Input/Output Impedance}$ $C = 10\text{pF} \pm 2\text{pF}$ (including stray capacitance and input capacitance of RF Voltmeter.)</p> <p>1=INPUT 2=GROUND 3=OUTPUT</p>

SPECIFICATIONS

BFU 450/455

Part Number	Resonant Frequency (kHz)	Resonant Resistance (Ohms)	Δf (fa-fr) (kHz)
BFU450K3	450 ± 1	30	27.5 ± 4.5
BFU450C	450 ± 1	20	14 ± 2
BFU450C4N	450 ± 0.8	30	9 ± 2

• Temperature Coefficient is typically 10ppm/°C

Part Number	Center Frequency (kHz)	3dB Bandwidth (kHz)	Selectivity
BFU455K	455 ± 2	8 ± 2	8dB @ $f_0 - 9$, 12dB @ $f_0 + 9$

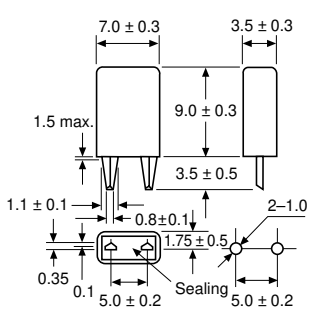
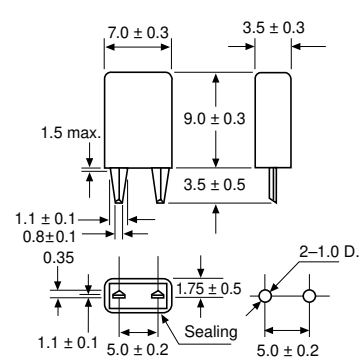
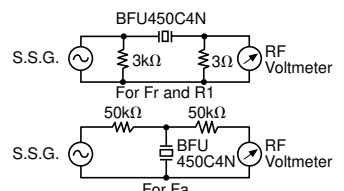
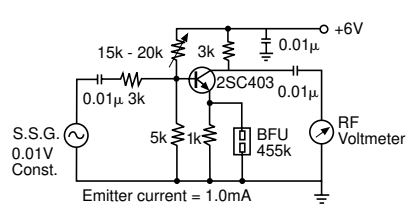
DIMENSIONS: mm	DIMENSIONS: mm	CIRCUIT
<p>BFU450K3/C/C4N</p> 	<p>BFU455K</p> 	<p>BFU450K3/C/C4N</p>  <p>BFU455K</p>  <p>Emitter current = 1.0mA</p>

PIEZO FILTERS

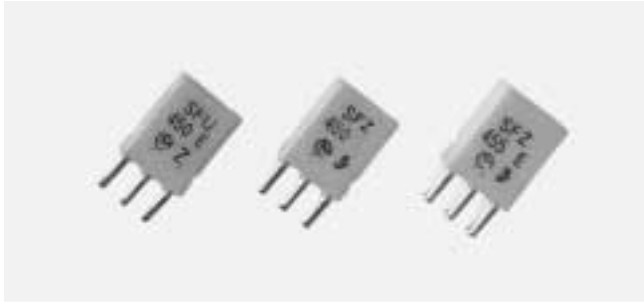

The following filters were designed to address the needs of standard AM filtering requirements. These filters are recommended for use in low cost products where economically, efficient designs are critical.

SPECIFICATIONS

SFU/SFZ/450/455kHz

Part Number	Center Frequency (kHz)	3dB Bandwidth (kHz)	Ripple (dB) max.	Selectivity $F_0 \pm 9\text{kHz}$	Termination Impedance (Ohms) max.	Spurious Response (dB) min.	Insertion Loss (dB) max.	Operating Temperature Range	Withstanding Voltage
*SFU455A	455 ± 2	$10 (\pm 3)$	0	4@-10kHz 6@+10kHz	3k	10 (1~3MHz)	5	-10°C to +80°C	50V DC
SFU455B (connected to an IFT)	462 ± 2	$10 (\pm 3)$	—	4@+10kHz 6@-10kHz	3k	10 (1~3MHz)	5	-10°C to +80°C	
SFZ455HL	455.5 ± 2	4.0 ± 1.0	1.5	23dB min.	3k	20 ($F_0 \sim 3\text{MHz}$)	7.0	-20°C to +80°C	
SFZ455JL	456 ± 2	5.5 ± 1.0	1.5	18dB min.	3k	20 ($F_0 \sim 3\text{MHz}$)	7.0	-20°C to +80°C	
SFZ450C3N	450 ± 1	$2.5 (\pm 1)$	—	30@-9kHz 24@+9kHz	3k	F_0 20 (1~3MHz)	6.5	-10°C to +80°C	

() Typ. value

DIMENSIONS: mm

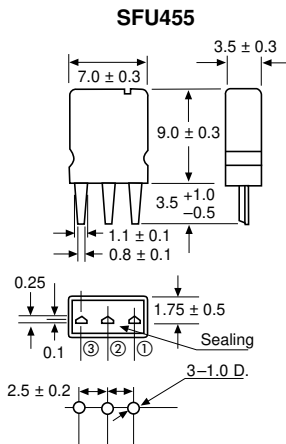

DIMENSIONS: mm

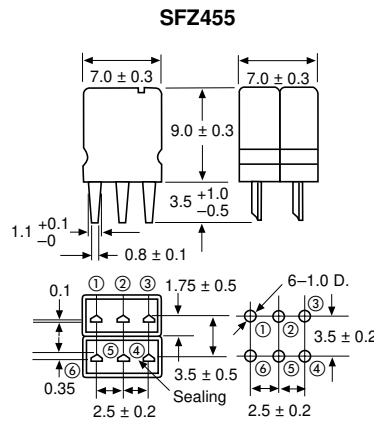

DIMENSIONS: mm

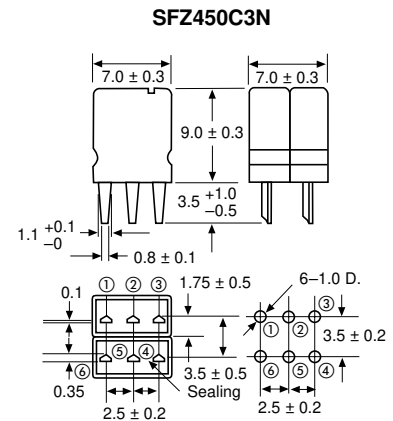

CIRCUIT

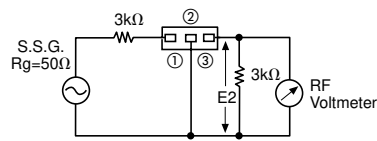

SFU455B is designed to be connected with an I.F.T.

CIRCUIT

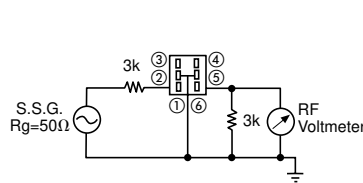

CIRCUIT

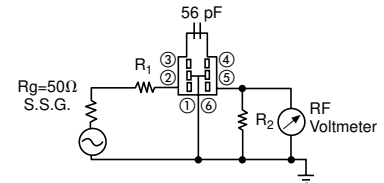

$R_g + R_1 = R_2 = \text{Input/Output Impedance}$

* Available as standard through authorized Murata Electronics Distributors.

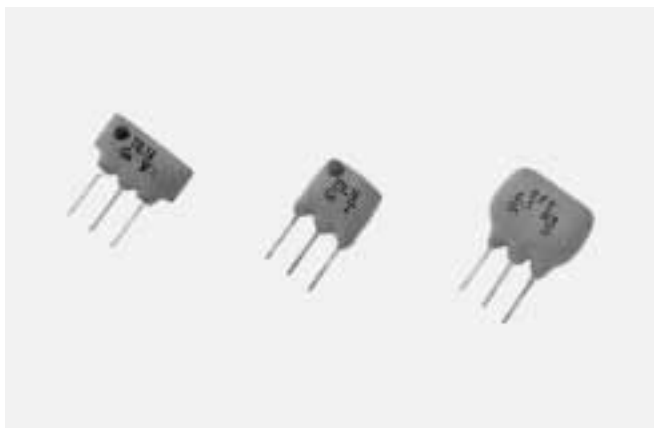

Murata Electronics' MHz series of ceramic filters are monolithic devices which utilize the energy-trapped thickness vibration-mode. This principle of operation is based upon the fact that an excellent resonating element with low spurious vibration can be obtained by adhering to certain theoretical parameters of design. These parameters include the physical dimensions of the ceramic element, the electrode pattern, and the associated mass loading effect of the electrodes.

In addition to employing the principle of energy-trapped thickness shear vibration-mode, Murata also utilizes the theory of the multicoupling mode. In short, this theory utilizes divided electrodes to "trap" different frequencies simultaneously.

The advantages of Murata's multicoupling mode technology is a highly selective, integrated ceramic filter that allows a single ceramic substrate to contain a number of coupled resonators.

Murata categorizes the SFE 10.7 family of ceramic filters according to rank of center frequency. This ranking indicates that a given SFE 10.7 filter will be marked with one of the colors listed in the following chart and will exhibit the center frequency characteristics specified below.

AVAILABLE CENTER FREQUENCY

Category	Color Code	Center Frequency (MHz)
-A	RED (ONLY)	10.70MHz, ±30kHz
-Z	RED, BLUE, ORANGE, BLACK OR WHITE*	10.70MHz, ±90kHz

*Note: Center Frequency Color Code Information—Blue (-B) = 10.67MHz ± 30kHz, Orange (-C) = 10.73MHz ± 30kHz, Black (-D) = 10.64MHz ± 30kHz, White (-E) = 10.76MHz ± 30kHz

PIEZO FILTERS CERAMIC FILTERS LOW LOSS, HIGHLY SELECTIVE, MINIATURE



SFE MA/MS/MJ/MH 10.7MHz

The standard SFE 10.7 line of ceramic filters are extremely reliable devices that exhibit excellent waveform symmetry. These filters have traditionally found wide application in FM receiver technology.

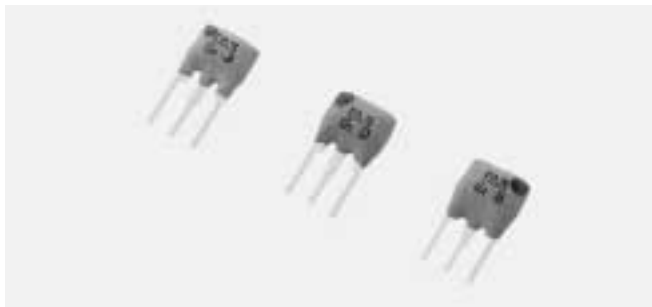

SPECIFICATIONS

SFE MA/MS/MJ/MH 10.7MHz

	Part Number	3dB Bandwidth (kHz)	20dB Bandwidth (kHz) max.	Ripple (dB) max.	Insertion Loss (dB) max.	Spurious (9 ~ 12MHz) (dB) min.
FM-IF	SFE10.7MA5-A	280 ± 50	650 (520)	1	6 (4)	30 (43)
	SFE10.7MS2-A	230 ± 50	600 (420)	1	6 (4)	40 (45)
	SFE10.7MS3-A	180 ± 40	520 (380)	1	7 (4.5)	40 (45)
• Input/output impedance: 330Ω						() Typ. value
A10 Series	SFE10.7MA5A10-A	280 ± 50	590 (480)	1	2.5 ± 2.0	30 (42)
	SFE10.7MS2A10-A	230 ± 50	520 (400)	1	3.0 ± 2.0	35 (43)
	SFE10.7MS3A10-A	180 ± 40	470 (360)	1	3.5 ± 1.5	35 (43)
	SFE10.7MJA10-A	150 ± 30	360 (290)	1	4.5 ± 2.0	35 (44)
• Input/output impedance: 330Ω • Low loss and high selectivity.						() Typ. value
B10 Series	SFE10.7MA5B10-A	280 ± 50	650	1	3.0 ± 2.0	45
	SFE10.7MS2B10-A	230 ± 50	570	1	3.0 ± 2.0	45
	SFE10.7MS3B10-A	180 ± 40	520	1	5.0 ± 2.0	45
• Input/output impedance: 330Ω • High attenuation type						() Typ. value
C10 Series	SFE10.7MA5C10-A	280 ± 50	650 (540)	1	3.0 ± 2.0	30 (47)
	SFE10.7MS2C10-A	230 ± 50	570 (470)	1	3.0 ± 2.0	40 (48)
	SFE10.7MS3C10-A	180 ± 40	470 (360)	1	3.5 ± 2.0	35 (45)
	SFE10.7MJC10-A	150 ± 40	360 (300)	1	4.5 ± 2.0	35 (48)
	SFE10.7MHC10-A	110 ± 30	350 (260)	1	7.0 ± 2.0	30 (42)
• Input/output impedance: 330Ω • Most suitable for a thin type and low profile set. • The performance is the same as that of conventional types.						() Typ. value

MA5 Series

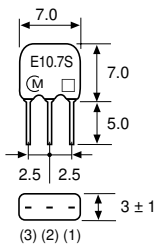

UNIT: mm

MA5A10 Series

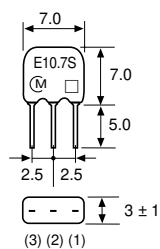

UNIT: mm

MA5C10 Series

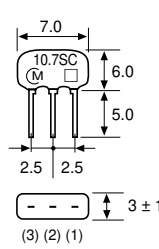

UNIT: mm

CIRCUIT

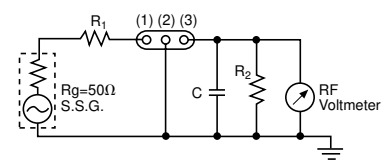

$R_g + R_1 + R_2 = 330\Omega \pm 5\%$
 $C = 10\text{pF}$
 (including stray capacitance and input capacitance of RF Voltmeter)

1=INPUT
 2=GROUND
 3=OUTPUT

FREQUENCY CHARACTERISTICS

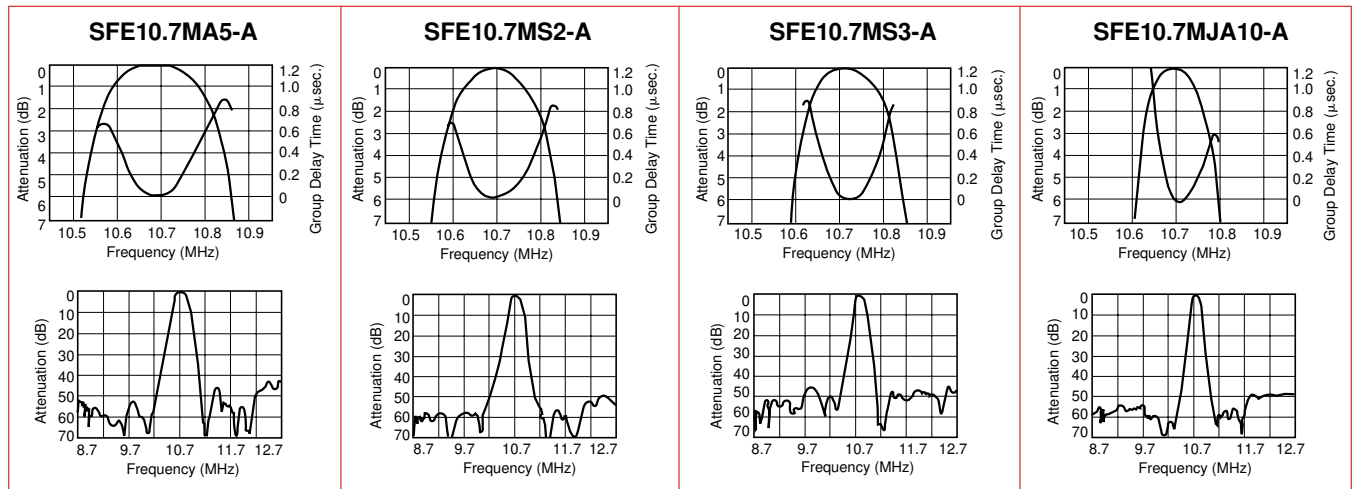

* Available as standard through authorized Murata Electronics Distributors.

PIEZO FILTERS

CERAMIC FILTERS HIGHLY SELECTIVE

G.D.T. FLAT TYPE

SFE MX/MA8/ML 10.7MHz



The SFE 10.7MX/MA8/ML lines of ceramic filters were designed to minimize the dispersion of amplitude and phase characteristics within the pass band. Because the excellent G.D.T. characteristics of these filters insure signal integrity, they are recommended for use in applications ranging from high grade stereo receivers to digital transmission systems.

SPECIFICATIONS

SFE MX/MA8/ML 10.7MHz

	Part Number	3dB Bandwidth (kHz)	20dB Bandwidth (kHz) max.	Insertion Loss (dB) max.	Spurious (9-12MHz) (dB) min.	Ripple w/n 3dB Bandwidth (dB)	G.D.T. Bandwidth (kHz) min.
MX Series	SFE10.7MX-A	250 ± 40	670 (620)	12 (10)	25 (33)	0 max.	0.2μ sec. fo ±110kHz
	SFE10.7MX2-A	220 ± 40	610 (560)	12.5 (10.5)	30 (37)	0 max.	0.15μ sec. fo ±80kHz
	SFE10.7MZ1-A	180 ± 30	530 (460)	14 (12.3)	33 (38)	0 max.	0.15μ sec. fo ±60kHz
	SFE10.7MZ2-A	150 ± 30	500 (420)	14 (12.6)	35 (41)	0 max.	0.15μ sec. fo ±50kHz
MA8 Series	SFE10.7MA8-A	280 ± 50	650 (520)	6 (4)	30 (43)	0.5 max.	0.5μ sec. fo ±80 (±100)
	SFE10.7MS2G-A	230 ± 50	600 (420)	7 (4.5)	40 (45)	0 max.	0.5μ sec. fo ±60 (±75)
	SFE10.7MS3G-A	180 ± 40	520 (380)	9 (5)	40 (45)	0 max.	0.5μ sec. fo ±45 (±60)
ML Series	SFE10.7ML-A	280 ± 50	650 (610)	9 (7)	25 (33)	0 max.	0.25μ sec. fo ±70 (±105)
	SFE10.7MP3-A	250 ± 50	650 (550)	10 (8)	30 (35)	1.0 max.	0.25μ sec. fo ±65 (±90)
	SFE10.7MM-A	230 ± 50	600 (510)	11 (9)	30 (38)	0 max.	0.25μ sec. fo ±60 (±85)

- Input/output impedance: 330Ω
- The rank of center frequency is available in two series: 30kHz steps and 25kHz steps.
- The G.D.T. waveforms of all these types are controlled.

() Typ. value

MX Series

⊖ : EIA-J Date Code

MA8 Series

⊖ : EIA-J Date Code

ML Series

⊖ : EIA-J Date Code

CIRCUIT

$R_1 + R_g + R_2 = 330\Omega$
 $C = 10\text{pF}$
 (including stray capacitance and input capacitance of RF Voltmeter)

FREQUENCY CHARACTERISTICS

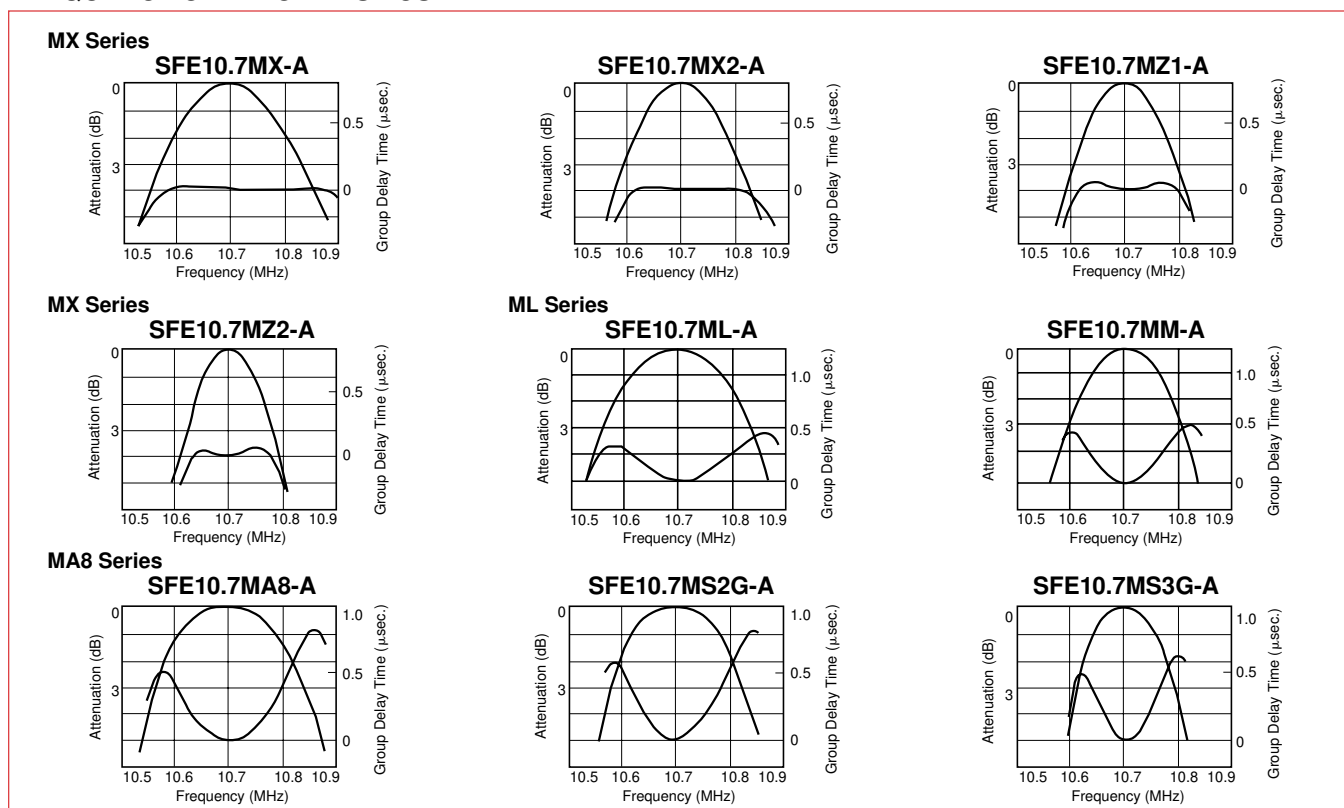

* Available as standard through authorized Murata Electronics Distributors.

PIEZO FILTERS

PIEZO FILTERS

CERAMIC FILTERS LOW LOSS, WIDE OR NARROW BAND, MINIATURE

SFE MA/MTE/MVE/MFP 10.7MHz

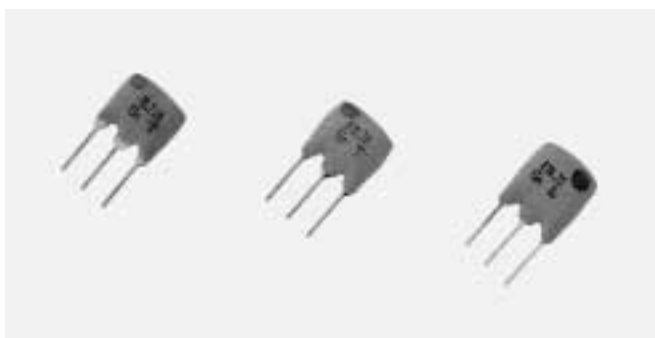

The following filters were developed to offer both narrower and wider bandwidth characteristics for use in products such as DBS receivers. These filters also retain the same reliability that is available with our standard filters. The various bandwidths allow these filters to be utilized in a multitude of new communication applications.

SPECIFICATIONS

SFE MX/MA8/ML 10.7MHz

	Part Number	3dB Bandwidth (kHz)	20dB Bandwidth (kHz) max.	Ripple Within 3dB Bandwidth (dB)	Insertion Loss (dB) max.	Spurious (9 ~ 12MHz) (dB) min.
Wide Bandwidth Series	SFE10.7MA19	350 min. (450)	950 (750)	3 max.	3 ± 2	20 (30)
	SFE10.7MA20-A	330 ± 50	680 (615)	1 max.	4 ± 2	30 (40)
	SFE10.7MA21	400 (500)	950 (750)	3 max.	3 ± 2	20 (30)
	SFE10.7MHY-A	110 ± 30	350 (260)	1 max.	7 ± 2	30 (42)
Narrow Bandwidth Series	SFE10.7MTE	±25 (82)	200 (160)	1 max.	5.5 ± 2.5	30 (48)
	SFE10.7MVE	±13 (56)	135 (110)	1 max.	5.5 ± 2.0	30 (41)
	SFE10.7MFP	±20 (36)	95 (77)	1 max.	6.0 (2.5)	24 (28)

- Input/output impedance: 330Ω (MA20-A, MHY-A), 470Ω (MA19) () Typ. value
- Center frequency 10.52MHz types of SFE10.7MHY-A is also available.

- Input/output impedance: 330 (MT, MV), 600Ω (MFP)
- Spurious range of SFE10.7MFP: 10.7 ± 1MHz. () Typ. value

MA19 Series	MTE Series	MVE Series	MFP Series	CIRCUIT
				<p> $R_g + R_1 = R_2 = \text{Input/Output Impedance}$ $C = 10\text{pF}$ (including stray capacitance and input capacitance of RF Voltmeter) </p> <p> 1=INPUT 2=GROUND 3=OUTPUT </p>
: EIA-J Date Code	: EIA-J Date Code	: EIA-J Date Code	: EIA-J Date Code	

FREQUENCY CHARACTERISTICS

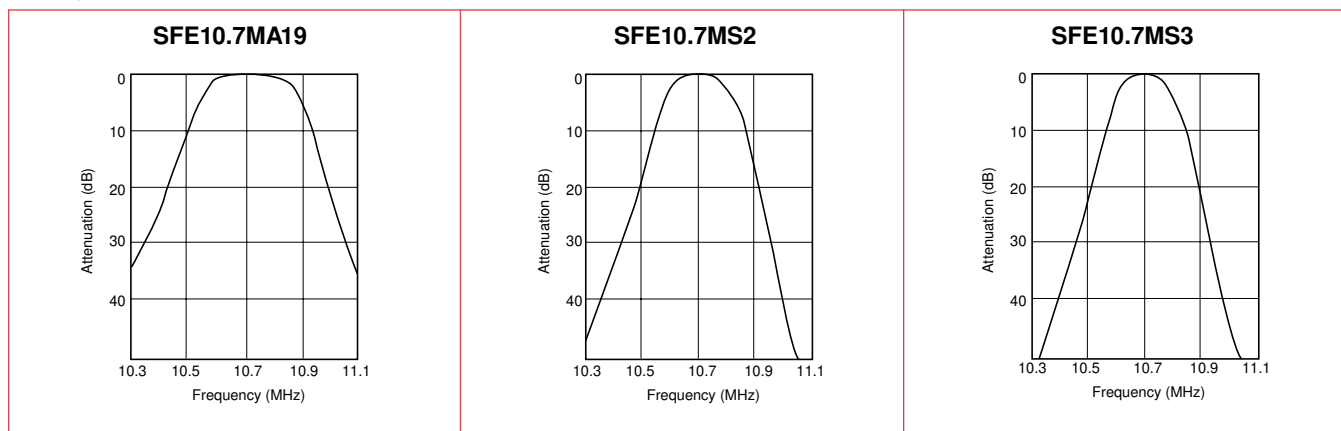

* Available as standard through authorized Murata Electronics Distributors.

PIEZO FILTERS

CERAMIC FILTERS HIGHLY SELECTIVE, 3 ELEMENT TYPE

SFT MA/MS 10.7MHz

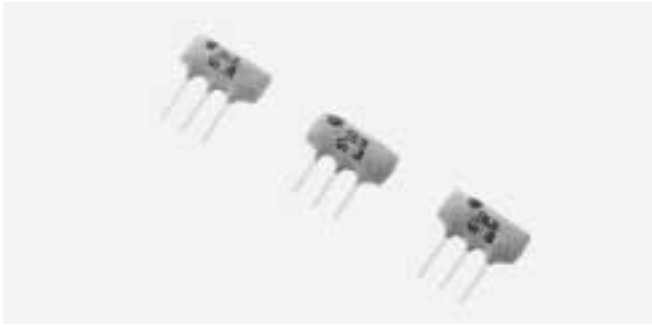

The SFT 10.7 ceramic filters are single substrate, 3 element devices that offer 1.5 times more selectivity than the conventional SFE Series of filters. The improved spurious suppression of these filters eliminates the need for cascading multiple filtering devices; therefore, it is possible to design a more compact circuit board configuration.

SPECIFICATIONS

SFT MA/MS 10.7MHz

Part Number	3dB Bandwidth (kHz)	40dB Bandwidth (kHz) max.	Ripple within 3dB Bandwidth (dB)	Insertion Loss (dB) max.	Spurious Attenuation (9 to 12MHz) (dB) min.
SFT10.7MA5	280 ± 50	700 (630)	0.5 max.	6 ± 2	50 (60)
SFT10.7MS2	230 ± 40	650 (580)	0.5 max.	6 ± 2	50 (60)
SFT10.7MS3	180 ± 40	550 (500)	0.5 max.	8 ± 2	50 (60)

• Input/output impedance: 330Ω

• High selectivity is achieved by replacing with SFT10.7 series

() Typ. value

DIMENSIONS: mm

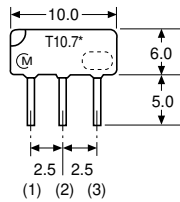

*Varies by part number

CIRCUIT

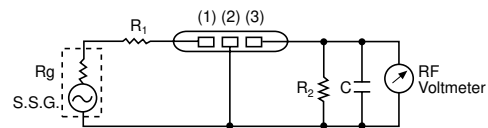

$R_g + R_1 = 330\Omega$
 $C = 10\text{pF}$
(including stray capacitance and input capacitance of RF Voltmeter.)

1=INPUT
2=GROUND
3=OUTPUT

FREQUENCY CHARACTERISTICS

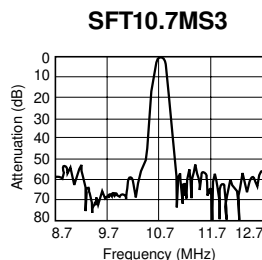
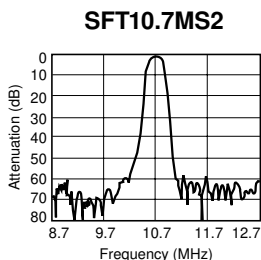
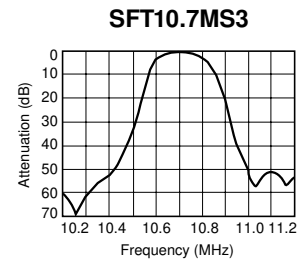
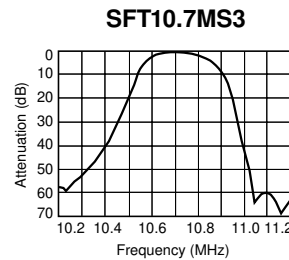
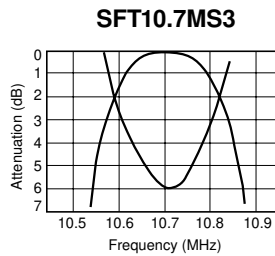
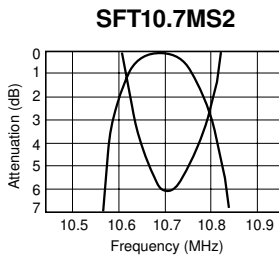

TYPICAL SPURIOUS RESPONSE CHARACTERISTICS SFT10.7MS2

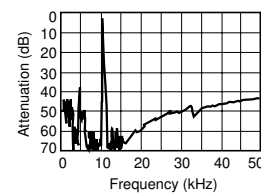

*Available as standard through authorized Murata Electronics Distributors.

PIEZO FILTERS
CERAMIC FILTERS
ULTRA-WIDE BANDWIDTH



KMFC545 10.7MHz



New digital applications are pushing the bandwidth requirements wider on 10.7MHz filters. This matched filter pair is designed to be used in applications that require the widest possible bandwidth at 10.7MHz. These applications can include receivers, audio/video equipment, and measurement equipment.

SPECIFICATIONS

KMFC545 10.7MHz

Nominal Center Frequency (fn)	3dB Bandwidth (kHz) min.	20dB Bandwidth (kHz) max.	Insertion Loss (dB) max.	Ripple within 3dB Bandwidth (dB)	Spurious Response (8 ~ 13MHz) (dB) min.	Withstanding Voltage (DC)	Insulation Resistance (M Ohms) min.
10.7MHz	±325	1400	6.0	2.0 max.	23	50V, 1 min.	100 (DC 100V)

• Input/output impedance: 470Ω

DIMENSIONS: mm

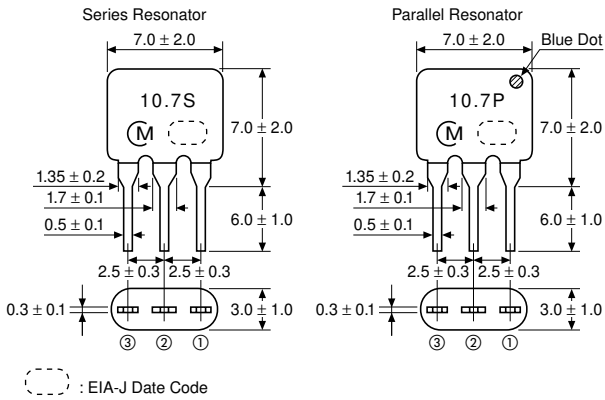

TEST CIRCUIT

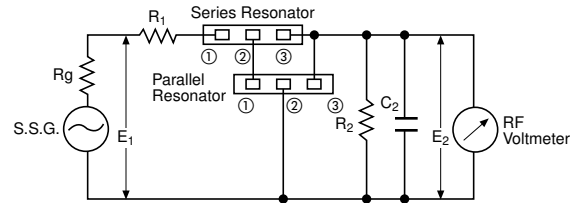

$R_1 = 420\Omega \pm 5\%$; $R_2 = 420\Omega \pm 5\%$; $R_g = 50\Omega$
 $C_2 = 10\text{pF}$ (including stray capacitance and input capacitance of RF Voltmeter)

$$\text{Insertion Loss (dB)} = 20 \cdot \log \left(\frac{E_1}{2 \cdot E_2} \right)$$

- ①: INPUT
- ②: GROUND
- ③: OUTPUT

TAPING DIMENSIONS

SFE10.7M□□- * -TF21

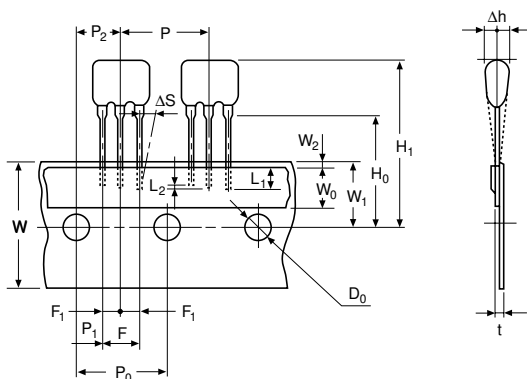

PACKAGING DIMENSIONS: mm

Item	Code	Dimensions (mm)	Note
Adhered Terminal Length	L ₁	3 min.	
	L ₂	2.0 max.	Pay attention to directivity
Pitch of Component	P	12.7 ± 0.5	
Pitch of Sprocket Hole	P ₀	12.7 ± 0.2	
Length from Hole Center to Lead	P ₁	3.85 ± 0.5	
Length from Hole Center to Component Center	P ₂	6.35 ± 0.5	
Lead Spacing (1)	F	5.0 ^{+0.5} _{-0.2}	
Lead Spacing (2)	F ₁	2.5 ± 0.2	
Deviation across Tape	Δh	0 ± 1.0	
Deviation along Tape Left or Right	Δs	0 ± 1.0	
Carrier Tape Width	W	18.0 ± 0.5	
Hold-down Tape Width	W ₀	6.0 min.	Hold-down tape should not overflow the base tape
Position of Sprocket Hole	W ₁	9.0 ± 0.5	
Margin between Both Tapes	W ₂	0 ^{+1.0} ₋₀	
Lead Distance between Reference and Bottom Planes	H ₀	18.0 ± 0.5	
Diameter of Sprocket Hole	D ₀	φ4.0 ± 0.2	
Total Tape Thickness	t	0.6 ± 0.2	

- When packaged, components of different center frequencies are not mixed.
- Compatible with various automatic insertion.
- Flat pack is the standard package type.

PIEZO FILTERS



Along with the development of the AM chip filter, IF filters for AM/FM radios have also been made smaller, thinner and in a chip configuration for surface mounting. This is one more example of Murata Electronics' leadership in converting conventional electronic components to chip technology.

SPECIFICATIONS

SFECV10.7

Part Number	Nominal Center Frequency (fn) (MHz)*	3dB Bandwidth from fn (kHz)	Spurious Attenuation min.	Insertion Loss at fn (dB) max.	Input/Output Impedance (Ohms)
SFECV10.7MA21S-TC	10.7	400 min.	20dB (10.7 to 15.0MHz)	3.0 ±2.0	470
SFECV10.7MA19S-TC	10.7	350 min.	20dB (10.7 to 15.0MHz)	3.0 ±2.0	470
SFECV10.7MA2S-A-TC	10.7	330 ± 50	30dB (9 to 12MHz)	4.0 ±2.0	330
SFECV10.7MA5S-A-TC	10.7	280 ± 50	35dB (9 to 12MHz)	3.0 ±2.0	330
SFECV10.7MS2S-A-TC	10.7	230 ± 50	35dB (9 to 12MHz)	3.5 ±2.0	330
SFECV10.7MS3S-A-TC	10.7	180 ± 40	35dB (9 to 12MHz)	4.0 ±2.0	330
SFECV10.7MJS-A-TC	10.7	150 ± 30	35dB (9 to 12MHz)	5.5 ±2.0	330
SFECV10.7MHS-A-TC	10.7	110 ± 30	35dB (9 to 12MHz)	6.0 ±2.0	330

SFECV10.7 DIMENSIONS: mm

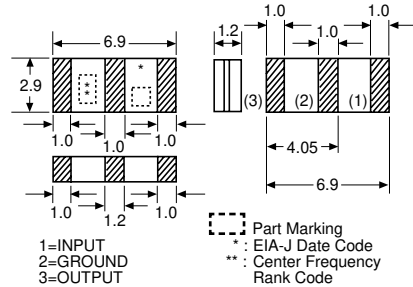

TEST CIRCUIT

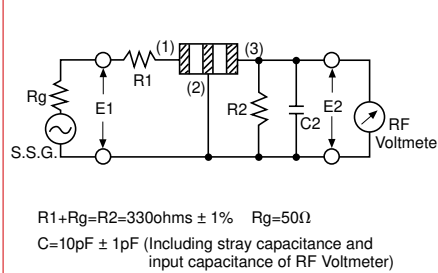

CHARACTERISTICS (Typ.)

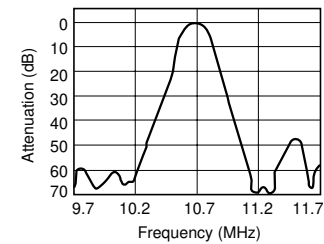

* A: 10.70MHz ± 30kHz Z: 10.70MHz ± 90kHz

Packaging Units: 2000 pcs/reel (180 mmD)

SPECIFICATIONS

CFEC10.8*

Part Number	Nominal Center Frequency (fn) (MHz)	3dB Bandwidth from fn (kHz)	20dB Bandwidth from fn (kHz) max.	Stopband Attenuation fn ± 500kHz (dB) min.	Stopband Attenuation fn ± 1.2kHz (dB) min.	Spurious 9 to 12MHz (dB) min.	Insertion Loss at fn (dB) max.	Ripple (dB) max.	GDT Deviation (μsec) max.	Input/Output Impedance (Ohms)
CFEC10.8MK1-TC	10.8	±110 to ±150	±310	37	35	—	6	(fn ± 100kHz) 0.5	(fn ± 100kHz) 1.5	330
CFEC10.8MG1-TC	10.8	±135 to ±180	±350	32	35	—	6	(fn ± 100kHz) 0.5	(fn ± 100kHz) 1.2	330
CFEC10.8ME11-TC	10.8	±150	±420	—	—	25	5	(fn ± 110kHz) 1	(fn ± 110kHz) 1.5	330
CFEC10.8MD11-TC	10.8	±170	±450	—	—	25	5	(fn ± 170kHz) 1	(fn ± 170kHz) 2.0	600

CFEC10.8 DIMENSIONS: mm

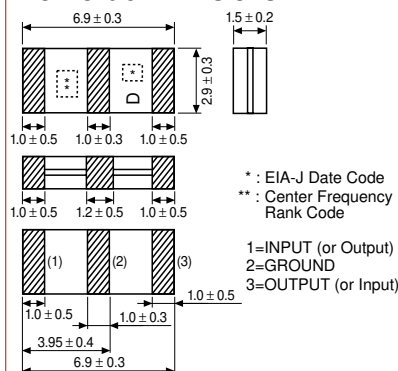

PLASTIC TAPE (for SFECV & CFEC)

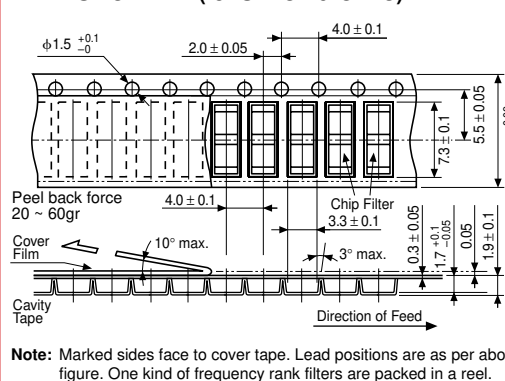

PLASTIC REEL

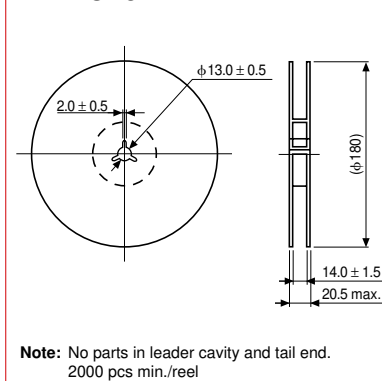

* CFEC also available with center frequency of 10.75 or 10.7 MHz.

PIEZO FILTERS CERAMIC DISCRIMINATORS FOR FM RECEIVER

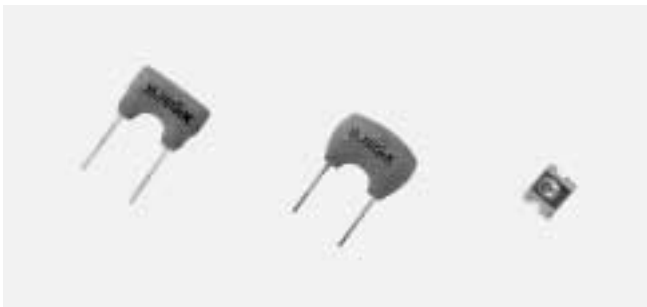

The CDA 10.7 line of ceramic discriminators are resonant devices that offer adjustment free audio detection in both wide and narrow bandwidths. These IC dependent devices utilize FM specific detection methods to convert changes in frequency into an intelligible audio signal.

LEADED CERAMIC DISCRIMINATORS

Part Number	IC Mfg.	IC Number	Part Number	IC Mfg.	IC Number
CDA10.7MG1-A	Sony	CX-20029/CX-20111	CDA10.7MG52-A	Motorola	MC13173
CDA10.7MG2-A	Sony	CX-831	CDA10.7MG53-A	Matsushita	AN7232
CDA10.7MG4-A	Rohm	BA4234L	CDA10.7MG54-A	Sony	CXA1376AM
CDA10.7MG6-A	Toshiba	TA7640AP	CDA10.7MG55-A	Philips	TEA5712T
CDA10.7MG7-A	Sanyo	LA1260	CDA10.7MG56-A	NEC	uPC1391H
CDA10.7MG8-A	Toshiba	TA7303P	CDA10.7MG57-A	Toshiba	TA2057
CDA10.7MG9-A	Toshiba	TA7130P	CDA10.7MG58-A	Toshiba	TA2046
CDA10.7MG12-A	Sony	CXA1030P	CDA10.7MG59-A	Samsung	KA2244
CDA10.7MG13-A	Matsushita	AN7007SU	CDA10.7MG60-A	Rohm	BA1448/1449
CDA10.7MG14A-A	Matsushita	AN7006S	CDA10.7MG61-A	Philips	TEA5762
CDA10.7MG15-A	Sanyo	LA1816	CDA10.7MG62-A	Toko	TK14581
CDA10.7MG16-A	Toshiba	TA8122AN	CDA10.7MG63-A	Samsung	KA2292
CDA10.7MG17-A	Philips	TEA5591	CDA10.7MG64-A	Samsung	KA2295
CDA10.7MG18-A	Toshiba	TA8132N	CDA10.7MG65-A	Samsung	KA2298
CDA10.7MG19-A	Rohm	BA1440	CDA10.7MG66-A	Rohm	BA4110
CDA10.7MG20-A	Signetics	NE604	CDA10.7MG67-A	Rohm	BA4240L
CDA10.7MG21-A	Signetics	TBA229-2	CDA10.7MG68-A	Sony	CXA1991N
CDA10.7MG22-A	Sanyo	LA1810	CDA10.7MG69-A	Sony	CXA1538
CDA10.7MG23-A	Sanyo	LA7770	CDA10.7MG70-A	Sanyo	LA1150
CDA10.7MG24-A	Philips	TDA2557	CDA10.7MG71-A	Toshiba	TA7765AF
CDA10.7MG25V-A	Telefunken	U829B	CDA10.7MG72-A	Toshiba	TA31161
CDA10.7MG26-A	Sanyo	LA1805	CDA10.7MG74-A	Sanyo	LA1838
CDA10.7MG27-A	Sony	CXA1238	CDA10.7MG75-A	Sony	CXA1611
CDA10.7MG28-A	Telefunken	U2501B	CDA10.7MG76-A	Sony	CXA3067M
CDA10.7MG29-A	Signetics	TBA120U	CDA10.7MG77-A	Toshiba	TA2111
CDA10.7MG30-A	Philips	TE5592	CDA10.7MG82-A	Toshiba	TA2099
CDA10.7MG31-A	Toshiba	TA2003	CDA10.7MG83-A	Sanyo	LA1827
CDA10.7MG32-A	Sony	CXA1343M	CDA10.7MG84-A	Rohm	BH4126FV
CDA10.7MG33-A	Toshiba	TA2007	CDA10.7MG85-A	Philips	SA639
CDA10.7MG34V-A	Telefunken	U4490B	CDA10.7MG86-A	Sanyo	LA1833
CDA10.7MG35-A	Philips	TEA5594	CDA10.7MG87-A	Motorola	MC3363
CDA10.7MG36-A	Toshiba	TA2029	CDA10.7MG88-A	Toshiba	TA8721ASN
CDA10.7MG37-A	Sanyo	LA1830	CDA10.7MC1-A	Sony	CX-2009T/CXA1019M
CDA10.7MG39-A	Toshiba	TA8186	CDA10.7MC2-A	Toshiba	TA7687P/F
CDA10.7MG40-A	Philips	TEA5710	CDA10.7MC3-A	Matsushita	AN7220A
CDA10.7MG41-A	Rohm	BA4220	CDA10.7MC4A-A	Motorola	MC3356P
CDA10.7MG42-A	Signetics	SA605	CDA10.7MC5A-A	Sanyo	LA7770
CDA10.7MG43-A	Sanyo	LA1831	CDA10.7MC6-A	Philips	TEA5591
CDA10.7MG45-A	Toshiba	TA2008	CDA10.7MC10-A	Philips	TEA5594
CDA10.7MG46-A	Sanyo	LA1832	CDA10.7MC19-A	Rohm	BA1440
CDA10.7MG47A-A	Signetics	SA626	CDA10.7MC30-A	Philips	TEA5592
CDA10.7MG48-A	Sanyo	LA1835	CDA10.7MC40-A	Philips	TEA5710
CDA10.7MG49-A	Motorola	MC13156	CDA10.7MC43-A	Sanyo	LA1831
CDA10.7MG50-A	Toshiba	TA2022	CDA10.7MC55-A	Philips	TEA5712T/N2
CDA10.7MG51-A	Siemens	TDA1576T			

Note: The -A suffix designates 10.7MHz center frequency with ± 30 kHz tolerance. The -Z suffix designates a 10.7MHz center frequency with a ± 90 kHz tolerance and is also available. See page 447.

PIEZO FILTERS
CERAMIC DISCRIMINATORS
FOR FM DEMODULATION RECEIVERS

SURFACE MOUNT CERAMIC DISCRIMINATORS

Part Number	IC Mfg.	IC Number
CDACV10.7MC1-A-TC	Sony	CX-20091
CDACV10.7MG1-A-TC	Sony	CX-20029
CDACV10.7MG16F-A-TC	Toshiba	TA8122AF
CDACV10.7MG18-A-TC	Toshiba	TA8132F
CDACV10.7MC40-A-TC	Philips	TEA5710
CDACV10.7MG50-A-TC	Toshiba	TA2022
CDACV10.7MG51-A-TC	Siemens	TDA1576T
CDACV10.7MG53-A-TC	National	AN7232
CDACV10.7MG54-A-TC	Sony	CXA1376
CDACV10.7MG69-A-TC	Sony	CXA1538N

LEADED DIMENSIONS: mm
CDA TYPE

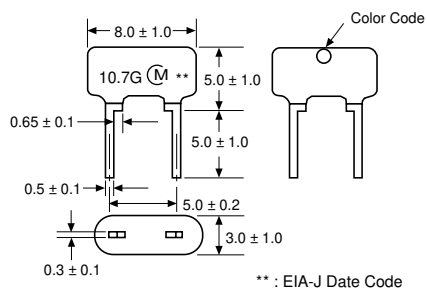

TYPICAL CIRCUIT

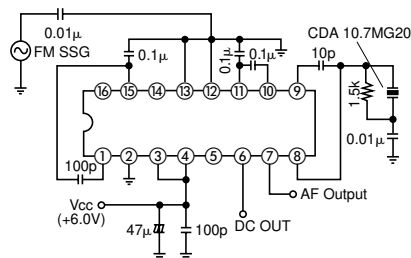

SURFACE MOUNT DIMENSIONS: mm
CDACV TYPE

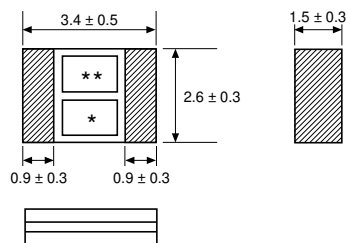

RECOMMENDABLE LAND PATTERN: mm

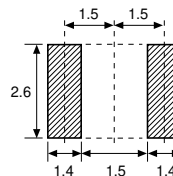

PIEZO FILTERS
 CERAMIC FILTERS
 HIGHLY ACCURATE TV/VCR TYPE

SFSH 4.5–6.5MHz



The SFSH lines of ceramic filters are high quality devices designed to address the TV/VCR/CATV/DBS markets. The SFSH lines are utilized as IF filters in virtually every type of technology currently used in the television industry.

SPECIFICATIONS

SFSH 4.5–6.5MHz

Part Number	3dB Bandwidth (kHz) min.	20dB Bandwidth (kHz) max.	Insertion Loss (dB) max.	Spurious Response (dB) min.	Input/Output Impedance (Ohms)
SFSH4.5MCB	±60 (±110)	600 (470)	6 (3.2)	30 (0 ~ 4.5MHz)	1k
SFSH5.5MCB	±60 (±115)	600 (500)	6 (3.6)	30 (0 ~ 5.5MHz)	600
SFSH6.0MCB	±60 (±110)	600 (500)	6 (4.0)	30 (0 ~ 6.0MHz)	470
SFSH6.5MCB	±70 (±110)	650 (530)	6 (3.6)	30 (0 ~ 6.5MHz)	470
SFSH4.5MDB	±70 (±130)	750 (520)	6 (3.0)	30 (0 ~ 4.5MHz)	1k
SFSH5.5MDB	±80 (±150)	750 (640)	6 (3.0)	30 (0 ~ 5.5MHz)	600
SFSH6.0MDB	±80 (±155)	750 (630)	6 (3.8)	30 (0 ~ 6.0MHz)	470
SFSH6.5MDB	±80 (±150)	800 (640)	6 (3.4)	30 (0 ~ 6.5MHz)	470
SFSH4.5MEB2	±125 (±180)	850 (740)	6 (3.5)	25 (0 ~ 4.5MHz)	1k

*5.5, 6.0, 6.5MHz types are also available

() Typ. value

DIMENSIONS: mm

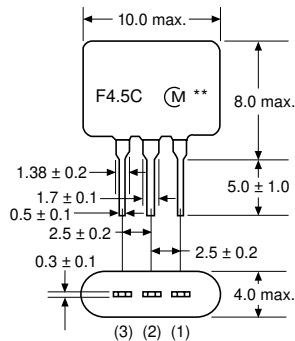

1=INPUT
 2=GROUND
 3=OUTPUT

** : EIA-J Date Code

CIRCUIT

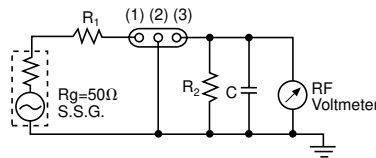

$R_g + R_1 = R_2 =$ Input/Output Impedance
 $C = 10\text{pF}$
 (including stray capacitance and input capacitance of RF Voltmeter)

1=INPUT
 2=GROUND
 3=OUTPUT

CHARACTERISTICS (Typ.)

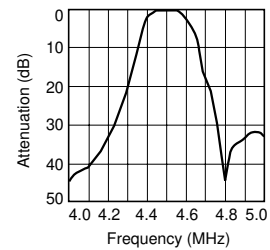

PIEZO FILTERS CERAMIC TRAPS HIGH ATTENUATION

TPS MJ/MB 4.5–6.5MHz



The TPS MJ/MB lines of ceramic traps are band reject filters used for video and sound IF attenuation. The 2 terminal TPS MJ Series can be used to attenuate either the sound signal in B/W receivers or the chroma signal in video. The 3 terminal TPS MB Series contains 2 trap elements on one substrate for additional attenuation. This line of traps can be used in the sound IF of CATV/VCR receivers.

SPECIFICATIONS

TPS MJ 4.5–6.5MHz

Part Number	Nominal Center Frequency (fn)	Attenuation at fn (dB) min.	20dB Attenuation Bandwidth (kHz) min.	Spurious Response (0 to fn) (dB) max.
★TPS3.58MJ	3.58MHz	20 (27)	20 (30)	0.5 (0)
TPS4.43MJ	4.43MHz	20 (30)	40 (50)	0.5 (0)
★TPS4.5MJ	4.5MHz	20 (30)	30 (50)	0.5 (0)
★TPS5.5MJ	5.5MHz	20 (30)	30 (60)	0.5 (0)
★TPS6.0MJ	6.0MHz	20 (30)	40 (70)	0.5 (0)
TPS6.5MJ	6.5MHz	20 (30)	40 (90)	0.5 (0)

() Typ. value

DIMENSIONS: mm

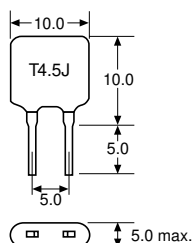

CIRCUIT

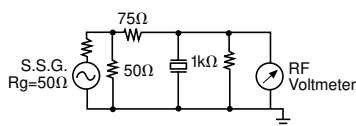

CHARACTERISTICS

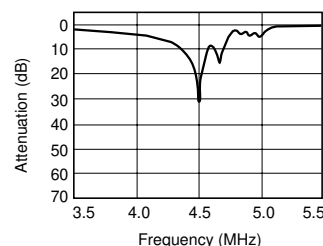

SPECIFICATIONS

TPS MB 4.5–6.5 MHz

Part Number	Nominal Center Frequency (fn)	Attenuation at fn (dB) min.	30dB Attenuation Bandwidth (kHz) min.	Spurious Response (0 to fn) (dB) max.
★TPS4.5MB2	4.5MHz	35 (45)	50 (80)	0.5 (0)
★TPS5.5MB	5.5MHz	35 (45)	70 (120)	0.5 (0)
★TPS6.0MB	6.0MHz	35 (45)	70 (120)	0.5 (0)
★TPS6.5MB	6.5MHz	35 (45)	70 (120)	0.5 (0)

The level at 1 MHz shall be made for a reference (0dB)
Other frequencies (3.58, 4.43 MHz) are also available.

() Typ. value

DIMENSIONS: mm

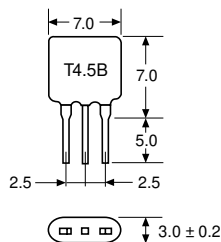

CIRCUIT

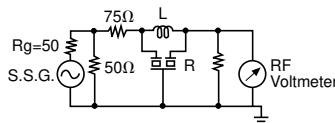

	L	R
MB2	8.2μH	2.2kΩ
Other	15μH	1.0kΩ

CHARACTERISTICS

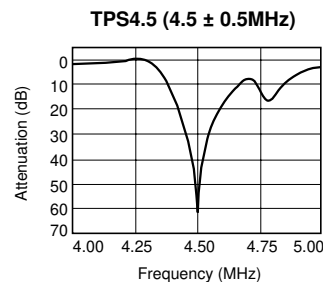

★ Available as standard through authorized Murata Electronics Distributors.

PIEZO FILTERS CERAMIC DISCRIMINATORS FOR QUADRATURE DETECTION

CDA MC/ME 4.5–6.5MHz



The CDA MC/ME lines of ceramic discriminators are IC dependent devices used in the recovery of audio signals. The CDA MC discriminators have three terminals while the CDA ME discriminators are 2 terminal devices.

MATCHING IC

CDA MC 4.5–6.5MHz

Part Number	IC	Part Number	IC	Part Number	IC
CDA□MC10	TBA120T	CDA□MC22	M51354AP	CDA□MC30	M51348FP
CDA□MC15	TA7146P	CDA□MC23	M51316P	CDA□MC31	TDA4282T
CDA□MC16	TDA4940	CDA□MC24B	LA7520	CDA□MC32	LA7522
CDA□MC17	TDA4280	CDA□MC25	LA7521	CDA□MC33	μPC1416G
CDA□MC18	HA11229	CDA□MC26	LA7530 (N)	CDA□MC34	TBA130-2
CDA□MC19	μPC1391H	CDA□MC27	μPC1411CA	CDA□MC35	M51345FP
CDA□MC20	μPC1382C	CDA□MC28	M51316BP		
CDA□MC21	μPC1383C	CDA□MC29	M51365SP		

□ Indicates frequency 4.5, 5.5, 5.74, 6.0, 6.5 MHz are available. Note that part numbers, circuits and ratings vary according to the IC used at detector process.

DIMENSIONS: mm	CIRCUIT	RECOVERED AUDIO CHARACTERISTICS
<p>○ : EIA-J Date Code</p>	<p>CDA 4.5 MC20</p> <p>(1)=INPUT (2)=GROUND (3)=OUTPUT</p>	<p>CDA 4.5 MC20</p> <p>Test Conditions= 100 dBV 400 Hz₂ ± 7.5kHz₂ Dev.</p>

MATCHING IC

CDA ME 4.5–6.5MHz

Part Number	IC	Part Number	IC	Part Number	IC
CDA□ME1	CX-20014	CDA□ME8	TBA129	CDA□ME23	M51496P
CDA□ME2	AN5135	CDA□ME10	TDA2546A	CDA□ME27	LA7650
CDA□ME3	TA7678AP	CDA□ME19	M51346BP	CDA□ME30	CXA1110AS
CDA□ME5	AN5135NK	CDA□ME20	LA7550	CDA□ME34	TA8680N
CDA□ME6	M51346AP	CDA□ME21	LA7545	CDA□ME35	LA7680
CDA□ME7	TDA4503	CDA□ME22	TDA2556	CDA□ME37	TA8691N

□ Indicates frequency 4.5, 5.5, 5.74, 6.0, 6.5 MHz are available. Note that part numbers, circuits and ratings vary according to the IC used at detector process.

DIMENSIONS: mm	CIRCUIT
<p>○ : EIA-J Date Code</p>	<p>CDA 4.5 ME20</p> <p>Voltmeter Recovered Audio Signal</p>

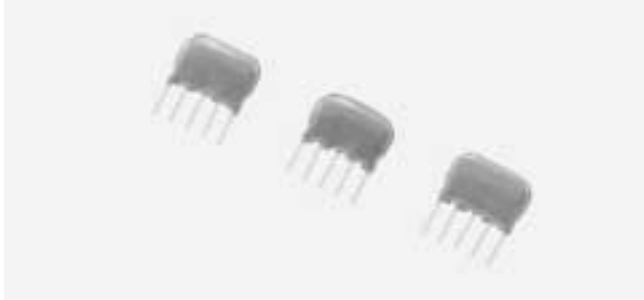

This series of saw filters is designed for TV/VCR applications. These filters are capable of passing 1) SIF and PIF, 2) SIF or 3) PIF. Saw filters are made up of zinc oxide on a glass substrate. Murata provides saw filters for a variety of television standards worldwide.

SPECIFICATIONS

SAF MHz

Part Number	Insertion Loss (dB) max.	Picture Carrier (dB) max.	Chroma Carrier (dB) min.	Attenuation (dB) max. at fs-0.3MHz	Attenuation (dB) max. at fs+0.3MHz	Adjacent Sound Carrier (dB) min.	Adjacent Picture Carrier (dB) min.	Spurious Response (dB) min.	Spurious Response (dB) min.	Temperature Coefficient (ppm/°C)
SAF54MC200Z	16(13)	40 min.	17	3	3	40	37	28 (0~52.75MHz)	30 (56.75~70MHz)	-28 ± 20
SAF41MC200Z	17(14)	40 min.	17	3	3	40	37	28 (0~39.75MHz)	30 (43.75~56MHz)	-28 ± 20
SAF39.2MC70Z	19(14)	40 min.	35	6	6	40	30	30 (28~31.2MHz)	30 (40.7~45MHz)	-10 ± 20
SAF33.4MC200Z	20(18)	40 min.	20	4	4	40	35	30 (0~31.9MHz)	30 (40.4~47MHz)	-10 ± 20
SAF54MD200Z	20(17)	within ±3	20	fs~0.2MHz 3	fs~0.2MHz 3	35	30	30 (0~70MHz)	15 ¹ (55.5~57.5MHz)	-28 ± 20
SAF41MD200Z	17(14)	within ±3	20	fs~0.2MHz 3	fs~0.2MHz 3	35	35	30 (0~55MHz)	15 ¹ (42.5~44.5MHz)	-28 ± 20
SAF33.4MD200Z	20.5(16)	within ±3	20	fs~0.2MHz 3	fs~0.2MHz 3	35	35	30 (0~50MHz)	15 ¹ (34.67~37.7MHz)	-10 ± 20
SAF33.0MDA70Z	26(23)	5.0 ± 3.0	12	fs~0.2MHz 3	fs~0.2MHz 3	26	20	15 (0~39.5MHz)	8 ¹ (34.67~37.7MHz)	-10 ± 20
SAF32.9MDE70Z	25(23)	4.3 ± 3.0	15	fs~0.2MHz 3	fs~0.2MHz 3	35	25	22 (0~31.5MHz)	10 ¹ (35.27~38MHz)	-10 ± 20
SAF31.4MD70Z	28(26)	within ±3	15	fs~0.2MHz 3	fs~0.2MHz 3	35	35	30 ¹ (0~45MHz)	15 ¹ (32.645~35.675MHz)	-10 ± 20

DIMENSIONS: mm

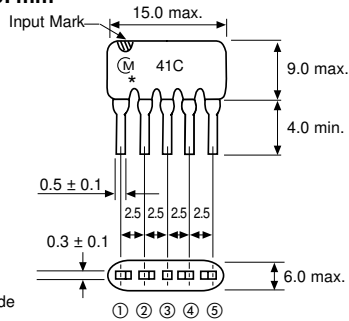

SAF-200Z

DIMENSIONS: mm

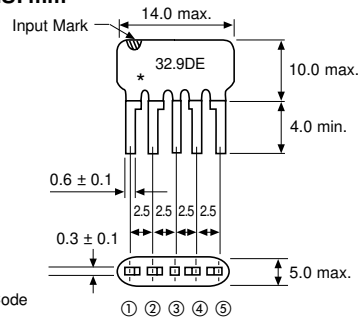

SAF-70Z

• SAF54MC200Z, SAF41MC200Z and SAF33.4MC200Z are for Split Carrier System.
• SAF54MD200Z, SAF41MD200Z, SAF33.4MD200Z and SAF31.4MD70Z are for Quasi-Parallel System.

• SAF33.0MDA70Z is for Multi-Sound TV in Northern Europe. (): Typ. values
• SAF32.9MDE70Z is for Multi-Sound TV in U.K.
• 0dB level should be at fs.

¹Minimum attenuation between picture carrier and sound carrier

FREQUENCY CHARACTERISTICS

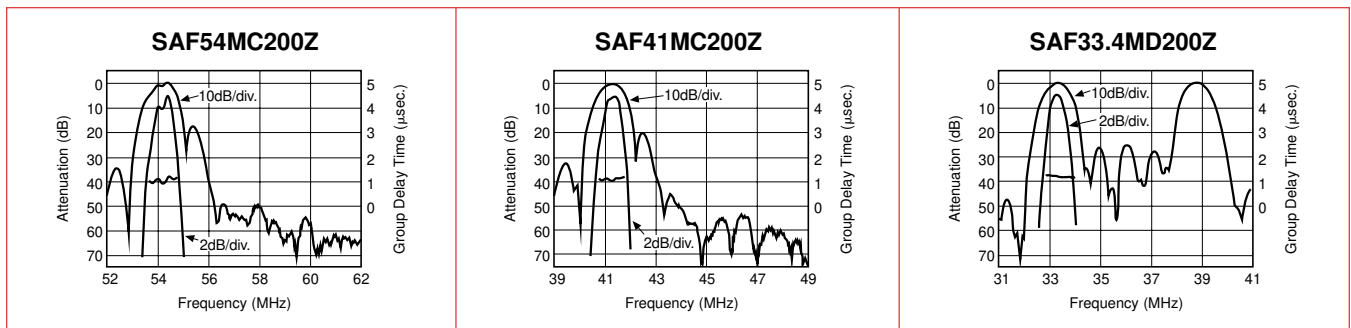

PIEZO FILTERS

SAW FILTERS FOR AUDIO VISUAL EQUIPMENT

MULTI TV/VCR SIF

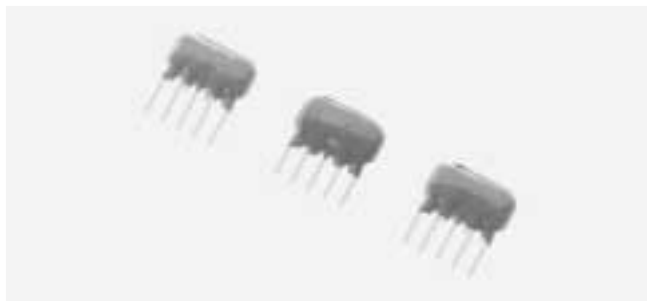

This series of saw filters is designed for TV/VCR applications. These filters are capable of passing 1) SIF and PIF, 2) SIF or 3) PIF. Saw filters are made up of zinc oxide on a glass substrate. Murata provides saw filters for a variety of television standards worldwide.

SPECIFICATIONS

SAF

Part Number	Insertion Loss (dB) max.	Picture Carrier (dB) max.	Chroma Carrier (dB) min.	Attenuation (dB) max. at fs-0.3MHz	Sound 1 (fs1) Carrier (dB) max.	Sound 2 (fs2) Carrier (dB) max.	Attenuation (dB) max. at fs+0.3MHz	Adjacent Sound Carrier (dB) min.	Adjacent Picture Carrier (dB) min.	Spurious Response (dB) min.	Spurious Response (dB) min.	Temperature Coefficient (ppm/°C)
SAF32.0MCA70Z	26(23)	35(55)	25(35)	6	3	3	6	40(55)	35(50)	30 (0~30MHz)	22 (33.57~42MHz)	-10 ± 20
SAF32.9MCA70Z	25(22)	35(53)	25(34)	6	3	3	6	40(55)	35(43)	30 (0~30.9MHz)	22 (34.47~42MHz)	-10 ± 20
SAF33.4MCB200Z	29(26)	30(47)	14(30)	6	3	3	6	30(46)	35(50)	25 (0~30.9MHz)	25 (40.4~46.0MHz)	-10 ± 20
SAF33.4MCD70Z	29(26)	30(49)	20(37)	2 [32.348 MHz]	2	2.5	8	30(50)	28(42)	25 (0~30.9MHz)	30 (40.4~46.0MHz)	-10 ± 20

DIMENSIONS: mm

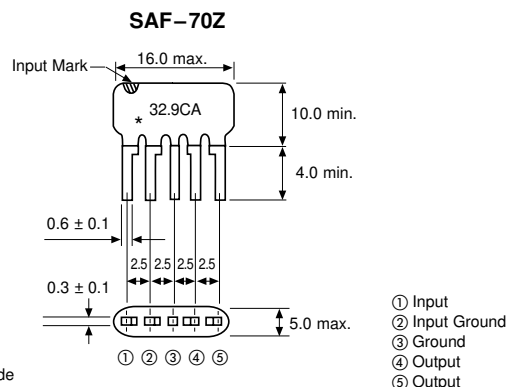
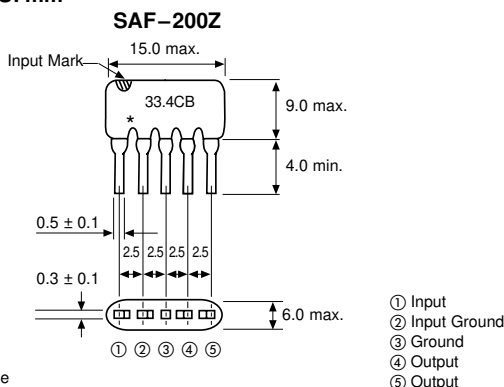

- Since the insertion loss of surface acoustic wave filters varies with the matching state, the values of insertion loss in the table are not always in conformity with insertion loss of the actual circuit. (): Typ. values
- fp—picture carrier, fc—chroma carrier, fs—sound carrier, fas—adjacent sound carrier, fap—adjacent picture carrier.

FREQUENCY CHARACTERISTICS

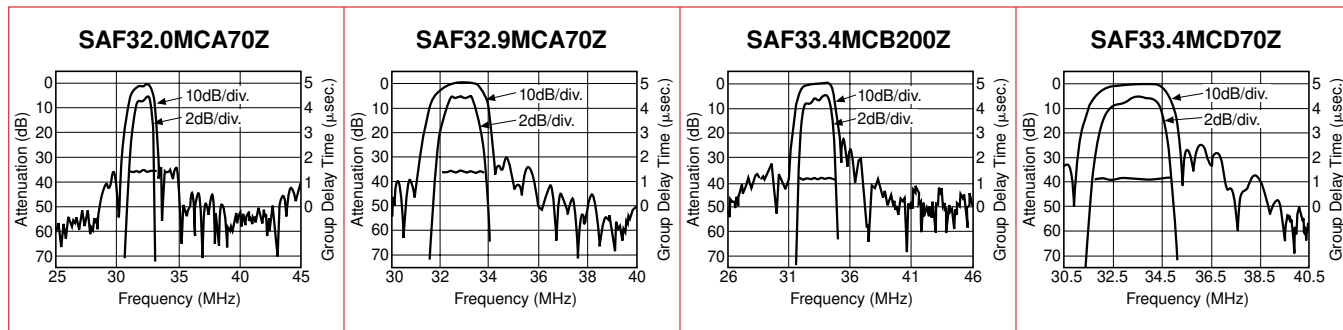

PIEZO FILTERS

SAW FILTERS FOR AUDIO VISUAL EQUIPMENT

MULTI TV/VCR/VIF



This series of saw filters is designed for TV/VCR applications. These filters are capable of passing 1) SIF and PIF, 2) SIF or 3) PIF. Saw filters are made up of zinc oxide on a glass substrate. Murata provides saw filters for a variety of television standards worldwide.

SPECIFICATIONS

SAF

Part Number	Insertion Loss (dB) max.	Picture Carrier (dB)	Chroma Carrier (dB)	Sound 1 Carrier (dB)	Sound 2 Carrier (dB)	Sound 3 Carrier (dB)	Adjacent Sound Carrier (dB) min.	Adjacent Picture Carrier (dB) min.	Spurious Response (dB) min.	Temperature Coefficient (ppm/°C)	System
SAF38.0MZE210Z	27(22)	4.8 ± 1.2	3.8 ± 1.3	17.5 ± 3.0	—	17.0 ± 3.0	40(53)	40(53)	30(43)	-10 ± 20	D/K/B/G/I
SAF38.0MZJ80Z	29(26)	5.1 ± 1.2	4.1 ± 1.5	22.0 ± 3.0	—	19.5 ± 3.0	40(56)	40(55)	30(40)	-10 ± 20	D/K/B/G/I
SAF38.9MX200Z	26(23)	5.0 ± 1.2	3.4 ± 1.0	18.0 ± 3.0	15.0 ± 3.0	22.0 ± 4.0	40(48)	35(41)	30(38)	-10 ± 20	B/G/I/D/K
SAF38.9MZA80Z	25(22)	4.5 ± 1.3	4.5 ± 1.3	16.5 ± 3.0	15.0 ± 3.0	20.0 ± 3.0	45(53)	40(58)	30(46)	-10 ± 20	B/G/I/D/K
SAF38.9MZC200Z	25.5(22)	3.7 ± 1.3	4.3 ± 1.3	15.5 ± 3.0	—	16.5 ± 3.0	40(50)	40(47)	30(36)	-10 ± 20	B/G/I/D/K

DIMENSIONS: mm

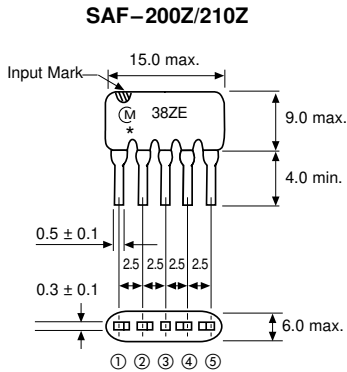

- ① Input
- ② Input Ground
- ③ Ground
- ④ Output
- ⑤ Output

* : EIA-J Date Code

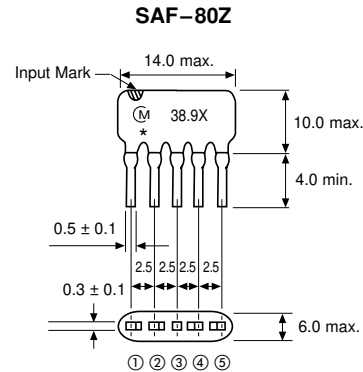

- ① Input
- ② Input Ground
- ③ Ground
- ④ Output
- ⑤ Output

* : EIA-J Date Code

() : Typ. values

FREQUENCY CHARACTERISTICS

SAF38.0MZE210Z

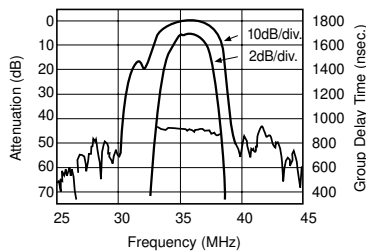

SAF38.9MX200Z

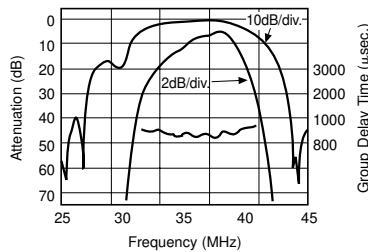

SAF38.9MZA80Z

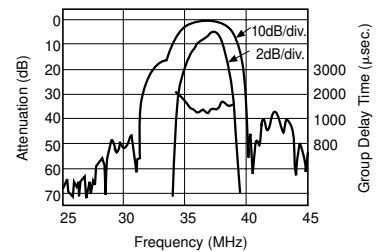

PIEZO FILTERS SAW FILTERS FOR AUDIO VISUAL EQUIPMENT

SAF Series

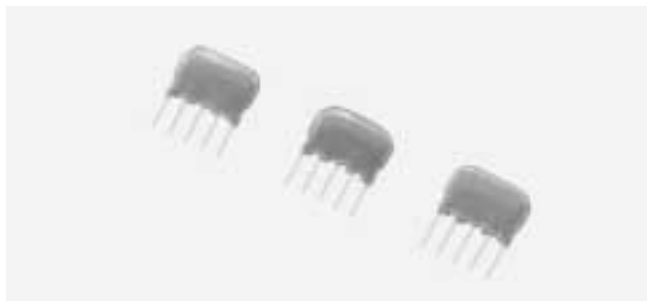

This series of saw filters is designed for TV/VCR applications. These filters are capable of passing 1) SIF and PIF, 2) SIF or 3) PIF. Saw filters are made up of zinc oxide on a glass substrate. Murata provides saw filters for a variety of television standards worldwide.

SPECIFICATIONS

SAF

Part Number	Insertion Loss (dB) max.	Picture Carrier (dB)	Chroma Carrier (dB)	Sound Carrier (dB)	Adjacent Sound Carrier (dB) min.	Attenuation at fap +1.0MHz (dB) min.	Attenuation at fap -0.5MHz (dB) min.	Adjacent Picture Carrier (dB) min.	Attenuation at fap -0.5 MHz (dB) min.	Spurious Response (dB) min.	Temperature Coefficient (ppm/°C)
SAF38.9MZ215Z	24.0(19)	5.0 ± 1.2	5.8 ± 1.5	19.0 ± 2	44(56)	42(52)	—	45(50)	—	36	-10 ± 20
SAF38.9MZR80Z	24.0(22)	4.5 ± 1.2	4.5 ± 1.5	22.0 ± 3	40(48)	38(48)	35(45)	40(48)	37(50)	30	-10 ± 20
SAF38.9MZW210Z	22.5(20)	4.5 ± 1.2	3.1 ± 1.0	17.5 ± 3	43(54)	38(52)	38(42)	36(42)	38(42)	33	-10 ± 20

DIMENSIONS: mm SAF-210Z/215Z

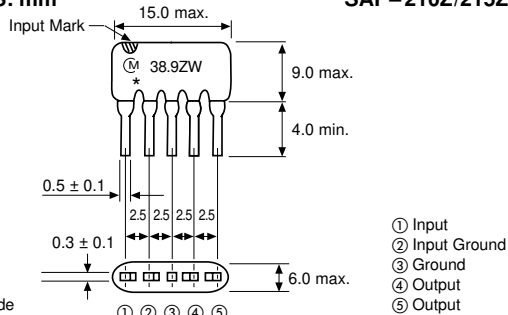

* : EIA-J Date Code

DIMENSIONS: mm SAF-80Z

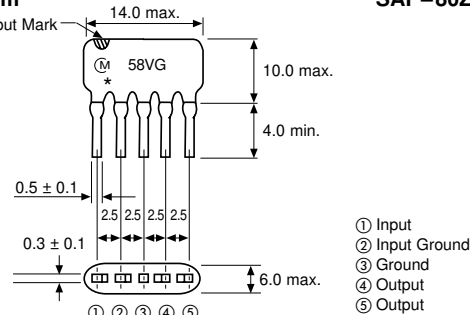

* : EIA-J Date Code

FREQUENCY CHARACTERISTICS

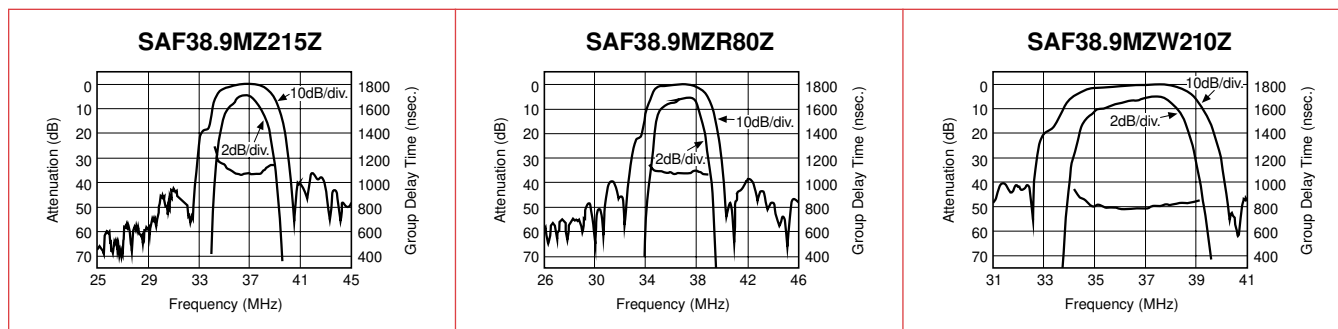

SPECIFICATIONS

SAF

Part Number	Insertion Loss (dB) max.	Picture Carrier (dB)	Chroma Carrier (dB)	Sound Carrier (dB)	Attenuation at fap -4.0MHz (dB) max.	Adjacent Sound Carrier (dB) min.	Adjacent Picture Carrier (dB) min.	Spurious Response (dB) min.	Temperature Coefficient (ppm/°C)
SAF58MVG80Z	23(20)	4.8 ± 1.2	1.0	20	5.0(2.0)	40(53)	40(58)	30	-28 ± 20
SAF45MVE80Z	23(20)	5.0 ± 1.2	1.2	20	5.5(2.7)	40(48)	40(53)	28	-28 ± 20

DIMENSIONS: mm

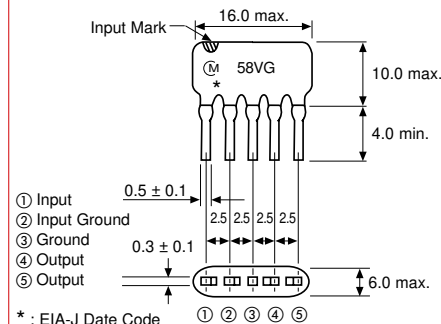

* : EIA-J Date Code

FREQUENCY CHARACTERISTICS

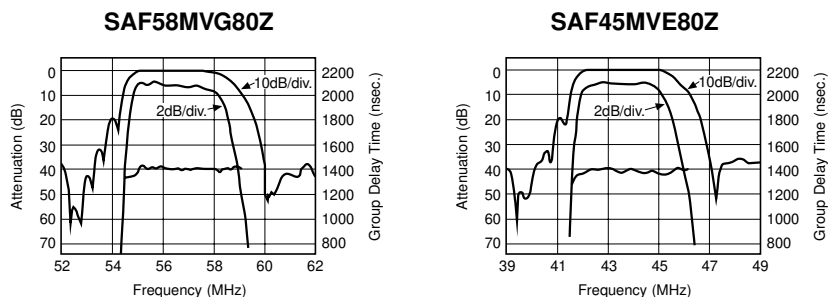

PIEZO FILTERS

SAW FILTERS FOR AUDIO VISUAL EQUIPMENT

COLOR TV VIF/VCR



SAF Series



This series of saw filters are designed for TV/VCR applications. These filters are capable of passing SIF, PIF, SIF or PIF. Saw filters are made up of zinc oxide on a glass substrate. Murata provides saw filters for a variety of television standards world wide.

SPECIFICATIONS

SAF

Part Number	Insertion Loss (dB) max.	Picture Carrier (dB)	Chroma Carrier (dB)	Sound Carrier (dB)	Adjacent Sound Carrier (dB) min.	Adjacent Picture Carrier (dB) min.	Spurious Response (dB) min.	Temperature Coefficient (ppm/°C)
SAF58MH210Z	21(17)	4.2 ± 1.2	4.2 ± 1.5	20 ± 3	40(57)	40(53)	30	-28 ± 20
SAF45MA210Z	21(18)	4.0 ± 1.2	4.5 ± 1.5	18 ± 3	40(54)	40(47)	30	-28 ± 20
SAF39.5MZ210Z	25(22)	5.0 ± 1.2	4.5 ± 1.5	20 ± 3	40(52)	40(55)	30	-10 ± 20
SAF38.9MZ210Z	24(19)	5.0 ± 1.2	5.8 ± 1.5	20 ± 3	40(55)	40(47)	30	-10 ± 20
SAF38.0MZ210Z	27(25)	6.0 ± 1.5	6.6 ± 1.5	25 ± 3	40(48)	40(55)	30	-10 ± 20
SAF36.9MZ80Z	25(21)	5.0 ± 1.2	5.0 ± 1.5	20 ± 3	40(50)	40(53)	30	-10 ± 20
SAF32.7MZ80Z	25(22)	6.5 ± 1.5	1.0 ± 1.0	38 min.	40(48)	35(48)	30	-10 ± 20
SAF58MVB200Z	20(15)	4.5 ± 1.2	4.5 ± 1.5	25 min.	40(55)	40(57)	30	-28 ± 20
SAF45MVG200Z	21(19)	4.5 ± 1.2	4.5 ± 1.5	25 min.	40(55)	40(47)	29	-28 ± 20
SAF38.9MVB200Z	24(21)	4.5 ± 1.2	4.8 ± 1.5	25 min.	40(48)	40(55)	30	-10 ± 20

DIMENSIONS: mm

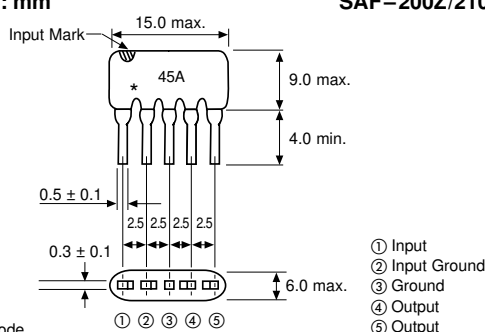

* : EIA-J Date Code

SAF-200Z/210Z

DIMENSIONS: mm

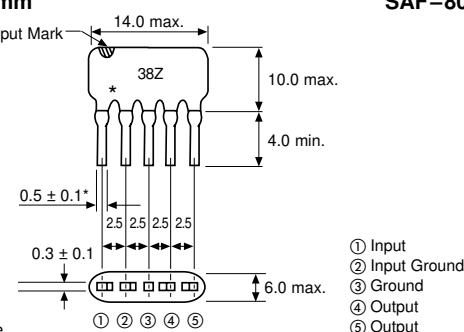

* : EIA-J Date Code

SAF-80Z

- SAF58MVB200Z, SAF45MVG200Z and SAF38.9MVB200Z are for picture IF filters in quasi-parallel or split carrier systems.
- Low-profile type 6.0mm (60Z) is also available.

(): Typ. values

FREQUENCY CHARACTERISTICS

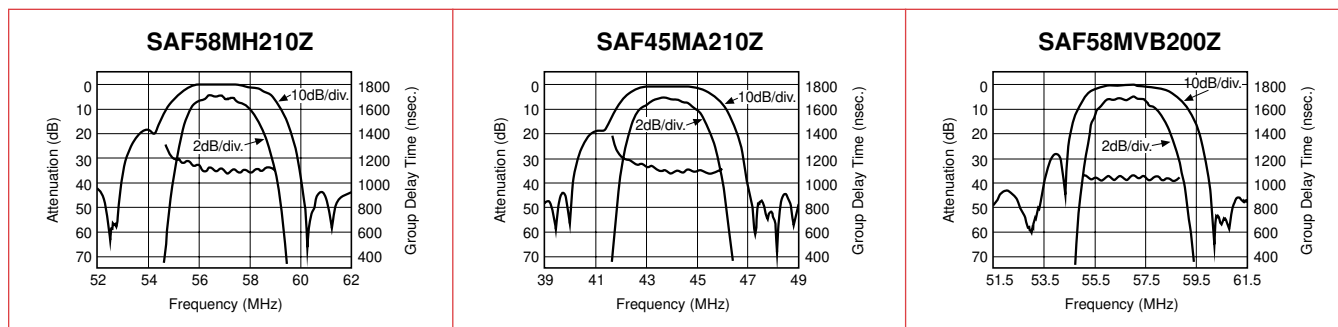

PIEZO FILTERS SAW FILTERS FOR SET TOP BOX (CATV)

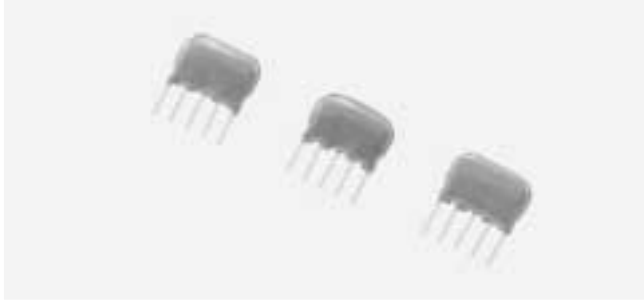

This series of saw filters is designed for TV/VCR applications. These filters are capable of passing 1) SIF and PIF, 2) SIF or 3) PIF. Saw filters are made up of zinc oxide on a glass substrate. Murata provides saw filters for a variety of television standards worldwide.

SPECIFICATIONS

SAF

Part Number	Insertion Loss (dB) max.	Flatness (dB) max.	Lower ch. Picture Carrier (dB) min.	Lower ch. Sound Carrier (dB) min.	Picture Carrier (dB)	Chroma Carrier (dB)	Sound Carrier (dB)	Upper ch. Picture Carrier (dB) min.	Spurious Response (dB) min.	Temperature Coefficient (ppm/°C)
SAF45MT210Z	23	2 ¹⁰	14	—	2 max.	2 max.	2 max.	30	27	-28 ± 20
SAF55MB70Z	21	2	35	8	0	0 ± 1	2 max.	35	26	-28 ± 20
SAF58MT71Z	22	2	14	8	2	2	2	30	27	-28 ± 20
SAF61MB210Z	20	1 ²	35	8	0	0 ± 1	2 max.	35	26 ⁶	-28 ± 20
SAF61MD210Z	23	2 ³	30 ⁴	8 ⁴	2 max. ⁴	2 max.	2 max.	14 ⁴	27	-28 ± 20
SAF61MZ72Z	22	—	30 ⁴	40 ⁴	5.5 ± 1.2 ⁴	5.0 ± 1.5 ⁴	20 ± 3 ⁴	40 ⁴	28	-28 ± 20
SAF67MB70Z	20	2	35	8	0	0 ± 1	2 max.	35	26	-28 ± 20

Note: SAF55MB70Z is full channel pass filter for channel 2. SAF61MB70Z is full channel pass filter for channel 3. SAF67MB70Z is full channel pass filter for channel 4. For channel 2 SAF59.8MA72Z, channel 3 SAF65.8MA72Z and channel 4 SAF71.8MA72Z is the Sound Intermediate Frequency (SIF).
 • SAF61MD70Z is a wide-band type. SAF61MZ72Z is for direct detection systems. * Reference Point. ²61.25 – 64.83MHz. ³61.25 – 65.75MHz. ⁴Reference level (0dB) is the peak value. ⁵50–55.25MHz 67.25–78MHz ⁶0–55.25MHz 67.25–80MHz ⁷0–55.25MHz 68.25–80MHz ⁸30: 0–59.75MHz 28: 67.25–80MHz ⁹41.25–45.75MHz

DIMENSIONS: mm

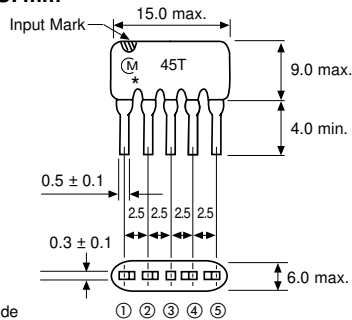

* : EIA-J Date Code

SAF-210Z

- ① Input
- ② Input Ground
- ③ Ground
- ④ Output
- ⑤ Output

DIMENSIONS: mm

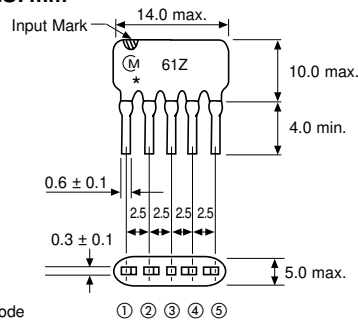

* : EIA-J Date Code

SAF-70Z

- ① Input
- ② Input Ground
- ③ Ground
- ④ Output
- ⑤ Output

FREQUENCY CHARACTERISTICS

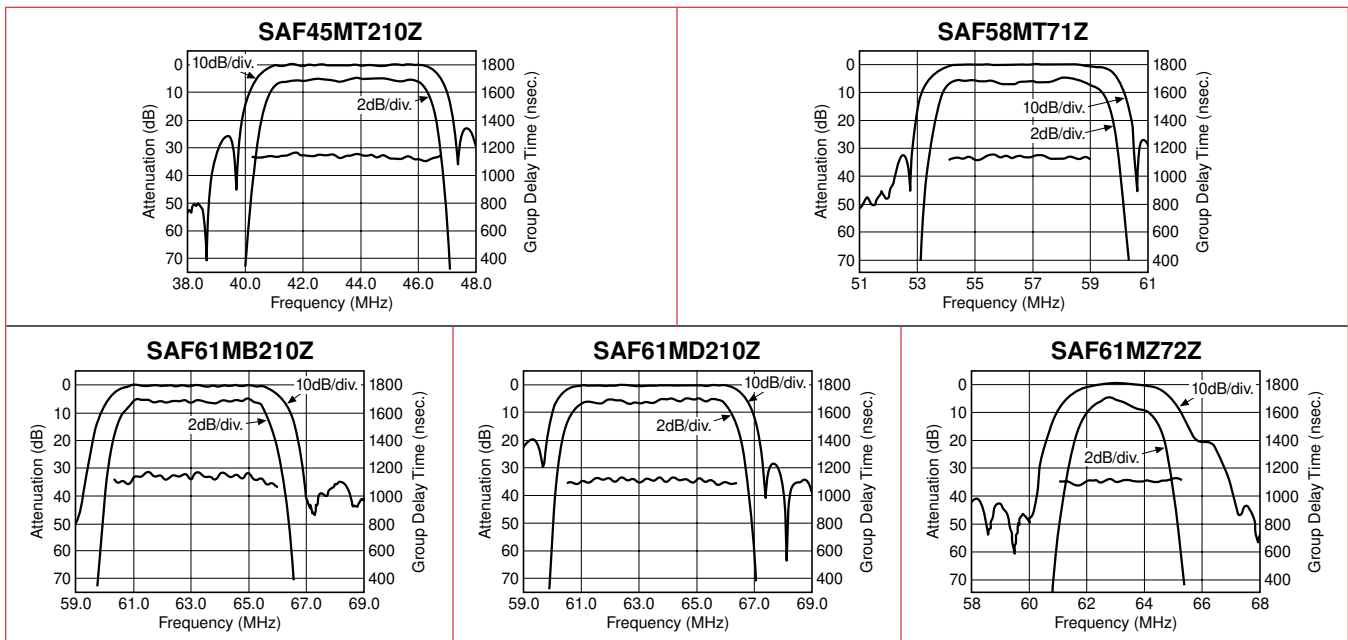

PIEZO FILTERS

PIEZO FILTERS SAW FILTERS FOR SET TOP BOX (CATV)

SAF Series

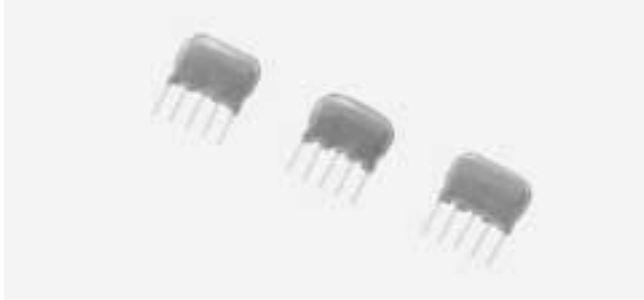

This series of saw filters is designed for TV/VCR applications. These filters are capable of passing 1) SIF and PIF, 2) SIF or 3) PIF. Saw filters are made up of zinc oxide on a glass substrate. Murata provides saw filters for a variety of television standards worldwide.

SPECIFICATIONS

SAF

Part Number	Insertion Loss (dB max.)	Picture Carrier (dB)	Attenuation (dB) at $f_s - 0.25\text{MHz}$	Attenuation (dB) at $f_s + 0.25\text{MHz}$	Upper ch. Picture Carrier (dB)	Spurious Response (dB) min.	Temperature Coefficient (ppm/°C)
SAF65.8MA72Z	18	—	3	3	—	20*	-28 ± 20
SAF41MCA70Z	17	(40)	($f_s - 0.2\text{MHz}$) 3.5	($f_s + 0.2\text{MHz}$) 3.5	(37)	30	-28 ± 20

* The level at sound carrier frequency (f_s) is to be the reference (0dB).

*0-64.7 MHz, 66.8-100MHz.

DIMENSIONS: mm

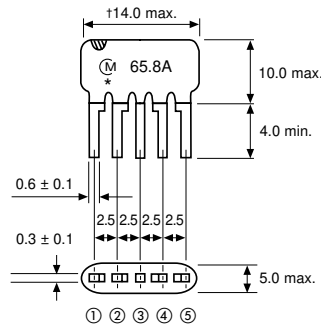

- ① Input
- ② Input Ground
- ③ Ground
- ④ Output
- ⑤ Output

* : EIA-J Date Code

†SAF41MCA70Z = 16.0 max.

FREQUENCY CHARACTERISTICS

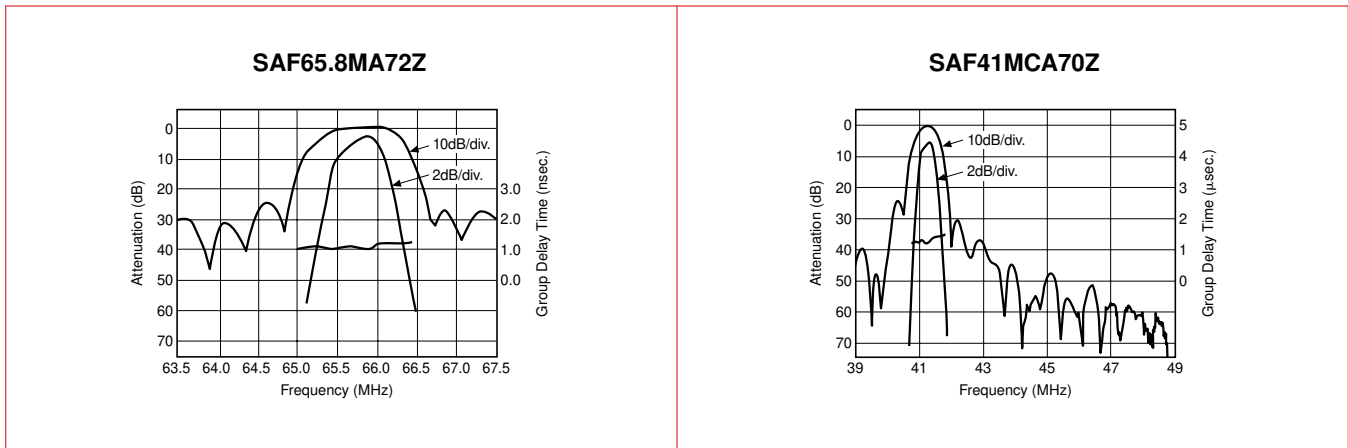

PIEZO FILTERS

SAW FILTERS FOR CABLE MODEM DTV/DIGITAL CATV

NEW

muRata
Innovator in Electronics

SAF Series



To meet the needs of the newest emerging technologies, Murata now offers a line of SAW filters designed for Digital Television, Digital Cable Television, and Cable Modem applications.

SPECIFICATIONS

SAF MHz

Part Number		SAF44MTC80ZL	SAF44.00MTD220ZL	SAF44.00MTE220ZL
Insertion Loss (at 44.00 MHz)		22.0dB	20.5dB	21.0dB
Amplitude Response dB	39.75MHz	35.0 min.	—	—
	40.00MHz	—	32.0 min.	32.0 min.
	40.50MHz	—	10.0 min.	7.0 min.
	41.00MHz	—	3.5 ± 1.5	1.5 ± 1.5
	41.31MHz	0.7 ± 1.3	—	—
	41.47MHz	—	0.0 ± 1.2	0.0 ± 1.2
	46.53MHz	—	0.0 ± 1.2	0.0 ± 1.2
	46.69MHz	1.5 ± 1.5	—	—
	47.00MHz	—	3.5 ± 1.5	2.0 ± 1.5
	47.25MHz	25.0 min.	—	—
47.50MHz	—	10.0 min.	8.0 min.	
48.00MHz	—	34.0 min.	30.0 min.	
Amplitude Ripple		1.0dB p-p (41.62 to 46.38MHz)	1.0dB p-p (41.00 to 47.00MHz)	1.0dB p-p (41.00 to 47.00MHz)
GDT Ripple		60 nsec. max. (41.62 to 46.38MHz)	60 nsec. p-p max. (41.00 to 47.00MHz)	60 nsec. p-p max. (41.00 to 47.00MHz)
Spurious Response (dB min.) (Reference Level at 44.00MHz)		30.00 (0.00 to 40.00MHz) 30.00 (48.00 to 55.00MHz)	30.0 (35.00 to 40.00MHz) 28.0 (48.00 to 55.00MHz)	28.00 (0.00 to 40.00MHz) 25.00 (48.00 to 55.00MHz)

DIMENSIONS: mm

SAF-80Z

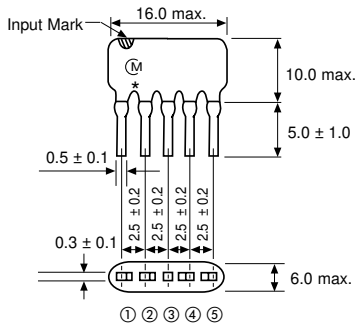

* : EIA-J Date Code

DIMENSIONS: mm

SAF-220Z

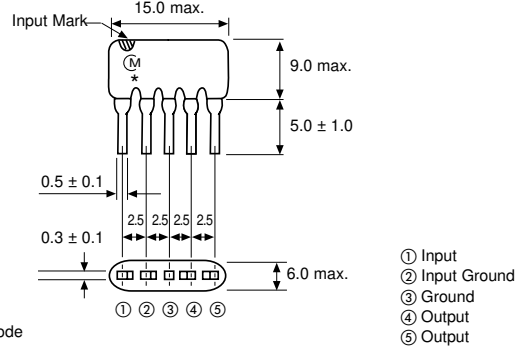

* : EIA-J Date Code

TEST CIRCUIT

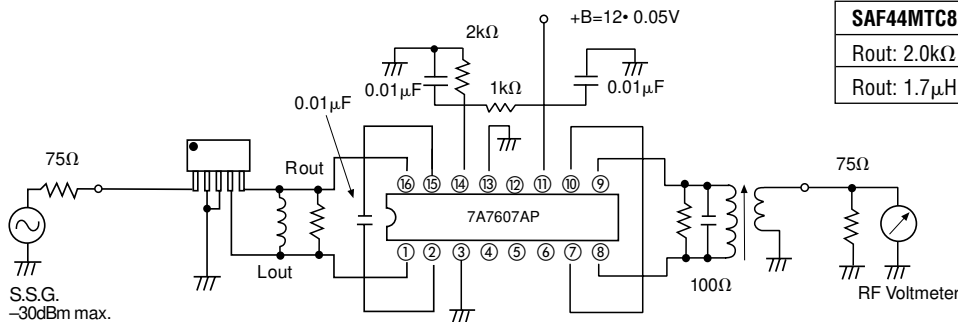

SAF44MTC80ZL	SAF44.00MTD(E)220ZL
Rout: 2.0kΩ	Rout: 3.0kΩ
Rout: 1.7μH	Lout: 1.55μH

PIEZO FILTERS

SAW FILTERS FOR AUDIO VISUAL EQUIPMENT

TAPING DIMENSIONS

SPECIFICATIONS

Item	Code	Part Number			
		SAF□M80Z-TF/SAF□M200Z-TF		SAF□M80Z-TF01/SAF□M200Z-TF01	
		Nominal Value	Allowable Value	Nominal Value	Allowable Value
Portion to cut in case of defect	L ₁	3	min.	3	min.
Pitch of component	P	25.4	±0.5	25.4	±0.5
Pitch of sprocket hole	P ₀	12.7	±0.2	12.7	±0.2
Feed hole position to SAW filter terminal	P ₁	3.85	±0.5	3.85	±0.5
Feed hole position to SAW filter terminal	P ₂	6.35	±0.5	6.35	±0.5
Terminal spacing ⁽¹⁾	F	5.0	+0.5 -0.2	5.0	+0.5 -0.2
Terminal spacing ⁽²⁾	F ₁	2.5	±0.2	2.5	±0.2
Deviation across tape	Δh	0	±1.0	0	±1.0
Deviation along tape, left or right	Δs	0	±1.0	0	±1.0
Carrier tape width	W	18.0	±0.5	18.0	±0.5
Hold-down tape width	W ₀	6.0	min.	6.0	min.
Position of sprocket hole	W ₁	9.0	±0.5	9.0	±0.5
Hold-down tape width	W ₂	0	±0.5	0	±0.5
Distance between reference and terminal	H ₀	16.0	±0.5	18.0	±0.5
Height of terminal stopper	H	19.25	±0.5	21.25	±0.5
Distance between reference and top	H ₁	32.0	max.	32.0	max.
Diameter of sprocket hole	D ₀	φ4.0	±0.2	φ4.0	±0.2
Total tape thickness	t	0.6	±0.2	0.6	±0.2

DIMENSIONS: mm

SAF□M200Z-TF01/SAF□M80Z-TF01

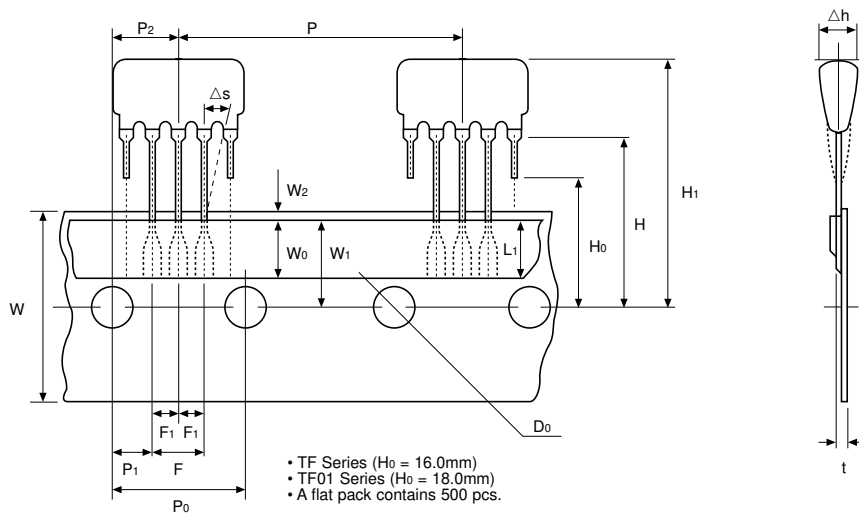

•The differences between TF and TF01 are only the dimensions of H_0 (16mm or 18mm) and H (19.25mm or 21.25mm).

PIEZO FILTERS HIGH FREQUENCY TRAP FOR TV/VCR APPLICATIONS

NEW

muRata

Innovator in Electronics

MKT Series



MKT is a high frequency trap for television or other similar systems.

SPECIFICATIONS

Part Number	Nominal Center Frequency (MHz)	10dB Band Width (kHz) min.	Ripple (dB) max.	*Attenuation (dB) max.
MKT47.3MA110P	47.25	65	1.0	2.0
MKT40.4MA110P	40.4	65	1.0	2.0
MKT31.9MA110P	31.9	65	1.0	2.0

DIMENSIONS: mm

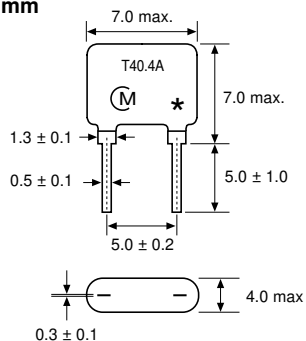

CIRCUIT

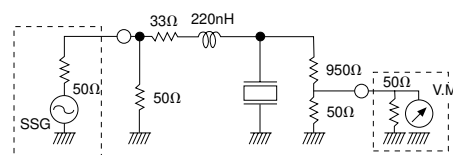

*Attenuation at fp

•Attenuation MKT40.4MA110P: 38.9MHz point, MKT31.9MA110P: 33.4MHz point.

•30.9MHz, 39.5MHz, 47.25MHz and 60.25MHz types are also available.

FREQUENCY CHARACTERISTICS

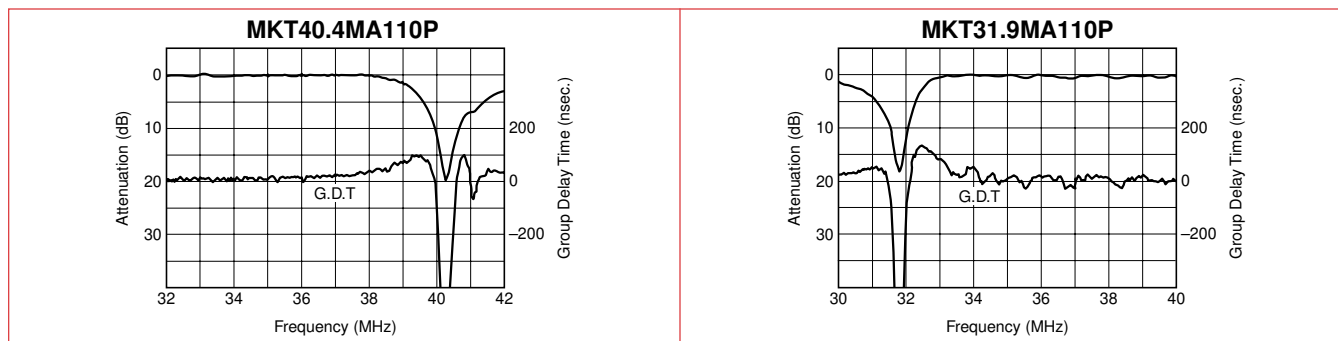

PART NUMBER LIST

Part Number	Nominal Center Frequency (MHz)	Picture Carrier (fp) (MHz)	System	Application	Matching Impedance (R/L) (Ohms/nH)
MKT30.0MA110P	30.0	38.0	B/G/I/D/K	fap	20/—
MKT32.0MA110P	32.0	38.0	M	fap	20/—
MKT39.5MA110P	39.5	38.0	B/G/I/D/K/M	fas	33/220
MKT30.9MA110P	30.9	38.9	I/D/K	fap	20/—
MKT31.9MA110P	31.9	38.9	B/G	fap	20/—
MKT40.4MA110P	40.4	38.9	B/G/I/D/K	fas	33/220
MKT31.5MA110P	31.5	39.5	I	fap	20/—
MKT41.5MA110P	41.5	39.5	I	fas	33/220
MKT31.2MA110P	31.2	32.7	L	fas	20/—
MKT40.7MA110P	40.7	32.7	L	fap	33/220
MKT39.8MA110P	39.75	45.75	M	fap	20/—
MKT47.3MA110P	47.25	45.75	M	fas	27/180
MKT52.8MA110P	52.75	58.75	M	fap	10/—
MKT60.3MA110P	60.25	58.75	M	fas	22/150

• Available frequency range: Center frequency 30 to 70MHz.

• Application fap: For adjacent picture frequency.

• Application fas: For adjacent sound frequency.

PIEZO FILTERS