

# MSG series

Rugged switch guards for switch series 12000 - 3500 - 600H - 6000



## DISTINCTIVE FEATURES

Robust

For harsh environments

Modern, patented design



## GENERAL SPECIFICATIONS

- APEM SAS patented design
- Operating temperature : -40 °C to +85 °C (-40 °F to +185 °F)
- Storage temperature : -55 °C to +85 °C (-67 °F to +185 °F)
- Salt spray : IEC 60068-2-11, test KA, 96 hours
- Mechanical life : 20,000 cycles
- Switch guards are designed to prevent accidental lever operation on switches with  $\varnothing$  11.9 (.468) or  $\varnothing$  12 (.472) threaded bushing and lever length 17.5 (.688) outside bushing.  
When the guard is raised, the lever can be operated freely.  
When the guard is fully depressed, the lever is reset/locked in a stable position.  
Note : For correct switch operation, the switch guard should be adjusted properly (see "Mounting" below).



## MATERIALS

- Support plate : black stainless steel
- Cap : thermoset

APEM products may be recycled at end-of-life for the re-claiming of valuable metal components.



## PANEL CUT-OUT

FOR BUSHING WITH KEYWAY

FOR FLATTED BUSHING

K

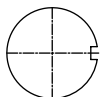

F

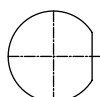

The company reserves the right to change specifications without notice.



# MSG series

Rugged switch guards for switch series 12000 - 3500 - 600H - 6000

## MOUNTING

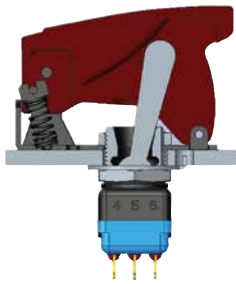

Standard



With K sealing option

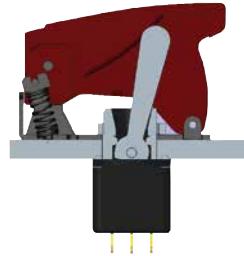

With X408 sealing option

## BUILD YOUR PART NUMBER

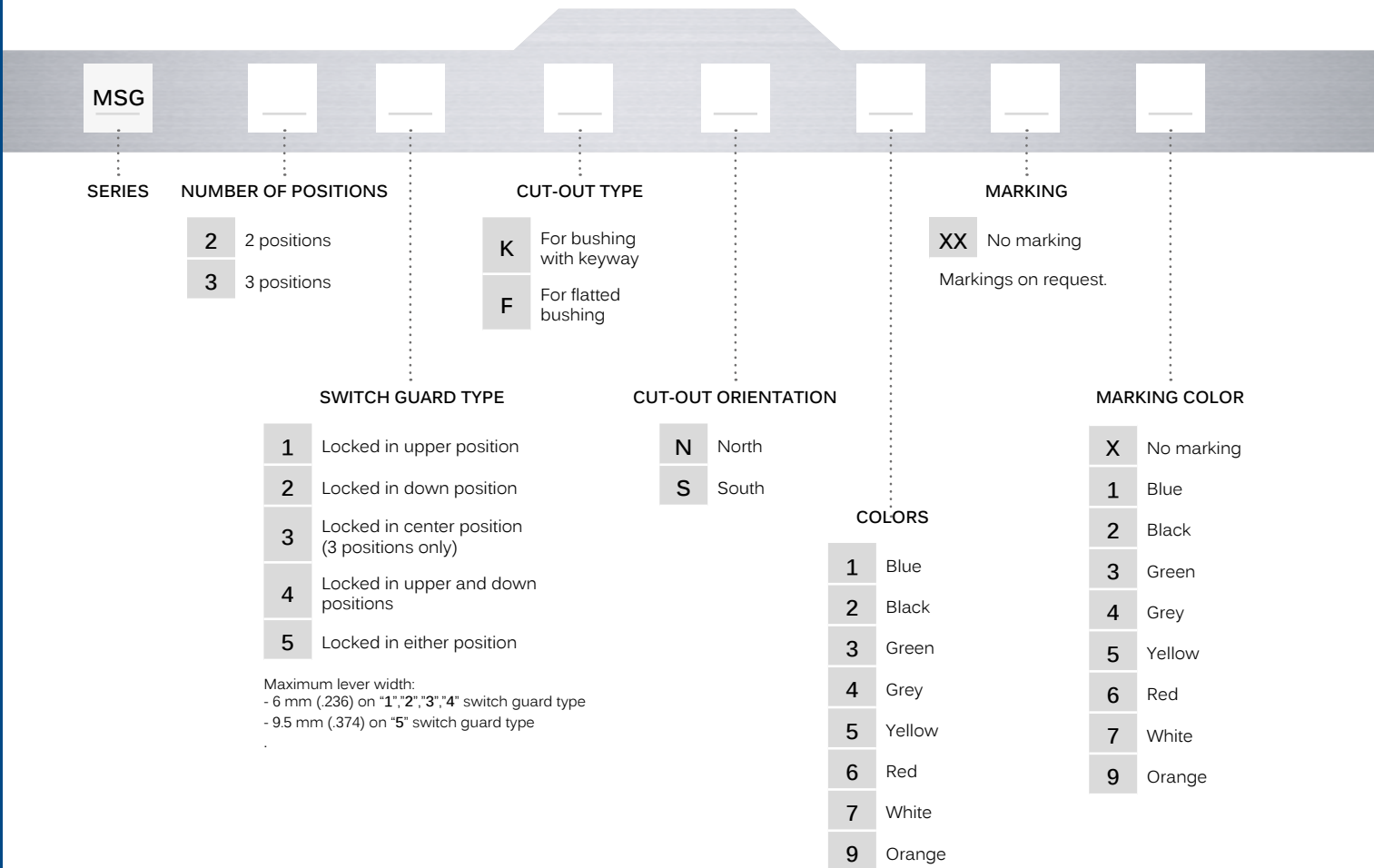

## ABOUT THIS SERIES

On the following pages, you will find successively basic part numbers and options in the same order as in above chart.

- Notice** : please note that not all combinations of above numbers are available. Refer to the following pages for further information.
- Mounting accessories** : supplied with the switch or to order separately (see "Hardware" section of website).

# MSG series

Rugged switch guards for switch series 12000 - 3500 - 600H - 6000

## DIMENSIONS



Note : Ø 1.80 mm holes for wiring a seal are standard on all models.

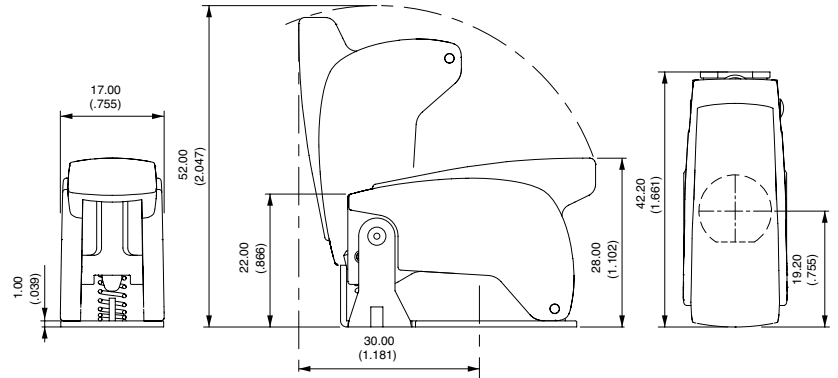

## NUMBER OF POSITIONS

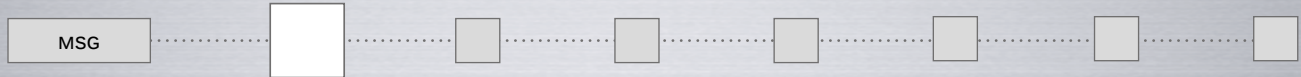

- 2 2 positions
- 3 3 positions

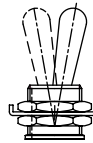

2



3

## SWITCH GUARD TYPE



- 1 Locked in upper position
- 2 Locked in down position
- 3 Locked in center position (3 positions only)
- 4 Locked in upper and down positions
- 5 Locked in either position

Maximum lever width:

- 6 mm (.236) on "1","2","3","4" switch guard type
- 9.5 mm (.374) on "5" switch guard type



1

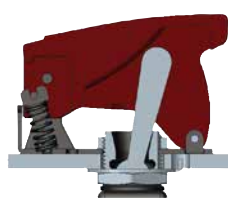

2

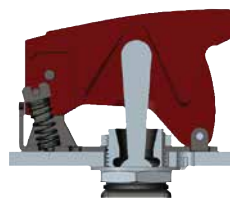

3

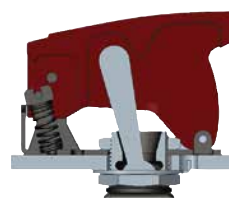

4

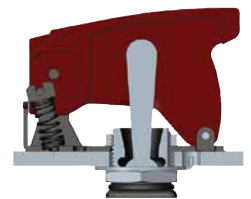

5

# MSG series

Rugged switch guards for switch series 12000 - 3500 - 600H - 6000

## CUT-OUT TYPE



- K For bushing with keyway
- F For flatted bushing



K



F

## CUT-OUT ORIENTATION

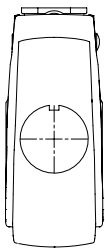

N

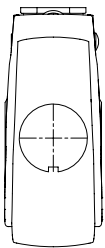

S

## COLORS

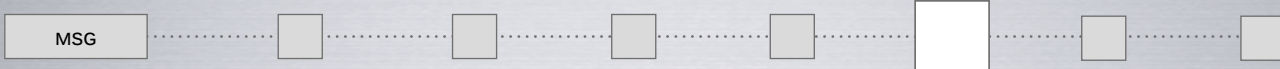

- 1 Blue
- 2 Black
- 3 Green
- 4 Grey
- 5 Yellow
- 6 Red
- 7 White
- 9 Orange



## MARKING

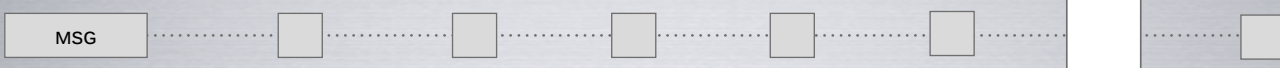

- XX No marking
- On request.

## MARKING COLOR

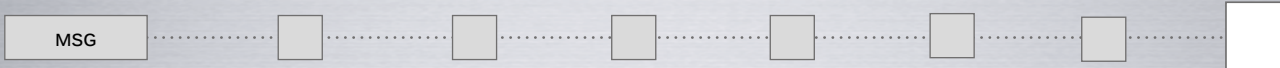

- |    |            |   |        |   |        |
|----|------------|---|--------|---|--------|
| XX | No marking | 3 | Green  | 6 | Red    |
| 1  | Blue       | 4 | Grey   | 7 | White  |
| 2  | Black      | 5 | Yellow | 9 | Orange |

# Mouser Electronics

Authorized Distributor

Click to View Pricing, Inventory, Delivery & Lifecycle Information:

[Apem:](#)

[MSG24KN6XXX](#) [MSG33KN6XXX](#) [MSG22KN6XXX](#) [MSG22KS6XXX](#) [MSG24KS6XXX](#) [MSG31KS6XXX](#)  
[MSG24FN2XXX](#) [MSG33FN6XXX](#) [MSG33FN3XXX](#) [MSG21KN6XXX](#) [MSG24FS6XXX](#) [MSG25FN2XXX](#)  
[MSG35KN6XXX](#) [MSG22KS2XXX](#) [MSG22FN1XXX](#)