

Utilizing the latest Field Stop and Trench Gate technologies, these IGBT's have ultra low $V_{CE(ON)}$ and are ideal for low frequency applications that require absolute minimum conduction loss. Easy paralleling is a result of very tight parameter distribution and a slightly positive $V_{CE(ON)}$ temperature coefficient. A built-in gate resistor ensures extremely reliable operation, even in the event of a short circuit fault. Low gate charge simplifies gate drive design and minimizes losses.

- 1200V Field Stop
- Trench Gate: Low $V_{CE(ON)}$
- Easy Paralleling
- Integrated Gate Resistor: Low EMI, High Reliability
- RoHS Compliant



Applications: Welding, Inductive Heating, Solar Inverters, SMPS, Motor drives, UPS

Maximum Ratings

All Ratings: $T_C = 25^\circ C$ unless otherwise specified.

Symbol	Parameter	Ratings	Unit
V_{CES}	Collector-Emitter Voltage	1200	Volts
V_{GE}	Gate-Emitter Voltage	± 30	
I_{C1}	Continuous Collector Current @ $T_C = 25^\circ C$	215	Amps
I_{C2}	Continuous Collector Current @ $T_C = 100^\circ C$	99	
I_{CM}	Pulsed Collector Current ^①	450	
SSOA	Switching Safe Operating Area @ $T_J = 150^\circ C$	450A @ 1200V	
P_D	Total Power Dissipation	625	Watts
T_J, T_{STG}	Operating and Storage Junction Temperature Range	-55 to 150	$^\circ C$

Static Electrical Characteristics

Symbol	Characteristic / Test Conditions	Min	Typ	Max	Unit
$V_{(BR)CES}$	Collector-Emitter Breakdown Voltage ($V_{GE} = 0V, I_C = 6mA$)	1200	-	-	Volts
$V_{GE(TH)}$	Gate Threshold Voltage ($V_{CE} = V_{GE}, I_C = 6mA, T_J = 25^\circ C$)	5.0	5.8	6.5	
$V_{CE(ON)}$	Collector Emitter On Voltage ($V_{GE} = 15V, I_C = 150A, T_J = 25^\circ C$)	1.4	1.7	2.1	
	Collector Emitter On Voltage ($V_{GE} = 15V, I_C = 150A, T_J = 125^\circ C$)	-	2.08	-	
I_{CES}	Collector Cut-off Current ($V_{CE} = 1200V, V_{GE} = 0V, T_J = 25^\circ C$) ^②	-	-	300	μA
	Collector Cut-off Current ($V_{CE} = 1200V, V_{GE} = 0V, T_J = 125^\circ C$) ^②	-	-	TBD	
I_{GES}	Gate-Emitter Leakage Current ($V_{GE} = \pm 20V$)	-	-	600	nA
$R_{G(int)}$	Integrated Gate Resistor	-	5	-	Ω

 CAUTION: These Devices are Sensitive to Electrostatic Discharge. Proper Handling Procedures Should Be Followed.

Dynamic Characteristic

APT150GN120JDQ4

Symbol	Characteristic	Test Conditions	Min	Typ	Max	Unit
C_{ies}	Input Capacitance	$V_{GE} = 0V, V_{CE} = 25V$ $f = 1MHz$	-	9500	-	pF
C_{oes}	Output Capacitance		-	500	-	
C_{res}	Reverse Transfer Capacitance		-	400	-	
V_{GEP}	Gate-to-Emitter Plateau Voltage	Gate Charge $V_{GE} = 15V$ $V_{CE} = 600V$ $I_C = 150A$	-	9.5	-	V
Q_g	Total Gate Charge ^③		-	800	-	nC
Q_{ge}	Gate-Emitter Charge		-	70	-	
Q_{gc}	Gate-Collector Charge		-	430	-	
SSOA	Switching Safe Operating Area	$T_J = 150^\circ C, R_G = 1.0\Omega^{⑦}, V_{GE} = 15V,$ $L = 100\mu H, V_{CE} = 1200V$	450			A
$t_{d(on)}$	Turn-On Delay Time	Inductive Switching (25°C) $V_{CC} = 800V$ $V_{GE} = 15V$ $I_C = 150A$ $R_G = 1.0\Omega^{⑦}$ $T_J = +25^\circ C$	-	55	-	ns
t_r	Current Rise Time		-	65	-	
$t_{d(off)}$	Turn-Off Delay Time		-	675	-	
t_f	Current Fall Time		-	85	-	μJ
E_{on1}	Turn-On Switching Energy ^④		-	22	-	
E_{on2}	Turn-On Switching Energy ^⑤		-	27	-	
E_{off}	Turn-Off Switching Energy ^⑥	-	15	-		
$t_{d(on)}$	Turn-On Delay Time	Inductive Switching (125°C) $V_{CC} = 800V$ $V_{GE} = 15V$ $I_C = 150A$ $R_G = 1.0\Omega^{⑦}$ $T_J = +125^\circ C$	-	55	-	ns
t_r	Current Rise Time		-	65	-	
$t_{d(off)}$	Turn-Off Delay Time		-	780	-	
t_f	Current Fall Time		-	175	-	mJ
E_{on1}	Turn-On Switching Energy ^④		-	23	-	
E_{on2}	Turn-On Switching Energy ^⑤		-	35	-	
E_{off}	Turn-Off Switching Energy ^⑥	-	22	-		

Thermal and Mechanical Characteristics

Symbol	Characteristic / Test Conditions	Min	Typ	Max	Unit
$R_{\theta JC}$	Junction to Case (IGBT)	-	-	0.20	°C/W
$R_{\theta JC}$	Junction to Case (DIODE)	-	-	0.56	
W_T	Package Weight	-	29.2	-	g
Torque	Terminals and Mounting Screws.	-	-	10	in-lbf
		-	-	1.1	N·m
$V_{Isolation}$	RMS Voltage (50-60Hz Sinusoidal Waveform from Terminals to Mounting Base for 1 Min.)	2500	-	-	Volts

- ① Repetitive Rating: Pulse width limited by maximum junction temperature.
- ② For Combi devices, I_{ces} includes both IGBT and FRED leakages.
- ③ See MIL-STD-750 Method 3471.
- ④ E_{on1} is the clamped inductive turn-on energy of the IGBT only, without the effect of a commutating diode reverse recovery current adding to α the IGBT turn-on loss. Tested in inductive switching test circuit shown in figure 21, but with a Silicon Carbide diode.
- ⑤ E_{on2} is the clamped inductive turn-on energy that includes a commutating diode reverse recovery current in the IGBT turn-on switching loss. (See Figures 21, 22.)
- ⑥ E_{off} is the clamped inductive turn-off energy measured in accordance with JEDEC standard JESD24-1. (See Figures 21, 23.)
- ⑦ R_G is external gate resistance not including gate driver impedance.

Microsemi reserves the right to change, without notice, the specifications and information contained herein.

Typical Performance Curves

APT150GN120JDQ4

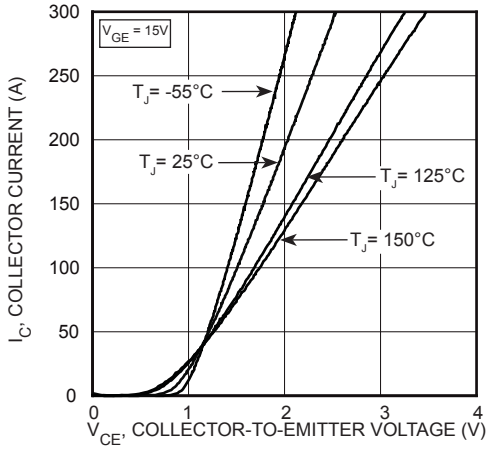

FIGURE 1, Output Characteristics ($T_J = 25^\circ\text{C}$)

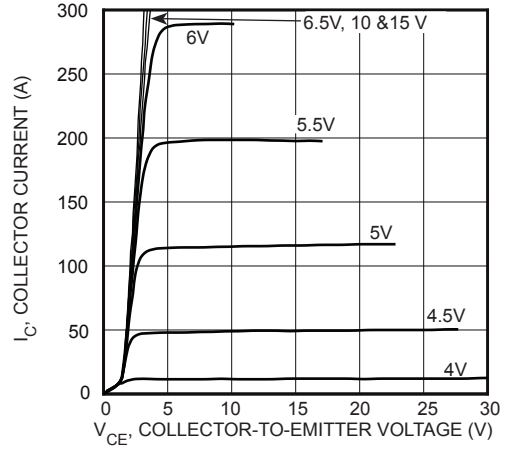

FIGURE 2, Output Characteristics ($T_J = 25^\circ\text{C}$)

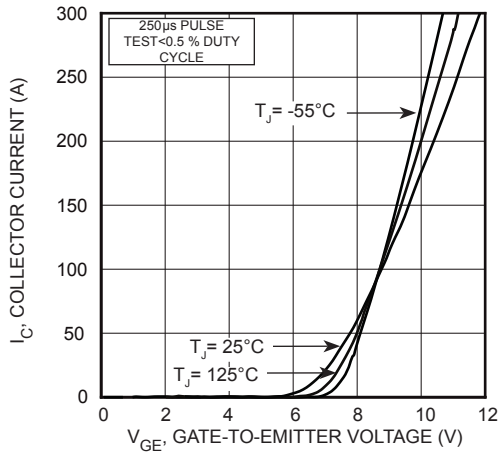

FIGURE 3, Transfer Characteristics

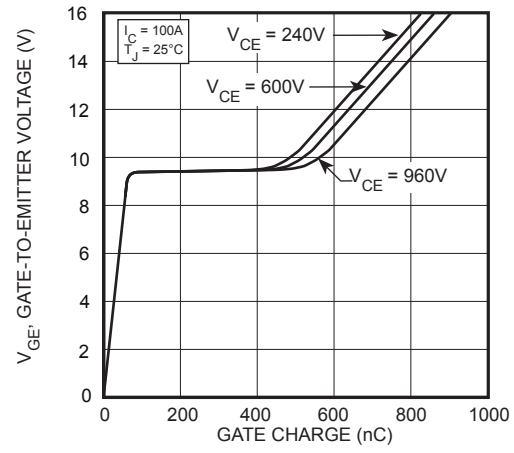

FIGURE 4, Gate charge

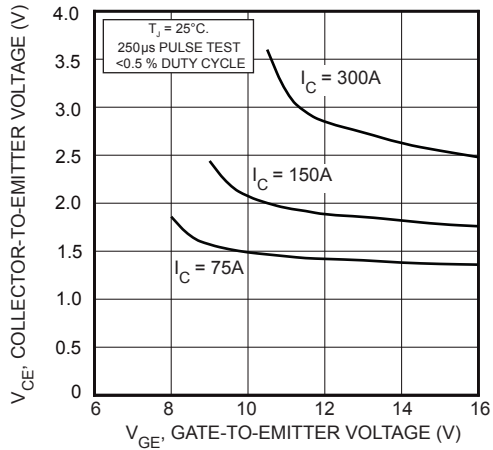

FIGURE 5, On State Voltage vs Gate-to-Emitter Voltage

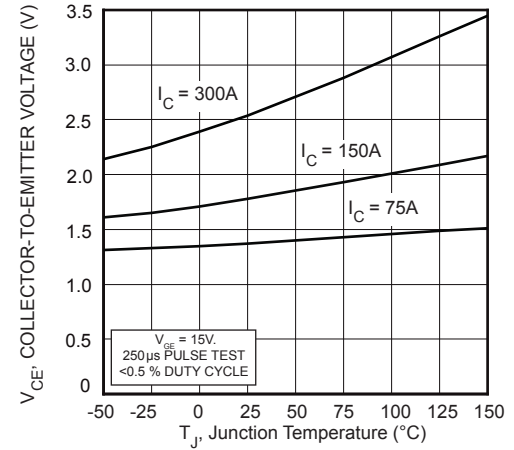

FIGURE 6, On State Voltage vs Junction Temperature

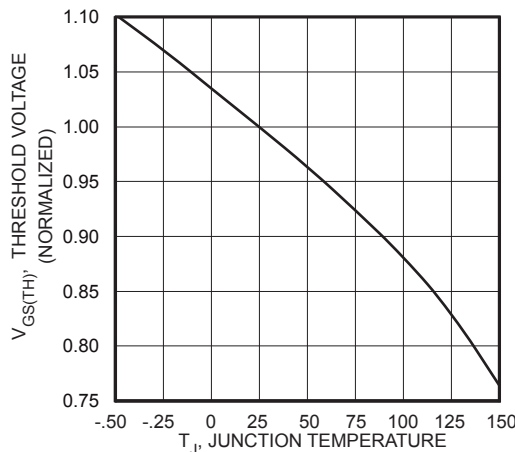

FIGURE 7, Threshold Voltage vs Junction Temperature

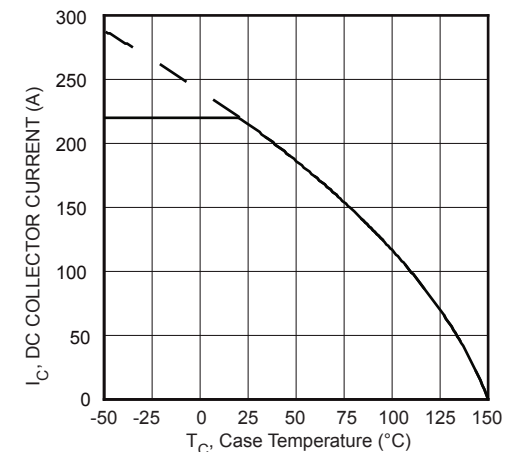

FIGURE 8, DC Collector Current vs Case Temperature

Typical Performance Curves

APT150GN120JDQ4

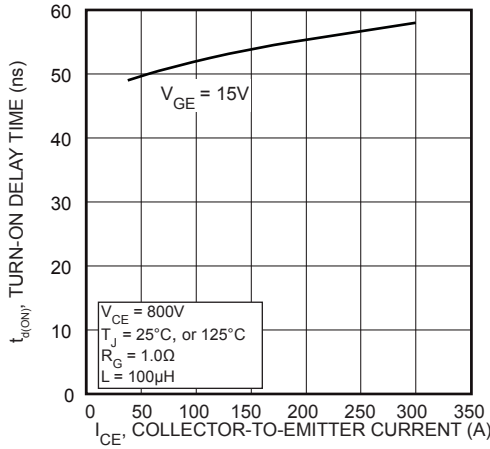

FIGURE 9, Turn-On Delay Time vs Collector Current

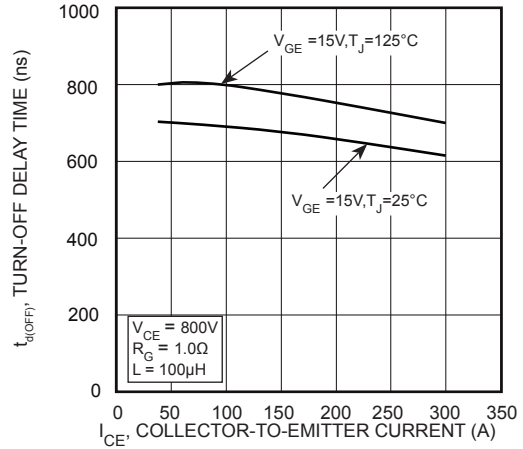

FIGURE 10, Turn-Off Delay Time vs Collector Current

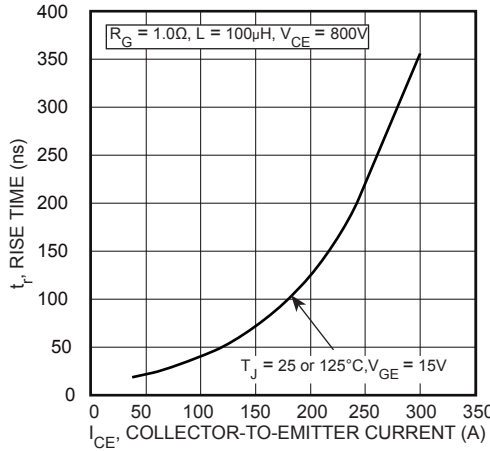

FIGURE 11, Current Rise Time vs Collector Current

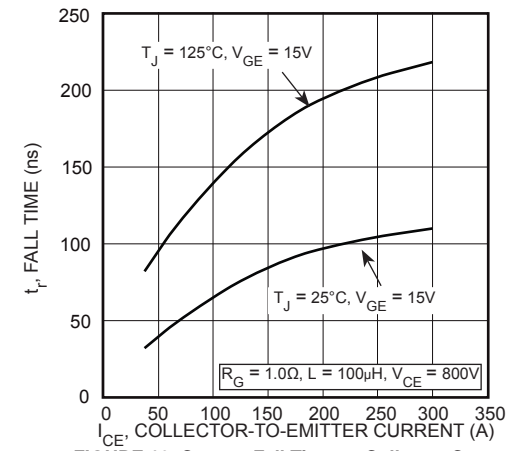

FIGURE 12, Current Fall Time vs Collector Current

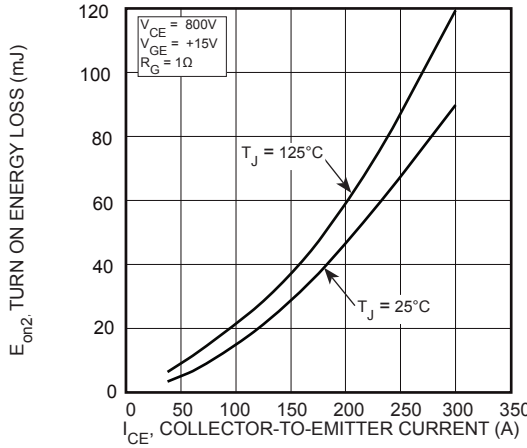

FIGURE 13, Turn-On Energy Loss vs Collector Current

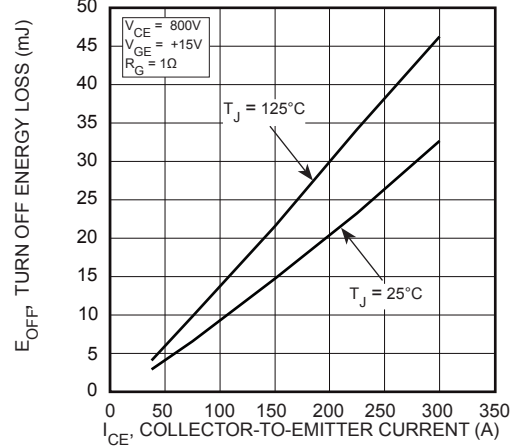

FIGURE 14, Turn-Off Energy Loss vs Collector Current

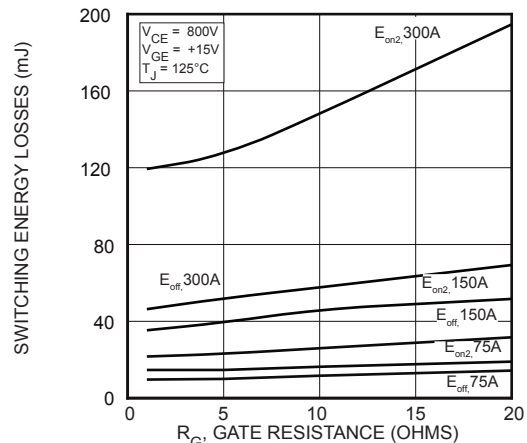

FIGURE 15, Switching Energy Losses vs Gate Resistance

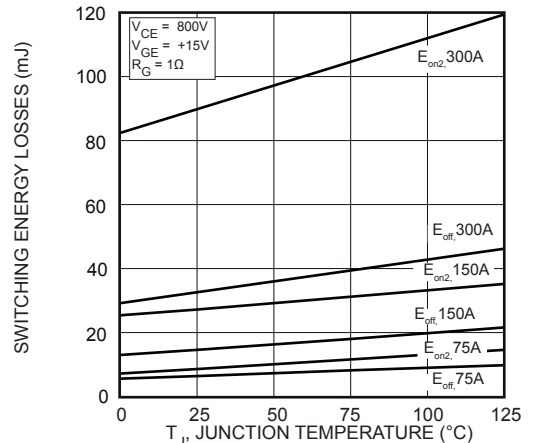
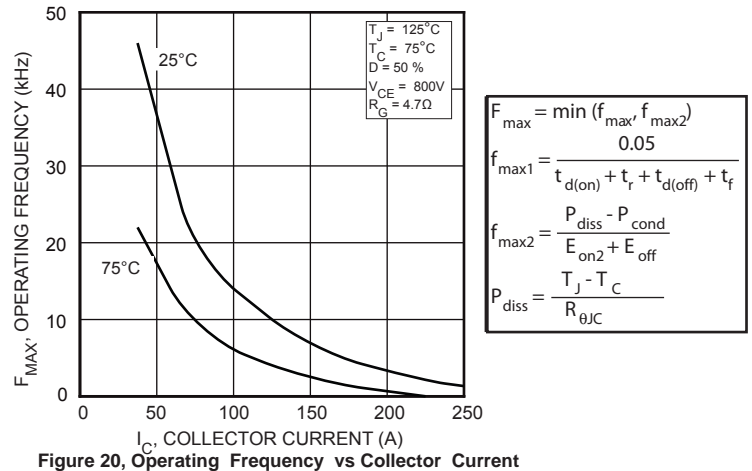
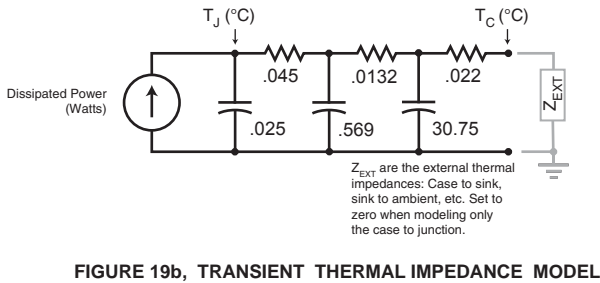
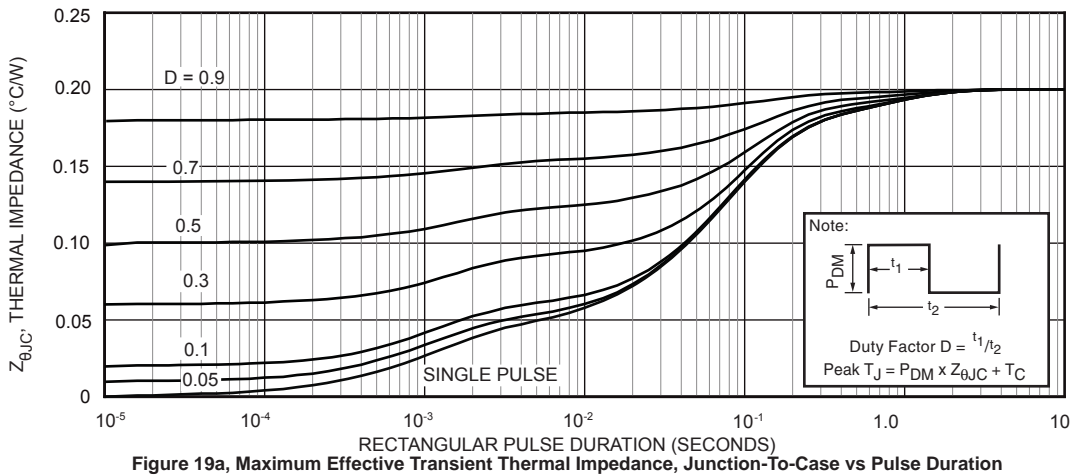
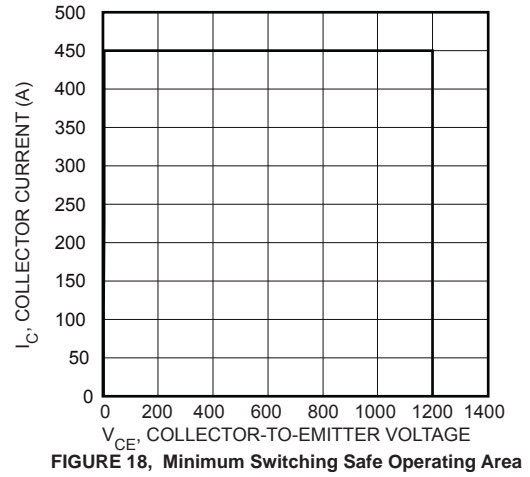
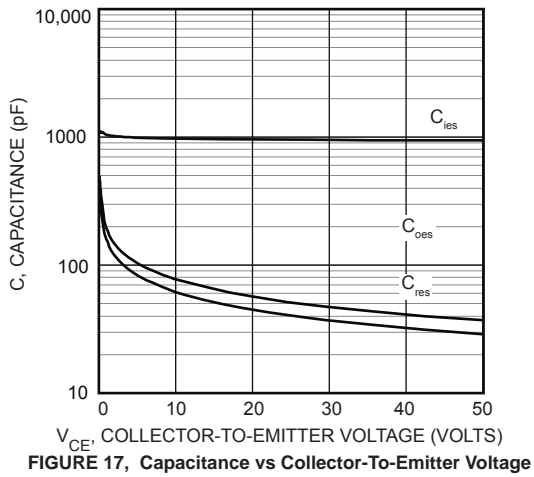

FIGURE 16, Switching Energy Losses vs Junction Temperature

Typical Performance Curves

APT150GN120JDQ4



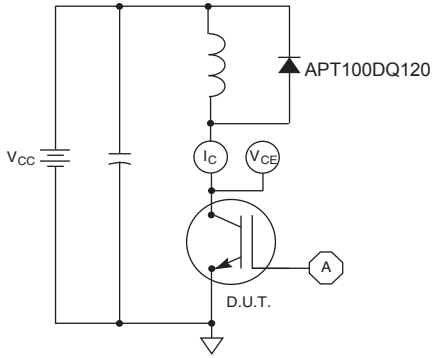

Figure 21, Inductive Switching Test Circuit

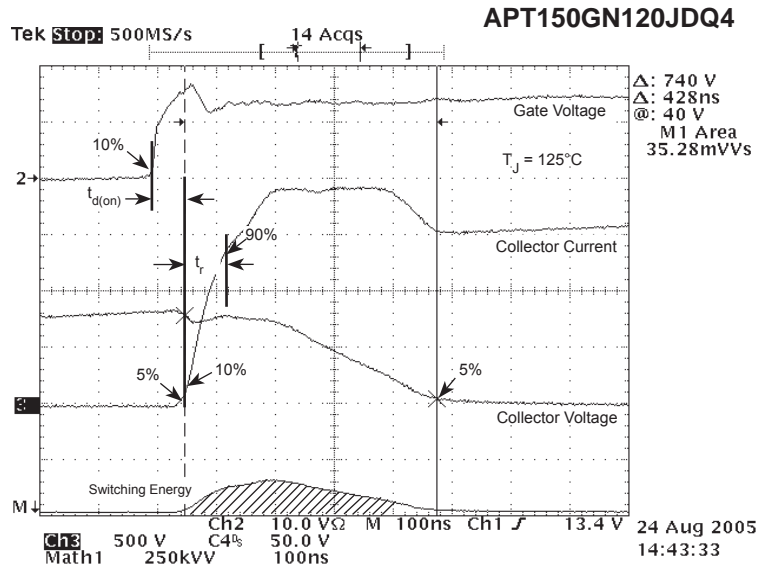

Figure 22, Turn-on Switching Waveforms and Definitions

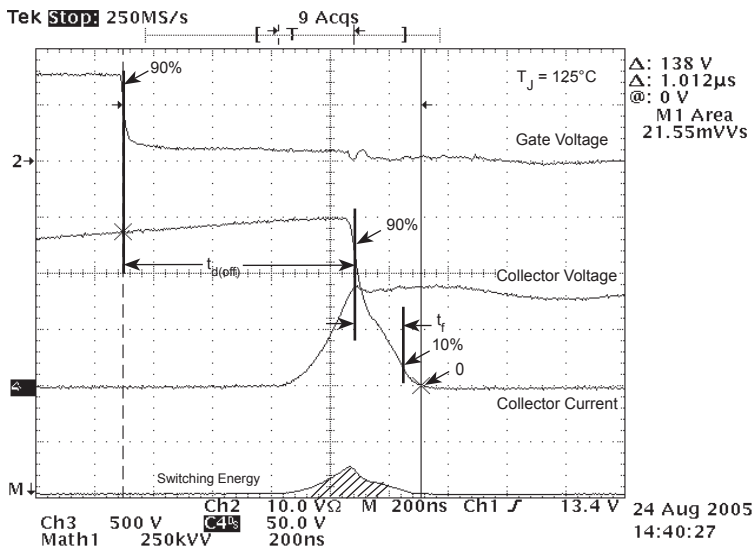

Figure 23, Turn-off Switching Waveforms and Definitions

ULTRAFAST SOFT RECOVERY ANTI-PARALLEL DIODE

MAXIMUM RATINGS

All Ratings: $T_C = 25^\circ\text{C}$ unless otherwise specified.

Symbol	Characteristic / Test Conditions	APT150GN120JRDQ4	Unit
$I_{F(AV)}$	Maximum Average Forward Current ($T_C = 88^\circ\text{C}$, Duty Cycle = 0.5)	60	Amps
$I_{F(RMS)}$	RMS Forward Current (Square wave, 50% duty)	73	
I_{FSM}	Non-Repetitive Forward Surge Current ($T_J = 45^\circ\text{C}$, 8.3 ms)	540	

STATIC ELECTRICAL CHARACTERISTICS

Symbol	Characteristic / Test Conditions	Min	Type	Max	Unit
V_F	Forward Voltage		$I_F = 75\text{A}$	2.7	Volts
			$I_F = 150\text{A}$	3.4	
			$I_F = 75\text{A}, T_J = 125^\circ\text{C}$	2.1	

DYNAMIC CHARACTERISTICS

Symbol	Characteristic	Test Conditions	Min	Typ	Max	Unit
t_{rr}	Reverse Recovery Time	$I_F = 1\text{A}, di_F/dt = -100\text{A}/\mu\text{s}, V_R = 30\text{V}, T_J = 25^\circ\text{C}$	-	60	-	ns
t_{rr}	Reverse Recovery Time	$I_F = 60\text{A}, di_F/dt = -200\text{A}/\mu\text{s}, V_R = 800\text{V}, T_C = 25^\circ\text{C}$	-	265	-	ns
Q_{rr}	Reverse Recovery Charge		-	560	-	nC
I_{RRM}	Maximum Reverse Recovery Current		-	5	-	Amps
t_{rr}	Reverse Recovery Time	$I_F = 60\text{A}, di_F/dt = -200\text{A}/\mu\text{s}, V_R = 800\text{V}, T_C = 125^\circ\text{C}$	-	350	-	ns
Q_{rr}	Reverse Recovery Charge		-	2890	-	nC
I_{RRM}	Maximum Reverse Recovery Current		-	13	-	Amps
t_{rr}	Reverse Recovery Time	$I_F = 60\text{A}, di_F/dt = -1000\text{A}/\mu\text{s}, V_R = 800\text{V}, T_C = 125^\circ\text{C}$	-	150	-	ns
Q_{rr}	Reverse Recovery Charge		-	4720	-	nC
I_{RRM}	Maximum Reverse Recovery Current		-	40	-	Amps

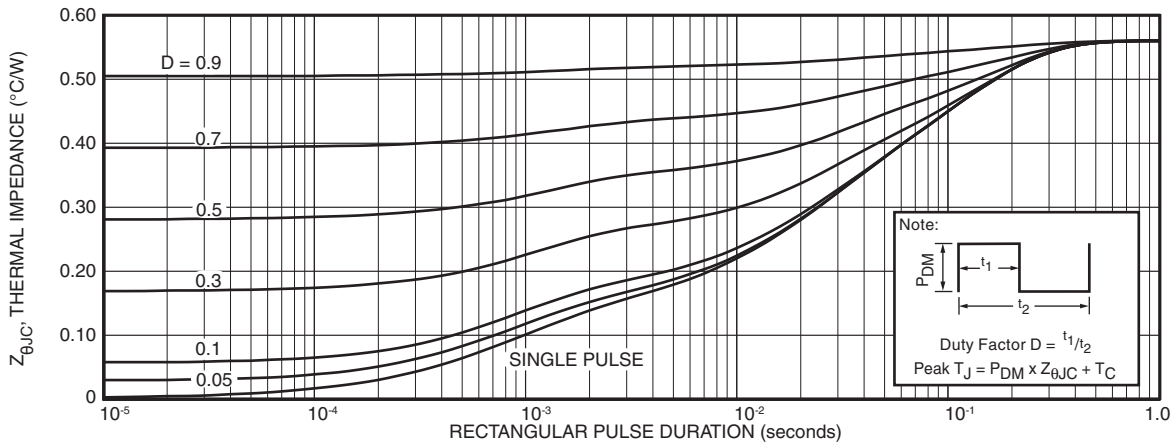

FIGURE 24a. MAXIMUM EFFECTIVE TRANSIENT THERMAL IMPEDANCE, JUNCTION-TO-CASE vs. PULSE DURATION

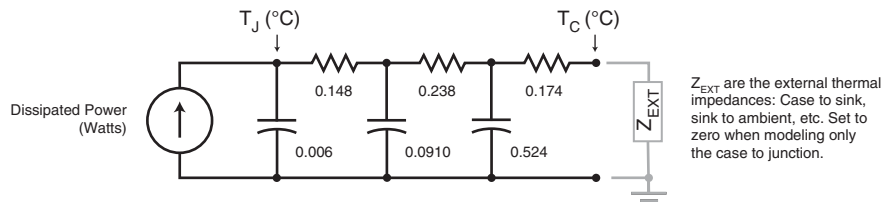

FIGURE 24b. TRANSIENT THERMAL IMPEDANCE MODEL

Typical Performance Curves

APT150GN120JDQ4

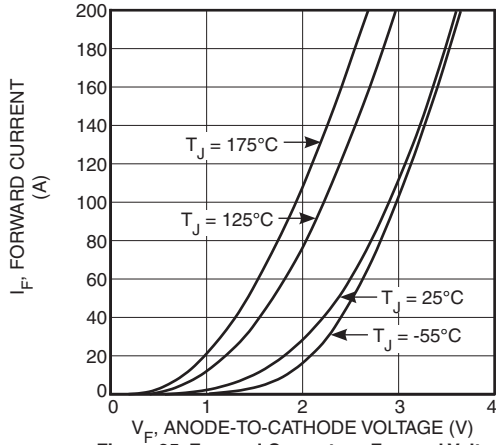

Figure 25. Forward Current vs. Forward Voltage

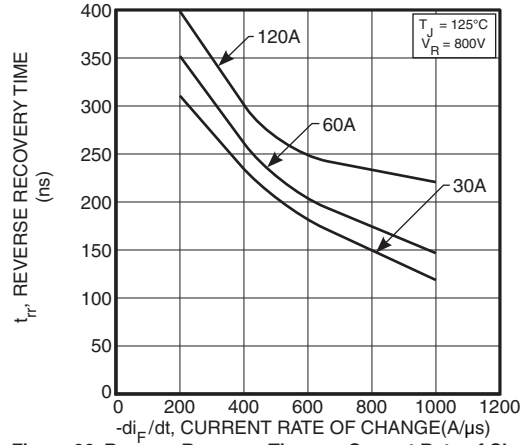

Figure 26. Reverse Recovery Time vs. Current Rate of Change

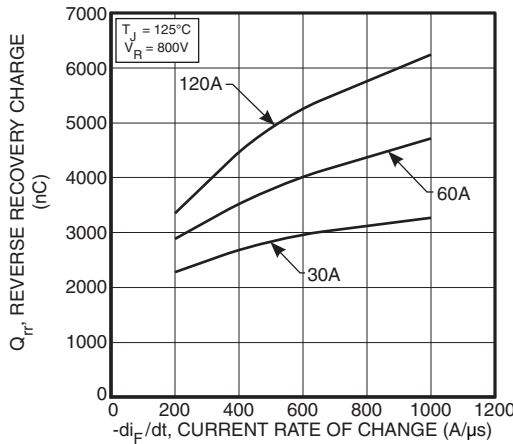

Figure 27. Reverse Recovery Charge vs. Current Rate of Change

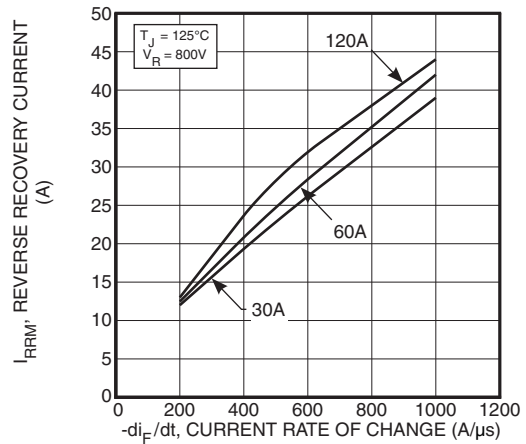

Figure 28. Reverse Recovery Current vs. Current Rate of Change

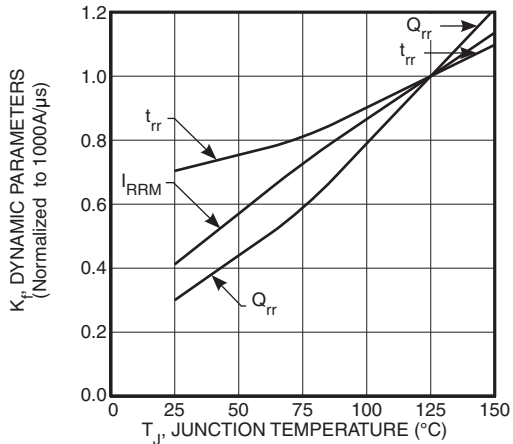

Figure 29. Dynamic Parameters vs. Junction Temperature

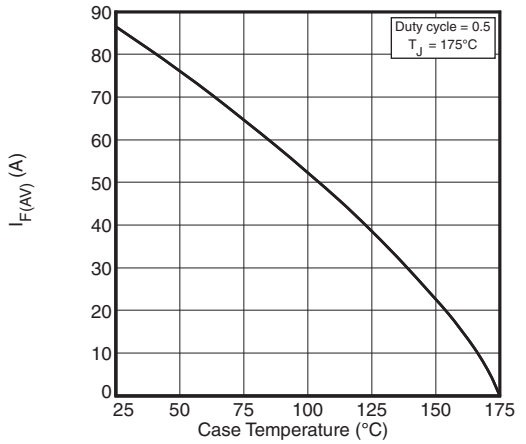

Figure 30. Maximum Average Forward Current vs. Case Temperature

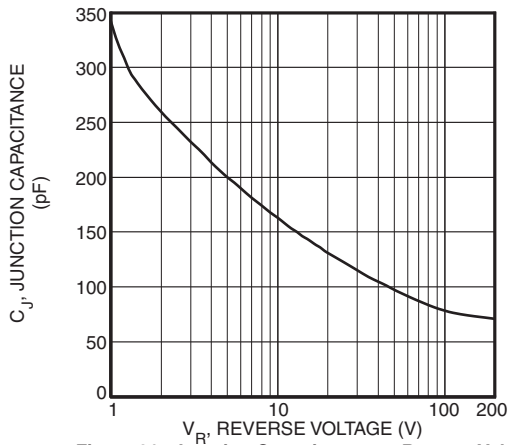

Figure 31. Junction Capacitance vs. Reverse Voltage

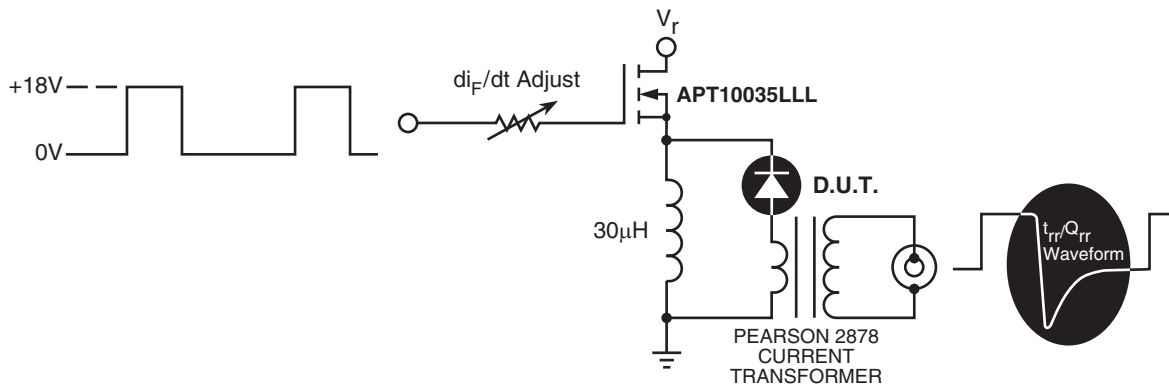

Figure 32, Diode Test Circuit

- 1 I_F - Forward Conduction Current
- 2 di_F/dt - Rate of Diode Current Change Through Zero Crossing.
- 3 I_{RRM} - Maximum Reverse Recovery Current.
- 4 t_{rr} - Reverse Recovery Time, measured from zero crossing where diode current goes from positive to negative, to the point at which the straight line through I_{RRM} and $0.25 \cdot I_{RRM}$ passes through zero.
- 5 Q_{rr} - Area Under the Curve Defined by I_{RRM} and t_{rr} .

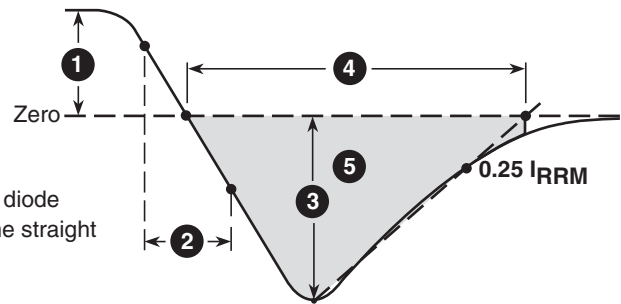
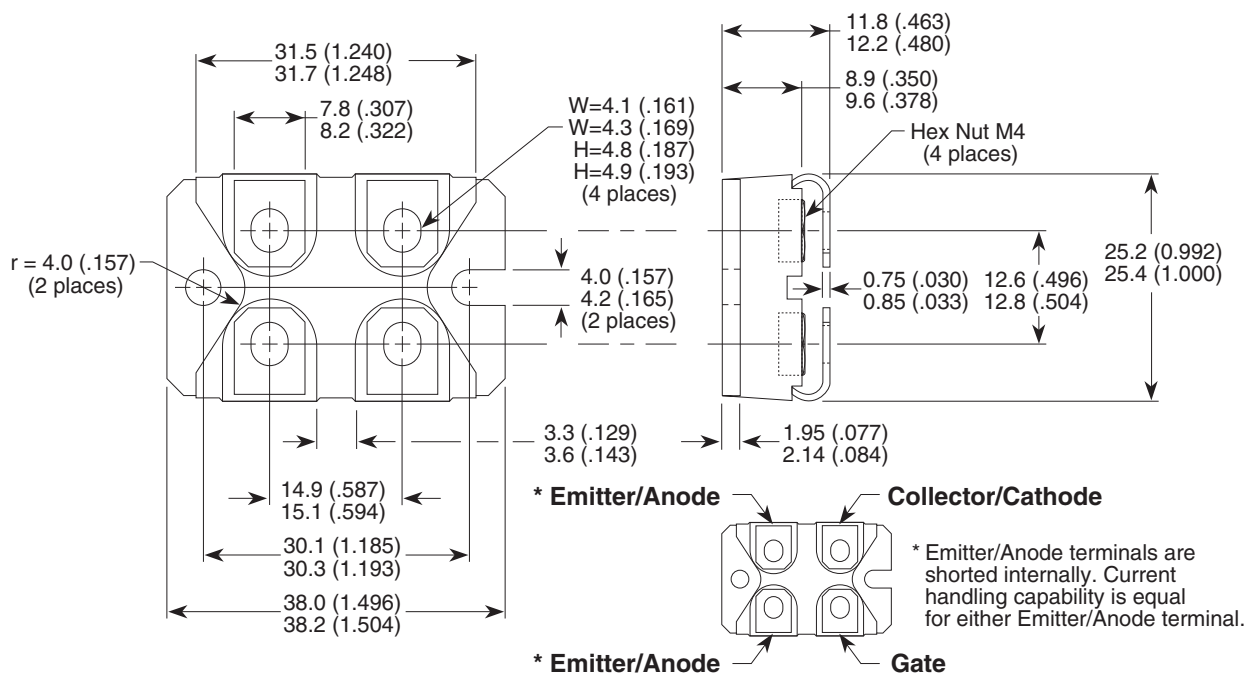

Figure 33, Diode Reverse Recovery Waveform and Definitions

SOT-227 (ISOTOP®) Package Outline



Dimensions in Millimeters and (Inches)

Mouser Electronics

Authorized Distributor

Click to View Pricing, Inventory, Delivery & Lifecycle Information:

[Microchip:](#)

[APT150GN120JDQ4](#)