



CGS

TE Part # 2-1623746-2

TE Internal #: ER742K2JT

[View on TE.com >](#)

Passive Components > Resistors > Fixed Resistors > Through-Hole Resistors



Resistor Type: **Power Resistor**

Dimensions: **13.5 x 6 mm**

Number of Terminations: **2**

Packaging Method: **Ammo Packed**

Tolerance: **5%**

Features

Product Type Features

Product Type	Fixed Resistor
Resistor Type	Power Resistor
Element Type	Wirewound

Configuration Features

Number of Resistors	1
---------------------	---

Electrical Characteristics

Voltage Rating	100 V
Tolerance	5%
Resistance Class	1kΩ – 1MΩ
Resistance	2.2K Ω
Power Rating	3 W

Body Features

Lead Type	Axial Ledged
-----------	--------------

Termination Features

Number of Terminations	2
Termination Type	Tinned Copper Leads

Mechanical Attachment

Mount Style	Axial Ledged
-------------	--------------

Dimensions

Dimensions	13.5 x 6 mm
------------	-------------

Usage Conditions

Operating Temperature Range	-55 – 200 °C
Temperature Coefficient	0 – 60 ppm/°C

Packaging Features

Packaging Method	Ammo Packed
------------------	-------------

Product Compliance

[For compliance documentation, visit the product page on TE.com>](#)

EU RoHS Directive 2011/65/EU	Compliant
EU ELV Directive 2000/53/EC	Compliant
China RoHS 2 Directive MIIT Order No 32, 2016	No Restricted Materials Above Threshold
EU REACH Regulation (EC) No. 1907/2006	Current ECHA Candidate List: JAN 2019 (197) Candidate List Declared Against: JUN 2018 (191)
Halogen Content	Low Halogen - Br, Cl, F, I < 900 ppm per homogenous material. Also BFR/CFR/PVC Free
Solder Process Capability	Wave solder capable to 265°C

Product Compliance Disclaimer

This information is provided based on reasonable inquiry of our suppliers and represents our current actual knowledge based on the information they provided. This information is subject to change. The part numbers that TE has identified as EU RoHS compliant have a maximum concentration of 0.1% by weight in homogenous materials for lead, hexavalent chromium, mercury, PBB, PBDE, DBP, BBP, DEHP, DIBP, and 0.01% for cadmium, or qualify for an exemption to these limits as defined in the Annexes of Directive 2011/65/EU (RoHS2). Finished electrical and electronic equipment products will be CE marked as required by Directive 2011/65/EU. Components may not be CE marked. Additionally, the part numbers that TE has identified as EU ELV compliant have a maximum concentration of 0.1% by weight in homogenous materials for lead, hexavalent chromium, and mercury, and 0.01% for cadmium, or qualify for an exemption to these limits as defined in the Annexes of Directive 2000/53/EC (ELV). Regarding the REACH Regulations, TE's information on SVHC in articles for this part number is still based on the European Chemical Agency (ECHA) 'Guidance on requirements for substances in articles' (Version: 2, April 2011), applying the 0.1% weight on weight concentration threshold at the finished product level. TE is aware of the European Court of Justice ruling of September 10th, 2015 also known as O5A (Once An Article Always An Article) stating that, in case of 'complex object', the threshold for a SVHC must be applied to both the product as a whole and simultaneously to each of the articles forming part of its composition. TE has evaluated this ruling based on the new ECHA "Guidance on requirements for substances in articles" (June 2017, version 4.0) and will be updating its statements accordingly.

Compatible Parts

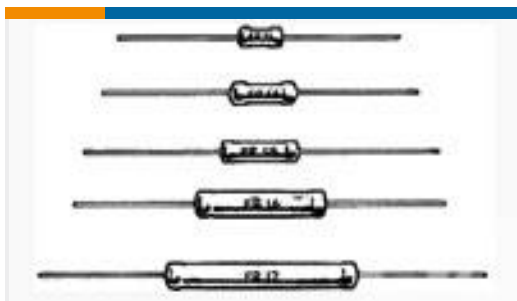

TE Part # 4-1623750-7
ER58 R22 5% AMMO

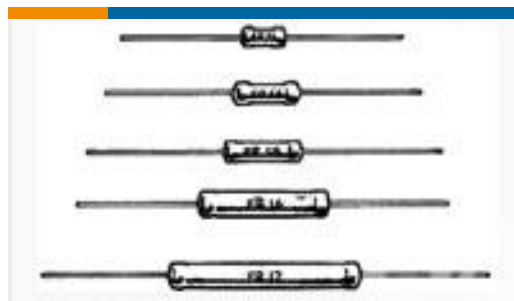

TE Part # 1-1623746-3
ER74 1R0 5% AMMO PK

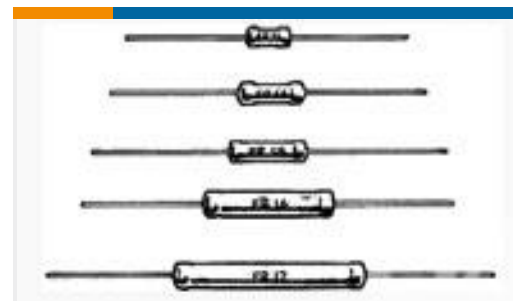

TE Part # 6-1623746-9
ER74 R05 10% AMMO PK

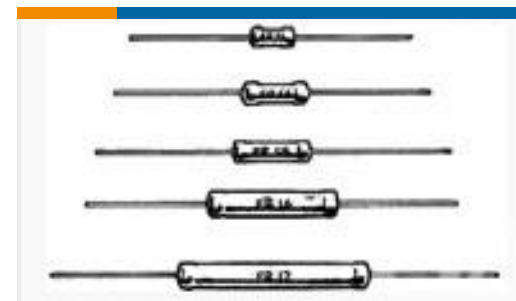

TE Part # 1623749-6
ER17 22K 5% LOOSE

Customers Also Bought



TE Part #3-1879233-4
SMW5 2R4 5%

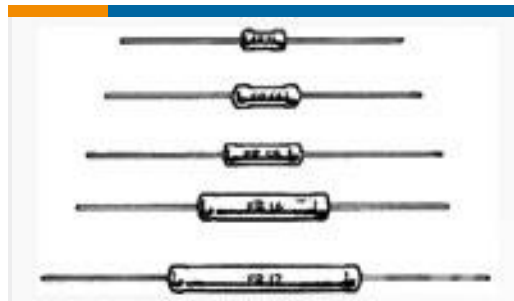

TE Part #1-1623746-0
ER74 1K0 5% AMMO PK



TE Part #9-1625971-9
HSA25 R15 5%



TE Part #8-1625892-2
3W SM M/OX 5% 270K



TE Part #1825010-6
ASE22L04=DPDT
AUTOSLIDE



TE Part #5-1419124-6
OSA-SS-212DM3,000

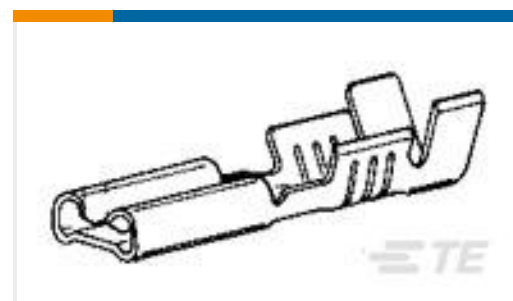

TE Part #160626-1
110 FASTON IS



TE Part #1623895-6
416X 2K

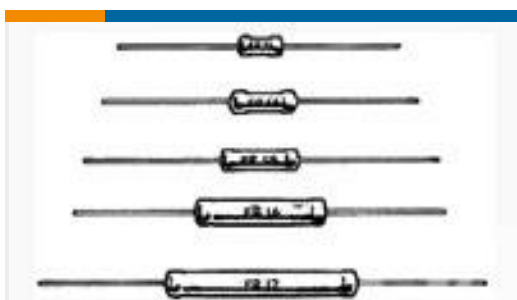

TE Part #3-1623746-7
ER74 4K7 5% AMMO PK



TE Part #8-1879745-9
RP 1J 4K53 0.1% 15PPM
CUT LENGTH

Documents

Product Drawings
ER74 2K2 5% AMMO PK
English

CAD Files
3D PDF
3D

Customer View Model
ENG_CVM_CVM_2-1623746-2_BA.2d_dxf.zip



English

Customer View Model

[ENG_CVM_CVM_2-1623746-2_BA.3d_igs.zip](#)

English

Customer View Model

[ENG_CVM_CVM_2-1623746-2_BA.3d_stp.zip](#)

English

Datasheets & Catalog Pages

[1309350_PASSIVE_COMPONENT](#)

English

[4-1773460-6_RESISTIVE_SOLUTIONS_RAIL](#)

English

[Type ER/ERV Series High Power Resistors](#)

English

[8-1773459-4_POWER_FILTERING_AND_RESISTIVE_SOLUTIONS_FOR_ELEVATORS_AND_ESCALATORS](#)

English