







Expertise – Passion – Automation



Pneumatic Piping Equipment

Pneumatic Piping Equipment

	Fittings	31
	Speed Controllers with One-touch Fitting	185
	Tubing	257
	Blow Guns	314
	Silencers	314

INDEX Piping Equipment

Fittings

One-touch fittings KQ2 P.36	Face seal One-touch fittings KQ2 P.50	Uni One-touch fittings KQ2 P.58	Metal One-touch fittings KQB2 P.68, 73
Self-align fittings H,DL,L,LL P.90	Self-seal fittings KC P.93	S couplers KK P.96	S couplers KKH P.99
Rotary Joint MQR P.109	Piping module KB P.113	FR One-touch fittings KR-W2 P.118	FR One-touch fittings manifold KRM P.123
Miniature fittings MS P.143	S couplers stainless steel type KKA P.146	Clean One-touch fittings KP P.150	Clean One-touch fittings KPQ/KPG P.153

Speed Controllers with One-touch Fitting

Elbow/Universal type Push-lock type AS□□□1F-A P.191	Elbow/Universal type Push-lock type, Face seal AS□□□1F-A P.193	Elbow/Universal type In-line type AS□2F-A P.195	Elbow/Universal type Speed controller with indicator AS-FS P.196
Elbow type Metal body AS□□□1F P.207	Flame resistant/Elbow type screwdriver adjustable AS□2□1F-W2D P.209	Speed controller, Metal Exterior AS-X737 P.210	In-line type AS□2F P.211
With Uni One-touch fitting Push-lock type AS□□□1F-U□-A P.215	With indicator/Uni thread type Push-lock type AS-FS P.217	With Uni One-touch fitting AS□□□1F-U P.219	Stainless steel/Elbow type Push-lock type AS-FG P.223
Stainless steel In-line type AS□1FG P.231	Stainless steel Dual speed controller ASD□30FG P.232	Stainless steel Elbow type ASG P.233	Clean speed controller with One-touch fitting AS-FPQ/FPG P.235
Adjustable by flat head screwdriver In-line type AS□1F-D P.243	Dual speed controller adjustable by flat head screwdriver ASD□30F-D P.244	Tamper Proof Elbow/Universal type AS□□□1F-T P.245	Tamper proof In-line type AS□1F-T P.247
Air saving valve ASR/ASQ P.252	Holder for speed controller TMH P.254	Residual pressure release valve with One-touch fittings KE□ P.254	Multi-holder TMA P.254

Tubing

Nylon tubing T P.260	Soft nylon tubing TS P.263	Polyurethane tubing TU P.265	Soft polyurethane tubing TUS P.267
Flat tubing TU, TUS, TUZ P.276	Moisture Control Tube IDK P.282	FR soft nylon tubing TRS P.285	FR double layer tubing TRB P.287
Antistatic tubing TA□ P.295	Fluoropolymer tubing TL/TIL P.297	Fluoropolymer tubing (PFA) TLM/TILM P.299	FEP tubing (Fluoropolymer) TH/TH P.303
Tube cutter TK P.311	Tube releasing tool TG P.312	Tube stand & Tube reel TB/TBR P.312	

Blow Guns

Blow gun VMG P.315	Nozzles for blowing KN P.320
------------------------------	--

Rotary One-touch fittings KS/KX P.76	One-touch fittings manifold KM P.78	Insert fittings KF P.81	Miniature fittings M P.85
S couplers KK130 P.101	Multi-connector DM P.103	Multi-connector with One-touch fittings DMK P.105	Rectangular multi-connector KDM P.107
Antistatic One-touch fittings KA P.125	Stainless steel 316 One-touch fittings KQG2 P.128	Stainless steel One-touch fittings KG P.133	Stainless steel 316 insert fittings KFG2 P.140
Fluoropolymer fittings LQ1 P.156	Fluoropolymer fittings/Flare type LQ3 P.172	Bore through connector LQHB P.183	

In-line type Speed controller with indicator AS-FS P.198	Elbow/Universal type AS□□□1F P.199	Flame resistant/ Elbow type P.203 AS□□□1F-W2	Plug-in type AS□□□□P P.205
With residual pressure release valve Elbow/Universal type AS□□□1FE P.221	Panel mount type AS□1F-3 P.212	In-line, Centralised piping type AS-DPP00092/00093 P.213	Dual speed controller ASD□30F P.214
With Indicator/Stainless steel/ Elbow type, Push-lock type AS-FSG P.225	Stainless steel Elbow/Universal type AS□□□1FG P.227	Stainless steel/In-line type Push-lock type AS-FG P.229	With Indicator/Stainless steel/ In-line type, Push-lock type AS-FSG P.230
Low speed operation Elbow/Universal type AS□□□1FM P.237	Low speed operation In-line type AS□1FM P.239	Low speed operation Dual speed controller ASD□30FM P.240	Adjustable by flat head screwdriver Elbow/Universal type AS□□□1F-D P.241
Tamper proof dual speed controller ASD□30F-T P.248	With pilot check valve ASP□30F P.249	Speed exhaust controller ASV P.250	Air saving speed controller AS-R/AS-Q P.251
Metering valve with silencer ASN2 P.255	Quick exhaust valve AQ□F P.255	Bushing type check valve AKH/AKB P.256	Check Valve INA/XTO P.256

Hard polyurethane tubing TUH P.269	Wear resistant tubing TUZ P.271	Polyurethane coil tubing TCU P.273	Polyurethane flat tubing TFU P.275
Double layer tube stripper TKS P.288	FR double layer polyurethane tubing TRBU P.289	FR three-layer polyurethane tubing TRTU P.291	2-layer soft fluoropolymer tubing TQ P.293
Soft fluoropolymer tubing (Modified PTFE) TD/TID P.305	Polyolefin tubing TPH P.307	Soft polyolefin tubing TPS P.309	Multi-tube holder TM P.311

Silencers

Compact resin type/Male thread AN05 to 40 P.321	Compact resin type/One-touch fitting connection AN10 to 30-C P.321	Metal body type AN□00 P.322	Metal case type 25□□ P.322
BC sintered body type AN1□□-□ P.323	High noise reduction type AN□02 P.323	40 dB (A): High noise reduction type ANA1 P.324	38 dB (A): High noise reduction type ANB1 P.324

Fittings

General Purposes

One-touch Fittings

KQ2

P.36



New! Oval type release button added!

Face Seal One-touch Fittings

KQ2

Thread connection R, Rc

P.50

Thread connection G

P.58



Uni One-touch Fittings

KQ2

P.63

Uni thread

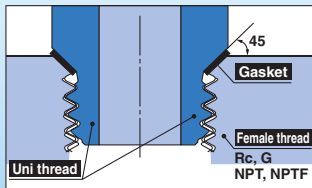

Metal One-touch Fittings

KQB2

Heat Resistant

Spatter Proof

P.68

Brass Nickel Plated

P.73



Rotary One-touch Fittings

KS/KX

P.76

Rotation



One-touch Fittings Manifold

KM

P.78



Insert Fittings

KF

Heat Resistant*

Spatter Proof*

P.81

* Brass sleeve



Resin sleeve



Brass sleeve

Miniature Fittings

M

P.85

Miniature

For ø2 tube



Self-align Fittings

H, DL, L, LL

Spatter Proof

P.90

Applicable for use on soft copper steel pipe



Self-seal Fittings

KC

P.93

Before insertion of tubing

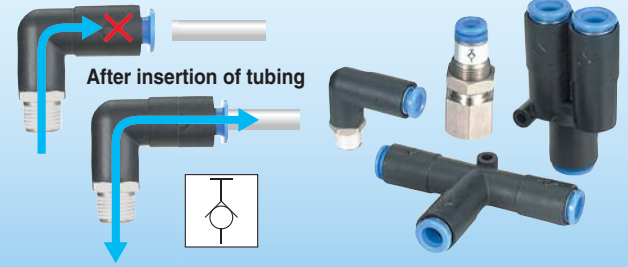

S Couplers

KK

P.96

With sleeve lock (Except for KK2)

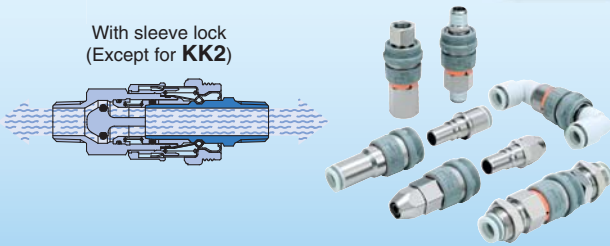

S Couplers

KKH

P.99

Without sleeve lock



S Couplers

KK130

P.101

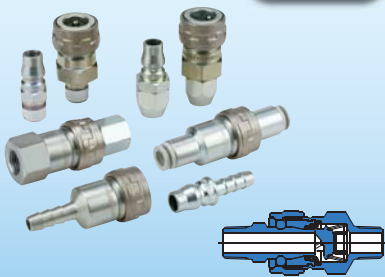

Multi-connector

DM

P.103

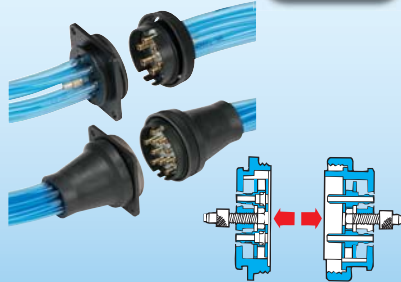

Multi-connector with One-touch Fittings

DMK

P.105

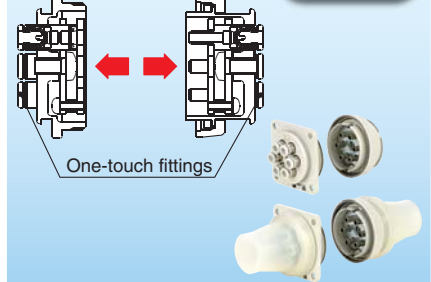

Rectangular Multi-connector

KDM

P.107

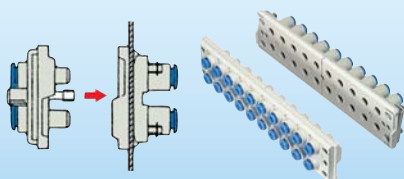

Rotary joint

MQR

P.109



Piping Module

KB

P.113

One-touch connection and release



Fittings

Special Environments

Spatter Proof

FR One-touch Fittings

KR-W2

P.118

Flame resistant



FR One-touch Fittings Manifold

KRM

P.123

Flame resistant



Corrosion Resistant

Stainless Steel 316 One-touch Fittings

KQG2

P.128

Heat Resistant

Stainless steel 316



Stainless Steel One-touch Fittings

KG

P.133

Stainless steel 303



Stainless Steel 316 Insert Fittings

KFG2

P.140

Heat Resistant

Stainless steel 316



Stainless Steel Miniature Fittings

MS

P.143

Stainless steel 316



S Couplers

KKA

P.146

Heat Resistant

Stainless steel 304



Antistatic Measures

Antistatic One-touch Fittings

KA

P.125

Spatter Proof

Antistatic

Flame resistant



Heat Resistant

Fluoropolymer Fittings
LQ1 p. 156
New PFA
Clean
Corrosion Resistant

Fluoropolymer Fittings
LQ3 p. 172
New PFA
Clean
Corrosion Resistant

Fluoropolymer Bore Through Connector
LQHB p. 183
New PFA
Clean
Corrosion Resistant

Clean room

Clean

Clean One-touch Fittings
KP P.150
Clean room blowing/washing lines

Clean One-touch Fittings
KPQ/KPG P.153
Drive system air piping

Clean Series: One-touch Fittings
10-KQ2 P.48

Clean Series: Insert Fittings
10-KF P.84

Clean Series: Miniature Fittings
10-M/MS P.89, 145
10-M
10-MS

Clean Series: Rectangular Multi-connector
10-KDM P.108

Clean Series: Stainless Steel
10-KG P.139

Speed Controller with One-touch Fitting

General Purposes

Elbow/Universal Type

AS□□□1F-A

P.191, 193

Push-lock type



With Indicator, Elbow/Universal Type

AS□□□1FS

P.196

Push-lock type



In-line Type

AS□□□2F-A

P.195

Push-lock type



With Indicator/In-line Type

AS□□□2FS

P.198

Push-lock type



Elbow/Universal Type

AS□□□1F

P.199

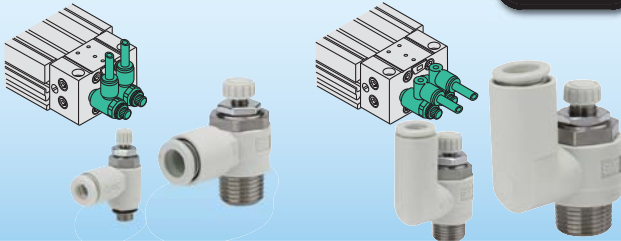

Plug-in Type

AS□□□□P

P.205



In-line Type

AS□□□2F

P.211



In-line/Panel Mount Type

AS□□□1F-3

P.212



Centralised Piping Type

AS-DPP00092/00093

P.213

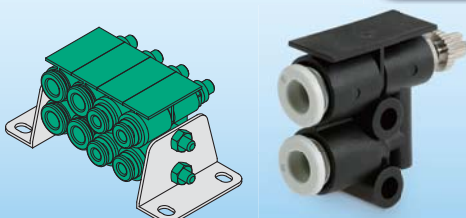

Dual Speed Controller

ASD□30F

P.214

Lurch prevention/Control of single acting cylinder

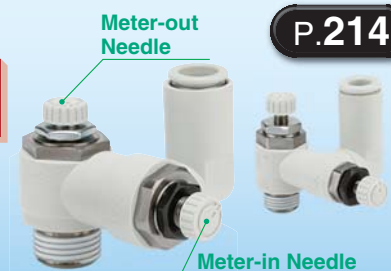

General Purposes

With Uni One-touch Fitting

AS□□□1F-U□-A

P.215

Push-lock type



With Indicator/Uni Thread Type

AS□2□1FS-U□

P.217



With Uni One-touch Fitting

AS□□□1F-U□

P.219

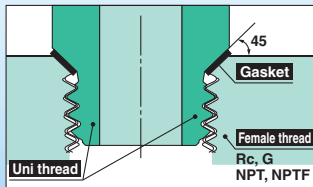

Low Speed Operation

Elbow/Universal Type

AS□□□1FM

P.237

Low speed control at 10 to 50 mm/sec



In-line Type

AS□1FM

P.239



Dual Type

ASD□30FM

P.240

Low speed control of small bore cylinders.



Special Environments

Spatter Proof

Flame Resistant Elbow Type

AS□2□1F-W2

P.203

Flame resistant resin



With One-touch Fitting/Elbow Type (Metal body)

AS□2□1-F

P.207

Metal body,
Flame resistant resin (fittings)



All Metal Exterior/Elbow Type

AS-X737

P.210



Flame Resistant/Elbow Type

AS□2□1F-W2D

P.209

Screw driver operation type



Special Environments

Corrosion Resistant

Elbow/Universal Type

AS□□□1FG-A P.223

Push-lock type



Stainless steel 303

With Indicator/Elbow/Universal Type

AS□□□1FSG P.230

Push-lock type



Stainless steel 303

Elbow/Universal Type

AS□□□1FG P.227



Stainless steel 303

In-line Type

AS□□□2FG-A P.229

Stainless steel 303



With Indicator/In-line Type

AS□□□2FSG P.230

Stainless steel 303



In-line Type

AS□1FG P.231

Stainless steel 303



Dual Type

ASD□30FG P.232

Stainless steel 303



Elbow Type

ASG P.233

Stainless steel 316



Speed Controller with One-touch Fitting

Special Environments

Clean

Clean Speed Controller

AS□2□1FPQ/FPG

P.235

Clean room



Clean Series

10-AS

Clean room



		Elbow	Universal	In-line
General purposes Push-lock	10-AS	P.192	P.192	
General purposes/ With indicator/Push-lock	10-AS-FS	P.197		
General purposes	10-AS□□□1F	P.201	P.201	
Dual	10-ASD□30F		P.214	
Stainless steel Push-lock	10-AS-FG	P.224	P.224	
Stainless steel/ With indicator/Push-lock	10-AS-FSG	P.226		
Stainless steel	10-AS□□□1FG	P.228	P.228	P.231
Stainless steel Dual	10-ASD-FG		P.232	
Low speed operation	10-AS-FM	P.238	P.238	P.238
Low speed operation Dual	10-ASD-FM		P.240	

With Special Function

Residual Pressure Exhaust

Elbow/Universal Type

AS□□□1FE

P.221

Residual pressure exhaust

Release
Push
Release



Drop Prevention

Speed Controller with Pilot Check Valve with One-touch Fitting

ASP□30F

P.249

Drop prevention,
Emergency stop

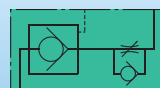

Quick Exhaust

Speed Exhaust Controller

ASV

Spatter Proof*

P.250

* ASV310F/410F/510F

High-speed
cylinder operation



Air Saving

Air Saving Speed Controller

AS-R/AS-Q P.251

Air Saving Valve

ASR/ASQ

Push-Lock Type

P.252

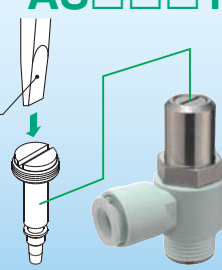
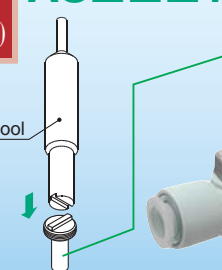

Tool Operation Type

Elbow/Universal Type		In-line Type	Dual Type
Screwdriver operation type  <p>Flat head screwdriver</p>	AS□□□1F-D P.241	AS□1F-D P.243	ASD□30F-D P.244 Lurch Prevention
	Tamper proof (Special tool operation type)  <p>Special tool</p>	AS□□□1F-T P.245	AS□1F-T P.243

Related Equipment

Holder TMH P.254 For securing a speed controller/In-line type 	Residual Pressure Release Valve with One-touch Fittings KE□ P.254 	Multi-holder TMA P.254 For securing the KE series or KQ2L/T/H 	Metering Valve with Silencer ASN2 P.255 
Quick Exhaust Valve AQ□F P.255 	Check Valve with One-touch Fittings AKH/AKB P.256 	Check Valve INA/XTO P.256 Body material: Brass/ Stainless steel 	

Tubing

General Purposes

Polyurethane Tubing

TU

P.265

29 colour variations



Black	White	Red	Blue	Yellow	Green	Clear	Orange	Solid blue	Clear blue
Medium blue	Brown	Solid green	Clear green	Neon green	Dark green	Grey	Light grey	Neon pink	Solid purple
Clear purple	Solid red	Clear red	Silver	Solid yellow	Clear yellow	Neon yellow	Clear orange	Neon orange	

Nylon Tubing

T

P.260



Black	White	Red	Blue	Yellow	Green
-------	-------	-----	------	--------	-------

Soft Nylon Tubing

TS

P.263



Black	White	Red	Blue	Yellow	Green
-------	-------	-----	------	--------	-------

Soft Polyurethane Tubing

TUS

P.267

Extremely flexible tubing



Black	White	Red	Blue	Yellow	Green
Yellow brown	Translucent				

Hard Polyurethane Tubing

TUH

P.269



Black	Blue	Translucent	White
-------	------	-------------	-------

Wear Resistant Tubing

TUZ

P.271

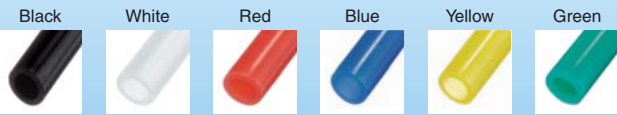

Polyurethane Coil Tubing

TCU

P.273

Coil

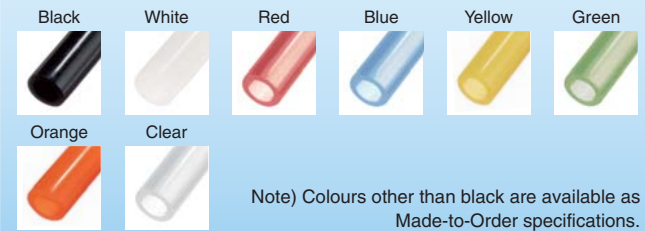
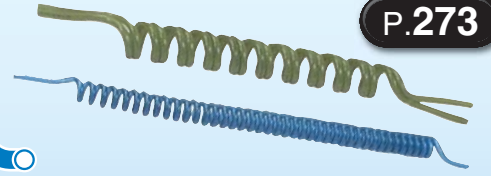

Polyurethane Flat Tubing

TFU

P.275

Flat



Flat Tubing

**TU
TUS
TUZ**

P.276

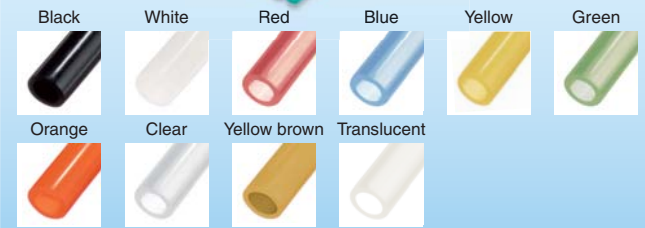

Special Environments

Condensation Prevention

Fluoropolymer Tubing

IDK Moisture Control Tube

P.282



Linear & Coil shape

Translucent

Spatter Proof

FR Soft Nylon Tubing

TRS

P.285

Flame resistant



FR Double Layer Tubing

TRB/TRBU

P.287, 289

Flame resistant

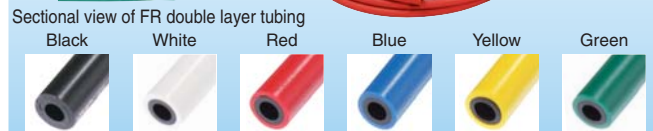
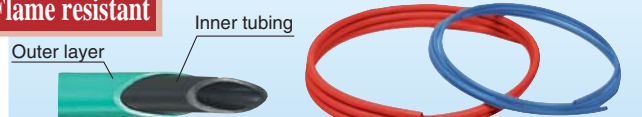

Tubing

Special Environments

Spatter Proof

FR Three-layer Polyurethane Tubing

TRTU

P.291

Flame resistant

Outer layer: Flame resistant polyolefin
 Three-layer design
 Middle layer: Aluminum laminated film
 Inner tube: Polyurethane

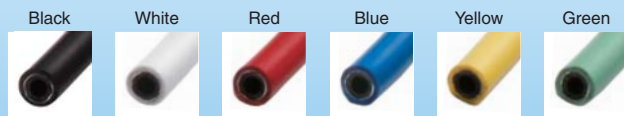

Double Layer Tube Stripper

TKS

P.288

A tool for stripping off outer tube layers

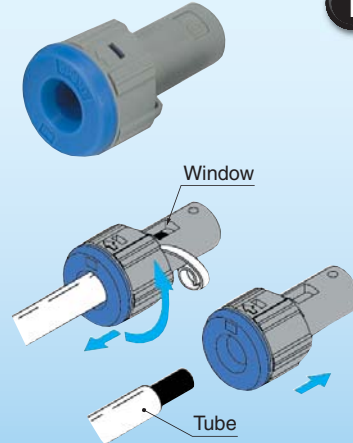

Heat Resistant

Fluoropolymer Tubing

TL/TIL

P.297

Super PFA

Corrosion Resistant

Clean



Fluoropolymer Tubing

TLM/TILM

P.299, 301

PFA

Corrosion Resistant

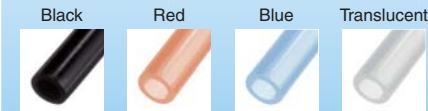

FEP Tubing (Fluoropolymer)

TH/TIH

P.303

FEP

Corrosion Resistant



Soft Fluoropolymer Tubing

TD/TID

P.305

Modified PTFE

Corrosion Resistant



Heat Resistant

2-layer Soft Fluoropolymer Tubing

TQ

P.293

Special fluoropolymer (Inner layer)
Special nylon resin (Outer layer)

Corrosion Resistant

Translucent



Antistatic Measures

Antistatic Tubing

TAS/TAU

P.295, 296

Antistatic Measures



Black

White

Blue

Green

Clear



Note) Colours other than black are available as Made-to-Order specifications.

Clean

Clean Series

10-TU

P.266

Clean room



Black

White

Red

Blue

Yellow

Green



Orange

Clear



Clean Series

10-TCU/10-TFU

10-TFU

P.273

Clean room



Black

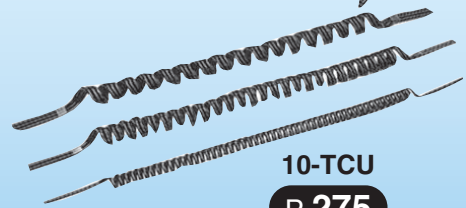

10-TCU
P.275

Clean Tubing

TPH/TPS

P.307, 309

Polyolefin

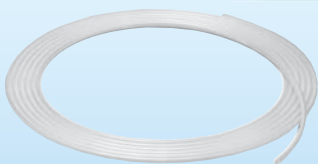

Black

White

Red

Blue

Yellow

Green



Tubing

Related Products

Multi-tube Holder

TM



P.311

Tube Cutter

TK



P.311

Tube Releasing Tool

TG



P.312

Tube Stand

TB

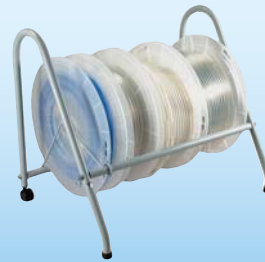

P.312

Tube Reel

TBR



P.312

Blow Guns/Silencers

Blow Gun
VMG



P.315

Nozzles for Blowing
KN



P.320

Compact Resin Type/Male Thread
AN05 to 40



P.321

Compact Resin Type/One-touch Fitting Connection
AN10 to 30-C



P.321

Metal Body Type
AN□00



P.322

Metal Case Type
25□□



P.322

BC Sintered Body Type
AN1□□-□

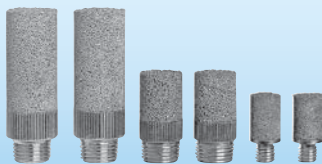

P.323

High Noise Reduction Type
AN□02



P.323

High Noise Reduction Type
ANA1

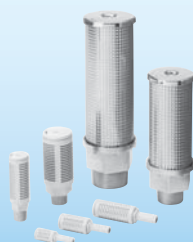

P.324

High Noise Reduction Type
ANB1



P.324

Piping Equipment Applications/Themes List

Applications/ Themes	Clean Low particulate generation	Corrosion Resistant Stainless steel Fluoropolymer	Heat Resistant Metal Fluoropolymer	Antistatic Measures Antistatic	Low Speed Control 10 to 50 mm/s	Residual Pressure Exhaust Residual pressure release
Fittings	<p>For blowing</p> <ul style="list-style-type: none"> •KP(P.150) <p>Drive system air piping</p> <ul style="list-style-type: none"> •KPQ/KPG(P.153) •LQ1(P.156) •LQ3(P.172) <p>Clean series</p> <ul style="list-style-type: none"> •10-series (P.4) 	<ul style="list-style-type: none"> •KQG2(P.128) •KG(P.133) •KFG2(P.140) •MS(P.143) •KKA(P.146) •LQ1(P.156) •LQ3(P.172) 	<ul style="list-style-type: none"> •KQB2(P.73) •KF(P.81) (Brass sleeve) •KQG2(P.128) •KFG2(P.140) •KKA(P.146) •LQ1(P.156) •LQ3(P.172) 	<ul style="list-style-type: none"> •KA(P.125) 		
Speed Controller with One-touch Fitting	<p>Clean speed controllers</p> <ul style="list-style-type: none"> •AS-FPQ/FPG (P.235) <p>Clean series</p> <ul style="list-style-type: none"> •10-series (P.9) 	<ul style="list-style-type: none"> •AS-FG (P.223 or after) (Elbow/Universal/In-line) •ASD-FG(P.232) (Dual) •ASG(P.233) 		<ul style="list-style-type: none"> •AS-F-X260(P.220) 	<ul style="list-style-type: none"> •AS-FM (P.237 or after) (Elbow/Universal/In-line) •ASD-FM(P.240) (Dual) 	<ul style="list-style-type: none"> •AS-FE(P.221) (Elbow/Universal)
Tubing	<ul style="list-style-type: none"> •TL/TIL (P.297) <p>Clean series</p> <ul style="list-style-type: none"> •10-series (P.14) <p>Clean tubing</p> <ul style="list-style-type: none"> •TPH/TPS (P.307, 309) (Polyolefin) 	<ul style="list-style-type: none"> •TL/TIL (P.297) •TLM/TILM (P.299) •TH/THI (P.303) •TD/TID (P.305) •TQ (P.293) 	<ul style="list-style-type: none"> •TL/TIL (P.297) •TLM/TILM(P.299) •TH/THI (P.303) •TD/TID (P.305) •TQ (P.293) 	<ul style="list-style-type: none"> •TAS (P.295) •TAU (P.296) 		
Others		<p>Check valve</p> <ul style="list-style-type: none"> •INA(P.256) (Stainless steel) 	<p>Check valve</p> <ul style="list-style-type: none"> •XTO(P.256) 			<p>Residual pressure release valve</p> <ul style="list-style-type: none"> •KE□(P.254) (With One-touch fitting)

	Drop Prevention	Lurch Prevention	Spatter Proof	Quick Exhaust	Oil Free	
	Pilot check	Meter-in/Meter-out control	Flame resistant resin Metal	Quick exhaust	No lubricant	Vaseline applied
			<ul style="list-style-type: none"> •KQB2(P.73) •KF(P.81) (Brass sleeve) •H/DL/L/LL(P.90) •KR-W2(P.118) •KRM(P.123) (Manifold) •KA(P.125) 		<ul style="list-style-type: none"> Grease-free •KQB2(P.73) •KF(P.81) (Insert) •M(P.85) (Miniature) (Except M-5UN) •H/DL/L/LL(P.90) (Self-align) •KQG2(P.128) •MS(P.143) (Miniature/Stainless steel) (Except MS-5UN) •KKA(P.146) •KP(P.150) (Clean fitting) •LQ1(P.156) •LQ3(P.172) Made to Order* •X17(P.25, 26) (Fluorine coating) •X29(P.25, 26) (Fluorine coating +Electroless nickel plated) 	<ul style="list-style-type: none"> Made to Order* •X12(P.27, 28) (Vaseline)
	<ul style="list-style-type: none"> •ASP-F(P.249) 	Dual speed controller <ul style="list-style-type: none"> •ASD-F(P.214) •ASD-FG(P.232) (Stainless steel) •ASD-F-D(P.244) (Flat head screwdriver operation) •ASD-F-T(P.248) (Tamper proof) 	<ul style="list-style-type: none"> •AS-F(P.199) (With One-touch fitting/ Elbow type (Metal body)) •AS-F-W2(P.203) (Flame resistant/ Elbow type) •ASV310F 410F/510F(P.250) (Speed exhaust controller) 	Speed exhaust controller <ul style="list-style-type: none"> •ASV-F(P.250) 		<ul style="list-style-type: none"> Made to Order* •X12(P.27, 28) (Vaseline)
			<ul style="list-style-type: none"> •TRS(P.285) •TRB/TRBU(P.287 289) (Double layer) •TRTU(P.291) (Three-layer) 			
	Check valve <ul style="list-style-type: none"> •AKH/AKB(P.256) (With One-touch fitting) 			Quick exhaust valve <ul style="list-style-type: none"> •AQ-F(P.255) (With One-touch fitting) 		

* For models applicable to made-to-order, refer to "Made to Order".

Low particulate generating type designed for use in clean rooms

Clean



Clean Series (10-series)

- Double package
- Metal: Nickel plated
- Fluorine-based grease

Drive air piping system

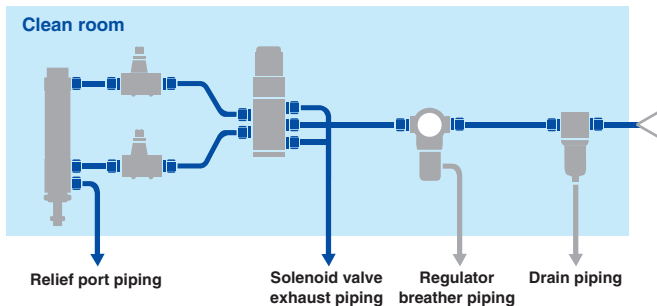

Clean One-touch Fittings and Tubing

- Completely oil-free
- Liquid-contact areas are non-metallic
- Double package

Clean blowing system

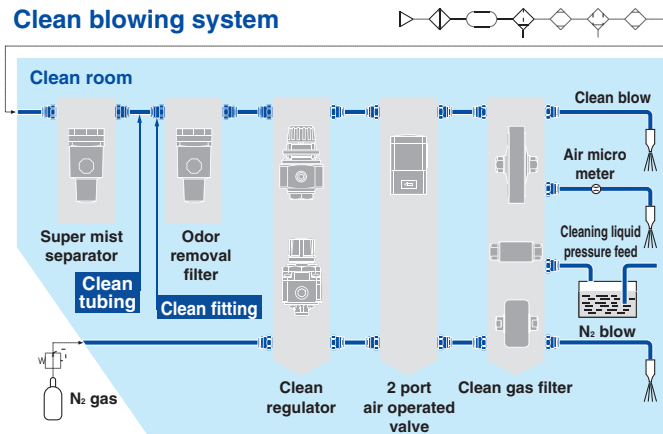

■ Clean series (10-series)

Speed controller with One-touch fitting **10-AS** P.9

Polyurethane tubing **10-TU**
10-TCU
10-TFU P.14

One-touch fittings **10-KQ2** P.48
P.67

Insert fittings **10-KF** P.84

Miniature fittings **10-M** P.89
10-MS P.145

Rectangular multi-connector **10-KDM** P.108

■ Clean One-touch fittings and tubing

Clean One-touch fittings **KP** P.150

Clean One-touch fittings **KPQ**
KPG P.153

Polyolefin tubing **TPH** P.307
TPS P.309

■ Clean speed controller

Clean speed controller **AS-FPQ**
AS-FPG P.235

■ Fluoropolymer Fittings **LQ1** P.156

Fittings **LQ3** P.172

Tube (Super PFA) **TL/TIL** P.297

Stainless steel/Fluoropolymer specification with corrosion resistance

Corrosion Resistant



- **Metal parts**
Stainless steel 316 (MS, KQG2, KFG2, ASG)
Stainless steel 304 (KKA)
Stainless steel 303 (KG, AS-FG, ASD-FG)
- Prevents rust, discolouration and the generation of copper ions.
- **Applications:** Food processing equipment, CRT production lines, etc.

- **Related Equipment**
Stainless steel cylinder
• Series CJ5/CG5



- **Made to Order**

Symbol	Stainless steel parts
XB12	External stainless steel cylinder
XC6	Piston rod, Rod end nut
XC7	Tie-rod, Tie-rod nut, Cushion valve
XC27	Split pins for double clevis pin, Double knuckle joint pin

■ Tubing

Fluoropolymer (Super PFA)  **TL/TIL** P.297

Fluoropolymer (PFA)  **TLM/TILM** P.299
301

FEP  **TH/THH** P.303

Soft fluoropolymer  **TD/TID** P.305

2-layer soft fluoropolymer tubing  **TQ** P.293

■ Fittings

One-touch  **KQG2** P.128

One-touch  **KG** P.133

Insert fittings  **KFG2** P.140

Miniature  **MS** P.143

S couplers  **KKA** P.146

Fluoropolymer  **LQ1** P.156

Fluoropolymer  **LQ3** P.172

Bore through connector  **LQHB** p. 183

■ Speed controller with One-touch fitting

Elbow type  **AS□2□1FG-A** P.223
Push-lock type

With indicator/Elbow type  **AS□2□1FSG** P.230
Push-lock type

Elbow type  **AS□2□1FG** P.227

Universal type  **AS□3□1FG-A** P.223
Push-lock type

Universal type  **AS□3□1FG** P.227

In-line  **AS□0□1FG** P.231

Dual  **ASD□30FG** P.232

Elbow type  **ASG** P.233

■ Check valve

Stainless steel  **INA** P.256

Metal or fluoropolymer specification

Heat Resistant



■ Fittings

Metal One-touch  **KQB2** P.73

Brass sleeve Insert  **KF** P.81

Stainless steel One-touch  **KQG2** P.128

Stainless steel Insert  **KFG2** P.140

S couplers  **KKA** P.146

Fluoropolymer  **LQ1** P.156

Fluoropolymer  **LQ3** P.172

Bore through connector  **LQHB** p. 183

- **Operating temperature (Max)/Material**
- KQB2:** 150 °C/Brass, Stainless steel 304, Stainless steel 316, Special FKM
- KF** : 150 °C/Brass
- KQG2:** 150 °C/Stainless steel 316, Special FKM
- KFG2:** 260 °C (Note)/Stainless steel 316
- KKA** : 150 °C/Stainless steel 304, Fluororubber
- LQ1** : 150 °C/New PFA
- LQ3** : 200 °C/New PFA
- TH/THI:** 200 °C/FEP
- TL/TIL:** 260 °C/Super PFA
- TLM/TILM:** 260 °C/PFA
- TD/TID:** 260 °C/Modified PTFE
- TQ** : 100 °C (Air, Inert gas): Special fluoropolymer (Inner layer)/Special nylon resin (Outer layer)
: 70 °C (Water, Solvent): Special fluoropolymer (Inner layer)/Special nylon resin (Outer layer)

* Varies depending on the operating pressure. Be sure to confirm the catalogue.
Note) Swivel elbow and with sealant types: -5 to 150 °C

■ Check valve

 **XTO** P.254

■ Tubing

Fluoropolymer (Super PFA)  **TL/TIL** P.297

Fluoropolymer (PFA)  **TLM/TILM** P.299 301

FEP  **TH/THI** P.303

Soft fluoropolymer  **TD/TID** P.305

2-layer soft fluoropolymer tubing  **TQ** P.293

Antistatic Measures

Prevents charge of static electricity



- **Conductive resin is used.**
- **Surface resistance: 10^4 to $10^7 \Omega$**
- **Applications: Semiconductor manufacturing, etc.**
- **Uni thread construction that does not require sealant enables grounding.**

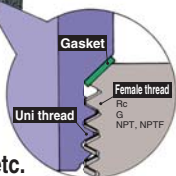

■ One-touch fittings

Antistatic  **KA** P.125

■ Speed controller with One-touch fitting

Elbow  **AS□2□1F-X260** P.220

■ Tubing

Antistatic  **TAS TAU** P.295 P.296

Suitable for controlling the speed of low speed cylinders

Low Speed Control

Low speed actuation



- Effective area of controlled flow: 1/10 (Compared to standard type)
- Needle rotations: 10 to 20 turns
- The dual type speed controller is suitable for cylinders with a small bore size.

Related equipment

CJ2X-Z



CQSX



CM2X-Z



Low speed cylinder

Model	Minimum operating piston speed
CJ2X-Z	1 mm/s
CUX	10, 16: 1 mm/s, 20, 25, 32: 0.5 mm/s
CQSX	12, 16: 1 mm/s, 20, 25: 0.5 mm/s
CQ2X	0.5 mm/s
CM2X-Z	0.5 mm/s

Speed controller with One-touch fitting

Low speed operation:
Elbow type



AS□2□1FM P.237

Low speed operation:
Universal type



AS□3□1FM P.237

Low speed operation:
In-line type



AS□0□1FM P.239

Low speed operation:
Dual type



ASD□30FM P.239

Prevents accidents caused by residual pressure

Residual Pressure Exhaust

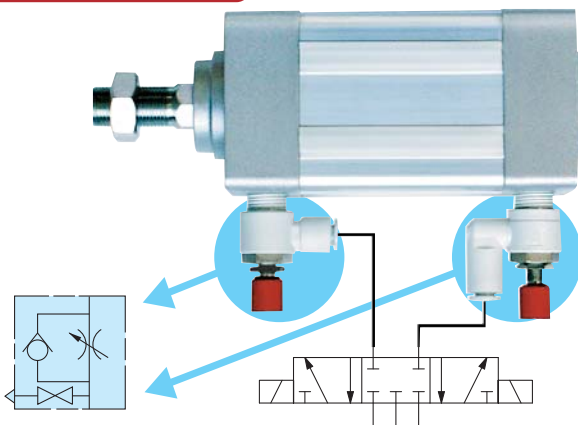

- Integrates a speed controller and a residual pressure release valve.
- Residual pressure can be easily released with one push of button.



Speed controller with One-touch fitting

With residual pressure release valve:
Elbow type



AS□2□1FE P.221

With residual pressure release valve:
Universal type



AS□3□1FE P.221

Related equipment

Residual pressure release valve with One-touch fittings



KE□ P.254

Drop prevention and emergency stops are possible.

Drop Prevention

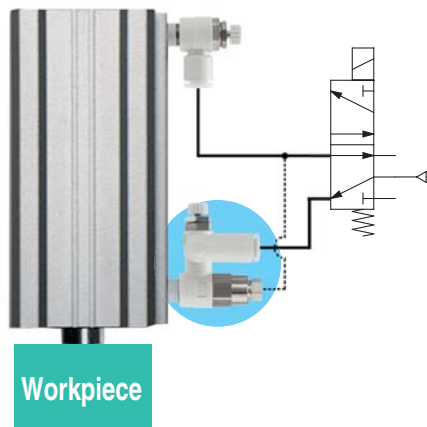

- Pilot check valve and speed controller are combined.

■ Speed controllers with One-touch fitting

With pilot check valve

ASP□30F P.249



■ Related equipment

Check valve with One-touch fittings

AKH/ AKB

P.254



Prevents sudden extensions with meter-in/meter-out control.

Lurch Prevention

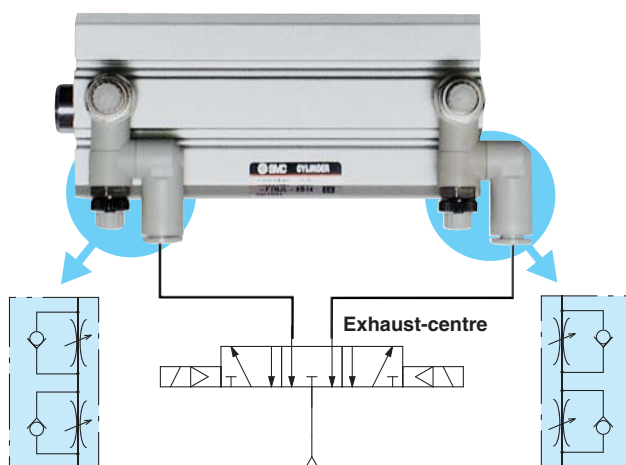

- Two flow control valves and check valves have been integrated.
- Other applications: Speed control of single acting cylinders.

■ Speed controllers with One-touch fitting

Dual

ASD□30F P.214



Stainless steel: Dual

ASD□30FG P.232



Low speed operation: Dual type

ASD□30FM P.240



Adjustable by flat head screwdriver: Dual

ASD□30F-D P.244



Tamper proof: Dual

ASD□30F-T P.248



Can be used in environments exposed to spatters from spot welding.

Spatter Proof

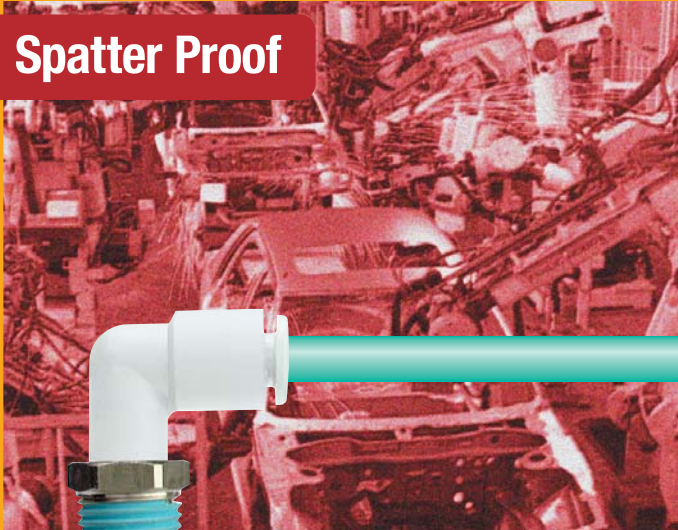

● **Flame resistance**
(Equivalent to UL-94 standard V-0)

● **Double layer tubing**

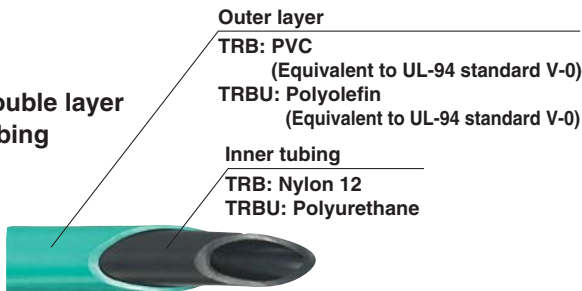

■ **Application: Spot welding**

● **Three-layer tubing**



■ **Fittings**

Metal One-touch  **KQB2** P.73

Brass sleeve Insert  **KF** P.81

Self-align  **H,DL,L,LL** P.90

FR One-touch  **KR-W2** P.118

Manifold  **KRM** P.123

Antistatic  **KA** P.125

■ **Speed controllers with One-touch fitting**

Elbow  **AS□2□1F-W2** P.203

Elbow (Metal body)  **AS□2□1-F** P.207

Speed exhaust controller  **ASV** P.250

■ **Tubing**

FR soft nylon tubing  **TRS** P.285

FR double layer tubing  **TRB** P.287
TRBU P.289

FR three-layer polyurethane tubing  **TRTU** P.291

■ **Related equipment**

Double layer tube stripper  **TKS** P.288

Piping Equipment **Made to Order**













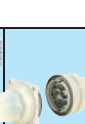
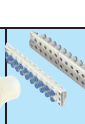

Fittings

Specifications												
		One-touch	Uni One-touch	Metal One-touch	Rotary (Standard)	Rotary (High speed)	Manifold	Insert	Miniature	Self-align	Self-seal	S couplers
		P.36	P.58	P.73	P.76	P.76	P.78	P.81	P.85	P.90	P.93	P.96
		KQ2	KQ2	KQB2	KS	KX	KM	KF	M	H,DL L,LL	KC	KK
X17	Grease-free, Rubber material: NBR (Fluorine coating)	Note 9) (X17)					X17	Standard	Note 1) Standard	Standard		
X29	Grease-free, Rubber material: NBR (Fluorine coating), Copper-free (With electroless nickel plated)	Note 9) (X29)					X29					
X39	Grease-free, Rubber material: NBR (Fluorine coating), Clean	Note 9) (X39)										
X94	Grease-free, Rubber material: FKM (Fluorine coating)	Note 9) (X94)		Standard			X94					
X2	Copper-free (With electroless nickel plated)	Note 11) Standard	Note 11) Standard	Standard	Standard	Standard	X2	X2	Note 3) Standard	X2	Standard	Standard
X12	Lubricant: White vaseline	X12	X12				X12					
X34	Rubber material: FKM	Note 9) (X34)					X34					
Note 10) X35	Body colour: Black	Note 10) (X35)	Note 10) (X35)									
Note 4) X41	With fixed throttle	Note 9) (X41)										
X83	Gasket material: Stainless steel 304, NBR								X83			
Note 7) X226	Gasket material: Stainless steel 304, FKM								X226			
Note 8) X112	Gasket material: Stainless steel 316, Special FKM								X112			
X70	Liquid-contact areas: Plated with fluorine-contained material											
X53	With pipe tape											
X193	Grease-free, Rubber material: EPDM (Fluorine coating), Gasket material: Stainless steel 316, Special FKM ^{Note 5)}											
10-	Clean series	10-	10-					10-	10-			

Note 1) Except M-5UN Note 2) Except MS-5UN Note 3) X2 is compatible with M-5E, M-5ER and M-5M only.

Note 4) Compatible with male elbow and male connector only. Consult SMC separately for the available fixed throttle diameters.

Note 5) M5 thread Note 6) Compatible with products with threads only Note 7) Compatible with M3 thread only

															Symbol
P.99	P.103	P.105	P.107	P.113	P.118	P.125	P.128	P.133	P.140	P.143	P.146	P.150	P.153	P.153	
KKH	DM	DMK	KDM	KB	KR-W2	KA	KQG2	KG	KFG2	MS	KKA	KP	KPQ	KPG	
			X17					X17		Note 2) Standard					X17
															X29
			X39					X39							X39
							Standard	X94	Standard		Standard				X94
Standard	X2	Standard	Standard	Standard	X2	Standard							Standard		X2
Standard			X12					X12							X12
								X34							X34
															Note 10) X35
															Note 4) X41
										X83					X83
															Note 7) X226
										X112					Note 8) X112
											X70				X70
												X53	X53	X53	X53
													Note 6) X193	X193	X193
			10-					10-		10-		Standard	Standard	Standard	10-











Note 8) Compatible with M5 thread only Note 9) Please consult with SMC.









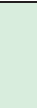



Note 10) The following models are not available as made-to-order: Hexagon socket head male connector/KQ2S, Male connector/KQ2H.

Note 11) Compatible with products without threads as standard, and compatible with products with threads with "N".

Piping Equipment **Made to Order**











Speed Controllers with One-touch Fitting

Specifications													
		Elbow/Universal Push-lock type	With indicator Push-lock type	Elbow/Universal	Elbow Metal body	In-line	Panel mount	Dual	With uni One-touch	With residual pressure release valve	Stainless steel: Elbow/Universal Push-lock type	Stainless steel/With Indicator Push-lock type	
		P.191	P.196	P.198	P.207	P.211	P.212	P.214	P.219	P.221	P.223	P.225	
		AS-F	AS-FS	AS-F	AS-F	AS-F-3	ASD-F	AS-F	AS-FE	AS-FG	AS-FSG		
X12	Lubricant: White vaseline	X12	X12	X12	X12	X12	X12		X12	X12	X12		
X21	Grease-free (Seal: fluorine coating) + Throttle valve (Without check valve)	X21	X21	X21	X21	X21			X21	X21	X21		
X214	Throttle valve (Without check valve)	X214	X214	X214	X214	X214			X214	X214	X214		
X250	Fixed throttle (No needle function)			X250									
X260	Antistatic							X260					
10-	Clean series	10-	10-	10-		10-		10-			10-	10-	

														Symbol
	P.227	P.231	P.232	P.235	P.235	P.237	P.240	P.241	P.244	P.247	P.248	P.249	P.250	
	AS-FG	AS-FG	ASD-FG	AS-FPQ	AS-FPG	AS-FM	ASD-FM	AS-F-D	ASD-F-D	AS-F-T	ASD-F-T	ASP	ASV	
	X12	X12	X12			X12	X12	X12	X12	X12	X12	X12	X12	X12
		X21				X21		X21		X21				X21
	X214	X214				X214		X214		X214				X214
														X250
														X260
	10-	10-	10-	Standard	Standard	10-	10-							10-

Piping Equipment **Made to Order**

Tubing

Specifications												
		Nylon	Soft nylon	Polyurethane	Wear resistant	Polyurethane coil	Polyurethane flat	Antistatic polyurethane	Fluoropolymer	FEP (Fluoropolymer)	Polyolefin	Soft polyolefin
		P.260	P.263	P.265	P.271	P.273	P.275	P.296	P.297	P.303	P.307	P.309
		T	TS	TU	TUZ	TCU	TFU	TAU	TL/ TIL	TH/ TIH	TPH	TPS
X3	Reel	X3	X3	X3			X3					
Note 1) X217	Compatible with food sanitation law			X217								
X4	Change of colour (10 m roll)						X4					
X4	No. of cores (10 m roll, each colour)						X4					
X6	Change of coil turns, Change of colour					X6						
X73	Flat type				X73		X73					
X100	Change of colour, Surface resistance 10 ⁹ Ω							X100				
10-	Clean			10-		10-	10-		Standard		Standard	Standard
Note 1) X64	Reinforced corrugated cardboard specification longer length reel	X64								X64		
Note 1) X192	Coil 2 cores, Multi-colour					X192						
Note 1) X193	Coil 3 cores, Multi-colour					X193						
Note 1) X198	Coil 2 cores, Multi-colour Straight part length selection type					X198						
Note 1) X199	Coil 3 cores, Multi-colour Straight part length selection type					X199						
Note 1) X214	Complies with FDA (Food and Drug Administration)			X214								

Note 1) Please consult with SMC.

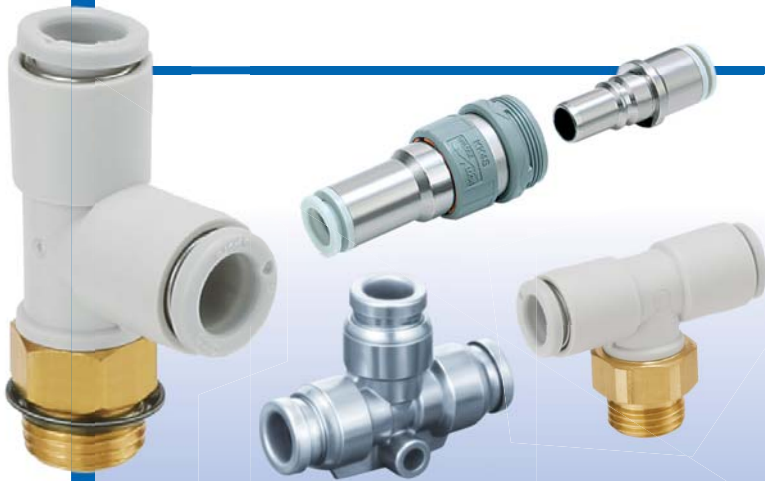

Fittings

P.31

- General Purposes
- Special Environments

Speed Controllers with One-touch Fitting

P.185

- General Purposes
- Special Environments
- Low Speed Control
- Special Environments
- Tool Operation Type



Tubing

P.257

- General Purposes
- Special Environments

Blow Guns

P.314

- Blow Guns
- Nozzles

Silencers



Fittings

General Purpose Fittings Series

One-touch connection and release Possible to use in vacuum to -100 kPa	Applicable tubing material	Applicable tubing O.D. [mm]								Applicable fluid: Temperature [°C]	Page
		Ø 2	Ø 3.2	Ø 4	Ø 6	Ø 8	Ø 10	Ø 12	Ø 16		
One-touch Fittings KQ2 Series Applicable tubing—Metric size	FEP	●	●	●	●	●	●	●	●	Air: -5 to 60 Water: 0 to 40	36
	M5	●	●	●	●	●	●	●	●		
	M6	●	●	●	●	●	●	●	●		
	1/8	●	●	●	●	●	●	●	●		
	1/4	●	●	●	●	●	●	●	●		
	3/8	●	●	●	●	●	●	●	●		
One-touch connection and release Possible to use in vacuum to -100 kPa Face Seal One-touch Fittings KQ2 Series Applicable tubing—Metric size Connection thread: R, Rc, G * Not for connection thread G	Polyurethane	●	●	●	●	●	●	●	●	Air: -5 to 60 Water: 0 to 40	50
	Unions	●	●	●	●	●	●	●	●		
	M3	●	●	●	●	●	●	●	●		
	M5	●	●	●	●	●	●	●	●		
	M6	●	●	●	●	●	●	●	●		
	1/8	●*	●	●	●	●	●	●	●*		
New-stand male thread for piping that reduces the screw-in time by 1/3. Uni One-touch Fittings KQ2 Series Applicable tubing—Metric size	Nylon	●	●	●	●	●	●	●	●	Air: -5 to 60 Water: 0 to 40	58
	1/4	●	●	●	●	●	●	●	●		
	3/8	●	●	●	●	●	●	●	●		
	1/2	●	●	●	●	●	●	●	●		
	Unions	●	●	●	●	●	●	●	●		
	M5	●	●	●	●	●	●	●	●		
Body material: Brass (nickel plated), Stainless steel 316 Release button: Stainless steel 304 Metal One-touch Fittings KQB2 Series Applicable tubing—Metric size	Soft nylon	●	●	●	●	●	●	●	●	Air, Water: -5 to 150	73
	3/8	●	●	●	●	●	●	●	●		
	1/2	●	●	●	●	●	●	●	●		
	Unions	●	●	●	●	●	●	●	●		
	M5	●	●	●	●	●	●	●	●		
	1/8	●	●	●	●	●	●	●	●		
Low-torque rotation style Rotary One-touch Fittings KS Series (Standard) KX Series (High speed) Applicable tubing—Metric size	PFA	●	●	●	●	●	●	●	●	Air: -5 to 60	76
	M6	●	●	●	●	●	●	●	●		
	1/8	●	●	●	●	●	●	●	●		
	1/4	●	●	●	●	●	●	●	●		
	3/8	●	●	●	●	●	●	●	●		
	1/2	●	●	●	●	●	●	●	●		
One-touch connection and release Compact manifold piping possible One-touch Fittings Manifold KM Series Applicable tubing—Metric size	FEP	●	●	●	●	●	●	●	●	Air: -5 to 60 Water: 0 to 40	78
	3/8	●	●	●	●	●	●	●	●		
	Ø 8	●	●	●	●	●	●	●	●		
	Ø 10	●	●	●	●	●	●	●	●		
	Ø 12	●	●	●	●	●	●	●	●		
	Unions	●	●	●	●	●	●	●	●		
Possible to use in vacuum to 1.0 MPa Insert Fittings KF Series Applicable tubing—Metric size	Nylon	●	●	●	●	●	●	●	●	Air (Resin sleeve): -5 to 60 (Brass sleeve): -5 to 150 Water (Resin sleeve): 0 to 60 Steam (Brass sleeve): -5 to 150	81
	1/8	●	●	●	●	●	●	●	●		
	1/4	●	●	●	●	●	●	●	●		
	3/8	●	●	●	●	●	●	●	●		
	1/2	●	●	●	●	●	●	●	●		
	Unions	●	●	●	●	●	●	●	●		
Compact and non-tool connection Miniature Fittings M Series Applicable tubing—Metric size	Denatured PTFE	●	●	●	●	●	●	●	●	Air: -5 to 60 Water: 0 to 40	85
	M3	●	●	●	●	●	●	●	●		
	M5	●	●	●	●	●	●	●	●		
	1/8	●	●	●	●	●	●	●	●		
	Unions	●	●	●	●	●	●	●	●		
	M5	●	●	●	●	●	●	●	●		

Applicable for use on soft copper steel pipe

Self-align Fittings H/DL/L/LL Series



Applicable tubing—Metric size

One-touch connection and release
Built-in self-seal mechanism

Self-seal Fittings KC Series



Applicable tubing—Metric size

Compact with large flow rate

S Couplers KK Series



Super high impact PBT

S Couplers KKH Series



Manufactured by RECTUS AG

S Couplers KK130 Series



One-touch installation and removal of multi-tubes

Multi-connector DM Series



Applicable tubing—Metric size

One-touch installation and removal of multi-tubes

Multi-connector with One-touch fittings DMK Series



Applicable tubing—Metric size

One-touch installation and removal of multi-tubes

Rectangular Multi-connector KDM Series



Applicable tubing—Metric size

Centralised distribution of supply air

Piping Module KB Series









Applicable tubing—Metric size

Applicable tubing material	Applicable tubing O.D. [mm]											Applicable fluid: Temperature [°C]	Page	
	Ø 2	Ø 3.2	Ø 4	Ø 6	Ø 8	Ø 10	Ø 12	Ø 16						
Nylon Soft nylon Soft copper (C1220T-0)	1/8		•	•	•	•	•						Air	90
	1/4		•	•	•	•	•							
	3/8			•	•	•	•							
	1/2				•	•	•							
	Unions													
Nylon Soft nylon Polyurethane	M5		•	•	•	•	•						Air: -5 to 60	93
	1/8		•	•	•	•	•							
	1/4			•	•	•	•							
	3/8				•	•	•							
	1/2					•	•							
	Unions													
Male thread type Female thread type Nut fitting type One-touch fitting type	R Rc Applicable hose I.D./O.D. Ø 3.2 Ø 4 Ø 6 Ø 8 Ø 10 Ø 12 Ø 16	M5	1/8	1/4	3/8	1/2	3/4						Air: -5 to 60 Water: 0 to 40	96
		5 x 8	6 x 9	6.5 x 10	8 x 12	8.5 x 12.5	11 x 16							
Male thread type Female thread type Nut fitting type	R Rc Applicable hose I.D./O.D.	1/8	1/4	3/8	1/2								Air: -5 to 60 Water: 0 to 40	99
		5 x 8	6 x 9	6.5 x 10	8 x 12	8.5 x 12.5								
Male thread type Female thread type Barb fitting type Nut fitting type One-touch fitting type	R Rc Applicable hose size (inch) Applicable hose I.D./O.D.	1/8	1/4	3/8	1/2								Air: -20 to 80 One-touch fitting type Air: -5 to 60	101
		1/4"	1/4"	3/8"	1/2"									
		5 x 8	6 x 9	6.5 x 10	8 x 12	8.5 x 12.5	11 x 16							
				Ø 6	Ø 8	Ø 10	Ø 12							
Nylon Soft nylon Polyurethane	6 tubes 12 tubes		•	•									Air: -5 to 60	103
Nylon Soft nylon Polyurethane	6 tubes 12 tubes	•	•										Air: -5 to 60	105
FEP PFA Nylon Soft nylon Polyurethane	10 tubes 20 tubes	•	•	•	•	•	•						Air: -5 to 60	107
FEP PFA Nylon Soft nylon Polyurethane		•	•	•	•	•	•						Air: -5 to 60	113

KQ2
KQ2 -Uni
KQB2
KS/KX
KM
KF
M
H/DL L/LL
KC
KK
KKH
KK 130
DM
DMK
KDM
MQR
KB
KR -W2
KRM
KA
KQG2
KG
KFG2
MS
KKA
KP
KPQ/KPG
LQ1
LQ3
LQHB

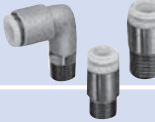
Fittings Series for Special Environments

	Applicable tubing material	Applicable tubing O.D. [mm]	Applicable fluid: Temperature [°C]	Page
		Ø 3.2 Ø 4 Ø 6 Ø 8 Ø 10 Ø 12 Ø 16		
<p>For use where weld spatter is generated. Flame resistant material UL-94 standard V-0</p> <p>FR One-touch Fittings KR-W2 Series</p> <p>Applicable tubing—Metric size</p> 	<p>FR soft nylon</p> <p>FR double layer</p>	<p>1/8</p> <p>1/4</p> <p>3/8</p> <p>1/2</p> <p>Unions</p>	<p>Air: -5 to 60</p> <p>Water: 0 to 60</p>	118
<p>For use where weld spatter is generated. Flame resistant material UL-94 standard V-0</p> <p>FR One-touch Fittings Manifold KRM Series</p> <p>Applicable tubing—Metric size</p> 	<p>FR soft nylon</p> <p>FR double layer</p>	<p>1/4</p> <p>3/8</p> <p>Ø 10</p> <p>Ø 12</p>	<p>Air: -5 to 60</p> <p>Water: 0 to 60</p>	123
<p>For preventing static electricity</p> <p>Antistatic One-touch Fittings KA Series</p> 	<p>Antistatic soft nylon</p> <p>Antistatic polyurethane</p>	<p>M5</p> <p>M6</p> <p>1/8</p> <p>1/4</p> <p>3/8</p> <p>1/2</p> <p>Unions</p>	<p>Air: 0 to 40</p>	125
<p>All stainless steel 316 except seal parts</p> <p>Stainless Steel 316 One-touch Fittings KQG2 Series</p> <p>Applicable tubing—Metric size</p> 	<p>FEP</p> <p>PFA</p> <p>Nylon</p> <p>Soft nylon</p> <p>Polyurethane</p> <p>Polyolefin</p>	<p>M5</p> <p>1/8</p> <p>1/4</p> <p>3/8</p> <p>1/2</p> <p>Unions</p>	<p>Air, Water, Steam:</p> <p>-5 to 150</p>	128
<p>For use in corrosive environments Stainless series</p> <p>Stainless Steel One-touch Fittings KG Series</p> <p>Applicable tubing—Metric size</p> 	<p>FEP</p> <p>PFA</p> <p>Nylon</p> <p>Soft nylon</p> <p>Polyurethane</p>	<p>M5</p> <p>1/8</p> <p>1/4</p> <p>3/8</p> <p>1/2</p> <p>Unions</p>	<p>Air: -5 to 60</p> <p>Water: 0 to 40</p>	133
<p>Certified to meet current Food Sanitation Law standards.</p> <p>Stainless Steel 316 Insert Fittings KFG2 Series</p> <p>Applicable tubing—Metric size</p> 	<p>FEP</p> <p>PFA</p> <p>Denatured PTFE</p> <p>Nylon</p> <p>Soft nylon</p> <p>Polyurethane</p> <p>Polyolefin</p> <p>Soft polyolefin</p>	<p>1/8</p> <p>1/4</p> <p>3/8</p> <p>1/2</p> <p>Unions</p>	<p>Air, Water, Steam:</p> <p>-65 to 260</p> <p>(Swivel elbow and with sealant types: -5 to 150 °C)</p>	140

For use in corrosive environments
Stainless steel 316

Miniature Fittings

MS Series

Applicable tubing—Metric size



Applicable tubing material	Applicable tubing O.D. [mm]							Applicable fluid: Temperature [°C]	Page
	Ø 3.2	Ø 4	Ø 6	Ø 8	Ø 10	Ø 12	Ø 16		
Nylon Soft nylon Polyurethane FEP Denatured PTFE	M5	•	•	•				Air: -5 to 60 Water: 0 to 40	143

Applicable for use on soft copper steel pipe

S Couplers/Stainless Steel Type

KKA Series



Plug	Tubing O.D. [mm]							Applicable fluid: Temperature [°C]	Page		
	1/8	1/4	3/8	1/2	3/4	1	1 1/4			1 1/2	
Male thread type Female thread type	R	•	•	•	•	•	•	•	•	Air, Water: -5 to 150	146
Socket	R	•	•	•	•	•	•	•	•		
Male thread type Female thread type	Rc	•	•	•	•	•	•	•	•		
Male thread type Female thread type	R	•	•	•	•	•	•	•	•		
Male thread type Female thread type	Rc	•	•	•	•	•	•	•	•		

For use in clean room blowing

Clean One-touch Fittings

KP Series



Applicable tubing material	Tubing O.D. [mm]							Applicable fluid: Temperature [°C]	Page
	Ø 3.2	Ø 4	Ø 6	Ø 8	Ø 10	Ø 12	Ø 16		
Polyolefin Soft polyolefin PFA	1/8	•	•	•	•	•	•	Air, Nitrogen, Water (Pure water): -20 to 80	150
	1/4	•	•	•	•	•	•		
	3/8	•	•	•	•	•	•		
	1/2	•	•	•	•	•	•		
Unions	•	•	•	•	•	•	•		

For driving air piping in clean room

Clean One-touch Fittings

KPQ/KPG Series



Applicable tubing material	Tubing O.D. [mm]							Applicable fluid: Temperature [°C]	Page
	Ø 3.2	Ø 4	Ø 6	Ø 8	Ø 10	Ø 12	Ø 16		
Polyurethane : 10-series PFA	M5	•	•	•	•	•	•	Air: -5 to 60	153
	1/8	•	•	•	•	•	•		
	1/4	•	•	•	•	•	•		
	3/8	•	•	•	•	•	•		
	1/2	•	•	•	•	•	•		
Unions	•	•	•	•	•	•	•		

Material: Super PFA

Fluoropolymer Fittings

LQ1 Series



Applicable tubing material	Tubing O.D.														Applicable fluid: Temperature [°C]	Page				
	Metric size [mm]							Inch size [inch]												
	Ø 3	Ø 4	Ø 6	Ø 8	Ø 10	Ø 12	Ø 19	Ø 25	1/8"	3/16"	1/4"	3/8"	1/2"	3/4"			1"	1 1/4"	1 1/2"	
Fluoropolymer tubing	1/8	•	•	•	•	•	•	•	•	•	•	•	•	•	•	•	•	•	Air, Water (Deionised water), Chemical liquids, etc. ^{Note)} : 0 to 200	156
	1/4	•	•	•	•	•	•	•	•	•	•	•	•	•	•	•	•			
	3/8	•	•	•	•	•	•	•	•	•	•	•	•	•	•	•	•	•		
	1/2	•	•	•	•	•	•	•	•	•	•	•	•	•	•	•	•	•		
	3/4	•	•	•	•	•	•	•	•	•	•	•	•	•	•	•	•	•		
	1	•	•	•	•	•	•	•	•	•	•	•	•	•	•	•	•	•		
Unions	•	•	•	•	•	•	•	•	•	•	•	•	•	•	•	•	•	•		

Material: Super PFA

Fluoropolymer Fittings

Flare Type LQ3 Series



Applicable tubing material	Tubing O.D.														Applicable fluid: Temperature [°C]	Page				
	Metric size [mm]							Inch size [inch]												
	Ø 3	Ø 4	Ø 6	Ø 8	Ø 10	Ø 12	Ø 19	Ø 25	1/8"	3/16"	1/4"	3/8"	1/2"	3/4"			1"	1 1/4"	1 1/2"	
Fluoropolymer tubing	1/8	•	•	•	•	•	•	•	•	•	•	•	•	•	•	•	•	•	Air, Water (Deionised water), Chemical liquids, etc. ^{Note)} : 0 to 150 (Nut material PVDF) 0 to 200 (Nut material PFA)	172
	1/4	•	•	•	•	•	•	•	•	•	•	•	•	•	•	•	•			
	3/8	•	•	•	•	•	•	•	•	•	•	•	•	•	•	•	•	•		
	1/2	•	•	•	•	•	•	•	•	•	•	•	•	•	•	•	•	•		
	3/4	•	•	•	•	•	•	•	•	•	•	•	•	•	•	•	•	•		
	1	•	•	•	•	•	•	•	•	•	•	•	•	•	•	•	•	•		
	1 1/4	•	•	•	•	•	•	•	•	•	•	•	•	•	•	•	•	•		
	1 1/2"	•	•	•	•	•	•	•	•	•	•	•	•	•	•	•	•	•		
Unions	•	•	•	•	•	•	•	•	•	•	•	•	•	•	•	•	•	•		

Material: NEW PFA

Fluoropolymer Bore Through Connector

LQHB Series



Applicable tubing material	Tubing O.D.														Applicable fluid: Temperature [°C]	Page				
	Metric size [mm]							Inch size [inch]												
	Ø 3	Ø 4	Ø 6	Ø 8	Ø 10	Ø 12	Ø 19	Ø 25	1/8"	3/16"	1/4"	3/8"	1/2"	3/4"			1"	1 1/4"	1 1/2"	
Fluoropolymer tubing	1/8	•	•	•	•	•	•	•	•	•	•	•	•	•	•	•	•	•	Air, Water (Deionized water), Chemical liquids, etc. ^{*1)} : 0 to 200*1	183
	1/4	•	•	•	•	•	•	•	•	•	•	•	•	•	•	•	•			
	3/8	•	•	•	•	•	•	•	•	•	•	•	•	•	•	•	•	•		
	1/2	•	•	•	•	•	•	•	•	•	•	•	•	•	•	•	•	•		
	3/4	•	•	•	•	•	•	•	•	•	•	•	•	•	•	•	•	•		
	1	•	•	•	•	•	•	•	•	•	•	•	•	•	•	•	•	•		

Note) For details, refer to the WEB catalogue at www.smc.eu

- KQ2
- KQ2-Uni
- KQB2
- KS/KX
- KM
- KF
- M
- H/DL/L/L
- KC
- KK
- KKH
- KK 130
- DM
- DMK
- KDM
- MQR
- KB
- KR-W2
- KRM
- KA
- KQG2
- KG
- KFG2
- MS
- KKA
- KP
- KPQ/KPG
- LQ1
- LQ3
- LQHB

One-touch Fittings



KQ2 Series

■ Applicable tubing O.D. : Metric Size

■ Connection thread : M, R, Rc

One-touch IN/OUT connection.
Possible to use in vacuum
to -100 kPa



New!

Oval type release button added!



Applicable Tubing

Tubing material	FEP, PFA, Nylon, Soft nylon, Polyurethane
Tubing O.D.	Ø 2, Ø 3.2, Ø 4, Ø 6, Ø 8, Ø 10, Ø 12, Ø 16

Note) Oval release button for O.D.: Ø 3, Ø 4, Ø 6

Specifications

Fluid	Air/Water ^{Note 1)}	
Operating pressure range ^{Note 2)}	-100 kPa to 1 MPa	
Proof pressure (at 23 °C)	3 MPa	
Ambient and fluid temperature	-5 to 60 °C, Water: 0 to 40 °C (No freezing)	
Thread	Mounting section	JIS B0203 (Taper thread for piping) JIS B0205 (Metric coarse thread)
	Nut section	JIS B0205 (Metric fine thread)
Seal on the threads	With sealant or none	

Note 1) The surge pressure must be under the maximum operating pressure.

Note 2) Do not use the fittings with a leak tester or for vacuum retention because they are not guaranteed for zero leakage.

Guide

Chuck

Suitable for use with nylon and urethane. Large retaining force.

The chuck provides secure retention and the collet increases the holding force on the tube.

Seal

Can be used for a wide range of pressures from a low vacuum up to a pressure of 1 MPa.

The use of a special profile ensures sealing and reduces resistance when the tube is inserted.

Guide

Chuck





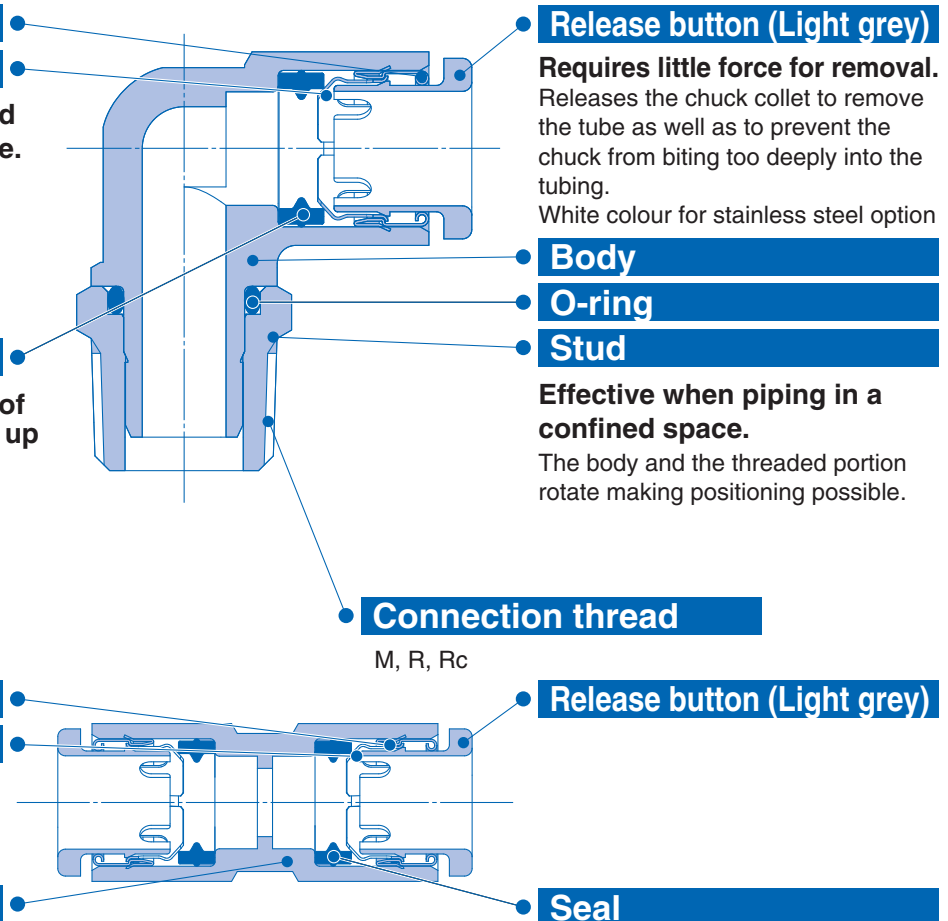

















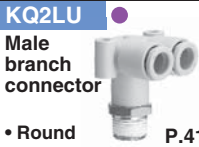



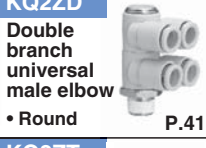

Body



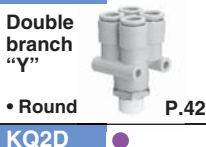



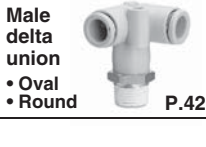











* All 100% resin body fittings without threaded parts are copper free.















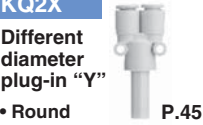



Note) For inch size, refer to the **WEB catalogue** at www.smc.eu







- KQ2
- KQ2-Uni
- KQB2
- KS/KX
- KM
- KF
- M
- H/DL L/LL
- KC
- KK
- KKH
- KK 130
- DM
- DMK
- KDM
- MQR
- KB
- KR-W2
- KRM
- KA
- KQG2
- KG
- KFG2
- MS
- KKA
- KP
- KPQ/KPG
- LQ1
- LQ3
- LQHB

Tubing  Female thread hole	
KQ2H  Male connector  • Oval • Round P.38	
KQ2S  Hexagon socket head male connector  • Oval • Round P.38	
KQ2L  Male elbow  • Oval • Round P.38	
KQ2K  45° male elbow  • Oval • Round P.38	KQ2VT Triple universal male elbow  • Round P.40
KQ2W  Extended male elbow  • Oval • Round P.39	KQ2LU  Male branch connector  • Round P.41
KQ2V  Universal male elbow  • Oval • Round P.39	KQ2Z Branch universal male elbow  • Round P.41
KQ2VS Hexagon socket head universal male elbow  • Oval • Round P.39	KQ2ZD Double branch universal male elbow  • Round P.41
KQ2T  Male branch tee  • Oval • Round P.39	KQ2ZT Triple branch universal male elbow  • Round P.41
KQ2Y  Male run tee  • Oval • Round P.40	KQ2UD  Double branch "Y"  • Round P.42
KQ2U  Branch "Y"  • Round P.40	KQ2D  Male delta union  • Oval • Round P.42
KQ2VD Double universal male elbow  • Oval • Round P.40	

Tubing  Tubing	
KQ2H Straight union  • Oval • Round P.43	KQ2T Different diameter tee  • Oval • Round P.44
KQ2E  Bulkhead union  • Oval • Round P.43	KQ2U Different diameter union "Y"  • Round P.44
KQ2L Union elbow  • Oval • Round P.43	KQ2UD Different diameter double union "Y"  • Round P.44
KQ2LE Bulkhead male elbow  • Oval • Round P.43	KQ2LU Branch union elbow  • Round P.43
KQ2T Union tee  • Oval • Round P.43	KQ2D Delta union  • Oval • Round P.43
KQ2U Union "Y"  • Round P.43	KQ2TW Cross  • Oval • Round P.43
KQ2H Different diameter straight  • Oval • Round P.43	KQ2TX Different diameter cross  • Oval • Round P.43
KQ2T Different diameter tee  • Oval • Round P.44	KQ2TY Different diameter cross  • Oval • Round P.43

Tubing  One-touch fittings	
KQ2L Plug-in elbow  • Oval • Round P.45	KQ2U Plug-in "Y"  • Round P.45
KQ2W Extended plug-in elbow  • Oval • Round P.45	KQ2X Different diameter plug-in "Y"  • Round P.45
KQ2R Plug-in reducer  • Oval • Round P.45	KQ2XD Double plug-in "Y"  • Round P.45
KQ2L Reducer elbow  • Oval • Round P.45	

Tubing  Male thread	
KQ2F  Female connector  • Oval • Round P.46	KQ2VF Universal female elbow  • Oval • Round P.46
KQ2E  Bulkhead connector  • Oval • Round P.46	KQ2ZF Branch universal female elbow  • Round P.46
KQ2LF Female elbow  • Oval • Round P.46	

Accessory	
KQ2P Plug  P.47	KQ2N Adaptor  P.47
KQ2N Nipple  P.47	KQ2C Tube cap  P.47
KQ2N Reducer nipple  P.47	KQ2C Colour cap  P.47

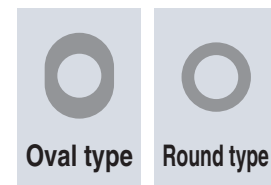

• Stainless Steel option available (KQ2-G)



Male connector

KQ2H

Use to pipe a female thread.
Most general model.



<M>



<R>

Applicable tubing O.D. [mm]	Connection thread	Model	
		Round Type	Oval Type
Ø 2	M3 x 0.5	KQ2H02-M3G	—
	M5 x 0.8	KQ2H02-M5□	—
Ø 3.2	M3 x 0.5	KQ2H23-M3G	KQ2H23-M3G1
	M5 x 0.8	KQ2H23-M5□	KQ2H23-M5□1
	R 1/8	KQ2H23-01□S	KQ2H23-01□S1
	R 1/4	KQ2H23-02□S	KQ2H23-02□S1
Ø 4	M3 x 0.5	KQ2H04-M3G	KQ2H04-M3G1
	M5 x 0.8	KQ2H04-M5□	KQ2H04-M5□1
	M6 x 1.0	KQ2H04-M6□	KQ2H04-M6□1
	R 1/8	KQ2H04-01□S	KQ2H04-01□S1
Ø 6	M3 x 0.5	KQ2H06-M3G	KQ2H06-M3G1
	M5 x 0.8	KQ2H06-M5□	KQ2H06-M5□1
	M6 x 1.0	KQ2H06-M6□	KQ2H06-M6□1
	R 1/8	KQ2H06-01□S	KQ2H06-01□S1
Ø 8	M3 x 0.5	KQ2H08-M3G	KQ2H08-M3G1
	M5 x 0.8	KQ2H08-M5□	KQ2H08-M5□1
	M6 x 1.0	KQ2H08-M6□	KQ2H08-M6□1
	R 1/8	KQ2H08-01■S	—
Ø 10	M3 x 0.5	KQ2H10-M3G	KQ2H10-M3G1
	M5 x 0.8	KQ2H10-M5□	KQ2H10-M5□1
	M6 x 1.0	KQ2H10-M6□	KQ2H10-M6□1
	R 1/8	KQ2H10-01■S	—
Ø 12	M3 x 0.5	KQ2H12-M3G	KQ2H12-M3G1
	M5 x 0.8	KQ2H12-M5□	KQ2H12-M5□1
	M6 x 1.0	KQ2H12-M6□	KQ2H12-M6□1
	R 1/8	KQ2H12-01■S	—
Ø 16	M3 x 0.5	KQ2H16-M3G	KQ2H16-M3G1
	M5 x 0.8	KQ2H16-M5□	KQ2H16-M5□1
	M6 x 1.0	KQ2H16-M6□	KQ2H16-M6□1
	R 1/8	KQ2H16-01■S	—

□/A: Brass, N: Brass + Electroless nickel plated
■/A: Brass, N: Brass + Electroless nickel plated, G: Stainless Steel
Note) Oval release button for p/n ended in -1.

Male elbow

KQ2L

Use to pipe a female thread at right angles.
Most general model.



<M5>



<R>

Applicable tubing O.D. [mm]	Connection thread	Model	
		Round Type	Oval Type
Ø 2	M3 x 0.5	KQ2L02-M3G	—
	M5 x 0.8	KQ2L02-M5□	—
Ø 3.2	M3 x 0.5	KQ2L23-M3G	KQ2L23-M3G1
	M5 x 0.8	KQ2L23-M5□	KQ2L23-M5□1
	R 1/8	KQ2L23-01□S	KQ2L23-01□S1
	R 1/4	KQ2L23-02□S	KQ2L23-02□S1
Ø 4	M3 x 0.5	KQ2L04-M3G	KQ2L04-M3G1
	M5 x 0.8	KQ2L04-M5□	KQ2L04-M5□1
	M6 x 1.0	KQ2L04-M6□	KQ2L04-M6□1
	R 1/8	KQ2L04-01□S	KQ2L04-01□S1
Ø 6	M3 x 0.5	KQ2L06-M3G	KQ2L06-M3G1
	M5 x 0.8	KQ2L06-M5□	KQ2L06-M5□1
	M6 x 1.0	KQ2L06-M6□	KQ2L06-M6□1
	R 1/8	KQ2L06-01□S	KQ2L06-01□S1
Ø 8	M3 x 0.5	KQ2L08-M3G	KQ2L08-M3G1
	M5 x 0.8	KQ2L08-M5□	KQ2L08-M5□1
	M6 x 1.0	KQ2L08-M6□	KQ2L08-M6□1
	R 1/8	KQ2L08-01■S	KQ2L08-01■SQS*3
Ø 10	M3 x 0.5	KQ2L10-M3G	KQ2L10-M3G1
	M5 x 0.8	KQ2L10-M5□	KQ2L10-M5□1
	M6 x 1.0	KQ2L10-M6□	KQ2L10-M6□1
	R 1/8	KQ2L10-01■S	—
Ø 12	M3 x 0.5	KQ2L12-M3G	KQ2L12-M3G1
	M5 x 0.8	KQ2L12-M5□	KQ2L12-M5□1
	M6 x 1.0	KQ2L12-M6□	KQ2L12-M6□1
	R 1/8	KQ2L12-01■S	—
Ø 16	M3 x 0.5	KQ2L16-M3G	KQ2L16-M3G1
	M5 x 0.8	KQ2L16-M5□	KQ2L16-M5□1
	M6 x 1.0	KQ2L16-M6□	KQ2L16-M6□1
	R 1/8	KQ2L16-01■S	—

□/A: Brass, N: Brass + Electroless nickel plated
■/A: Brass, N: Brass + Electroless nickel plated, G: Stainless Steel
Note) Oval release button for p/n ended in -1.
*3) For details refer P.48

Hexagon socket head male connector

KQ2S

Internal hexagon socket allows tightening with a hexagon wrench in confined spaces.



<M>



<R>

Applicable tubing O.D. [mm]	Connection thread	Model	
		Round Type	Oval Type
Ø 2	M3 x 0.5	KQ2S02-M3G	KQ2S02-M3G
Ø 3.2	M3 x 0.5	KQ2S23-M3G	KQ2S23-M3G1
	M5 x 0.8	KQ2S23-M5□	KQ2S23-M5□1
	M3 x 0.5	KQ2S04-M3G	KQ2S04-M3G1
Ø 4	M5 x 0.8	KQ2S04-M5□	KQ2S04-M5□1
	M6 x 1.0	KQ2S04-M6□	KQ2S04-M6□1
	R 1/8	KQ2S04-01□S	KQ2S04-01□S1
Ø 6	M5 x 0.8	KQ2S06-M5□	KQ2S06-M5□1
	M6 x 1.0	KQ2S06-M6□	KQ2S06-M6□1
	R 1/8	KQ2S06-01□S	KQ2S06-01□S1
Ø 8	M3 x 0.5	KQ2S08-M3G	KQ2S08-M3G1
	M5 x 0.8	KQ2S08-M5□	KQ2S08-M5□1
	R 1/4	KQ2S08-02■S	—
Ø 10	M3 x 0.5	KQ2S10-M3G	KQ2S10-M3G1
	M5 x 0.8	KQ2S10-M5□	KQ2S10-M5□1
	R 1/4	KQ2S10-03■S	—
Ø 12	M3 x 0.5	KQ2S12-M3G	KQ2S12-M3G1
	M5 x 0.8	KQ2S12-M5□	KQ2S12-M5□1
	R 1/2	KQ2S12-04■S	—
Ø 16	M3 x 0.5	KQ2S16-M3G	KQ2S16-M3G1
	M5 x 0.8	KQ2S16-M5□	KQ2S16-M5□1
	R 1/2	KQ2S16-04□S	—

□/A: Brass, N: Brass + Electroless nickel plated
■/A: Brass, N: Brass + Electroless nickel plated, G: Stainless Steel
Note) Oval release button for p/n ended in -1.

45° male elbow

KQ2K

Use to pipe a female thread at a 45° angle.
The model between the male connector and male elbow.



<M>



<R>

Applicable tubing O.D. [mm]	Connection thread	Model	
		Round Type	Oval Type
Ø 4	M5 x 0.8	KQ2K04-M5□	KQ2K04-M5□1
	M6 x 1.0	KQ2K04-M6□	KQ2K04-M6□1
	R 1/8	KQ2K04-01□S	KQ2K04-01□S1
	R 1/4	KQ2K04-02□S	KQ2K04-02□S1
Ø 6	M5 x 0.8	KQ2K06-M5□	KQ2K06-M5□1
	M6 x 1.0	KQ2K06-M6□	KQ2K06-M6□1
	R 1/8	KQ2K06-01□S	KQ2K06-01□S1
	R 1/4	KQ2K06-02□S	KQ2K06-02□S1
Ø 8	M5 x 0.8	KQ2K08-M5□	KQ2K08-M5□1
	M6 x 1.0	KQ2K08-M6□	KQ2K08-M6□1
	R 1/8	KQ2K08-01□S	KQ2K08-01□S1
	R 1/4	KQ2K08-02□S	KQ2K08-02□SQS*3
Ø 10	M5 x 0.8	KQ2K10-M5□	KQ2K10-M5□1
	M6 x 1.0	KQ2K10-M6□	KQ2K10-M6□1
	R 1/8	KQ2K10-01□S	—
	R 1/4	KQ2K10-02□S	—
Ø 12	M5 x 0.8	KQ2K12-M5□	KQ2K12-M5□1
	M6 x 1.0	KQ2K12-M6□	KQ2K12-M6□1
	R 1/8	KQ2K12-01□S	—
	R 1/4	KQ2K12-02□S	—
Ø 16	M5 x 0.8	KQ2K16-M5□	KQ2K16-M5□1
	M6 x 1.0	KQ2K16-M6□	KQ2K16-M6□1
	R 1/8	KQ2K16-01□S	—
	R 1/4	KQ2K16-02□S	—

□/A: Brass, N: Brass + Electroless nickel plated
Note) Oval release button for p/n ended in -1.
*3) For details refer P.48

Note) For dimensions and other details refer to specific catalogue of the series at www.smc.eu



Extended male elbow

KQ2W

Basically, it is used together with male elbow. Different point is that it is used for fittings to avoid interfering with each other by making the piping multi-level.

Applicable tubing O.D. [mm]	Connection thread	Model	
		Round Type	Oval Type
Ø 2	M3 x 0.5	KQ2W02-M3G	
	M5 x 0.8	KQ2W02-M5□	
Ø 3.2	M3 x 0.5	KQ2W23-M3G	KQ2W23-M3G1
	M5 x 0.8	KQ2W23-M5□	KQ2W23-M5□1
	R 1/8	KQ2W23-01□S	KQ2W23-01□S1
	R 1/4	KQ2W23-02□S	KQ2W23-02□S1
Ø 4	M3 x 0.5	KQ2W04-M3G	KQ2W04-M3G1
	M5 x 0.8	KQ2W04-M5□	KQ2W04-M5□1
	R 1/8	KQ2W04-01□S	KQ2W04-01□S1
	R 1/4	KQ2W04-02□S	KQ2W04-02□S1
Ø 6	M5 x 0.8	KQ2W06-M5□	KQ2W06-M5□1
	R 1/8	KQ2W06-01□S	KQ2W06-01□S1
	R 1/4	KQ2W06-02□S	KQ2W06-02□S1
	R 3/8	KQ2W06-03□S	KQ2W06-03□S1
Ø 8	R 1/8	KQ2W08-01□S	KQ2W08-01□S ^{*3}
	R 1/4	KQ2W08-02□S	—
	R 3/8	KQ2W08-03□S	—
Ø 10	R 1/4	KQ2W10-02□S	—
	R 3/8	KQ2W10-03□S	—
	R 1/2	KQ2W10-04□S	—
Ø 12	R 1/4	KQ2W12-02□S	—
	R 3/8	KQ2W12-03□S	—
	R 1/2	KQ2W12-04□S	—
Ø 16	R 1/4	KQ2W16-02□S	—
	R 3/8	KQ2W16-03□S	—
	R 1/2	KQ2W16-04□S	—

□/A: Brass, N: Brass + Electroless nickel plated

■/A: Brass, N: Brass + Electroless nickel plated, G: Stainless Steel

*3) For details refer P.48

Note) Oval release button for p/n ended in -1.

Universal male elbow

KQ2V

Hexagon head of the body allows tightening with a box wrench in confined spaces.

Applicable tubing O.D. [mm]	Connection thread	Model	
		Round Type	Oval Type
Ø 4	M5 x 0.8	KQ2V04-M5□	KQ2V04-M5■1
	R 1/8	KQ2V04-01□S	KQ2V04-01■S1
Ø 6	M5 x 0.8	KQ2V06-M5□	KQ2V06-M5■1
	R 1/8	KQ2V06-01□S	KQ2V06-01■S1
	R 1/4	KQ2V06-02□S	KQ2V06-02■S1
	R 1/8	KQ2V08-01■S	—
Ø 8	R 1/4	KQ2V08-02■S	—
	R 3/8	KQ2V08-03■S	—
	R 1/4	KQ2V10-02■S	—
Ø 10	R 3/8	KQ2V10-03■S	—
	R 3/8	KQ2V12-03■S	—
Ø 12	R 1/2	KQ2V12-04■S	—
	R 3/8	KQ2V16-03□S	—
Ø 16	R 1/2	KQ2V16-04□S	—

□/A: Brass, N: Brass + Electroless nickel plated

■/A: Brass, N: Brass + Electroless nickel plated, G: Stainless Steel

Note) Oval release button for p/n ended in -1.

Note) For dimensions and other details refer to specific catalogue of the series at www.smc.eu

Hexagon socket head universal male elbow

KQ2VS

Hexagon socket on the top allows tightening with a hexagon wrench in confined spaces.

Applicable tubing O.D. [mm]	Connection thread	Model	
		Round Type	Oval Type
Ø 4	M5 x 0.8	KQ2VS04-M5□	KQ2VS04-M5□1
	R 1/8	KQ2VS04-01□S	KQ2VS04-01□S1
Ø 6	M5 x 0.8	KQ2VS06-M5□	KQ2VS06-M5□1
	R 1/8	KQ2VS06-01□S	KQ2VS06-01□S1
	R 1/4	KQ2VS06-02□S	KQ2VS06-02□S1
Ø 8	R 1/8	KQ2VS08-01□S	—
	R 1/4	KQ2VS08-02□S	—
Ø 10	R 3/8	KQ2VS08-03□S	—
	R 1/4	KQ2VS10-02□S	—
Ø 12	R 3/8	KQ2VS10-03□S	—
	R 3/8	KQ2VS12-03□S	—
Ø 16	R 1/2	KQ2VS12-04□S	—

□/A: Brass, N: Brass + Electroless nickel plated

Note) Oval release button for p/n ended in -1.

Male branch tee

KQ2T

Use to branch a female thread at both 90° angles.

Applicable tubing O.D. [mm]	Connection thread	Model	
		Round Type	Oval Type
Ø 2	M3 x 0.5	KQ2T02-M3G	
	M5 x 0.8	KQ2T02-M5□	
Ø 3.2	M3 x 0.5	KQ2T23-M3G	KQ2T23-M3G1
	M5 x 0.8	KQ2T23-M5□	KQ2T23-M5□1
	R 1/8	KQ2T23-01□S	KQ2T23-01□S1
	R 1/4	KQ2T23-02□S	KQ2T23-02□S1
Ø 4	M3 x 0.5	KQ2T04-M3G	KQ2T04-M3G1
	M5 x 0.8	KQ2T04-M5□	KQ2T04-M5■1
	M6 x 1.0	KQ2T04-M6□	KQ2T04-M6□1
	R 1/8	KQ2T04-01□S	KQ2T04-01■S1
Ø 6	R 1/4	KQ2T04-02□S	KQ2T04-02■S1
	M5 x 0.8	KQ2T06-M5□	KQ2T06-M5■1
	M6 x 1.0	KQ2T06-M6□	KQ2T06-M6□1
Ø 8	R 1/8	KQ2T06-01□S	KQ2T06-01■S1
	R 1/4	KQ2T06-02□S	KQ2T06-02■S1
	R 3/8	KQ2T06-03□S	KQ2T06-03■S1
	R 1/8	KQ2T08-01■S	KQ2T08-01■S ^{*3}
Ø 10	R 1/4	KQ2T08-02■S	—
	R 3/8	KQ2T08-03■S	—
	R 1/8	KQ2T10-01■S	—
Ø 12	R 1/4	KQ2T10-02■S	—
	R 3/8	KQ2T10-03■S	—
	R 1/2	KQ2T10-04■S	—
Ø 16	R 1/4	KQ2T12-02■S	—
	R 3/8	KQ2T12-03■S	—
Ø 16	R 1/2	KQ2T12-04■S	—
	R 1/4	KQ2T16-02□S	—
Ø 16	R 3/8	KQ2T16-03■S	—
	R 1/2	KQ2T16-04■S	—

□/A: Brass, N: Brass + Electroless nickel plated

■/A: Brass, N: Brass + Electroless nickel plated, G: Stainless Steel

*3) For details refer P.48

Note) Oval release button for p/n ended in -1.



Male run tee

KQ2Y

Use to branch a female thread at a 90° angle.

Applicable tubing O.D. [mm]	Connection thread	Model	
		Round Type	Oval Type
Ø 2	M3 x 0.5	KQ2Y02-M3G	—
	M5 x 0.8	KQ2Y02-M5□	—
Ø 3.2	M3 x 0.5	KQ2Y23-M3G	KQ2Y23-M3G1
	M5 x 0.8	KQ2Y23-M5□	KQ2Y23-M5□1
	R 1/8	KQ2Y23-01□S	—
	R 1/4	KQ2Y23-02□S	—
Ø 4	M3 x 0.5	KQ2Y04-M3G	KQ2Y04-M3G1
	M5 x 0.8	KQ2Y04-M5□	KQ2Y04-M5■1
	M6 x 1.0	KQ2Y04-M6□	KQ2Y04-M6□1
	R 1/8	KQ2Y04-01□S	KQ2Y04-01■S1
Ø 6	R 1/4	KQ2Y04-02□S	KQ2Y04-02■S1
	M5 x 0.8	KQ2Y06-M5□	KQ2Y06-M5■1
	M6 x 1.0	KQ2Y06-M6□	KQ2Y06-M6□1
	R 1/8	KQ2Y06-01□S	KQ2Y06-01■S1
Ø 8	R 1/4	KQ2Y06-02□S	KQ2Y06-02■S1
	R 3/8	KQ2Y06-03□S	KQ2Y06-03■S1
	R 1/8	KQ2Y08-01■S	KQ2Y08-01■QS*3
	R 1/4	KQ2Y08-02■S	—
Ø 10	R 3/8	KQ2Y08-03■S	—
	R 1/8	KQ2Y10-01■S	—
	R 1/4	KQ2Y10-02■S	—
	R 3/8	KQ2Y10-03■S	—
Ø 12	R 1/2	KQ2Y10-04■S	—
	R 1/4	KQ2Y12-02■S	—
	R 3/8	KQ2Y12-03■S	—
	R 1/2	KQ2Y12-04■S	—
Ø 16	R 1/4	KQ2Y16-02□S	—
	R 3/8	KQ2Y16-03■S	—
	R 1/2	KQ2Y16-04■S	—

□/A: Brass, N: Brass + Electroless nickel plated

■/A: Brass, N: Brass + Electroless nickel plated, G: Stainless Steel

*3) For details refer P.48

Note) Oval release button for p/n ended in -1.

Double universal male elbow

KQ2VD

Use to branch a female thread at right angles.
Two individual parts rotate 360°.

Applicable tubing O.D. [mm]	Connection thread	Model	
		Round Type	Oval Type
Ø 4	R 1/8	KQ2VD04-01□S	KQ2VD04-01□S1
	R 1/4	KQ2VD04-02□S	KQ2VD04-02□S1
	R 3/8	KQ2VD04-03□S	KQ2VD04-03□S1
Ø 6	R 1/8	KQ2VD06-01□S	KQ2VD06-01□S1
	R 1/4	KQ2VD06-02□S	KQ2VD06-02□S1
Ø 8	R 3/8	KQ2VD06-03□S	KQ2VD06-03□S1
	R 1/8	KQ2VD08-01□S	—
Ø 10	R 1/4	KQ2VD08-02□S	—
	R 3/8	KQ2VD08-03□S	—
	R 1/2	KQ2VD08-04□S	—
Ø 12	R 1/4	KQ2VD10-02□S	—
	R 3/8	KQ2VD10-03□S	—
	R 1/2	KQ2VD10-04□S	—
Ø 16	R 1/4	KQ2VD12-02□S	—
	R 3/8	KQ2VD12-03□S	—
	R 1/2	KQ2VD12-04□S	—

□/A: Brass, N: Brass + Electroless nickel plated

Note) Oval release button for p/n ended in -1.

Branch “Y”

KQ2U

Use to branch a female thread.

Applicable tubing O.D. [mm]	Connection thread	Model	
		Round Type	Oval Type
Ø 3.2	M5 x 0.8	KQ2U23-M5□	—
	R 1/8	KQ2U23-01□S	—
	R 1/4	KQ2U23-02□S	—
Ø 4	M5 x 0.8	KQ2U04-M5■	—
	M6 x 1.0	KQ2U04-M6□	—
	R 1/8	KQ2U04-01■S	—
Ø 6	R 1/4	KQ2U04-02■S	—
	M5 x 0.8	KQ2U06-M5■	—
	M6 x 1.0	KQ2U06-M6□	—
	R 1/8	KQ2U06-01■S	—
Ø 8	R 1/4	KQ2U06-02■S	—
	R 3/8	KQ2U06-03■S	—
	R 1/8	KQ2U08-01■S	—
Ø 10	R 1/4	KQ2U08-02■S	—
	R 3/8	KQ2U08-03■S	—
	R 1/2	KQ2U10-04■S	—
Ø 12	R 1/4	KQ2U10-02■S	—
	R 3/8	KQ2U10-03■S	—
	R 1/2	KQ2U10-04■S	—
Ø 16	R 1/4	KQ2U12-02■S	—
	R 3/8	KQ2U12-03■S	—
	R 1/2	KQ2U12-04■S	—

□/A: Brass, N: Brass + Electroless nickel plated

■/A: Brass, N: Brass + Electroless nickel plated, G: Stainless Steel

Triple universal male elbow

Use to three-branch a female thread at right angles.
Three individual parts rotate 360°.

Applicable tubing O.D. [mm]	Connection thread	Model	
		Round Type	Oval Type
Ø 4	R 1/8	KQ2VT04-01□S	KQ2VT04-01□S1
	R 1/4	KQ2VT04-02□S	KQ2VT04-02□S1
	R 3/8	KQ2VT04-03□S	KQ2VT04-03□S1
Ø 6	R 1/8	KQ2VT06-01□S	KQ2VT06-01□S1
	R 1/4	KQ2VT06-02□S	KQ2VT06-02□S1
Ø 8	R 3/8	KQ2VT06-03□S	KQ2VT06-03□S1
	R 1/8	KQ2VT08-01□S	—
Ø 10	R 1/4	KQ2VT08-02□S	—
	R 3/8	KQ2VT08-03□S	—
	R 1/2	KQ2VT08-04□S	—
Ø 12	R 1/4	KQ2VT10-02□S	—
	R 3/8	KQ2VT10-03□S	—
	R 1/2	KQ2VT10-04□S	—
Ø 16	R 1/4	KQ2VT12-02□S	—
	R 3/8	KQ2VT12-03□S	—
	R 1/2	KQ2VT12-04□S	—

□/A: Brass, N: Brass + Electroless nickel plated

Note) Oval release button for p/n ended in -1.

Note) For dimensions and other details refer to specific catalogue of the series at www.smc.eu



Male branch connector

KQ2LU

Use to branch a female thread at right angles.

Applicable tubing O.D. [mm]	Connection thread	Model
Ø 4	M5 x 0.8	KQ2LU04-M5■
	M6 x 1.0	KQ2LU04-M6□
	R 1/8	KQ2LU04-01■S
	R 1/4	KQ2LU04-02■S
Ø 6	M5 x 0.8	KQ2LU06-M5■
	M6 x 1.0	KQ2LU06-M6□
	R 1/8	KQ2LU06-01■S
	R 1/4	KQ2LU06-02■S
Ø 8	R 3/8	KQ2LU06-03■S
	R 1/8	KQ2LU08-01■S
	R 1/4	KQ2LU08-02■S
Ø 10	R 3/8	KQ2LU08-03■S
	R 1/4	KQ2LU10-02■S
	R 3/8	KQ2LU10-03■S
Ø 12	R 1/2	KQ2LU10-04■S
	R 1/4	KQ2LU12-02■S
	R 3/8	KQ2LU12-03■S
	R 1/2	KQ2LU12-04■S



<M>



<R>

□/A: Brass, N: Brass + Electroless nickel plated

■/A: Brass, N: Brass + Electroless nickel plated, G: Stainless Steel

Branch universal male elbow

KQ2Z

Hexagon head of the body allows tightening with a box wrench. Use for branch connections.

Applicable tubing O.D. [mm]	Connection thread	Model
Ø 4	M5 x 0.8	KQ2Z04-M5□
	R 1/8	KQ2Z04-01□S
Ø 6	R 1/8	KQ2Z06-01□S
	R 1/4	KQ2Z06-02□S
	R 3/8	KQ2Z06-03□S
Ø 8	R 1/8	KQ2Z08-01□S
	R 1/4	KQ2Z08-02□S
	R 3/8	KQ2Z08-03□S
Ø 10	R 1/4	KQ2Z10-02□S
	R 3/8	KQ2Z10-03□S
Ø 12	R 3/8	KQ2Z12-03□S
	R 1/2	KQ2Z12-04□S



<M5>



<R>

□/A: Brass, N: Brass + Electroless nickel plated

Double branch universal male elbow

KQ2ZD

Use to four-branch a female thread at right angles. Two individual parts rotate 360°.

Applicable tubing O.D. [mm]	Connection thread	Model
Ø 4	R 1/8	KQ2ZD04-01□S
	R 1/4	KQ2ZD04-02□S
	R 3/8	KQ2ZD04-03□S
Ø 6	R 1/8	KQ2ZD06-01□S
	R 1/4	KQ2ZD06-02□S
	R 3/8	KQ2ZD06-03□S
Ø 8	R 1/8	KQ2ZD08-01□S
	R 1/4	KQ2ZD08-02□S
	R 3/8	KQ2ZD08-03□S
	R 1/2	KQ2ZD08-04□S
Ø 10	R 1/4	KQ2ZD10-02□S
	R 3/8	KQ2ZD10-03□S
	R 1/2	KQ2ZD10-04□S
Ø 12	R 1/4	KQ2ZD12-02□S
	R 3/8	KQ2ZD12-03□S
	R 1/2	KQ2ZD12-04□S



□/A: Brass, N: Brass + Electroless nickel plated

Triple branch universal male elbow

KQ2ZT

Use to six-branch a female thread at right angles. Three individual parts rotate 360°.

Applicable tubing O.D. [mm]	Connection thread	Model
Ø 4	R 1/8	KQ2ZT04-01□S
	R 1/4	KQ2ZT04-02□S
	R 3/8	KQ2ZT04-03□S
Ø 6	R 1/8	KQ2ZT06-01□S
	R 1/4	KQ2ZT06-02□S
	R 3/8	KQ2ZT06-03□S
Ø 8	R 1/8	KQ2ZT08-01□S
	R 1/4	KQ2ZT08-02□S
	R 3/8	KQ2ZT08-03□S
	R 1/2	KQ2ZT08-04□S
Ø 10	R 1/4	KQ2ZT10-02□S
	R 3/8	KQ2ZT10-03□S
	R 1/2	KQ2ZT10-04□S
Ø 12	R 1/4	KQ2ZT12-02□S
	R 3/8	KQ2ZT12-03□S
	R 1/2	KQ2ZT12-04□S



□/A: Brass, N: Brass + Electroless nickel plated

Note) For dimensions and other details refer to specific catalogue of the series at www.smc.eu



Double branch "Y"

KQ2UD

Use to four-branch tubing with size reduced.

	Applicable tubing O.D. [mm]	Connection thread	Model
	Ø 4	R 1/8	KQ2UD04-01■S
		R 1/4	KQ2UD04-02■S
	Ø 6	R 1/8	KQ2UD06-01■S
R 1/4		KQ2UD06-02■S	

□/A: Brass, N: Brass + Electroless nickel plated
 ■/A: Brass, N: Brass + Electroless nickel plated, G: Stainless Steel

Male delta union

KQ2D

Use to branch a female thread at two right angles.

	Ø 4	M5 x 0.8	Round Type	KQ2D04-M5□	KQ2D04-M5■1
			Oval Type	KQ2D04-M6□	KQ2D04-M6□1
		R 1/8	Round Type	KQ2D04-01□S	KQ2D04-01■S1
			Oval Type	KQ2D04-02□S	KQ2D04-02■S1
	Ø 6	M5 x 0.8	Round Type	KQ2D06-M5□	KQ2D06-M5■1
			Oval Type	KQ2D06-M6□	KQ2D06-M6□1
		R 1/8	Round Type	KQ2D06-01□S	KQ2D06-01■S1
			Oval Type	KQ2D06-02□S	KQ2D06-02■S1
	R 1/4	Round Type	KQ2D06-03□S	KQ2D06-03■S1	
		Oval Type			
	Ø 8	R 1/8	Round Type	KQ2D08-01■S	
		R 1/4	Round Type	KQ2D08-02■S	
R 3/8		Round Type	KQ2D08-03■S		
Ø 10	R 1/4	Round Type	KQ2D10-02■S		
	R 3/8	Round Type	KQ2D10-03■S		
Ø 12	R 1/2	Round Type	KQ2D10-04■S		
	R 1/4	Round Type	KQ2D12-02■S		
	R 3/8	Round Type	KQ2D12-03■S		
	R 1/2	Round Type	KQ2D12-04■S		

□/A: Brass, N: Brass + Electroless nickel plated
 ■/A: Brass, N: Brass + Electroless nickel plated, G: Stainless Steel
 (Note) Oval release button for p/n ended in -1.

Note) For dimensions and other details refer to specific catalogue of the series at www.smc.eu

KQ2

KQ2-
Uni

KQB2

KS/
KX

KM

KF

M

H/DL
L/LL

KC

KK

KKH

KK
130

DM

DMK

KDM

MQR

KB

KR
-W2

KRM

KA

KQG2

KG

KFG2

MS

KKA

KP

KPQ/
KPG

LQ1

LQ3

LQHB

Straight union

KQ2H

Use to connect tubing in the same direction.

	Applicable tubing O.D. [mm]	Model
	∅ 2	KQ2H02-00A
∅ 3.2	KQ2H23-00A	
∅ 4	KQ2H04-00A	
∅ 6	KQ2H06-00A	
∅ 8	KQ2H08-00A	
∅ 10	KQ2H10-00A	
∅ 12	KQ2H12-00A	
∅ 16	KQ2H16-00A	

Bulkhead union

KQ2E

Use to connect tubing through a panel, etc.

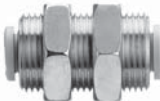
	Applicable tubing O.D. [mm]	Model	
		Round Type	Oval Type
∅ 3.2	KQ2E23-00□	KQ2E23-00□1	
∅ 4	KQ2E04-00□	KQ2E04-00■1	
∅ 6	KQ2E06-00□	KQ2E06-00■1	
∅ 8	KQ2E08-00■	—	
∅ 10	KQ2E10-00■	—	
∅ 12	KQ2E12-00■	—	
∅ 16	KQ2E16-00■	—	

□/A: Brass, N: Brass + Electroless nickel plated
 ■/A: Brass, N: Brass + Electroless nickel plated, G: Stainless Steel
 Note) Oval release button for p/n ended in -1.

Union elbow

KQ2L

Use to connect tubing at right angles.

	Applicable tubing O.D. [mm]	Model
	∅ 3.2	KQ2L23-00A
∅ 4	KQ2L04-00A	
∅ 6	KQ2L06-00A	
∅ 8	KQ2L08-00A	
∅ 10	KQ2L10-00A	
∅ 12	KQ2L12-00A	
∅ 16	KQ2L16-00A	

Note) For dimensions and other details refer to specific catalogue of the series at www.smc.eu

Bulkhead male elbow

KQ2LE

Use to connect tubing through a panel, etc. and to change the tube direction by 90°.

	Applicable tubing O.D. [mm]	Model	
		Round Type	Oval Type
∅ 4	KQ2LE04-00□	KQ2LE04-00□1	
∅ 6	KQ2LE06-00□	KQ2LE06-00□1	
∅ 8	KQ2LE08-00□	—	
∅ 10	KQ2LE10-00□	—	
∅ 12	KQ2LE12-00□	—	

□/A: Brass, N: Brass + Electroless nickel plated
 Note) Oval release button for p/n ended in -1.

Union tee

KQ2T

Use to branch tubing at both 90° angles.

	Applicable tubing O.D. [mm]	Model
	∅ 2	KQ2T02-00A
∅ 3.2	KQ2T23-00A	
∅ 4	KQ2T04-00A	
∅ 6	KQ2T06-00A	
∅ 8	KQ2T08-00A	
∅ 10	KQ2T10-00A	
∅ 12	KQ2T12-00A	
∅ 16	KQ2T16-00A	

Union “Y”

KQ2U

Use to branch tubing in the same direction.

	Applicable tubing O.D. [mm]	Model
	∅ 2	KQ2U02-00A
∅ 3.2	KQ2U23-00A	
∅ 4	KQ2U04-00A	
∅ 6	KQ2U06-00A	
∅ 8	KQ2U08-00A	
∅ 10	KQ2U10-00A	
∅ 12	KQ2U12-00A	
∅ 16	KQ2U16-00A	

Different diameter straight

KQ2H

Use to connect tubing of different sizes.

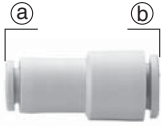
	Applicable tubing O.D. [mm]		Model
	①	②	
∅ 2	∅ 3.2	KQ2H02-23A	
∅ 2	∅ 4	KQ2H02-04A	
∅ 3.2	∅ 4	KQ2H23-04A	
∅ 3.2	∅ 6	KQ2H23-06A	
∅ 4	∅ 6	KQ2H04-06A	
∅ 6	∅ 8	KQ2H06-08A	
∅ 8	∅ 10	KQ2H08-10A	
∅ 10	∅ 12	KQ2H10-12A	
∅ 12	∅ 16	KQ2H12-16A	

Different diameter tee

KQ2T

Use to connect tubing for branching at both 90° angles with size reduced.

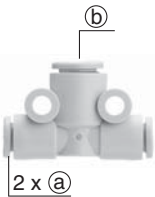
	Applicable tubing O.D. [mm]		Model
	(a)	(b)	
2 x (a)	Ø 3.2	Ø 4	KQ2T23-04A
	Ø 4	Ø 6	KQ2T04-06A
	Ø 6	Ø 8	KQ2T06-08A
	Ø 8	Ø 10	KQ2T08-10A
	Ø 10	Ø 12	KQ2T10-12A
	Ø 12	Ø 16	KQ2T12-16A

Different diameter tee

KQ2T

Use to connect tubing for branching at 90° angle with size reduced from the same piping.

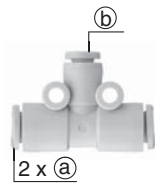
	Applicable tubing O.D. [mm]		Model
	(a)	(b)	
2 x (a)	Ø 6	Ø 4	KQ2T06-04A
	Ø 8	Ø 6	KQ2T08-06A
	Ø 10	Ø 8	KQ2T10-08A
	Ø 12	Ø 10	KQ2T12-10A

Different diameter union "Y"

KQ2U

Use to connect tubing for branching with size reduced.

	Applicable tubing O.D. [mm]		Model
	(a)	(b)	
	Ø 2	Ø 3.2	KQ2U02-23A
	Ø 2	Ø 4	KQ2U02-04A
	Ø 3.2	Ø 4	KQ2U23-04A
	Ø 4	Ø 6	KQ2U04-06A
	Ø 6	Ø 8	KQ2U06-08A
	Ø 8	Ø 10	KQ2U08-10A
	Ø 10	Ø 12	KQ2U10-12A
	Ø 12	Ø 16	KQ2U12-16A

Different diameter double union "Y"

KQ2UD

Use to four-branch tubing with size reduced.

	Applicable tubing O.D. [mm]		Model
	(a)	(b)	
4 x (a)	Ø 4	Ø 6	KQ2UD04-06A
	Ø 6	Ø 8	KQ2UD06-08A

Note) For dimensions and other details refer to specific catalogue of the series at www.smc.eu

Branch union elbow

KQ2LU

Use to branch tubing at right angles.

	Applicable tubing O.D. [mm]	Model
	Ø 4	KQ2LU04-00A
	Ø 6	KQ2LU06-00A
	Ø 8	KQ2LU08-00A
	Ø 10	KQ2LU10-00A
	Ø 12	KQ2LU12-00A

Delta union

KQ2D

Use to branch tubing at three right angles.

	Applicable tubing O.D. [mm]	Model
	Ø 4	KQ2D04-00A
	Ø 6	KQ2D06-00A
	Ø 8	KQ2D08-00A
	Ø 10	KQ2D10-00A
	Ø 12	KQ2D12-00A

Cross

KQ2TW

Use to four-branch line.

	Applicable tubing O.D. [mm]	Model
	Ø 4	KQ2TW04-00A
	Ø 6	KQ2TW06-00A
	Ø 8	KQ2TW08-00A
	Ø 10	KQ2TW10-00A
	Ø 12	KQ2TW12-00A

Different diameter cross

KQ2TX

Use to branch tubing with size reduced at both 90° angles.

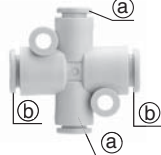
	Applicable tubing O.D. [mm]		Model	
	(a)	(b)		
	Ø 6	Ø 8		KQ2TX06-08A
	Ø 8	Ø 10		KQ2TX08-10A
	Ø 10	Ø 12	KQ2TX10-12A	

Different diameter cross

KQ2TY

Use to connect tubing for branching in three directions with size reduced.

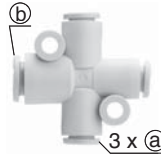
	Applicable tubing O.D. [mm]		Model	
	(a)	(b)		
	Ø 6	Ø 8		KQ2TY06-08A
	Ø 8	Ø 10		KQ2TY08-10A
	Ø 10	Ø 12	KQ2TY10-12A	



Plug-in elbow

KQ2L

Use to change the tube direction from One-touch fittings by 90°.



Applicable tubing O.D. [mm]	Applicable fitting size	Model
Ø 3.2	Ø 3.2	KQ2L23-99A
Ø 4	Ø 4	KQ2L04-99A
Ø 6	Ø 6	KQ2L06-99A
Ø 8	Ø 8	KQ2L08-99A
Ø 10	Ø 10	KQ2L10-99A
Ø 12	Ø 12	KQ2L12-99A
Ø 16	Ø 16	KQ2L16-99A

Reducer elbow

KQ2L

Use to change the tube direction from One-touch fittings by 90° and to reduce size.



Applicable tubing O.D. [mm]	Applicable fitting size	Model
Ø 3.2	Ø 4	KQ2L23-04A
	Ø 6	KQ2L23-06A
Ø 4	Ø 6	KQ2L04-06A
	Ø 8	KQ2L04-08A
Ø 6	Ø 8	KQ2L06-08A
	Ø 10	KQ2L06-10A
Ø 8	Ø 10	KQ2L08-10A
	Ø 12	KQ2L08-12A
Ø 10	Ø 12	KQ2L10-12A
	Ø 16	KQ2L10-16A

Extended plug-in elbow

KQ2W

Use to change the tube direction of One-touch fittings by 90°. Multi-level piping is also possible with the plug-in elbow.

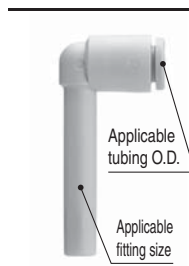

Applicable tubing O.D. [mm]	Applicable fitting size	Model
Ø 3.2	Ø 3.2	KQ2W23-99A
Ø 4	Ø 4	KQ2W04-99A
Ø 6	Ø 6	KQ2W06-99A
Ø 8	Ø 8	KQ2W08-99A
Ø 10	Ø 10	KQ2W10-99A
Ø 12	Ø 12	KQ2W12-99A

Plug-in "Y"

KQ2U

Use to branch One-touch fittings.

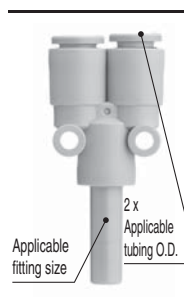

Applicable tubing O.D. [mm]	Applicable fitting size	Model
Ø 3.2	Ø 3.2	KQ2U23-99A
Ø 4	Ø 4	KQ2U04-99A
Ø 6	Ø 6	KQ2U06-99A
Ø 8	Ø 8	KQ2U08-99A
Ø 10	Ø 10	KQ2U10-99A
Ø 12	Ø 12	KQ2U12-99A
Ø 16	Ø 16	KQ2U16-99A

Plug-in reducer

KQ2R

Use to change size of One-touch fittings.



Applicable tubing O.D. [mm]	Applicable fitting size	Model
Ø 2	Ø 4	KQ2R02-04A
	Ø 3.2	KQ2R23-04A
Ø 3.2	Ø 4	KQ2R23-04A
	Ø 6	KQ2R23-06A
	Ø 8	KQ2R23-08A
Ø 4	Ø 6	KQ2R04-06A
	Ø 8	KQ2R04-08A
	Ø 10	KQ2R04-10A
Ø 6	Ø 4	KQ2R06-04A
	Ø 8	KQ2R06-08A
	Ø 10	KQ2R06-10A
	Ø 12	KQ2R06-12A
Ø 8	Ø 10	KQ2R08-10A
	Ø 12	KQ2R08-12A
Ø 10	Ø 12	KQ2R10-12A
	Ø 16	KQ2R10-16A
Ø 12	Ø 16	KQ2R12-16A

Different diameter plug-in "Y"

KQ2X

Use to branch One-touch fittings with size reduced.

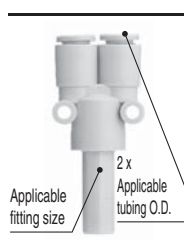

Applicable tubing O.D. [mm]	Applicable fitting size	Model
Ø 3.2	Ø 4	KQ2X23-04A
	Ø 6	KQ2X23-06A
Ø 4	Ø 6	KQ2X04-06A
	Ø 8	KQ2X04-08A
Ø 6	Ø 8	KQ2X06-08A
	Ø 10	KQ2X06-10A
Ø 8	Ø 10	KQ2X08-10A
Ø 10	Ø 12	KQ2X10-12A

Double plug-in "Y"

KQ2XD

Use to four-branch One-touch fittings with size reduced.

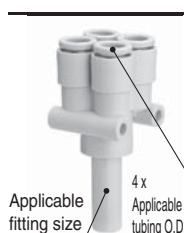

Applicable tubing O.D. [mm]	Applicable fitting size	Model
Ø 4	Ø 6	KQ2XD04-06A
Ø 6	Ø 8	KQ2XD06-08A

Note) For dimensions and other details refer to specific catalogue of the series at www.smc.eu

Female connector

KQ2F

Use to pipe a male thread of a pressure gauge, etc.

Applicable tubing O.D. [mm]	Connection thread	Model	
		Round Type	Oval Type
Ø 3.2	M3 x 0.5	KQ2F23-M3□	KQ2F23-M3□1
	M5 x 0.8	KQ2F23-M5□	KQ2F23-M5□1
Ø 4	M3 x 0.5	KQ2F04-M3□	KQ2F04-M3□1
	M5 x 0.8	KQ2F04-M5□	KQ2F04-M5□1
	Rc 1/8	KQ2F04-01□	KQ2F04-01■1
	Rc 1/4	KQ2F04-02□	KQ2F04-02■1
Ø 6	M5 x 0.8	KQ2F06-M5□	KQ2F06-M5□1
	Rc 1/8	KQ2F06-01□	KQ2F06-01■1
	Rc 1/4	KQ2F06-02□	KQ2F06-02■1
	Rc 3/8	KQ2F06-03□	KQ2F06-03■1
Ø 8	Rc 1/8	KQ2F08-01■	—
	Rc 1/4	KQ2F08-02■	—
	Rc 3/8	KQ2F08-03■	—
Ø 10	Rc 1/4	KQ2F10-02■	—
	Rc 3/8	KQ2F10-03■	—
Ø 12	Rc 1/4	KQ2F12-02■	—
	Rc 3/8	KQ2F12-03■	—
	Rc 1/2	KQ2F12-04■	—
Ø 16	Rc 3/8	KQ2F16-03□	—
	Rc 1/2	KQ2F16-04□	—



□/A: Brass, N: Brass + Electroless nickel plated

■/A: Brass, N: Brass + Electroless nickel plated, G: Stainless Steel

Note) Oval release button for p/n ended in -1

Bulkhead connector

KQ2E

Use to connect tubing through a panel, etc.

Applicable tubing O.D. [mm]	Connection thread	Model	
		Round Type	Oval Type
Ø 3.2	Rc 1/4	KQ2E23-02□	KQ2E23-02□1
	Rc 1/8	KQ2E04-01□	KQ2E04-01■1
Ø 4	Rc 1/4	KQ2E04-02□	KQ2E04-02■1
	Rc 1/8	KQ2E06-01□	KQ2E06-01■1
Ø 6	Rc 1/4	KQ2E06-02□	KQ2E06-02■1
	Rc 3/8	KQ2E06-03□	KQ2E06-03■1
Ø 8	Rc 1/8	KQ2E08-01■	—
	Rc 1/4	KQ2E08-02■	—
	Rc 3/8	KQ2E08-03■	—
Ø 10	Rc 1/4	KQ2E10-02■	—
	Rc 3/8	KQ2E10-03■	—
Ø 12	Rc 3/8	KQ2E12-03■	—
	Rc 1/2	KQ2E12-04■	—
	Rc 3/8	KQ2E16-03■	—
Ø 16	Rc 1/2	KQ2E16-04■	—



□/A: Brass, N: Brass + Electroless nickel plated

■/A: Brass, N: Brass + Electroless nickel plated, G: Stainless Steel

Note) Oval release button for p/n ended in -1.

Note) For dimensions and other details refer to specific catalogue of the series at www.smc.eu

Female elbow

KQ2LF

Use to pipe a male thread at right angles.

Applicable tubing O.D. [mm]	Connection thread	Model	
		Round Type	Oval Type
Ø 4	M5 x 0.8	KQ2LF04-M5□	KQ2LF04-M5□1
	M6 x 1.0	KQ2LF04-M6□	KQ2LF04-M6□1
	Rc 1/8	KQ2LF04-01□	KQ2LF04-01□1
	Rc 1/4	KQ2LF04-02□	KQ2LF04-02□1
Ø 6	M5 x 0.8	KQ2LF06-M5□	KQ2LF06-M5□1
	M6 x 1.0	KQ2LF06-M6□	KQ2LF06-M6□1
	Rc 1/8	KQ2LF06-01□	KQ2LF06-01□1
	Rc 1/4	KQ2LF06-02□	KQ2LF06-02□1
Ø 8	Rc 3/8	KQ2LF06-03□	KQ2LF06-03□1
	Rc 1/8	KQ2LF08-01□	KQ2LF08-01□□*3
	Rc 1/4	KQ2LF08-02□	—
Ø 10	Rc 3/8	KQ2LF08-03□	—
	Rc 1/4	KQ2LF10-02□	—
	Rc 3/8	KQ2LF10-03□	—
Ø 12	Rc 1/2	KQ2LF10-04□	—
	Rc 1/4	KQ2LF12-02□	—
	Rc 3/8	KQ2LF12-03□	—
Ø 12	Rc 1/2	KQ2LF12-04□	—



□/A: Brass, N: Brass + Electroless nickel plated

*3) For details refer P.48

Note) Oval release button for p/n ended in -1.

Universal female elbow

KQ2VF

Use to branch a male or female thread at a 90° angle.

Multiple connections possible.

Applicable tubing O.D. [mm]	Connection thread	Model	
		Round Type	Oval Type
Ø 4	M5 x 0.8	KQ2VF04-M5□	KQ2VF04-M5□1
	R, Rc 1/8	KQ2VF04-01□S	KQ2VF04-01□S1
Ø 6	M5 x 0.8	KQ2VF06-M5□	KQ2VF06-M5□1
	R, Rc 1/8	KQ2VF06-01□S	KQ2VF06-01□S1
Ø 8	R, Rc 1/4	KQ2VF06-02□S	KQ2VF06-02□S1
	R, Rc 1/8	KQ2VF08-01□S	—
Ø 10	R, Rc 1/4	KQ2VF08-02□S	—
	R, Rc 3/8	KQ2VF08-03□S	—
Ø 12	R, Rc 1/4	KQ2VF10-02□S	—
	R, Rc 3/8	KQ2VF10-03□S	—
Ø 12	R, Rc 3/8	KQ2VF12-03□S	—
	R, Rc 1/2	KQ2VF12-04□S	—



□/A: Brass, N: Brass + Electroless nickel plated

Note) Oval release button for p/n ended in -1.

Branch universal female elbow

KQ2ZF

Use to two-branch a male or female thread at a 90° angle.

Multiple connections possible.

Applicable tubing O.D. [mm]	Connection thread	Model
Ø 4	M5 x 0.8	KQ2ZF04-M5□
	R, Rc 1/8	KQ2ZF04-01□S
Ø 6	R, Rc 1/8	KQ2ZF06-01□S
	R, Rc 1/4	KQ2ZF06-02□S
Ø 8	R, Rc 1/8	KQ2ZF08-01□S
	R, Rc 1/4	KQ2ZF08-02□S
Ø 10	R, Rc 1/4	KQ2ZF10-02□S
	R, Rc 3/8	KQ2ZF10-03□S
Ø 12	R, Rc 3/8	KQ2ZF12-03□S
	R, Rc 1/2	KQ2ZF12-04□S



□/A: Brass, N: Brass + Electroless nickel plated

Plug

KQ2P

Use to plug unused One-touch fittings.

	Applicable fitting size		Model
	Ø	Model	
	Ø 2	KJP-02	
	Ø 3.2	KQ2P-23	
	Ø 4	KQ2P-04	
	Ø 6	KQ2P-06	
	Ø 8	KQ2P-08	
	Ø 10	KQ2P-10	
	Ø 12	KQ2P-12	
	Ø 16	KQ2P-16	

Tube cap

KQ2C

Use to connect One-touch fittings and R female thread.

	Applicable tubing O.D. [mm]		Model
	Ø	Model	
	Ø 4	KQ2C04-00A	
	Ø 4	KQ2C04-00A1	
	Ø 6	KQ2C06-00A	
	Ø 6	KQ2C06-00A1	
	Ø 8	KQ2C08-00A	
	Ø 10	KQ2C10-00A	
	Ø 12	KQ2C12-00A	
	Ø 16	KQ2C16-00A	

Note) Oval release button for p/n ended in -1.

Nipple

KQ2N

Use to connect One-touch fittings.

	Applicable fitting size		Model
	Ø	Model	
	Ø 4	KQ2N04-99	
	Ø 6	KQ2N06-99	
	Ø 8	KQ2N08-99	
	Ø 10	KQ2N10-99	
	Ø 12	KQ2N12-99	
	Ø 16	KQ2N16-99	

Colour cap

KQ2C

Mount onto the release button and use different colours for piping according to applications.

	Applicable tubing O.D. [mm]		Model	Note
	Ø	Model		
	Ø 2	KQ2C-02□A	Applicable for products with enlarged outside diameter of release button	
	Ø 3.2	KQ2C-23□A		
	Ø 4	KQ2C-04□A		
	Ø 6	KQ2C-06□A		
	Ø 8	KQ2C-08□B		
	Ø 10	KQ2C-10□B		
	Ø 12	KQ2C-12□B		
	Ø 16	KQ2C-16□B		

□: B (Black), R (Red), YR (Orange), BR (Brown), Y (Yellow), G (Green), CB (Sky blue), GR (Grey), W (White), BU (Blue)

Reducer nipple

KQ2N

Use to connect One-touch fittings of different sizes.

	Applicable fitting size		Model
	①	②	
	Ø 4	Ø 6	
Ø 6	Ø 8	KQ2N06-08	
Ø 8	Ø 10	KQ2N08-10	
Ø 10	Ø 12	KQ2N10-12	
Ø 12	Ø 16	KQ2N12-16	

Colour cap oval type

KQ2C

Mount onto the release button and use different colours for piping according to applications.

	Applicable tubing O.D. [mm]		Model
	Ø	Model	
	Ø 3.2	KQ2C-23□B	
	Ø 4	KQ2C-04□B	
	Ø 6	KQ2C-06□B	

□: B (Black), R (Red), YR (Orange), BR (Brown), Y (Yellow), G (Green), CB (Sky blue), GR (Grey), W (White), BU (Blue)

Adaptor

KQ2N

Use to connect One-touch fittings and R female thread.

	Applicable fitting size	Connection thread	Model
<M5>	Ø 4	M5 x 0.8	KQ2N04-M5□
		R 1/8	KQ2N04-01□S
<R>	Ø 6	M5 x 0.8	KQ2N06-M5□
		R 1/8	KQ2N06-01□S
	R 1/4	KQ2N06-02□S	
	Ø 8	R 1/4	KQ2N08-02□S
R 3/8		KQ2N08-03□S	
Ø 10	R 3/8	KQ2N10-03□S	

□/A: Brass, N: Brass + Electroless nickel plated



In order to improve the operability, the outside diameter of the release button has been enlarged for the New KQ2 series.

Along with this change, the usable colour caps differ before and after the change. Refer to page 333 for details.

Note) For dimensions and other details refer to specific catalogue of the series at www.smc.eu



Made to Order

1 Made to Order

Symbol	Specifications
X12	Lubricant: White vaseline, Release button colour: White
X35 *1	Body colour: Black, Release button colour: Light grey
X41	With fixed orifice*2
KQ2□08-01□Q□	Effective area is interchangeable with the current product (KQ series). Applicable model: Male elbow *3, 45° male elbow, Female elbow, Extended male elbow *3, Male branch tee *3, Male run tee *3 Applicable tubing O.D./Port size: Ø 8/R 1/8 Thread material/Surface treatment: Brass, Brass + Electroless nickel plating, Stainless Steel Example) KQ2L08-01AQS KQ2L09-01GQS

- *1 The following models are not available as made-to-order: Hexagon socket head male connector/KQ2S, Bulkhead union/KQ2E, Bulkhead connector/KQ2E, Nipple/KQ2N, Reducer nipple/KQ2N, Male connector/KQ2H, Female connector/KQ2F, Colour cap/KQ2C, Plug/KQ2P
- *2 Please contact SMC for availability.
- *3 Stainless Steel option available.

The following made-to-order products will be provided based on previous models (KQ2 series). Please contact SMC separately.

Symbol	Specifications
X17	Grease-free Rubber material: NBR (With fluorine coating) Release button colour: Light blue
X29	Grease-free Rubber material: NBR (With fluorine coating) Release button colour: Light blue Copper-free (With electroless nickel plating)
X34	Rubber material: FKM
X39	Grease-free Rubber material: NBR (With fluorine coating) Release button colour: Light blue Clean (Copper-free, air blow, double packaging, resin body: white)
X94	Grease-free Rubber material: FKM (With fluorine coating) Release button colour: Light blue

2 Clean Series

Please consult with SMC separately for applicable models.

Symbol	Specifications
10-	Brass parts: With electroless nickel plated Lubricant: Fluorine grease Air blow in a clean room Double package Resin body/Release button colour: White

Note) Oval type: M, R, Rc

- Example) **10-KQ2H06-02NS** (With thread) **10-KQ2H06-02NS1** (With thread)
10-KQ2H06-00A (Without thread) **10-KQ2H06-00A1** (Without thread)
10-KQ2H06-02GS (Stainless Steel) **10-KQ2H06-02GS1** (Stainless steel)

KQ2

KQ2-Uni

KQB2

KS/KX

KM

KF

M

H/DL
L/LL

KC

KK

KKH

KK
130

DM

DMK

KDM

MQR

KB

KR
-W2

KRM

KA

KQG2

KG

KFG2

MS

KKA

KP

KPQ/
KPG

LQ1

LQ3

LQHB

Spare Parts

Description	Part no.	Applicable thread
Gasket	M-3G2	M3
	M-5G2	M5
	M-6G	M6

Brass for round type

Description	Part no.	Applicable model
Pipe nut	KQ02-P01AJ	KQ2E02-00AJ
	KQ23-P01AJ	KQ2E23-00AJ
	KQ04-P01AJ	KQ2E04-00AJ
	KQ06-P01AJ	KQ2E06-00AJ
	KQ04-P01A	KQ2E23-00A, KQ2E04-00A, KQ2E23-02A KQ2E04-01A, KQ2E04-02A, KQ2LE04-00A
	KQ06-P01A	KQ2E06-00A, KQ2E06-01A, KQ2E06-02A KQ2E06-03A, KQ2LE06-00A
	KQ08-P01A	KQ2E08-00A, KQ2E08-01A, KQ2E08-02A KQ2E08-03A, KQ2LE08-00A
	KQ10-P01A	KQ2E10-00A, KQ2E10-02A, KQ2E10-03A KQ2LE10-00A
	KQ12-P01A	KQ2E12-00A, KQ2E12-03A, KQ2E12-04A KQ2LE12-00A
	KQ16-P01A	KQ2E16-00A KQ2E16-03A, KQ2E16-04A

Brass for oval type

Description	Part no.	Applicable model
Pipe nut	KQ04-P01A	KQ2E23-00A1, KQ2E04-00A1, KQ2E23-02A1
		KQ2E04-01A1, KQ2E04-02A1, KQ2LE04-00A1
	KQ06-P01A	KQ2E06-00A1, KQ2E06-01A1, KQ2E06-02A1
		KQ2E06-03A1, KQ2LE06-00A1

Brass + Electroless nickel plated for round type

Description	Part no.	Applicable model
Pipe nut	KQ02-P01NJ	KQ2E02-00NJ
	KQ23-P01NJ	KQ2E23-00NJ
	KQ04-P01NJ	KQ2E04-00NJ
	KQ06-P01NJ	KQ2E06-00NJ
	KQ04-P01N	KQ2E23-00N, KQ2E04-00N, KQ2E23-02N KQ2E04-01N, KQ2E04-02N, KQ2LE04-00N
	KQ06-P01N	KQ2E06-00N, KQ2E06-01N, KQ2E06-02N KQ2E06-03N, KQ2LE06-00N
	KQ08-P01N	KQ2E08-00N, KQ2E08-01N, KQ2E08-02N KQ2E08-03N, KQ2LE08-00N
	KQ10-P01N	KQ2E10-00N, KQ2E10-02N, KQ2E10-03N KQ2LE10-00N
	KQ12-P01N	KQ2E12-00N, KQ2E12-03N, KQ2E12-04N KQ2LE12-00N
	KQ16-P01N	KQ2E16-00N KQ2E16-03N, KQ2E16-04N

Brass + Electroless nickel plating for oval type

Description	Part no.	Applicable model
Pipe nut	KQ04-P01N	KQ2E23-00N1, KQ2E04-00N1, KQ2E23-02N1
		KQ2E04-01N1, KQ2E04-02N1, KQ2LE04-00N1
	KQ06-P01N	KQ2E06-00N1, KQ2E06-01N1, KQ2E06-02N1
		KQ2E06-03N1, KQ2LE06-00N1

Stainless Steel

Description	Part number	Applicable model
Pipe nut	KQ04-P01G	KQ2E04-00G1, KQ2E04-01G1, KQ2E04-02G1
	KQ06-P01G	KQ2E06-00G1, KQ2E06-01G1, KQ2E06-02G1, KQ2E06-03G1
	KQ08-P01G	KQ2E08-00G, KQ2E08-01G, KQ2E08-02G, KQ2E08-03G
	KQ10-P01G	KQ2E10-00G, KQ2E10-02G, KQ2E10-03G
	KQ12-P01G	KQ2E12-00G, KQ2E12-03G, KQ2E12-04G
	KQ16-P01G	KQ2E16-00G, KQ2E16-03G, KQ2E16-04G

Colour cap

Applicable tubing O.D. [mm]	Model	Note
Ø 8	KQ2C-08□A	Applicable for products before enlargement of outside diameter of release button
Ø 10	KQ2C-10□A	
Ø 12	KQ2C-12□A	
Ø 16	KQ2C-16□A	

□: B (Black), R (Red), YR (Orange), BR (Brown), Y (Yellow), G (Green),
CB (Sky blue), GR (Grey), W (White), BU (Blue)

Face Seal One-touch Fittings

RoHS

Fittings

KQ2 Series

■ Applicable tubing O.D. : Metric Size

■ Connection thread : R, Rc

One-touch IN/OUT connection.

Possible to use in vacuum to -100 kPa

New thread for piping that drastically reduced the screw-in time thanks to the face seal method.



New!

Oval type release button added!



Applicable Tubing

Tubing material	FEP, PFA, Nylon, Soft nylon, Polyurethane
Tubing O.D.	Ø 3.2, Ø 4, Ø 6, Ø 8, Ø 10, Ø 12, Ø 16

Note) Oval release button for O.D.: Ø 3,2, Ø 4, Ø 6

Specifications

Fluid		Air/Water ^{Note 1)}
Operating pressure range ^{Note 2)}		-100 kPa to 1 MPa
Proof pressure (at 23 °C)		3 MPa
Ambient and fluid temperature		-5 to 60 °C, Water: 0 to 40 °C (No freezing)
Thread	Mounting section	JIS B0203 (Taper thread for piping) JIS B0205 (Metric coarse thread)
	Nut section	JIS B0205 (Metric fine thread)
Seal on the threads		Seal ring

Note 1) The surge pressure must be under the maximum operating pressure.

Note 2) Do not use the fittings with a leak tester or for vacuum retention because they are not guaranteed for zero leakage.

Guide

Chuck

Suitable for use with nylon and urethane. Large retaining force.

The chuck provides secure retention and the collet increases the holding force on the tube.

Seal

Can be used for a wide range of pressures from a low vacuum up to a pressure of 1 MPa.

The use of a special profile ensures sealing and reduces resistance when the tube is inserted.

Face seal method

Seal ring

Piping installability is improved by changing to the face seal structure.



Release button

Requires little force for removal.

Releases the chuck collet to remove the tube as well as to prevent the chuck from biting too deeply into the tubing.

White colour for stainless steel option

Body

O-ring

Stud

Effective when piping in a confined space.

























Body part rotates allowing for positioning.

Connection thread

R, Rc

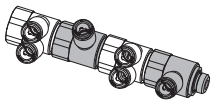
For inch size, refer to the WEB catalogue at www.smc.eu

- KQ2
- KQ2-Uni
- KQB2
- KS/KX
- KM
- KF
- M
- H/DL L/LL
- KC
- KK
- KKH
- KK 130
- DM
- DMK
- KDM
- MQR
- KB
- KR-W2
- KRM
- KA
- KQG2
- KG
- KFG2
- MS
- KKA
- KP
- KPQ/KPG
- LQ1
- LQ3
- LQHB

Tubing  Female thread hole		
KQ2H ● Male connector  • Oval • Round P.52	KQ2VS Hexagon socket head universal male elbow  • Oval • Round P.53	KQ2LU ● Male branch connector  • Round P.55
KQ2S ● Hexagon socket head male connector  • Oval • Round P.52	KQ2T ● Male branch tee  • Oval • Round P.53 Stainless Steel option	KQ2Z Branch universal male elbow  • Round P.55
KQ2L ● Male elbow  • Oval • Round P.52	KQ2Y ● Male run tee  • Oval • Round P.54 Stainless Steel option	KQ2ZD Double branch universal male elbow  • Round P.55
KQ2K 45° male elbow  • Oval • Round P.52	KQ2U ● Branch "Y"  • Round P.54 Stainless Steel option	KQ2ZT Triple branch universal male elbow  • Round P.55
KQ2W ● Extended male elbow  • Oval • Round P.53	KQ2VD Double universal male elbow  • Oval • Round P.54	KQ2UD ● Double branch "Y"  • Round P.56
KQ2V ● Universal male elbow  • Oval • Round P.53	KQ2VT Triple universal male elbow  • Oval • Round P.54	KQ2D ● Male delta union  • Oval • Round P.56
Tubing  Male thread		
Use to branch a male or female thread at a 90° angle. Multiple connections possible. 		KQ2VF Universal female elbow  • Oval • Round P.57
		KQ2ZF Branch universal female elbow  • Round P.57
Accessories		
		KQ2N ● Adaptor  P.57

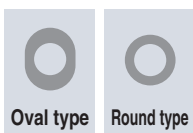

● Stainless Steel option available (KQ2-G)



Male connector

KQ2H

Use to pipe a female thread.
Most general model.

Applicable tubing O.D. [mm]	Connection thread	Model	
		Round Type	Oval Type
Ø 3.2	R 1/8	KQ2H23-01□P	KQ2H23-01□P1
	R 1/4	KQ2H23-02□P	KQ2H23-02□P1
Ø 4	R 1/8	KQ2H04-01□P	KQ2H04-01□P1
	R 1/4	KQ2H04-02□P	KQ2H04-02□P1
Ø 6	R 1/8	KQ2H06-01□P	KQ2H06-01□P1
	R 1/4	KQ2H06-02□P	KQ2H06-02□P1
	R 3/8	KQ2H06-03□P	KQ2H06-03□P1
Ø 8	R 1/8	KQ2H08-01□P	—
	R 1/4	KQ2H08-02□P	—
	R 3/8	KQ2H08-03□P	—
Ø 10	R 1/8	KQ2H10-01□P	—
	R 1/4	KQ2H10-02□P	—
	R 3/8	KQ2H10-03□P	—
	R 1/2	KQ2H10-04□P	—
Ø 12	R 1/4	KQ2H12-02□P	—
	R 3/8	KQ2H12-03□P	—
	R 1/2	KQ2H12-04□P	—
Ø 16	R 1/4	KQ2H16-02□P	—
	R 3/8	KQ2H16-03□P	—
	R 1/2	KQ2H16-04□P	—



□/A: Brass, N: Brass + Electroless nickel plated
Note) Oval release button for p/n ended in -1.

Male elbow

KQ2L

Use to pipe a female thread at right angles.
Most general model.

Applicable tubing O.D. [mm]	Connection thread	Model	
		Round Type	Oval Type
Ø 3.2	R 1/8	KQ2L23-01□P	KQ2L23-01□P1
	R 1/4	KQ2L23-02□P	KQ2L23-02□P1
Ø 4	R 1/8	KQ2L04-01□P	KQ2L04-01□P1
	R 1/4	KQ2L04-02□P	KQ2L04-02□P1
Ø 6	R 1/8	KQ2L06-01□P	KQ2L06-01□P1
	R 1/4	KQ2L06-02□P	KQ2L06-02□P1
	R 3/8	KQ2L06-03□P	KQ2L06-03□P1
Ø 8	R 1/8	KQ2L08-01□P	—
	R 1/4	KQ2L08-02□P	—
	R 3/8	KQ2L08-03□P	—
Ø 10	R 1/8	KQ2L10-01□P	—
	R 1/4	KQ2L10-02□P	—
	R 3/8	KQ2L10-03□P	—
	R 1/2	KQ2L10-04□P	—
Ø 12	R 1/4	KQ2L12-02□P	—
	R 3/8	KQ2L12-03□P	—
	R 1/2	KQ2L12-04□P	—
Ø 16	R 1/4	KQ2L16-02□P	—
	R 3/8	KQ2L16-03□P	—
	R 1/2	KQ2L16-04□P	—



□/A: Brass, N: Brass + Electroless nickel plated
Note) Oval release button for p/n ended in -1.

Hexagon socket head male connector

KQ2S

Internal hexagon socket allows tightening with a hexagon wrench in confined spaces.

Applicable tubing O.D. [mm]	Connection thread	Model	
		Round Type	Oval Type
Ø 4	R 1/8	KQ2S04-01□P	KQ2S04-01□P1
Ø 6	R 1/8	KQ2S06-01□P	KQ2S06-01□P1
	R 1/4	KQ2S06-02□P	KQ2S06-02□P1
Ø 8	R 1/8	KQ2S08-01□P	—
	R 1/4	KQ2S08-02□P	—
	R 3/8	KQ2S08-03□P	—
Ø 10	R 1/8	KQ2S10-01□P	—
	R 1/4	KQ2S10-02□P	—
	R 3/8	KQ2S10-03□P	—
	R 1/2	KQ2S10-04□P	—
Ø 12	R 1/4	KQ2S12-02□P	—
	R 3/8	KQ2S12-03□P	—
	R 1/2	KQ2S12-04□P	—
Ø 16	R 1/4	KQ2S16-02□P	—
	R 3/8	KQ2S16-03□P	—
	R 1/2	KQ2S16-04□P	—



□/A: Brass, N: Brass + Electroless nickel plated
Note) Oval release button for p/n ended in -1.

45° male elbow

KQ2K

Use to pipe a female thread at a 45° angle.
The model between the male connector and male elbow.

Applicable tubing O.D. [mm]	Connection thread	Model	
		Round Type	Oval Type
Ø 4	R 1/8	KQ2K04-01□P	KQ2K04-01□P1
	R 1/4	KQ2K04-02□P	KQ2K04-02□P1
Ø 6	R 1/8	KQ2K06-01□P	KQ2K06-01□P1
	R 1/4	KQ2K06-02□P	KQ2K06-02□P1
	R 3/8	KQ2K06-03□P	KQ2K06-03□P1
Ø 8	R 1/8	KQ2K08-01□P	—
	R 1/4	KQ2K08-02□P	—
	R 3/8	KQ2K08-03□P	—
Ø 10	R 1/8	KQ2K10-01□P	—
	R 1/4	KQ2K10-02□P	—
	R 3/8	KQ2K10-03□P	—
	R 1/2	KQ2K10-04□P	—
Ø 12	R 1/4	KQ2K12-02□P	—
	R 3/8	KQ2K12-03□P	—
	R 1/2	KQ2K12-04□P	—
Ø 16	R 1/4	KQ2K16-02□P	—
	R 3/8	KQ2K16-03□P	—
	R 1/2	KQ2K16-04□P	—



□/A: Brass, N: Brass + Electroless nickel plated
Note) Oval release button for p/n ended in -1.

Note) For dimensions and other details refer to specific catalogue of the series at www.smc.eu



Extended male elbow

KQ2W

Basically, it is used together with male elbow. Different point is that it is used for fittings to avoid interfering with each other by making the piping multi-level.

Applicable tubing O.D. [mm]	Connection thread	Model	
		Round Type	Oval Type
Ø 3.2	R 1/8	KQ2W23-01□P	KQ2W23-01□P1
	R 1/4	KQ2W23-02□P	KQ2W23-02□P1
Ø 4	R 1/8	KQ2W04-01□P	KQ2W04-01□P1
	R 1/4	KQ2W04-02□P	KQ2W04-02□P1
Ø 6	R 1/8	KQ2W06-01□P	KQ2W06-01□P1
	R 1/4	KQ2W06-02□P	KQ2W06-02□P1
Ø 8	R 1/8	KQ2W08-01□P	—
	R 1/4	KQ2W08-02□P	—
Ø 10	R 3/8	KQ2W08-03□P	—
	R 1/4	KQ2W10-02□P	—
	R 3/8	KQ2W10-03□P	—
Ø 12	R 1/2	KQ2W10-04□P	—
	R 1/4	KQ2W12-02□P	—
Ø 12	R 3/8	KQ2W12-03□P	—
	R 1/2	KQ2W12-04□P	—
Ø 16	R 1/4	KQ2W16-02□P	—
	R 3/8	KQ2W16-03□P	—
	R 1/2	KQ2W16-04□P	—



□/A: Brass, N: Brass + Electroless nickel plated
Note) Oval release button for p/n ended in -1.

Universal male elbow

KQ2V

Hexagon head of the body allows tightening with a box wrench in confined spaces.

Applicable tubing O.D. [mm]	Connection thread	Model	
		Round Type	Oval Type
Ø 4	R 1/8	KQ2V04-01□P	KQ2V04-01□P1
	R 1/4	KQ2V04-02□P	KQ2V04-02□P1
Ø 6	R 1/8	KQ2V06-01□P	KQ2V06-01□P1
	R 1/4	KQ2V06-02□P	KQ2V06-02□P1
Ø 8	R 1/8	KQ2V08-01□P	—
	R 1/4	KQ2V08-02□P	—
Ø 10	R 3/8	KQ2V08-03□P	—
	R 1/4	KQ2V10-02□P	—
Ø 10	R 3/8	KQ2V10-03□P	—
	R 1/2	KQ2V10-04□P	—
Ø 12	R 3/8	KQ2V12-03□P	—
	R 1/2	KQ2V12-04□P	—
Ø 16	R 3/8	KQ2V16-03□P	—
	R 1/2	KQ2V16-04□P	—



□/A: Brass, N: Brass + Electroless nickel plated
Note) Oval release button for p/n ended in -1.

Hexagon socket head universal male elbow

KQ2VS

Hexagon socket on the top allows tightening with a hexagon wrench in confined spaces.

Applicable tubing O.D. [mm]	Connection thread	Model	
		Round Type	Oval Type
Ø 4	R 1/8	KQ2VS04-01□P	KQ2VS04-01□P1
Ø 6	R 1/8	KQ2VS06-01□P	KQ2VS06-01□P1
	R 1/4	KQ2VS06-02□P	KQ2VS06-02□P1
Ø 8	R 1/8	KQ2VS08-01□P	—
	R 1/4	KQ2VS08-02□P	—
Ø 10	R 3/8	KQ2VS08-03□P	—
	R 1/4	KQ2VS10-02□P	—
Ø 12	R 3/8	KQ2VS10-03□P	—
	R 1/2	KQ2VS12-03□P	—
	R 1/2	KQ2VS12-04□P	—



□/A: Brass, N: Brass + Electroless nickel plated
Note) Oval release button for p/n ended in -1.

Male branch tee

KQ2T

Use to branch a female thread at both 90° angles.

Applicable tubing O.D. [mm]	Connection thread	Model	
		Round Type	Oval Type
Ø 3.2	R 1/8	KQ2T23-01□P	KQ2T23-01□P1
	R 1/4	KQ2T23-02□P	KQ2T23-02□P1
Ø 4	R 1/8	KQ2T04-01□P	KQ2T04-01□P1
	R 1/4	KQ2T04-02□P	KQ2T04-02□P1
Ø 6	R 1/8	KQ2T06-01□P	KQ2T06-01□P1
	R 1/4	KQ2T06-02□P	KQ2T06-02□P1
Ø 8	R 3/8	KQ2T06-03□P	KQ2T06-03□P1
	R 1/8	KQ2T08-01□P	—
Ø 8	R 1/4	KQ2T08-02□P	—
	R 3/8	KQ2T08-03□P	—
Ø 10	R 1/8	KQ2T10-01□P	—
	R 1/4	KQ2T10-02□P	—
Ø 10	R 3/8	KQ2T10-03□P	—
	R 1/2	KQ2T10-04□P	—
Ø 12	R 1/4	KQ2T12-02□P	—
	R 3/8	KQ2T12-03□P	—
Ø 12	R 1/2	KQ2T12-04□P	—
	R 1/4	KQ2T16-02□P	—
Ø 16	R 3/8	KQ2T16-03□P	—
	R 1/2	KQ2T16-04□P	—



□/A: Brass, N: Brass + Electroless nickel plated
Note) Oval release button for p/n ended in -1.

Note) For dimensions and other details refer to specific catalogue of the series at www.smc.eu



Male run tee

KQ2Y

Use to branch a female thread at a 90° angle.

Applicable tubing O.D. [mm]	Connection thread	Model	
		Round Type	Oval Type
Ø 3.2	R 1/8	KQ2Y23-01□P	KQ2Y23-01□P1
	R 1/4	KQ2Y23-02□P	KQ2Y23-02□P1
Ø 4	R 1/8	KQ2Y04-01□P	KQ2Y04-01□P1
	R 1/4	KQ2Y04-02□P	KQ2Y04-02□P1
Ø 6	R 1/8	KQ2Y06-01□P	KQ2Y06-01□P1
	R 1/4	KQ2Y06-02□P	KQ2Y06-02□P1
	R 3/8	KQ2Y06-03□P	KQ2Y06-03□P1
Ø 8	R 1/8	KQ2Y08-01□P	—
	R 1/4	KQ2Y08-02□P	—
	R 3/8	KQ2Y08-03□P	—
Ø 10	R 1/8	KQ2Y10-01□P	—
	R 1/4	KQ2Y10-02□P	—
	R 3/8	KQ2Y10-03□P	—
	R 1/2	KQ2Y10-04□P	—
Ø 12	R 1/4	KQ2Y12-02□P	—
	R 3/8	KQ2Y12-03□P	—
	R 1/2	KQ2Y12-04□P	—
Ø 16	R 1/4	KQ2Y16-02□P	—
	R 3/8	KQ2Y16-03□P	—
	R 1/2	KQ2Y16-04□P	—



□/A: Brass, N: Brass + Electroless nickel plated
Note) Oval release button for p/n ended in -1.

Branch “Y”

KQ2U

Use to branch a female thread.

Applicable tubing O.D. [mm]	Connection thread	Model	
		Round Type	Oval Type
Ø 3.2	R 1/8	KQ2U23-01□P	—
	R 1/4	KQ2U23-02□P	—
Ø 4	R 1/8	KQ2U04-01□P	—
	R 1/4	KQ2U04-02□P	—
Ø 6	R 1/8	KQ2U06-01□P	—
	R 1/4	KQ2U06-02□P	—
	R 3/8	KQ2U06-03□P	—
Ø 8	R 1/8	KQ2U08-01□P	—
	R 1/4	KQ2U08-02□P	—
	R 3/8	KQ2U08-03□P	—
Ø 10	R 1/4	KQ2U10-02□P	—
	R 3/8	KQ2U10-03□P	—
	R 1/2	KQ2U10-04□P	—
Ø 12	R 1/4	KQ2U12-02□P	—
	R 3/8	KQ2U12-03□P	—
	R 1/2	KQ2U12-04□P	—
Ø 16	R 1/4	KQ2U16-02□P	—
	R 3/8	KQ2U16-03□P	—
	R 1/2	KQ2U16-04□P	—



□/A: Brass, N: Brass + Electroless nickel plated

Double universal male elbow

KQ2VD

Use to branch a female thread at right angles.
Two individual parts rotate 360°.

Applicable tubing O.D. [mm]	Connection thread	Model	
		Round Type	Oval Type
Ø 4	R 1/8	KQ2VD04-01□P	KQ2VD04-01□P1
	R 1/4	KQ2VD04-02□P	KQ2VD04-02□P1
	R 3/8	KQ2VD04-03□P	KQ2VD04-03□P1
Ø 6	R 1/8	KQ2VD06-01□P	KQ2VD06-01□P1
	R 1/4	KQ2VD06-02□P	KQ2VD06-02□P1
	R 3/8	KQ2VD06-03□P	KQ2VD06-03□P1
Ø 8	R 1/8	KQ2VD08-01□P	—
	R 1/4	KQ2VD08-02□P	—
	R 3/8	KQ2VD08-03□P	—
	R 1/2	KQ2VD08-04□P	—
Ø 10	R 1/4	KQ2VD10-02□P	—
	R 3/8	KQ2VD10-03□P	—
	R 1/2	KQ2VD10-04□P	—
Ø 12	R 1/4	KQ2VD12-02□P	—
	R 3/8	KQ2VD12-03□P	—
	R 1/2	KQ2VD12-04□P	—



□/A: Brass, N: Brass + Electroless nickel plated
Note) Oval release button for p/n ended in -1.

Triple universal male elbow

KQ2VT

Use to three-branch a female thread at right angles.
Three individual parts rotate 360°.

Applicable tubing O.D. [mm]	Connection thread	Model	
		Round Type	Oval Type
Ø 4	R 1/8	KQ2VT04-01□P	KQ2VT04-01□P1
	R 1/4	KQ2VT04-02□P	KQ2VT04-02□P1
	R 3/8	KQ2VT04-03□P	KQ2VT04-03□P1
Ø 6	R 1/8	KQ2VT06-01□P	KQ2VT06-01□P1
	R 1/4	KQ2VT06-02□P	KQ2VT06-02□P1
	R 3/8	KQ2VT06-03□P	KQ2VT06-03□P1
Ø 8	R 1/8	KQ2VT08-01□P	—
	R 1/4	KQ2VT08-02□P	—
	R 3/8	KQ2VT08-03□P	—
	R 1/2	KQ2VT08-04□P	—
Ø 10	R 1/4	KQ2VT10-02□P	—
	R 3/8	KQ2VT10-03□P	—
	R 1/2	KQ2VT10-04□P	—
Ø 12	R 1/4	KQ2VT12-02□P	—
	R 3/8	KQ2VT12-03□P	—
	R 1/2	KQ2VT12-04□P	—



□/A: Brass, N: Brass + Electroless nickel plated
Note) Oval release button for p/n ended in -1.

Note) For dimensions and other details refer to specific catalogue of the series at www.smc.eu

- KQ2
- KQ2-Uni
- KQB2
- KS/KX
- KM
- KF
- M
- H/DL L/LL
- KC
- KK
- KKH
- KK 130
- DM
- DMK
- KDM
- MQR
- KB
- KR-W2
- KRM
- KA
- KQG2
- KG
- KFG2
- MS
- KKA
- KP
- KPQ/KPG
- LQ1
- LQ3
- LQHB



Male branch connector

KQ2LU

Use to branch a female thread at right angles.

Applicable tubing O.D. [mm]	Connection thread	Model
Ø 4	R 1/8	KQ2LU04-01□P
	R 1/4	KQ2LU04-02□P
Ø 6	R 1/8	KQ2LU06-01□P
	R 1/4	KQ2LU06-02□P
	R 3/8	KQ2LU06-03□P
Ø 8	R 1/8	KQ2LU08-01□P
	R 1/4	KQ2LU08-02□P
	R 3/8	KQ2LU08-03□P
Ø 10	R 1/4	KQ2LU10-02□P
	R 3/8	KQ2LU10-03□P
	R 1/2	KQ2LU10-04□P
Ø 12	R 1/4	KQ2LU12-02□P
	R 3/8	KQ2LU12-03□P
	R 1/2	KQ2LU12-04□P



□/A: Brass, N: Brass + Electroless nickel plated

Double branch universal male elbow

KQ2ZD

Use to four-branch a female thread at right angles. Two individual parts rotate 360°.

Applicable tubing O.D. [mm]	Connection thread	Model
Ø 4	R 1/8	KQ2ZD04-01□P
	R 1/4	KQ2ZD04-02□P
	R 3/8	KQ2ZD04-03□P
Ø 6	R 1/8	KQ2ZD06-01□P
	R 1/4	KQ2ZD06-02□P
	R 3/8	KQ2ZD06-03□P
Ø 8	R 1/8	KQ2ZD08-01□P
	R 1/4	KQ2ZD08-02□P
	R 3/8	KQ2ZD08-03□P
	R 1/2	KQ2ZD08-04□P
Ø 10	R 1/4	KQ2ZD10-02□P
	R 3/8	KQ2ZD10-03□P
	R 1/2	KQ2ZD10-04□P
Ø 12	R 1/4	KQ2ZD12-02□P
	R 3/8	KQ2ZD12-03□P
	R 1/2	KQ2ZD12-04□P



□/A: Brass, N: Brass + Electroless nickel plated

Branch universal male elbow

KQ2Z

Hexagon head of the body allows tightening with a box wrench. Use for branch connections.

Applicable tubing O.D. [mm]	Connection thread	Model
Ø 4	R 1/8	KQ2Z04-01□P
Ø 6	R 1/8	KQ2Z06-01□P
	R 1/4	KQ2Z06-02□P
	R 3/8	KQ2Z06-03□P
Ø 8	R 1/8	KQ2Z08-01□P
	R 1/4	KQ2Z08-02□P
	R 3/8	KQ2Z08-03□P
Ø 10	R 1/4	KQ2Z10-02□P
	R 3/8	KQ2Z10-03□P
Ø 12	R 3/8	KQ2Z12-03□P
	R 1/2	KQ2Z12-04□P



□/A: Brass, N: Brass + Electroless nickel plated

Triple branch universal male elbow

KQ2ZT

Use to six-branch a female thread at right angles. Three individual parts rotate 360°.

Applicable tubing O.D. [mm]	Connection thread	Model
Ø 4	R 1/8	KQ2ZT04-01□P
	R 1/4	KQ2ZT04-02□P
	R 3/8	KQ2ZT04-03□P
Ø 6	R 1/8	KQ2ZT06-01□P
	R 1/4	KQ2ZT06-02□P
	R 3/8	KQ2ZT06-03□P
Ø 8	R 1/8	KQ2ZT08-01□P
	R 1/4	KQ2ZT08-02□P
	R 3/8	KQ2ZT08-03□P
	R 1/2	KQ2ZT08-04□P
Ø 10	R 1/4	KQ2ZT10-02□P
	R 3/8	KQ2ZT10-03□P
	R 1/2	KQ2ZT10-04□P
Ø 12	R 1/4	KQ2ZT12-02□P
	R 3/8	KQ2ZT12-03□P
	R 1/2	KQ2ZT12-04□P



□/A: Brass, N: Brass + Electroless nickel plated

Note) For dimensions and other details refer to specific catalogue of the series at www.smc.eu



Double branch “Y”

KQ2UD

Use to four-branch tubing with size reduced.



Applicable tubing O.D. [mm]	Connection thread	Model
Ø 4	R 1/8	KQ2UD04-01□P
	R 1/4	KQ2UD04-02□P
Ø 6	R 1/8	KQ2UD06-01□P
	R 1/4	KQ2UD06-02□P

□/A: Brass, N: Brass + Electroless nickel plated

Male delta union

KQ2D

Use to branch a female thread at two right angles.



Applicable tubing O.D. [mm]	Connection thread	Model	
		Round Type	Oval Type
Ø 4	R 1/8	KQ2D04-01□P	KQ2D04-01□P1
	R 1/4	KQ2D04-02□P	KQ2D04-02□P1
Ø 6	R 1/8	KQ2D06-01□P	KQ2D06-01□P1
	R 1/4	KQ2D06-02□P	KQ2D06-02□P1
	R 3/8	KQ2D06-03□P	KQ2D06-03□P1
Ø 8	R 1/8	KQ2D08-01□P	—
	R 1/4	KQ2D08-02□P	—
	R 3/8	KQ2D08-03□P	—
Ø 10	R 1/4	KQ2D10-02□P	—
	R 3/8	KQ2D10-03□P	—
	R 1/2	KQ2D10-04□P	—
Ø 12	R 1/4	KQ2D12-02□P	—
	R 3/8	KQ2D12-03□P	—
	R 1/2	KQ2D12-04□P	—

□/A: Brass, N: Brass + Electroless nickel plated

Note) Oval release button for p/n ended in -1.

Note) For dimensions and other details refer to specific catalogue of the series at www.smc.eu

KQ2

KQ2-Uni

KQB2

KS/KX

KM

KF

M

H/DL
L/LL

KC

KK

KKH

KK
130

DM

DMK

KDM

MQR

KB

KR
-W2

KRM

KA

KQG2

KG

KFG2

MS

KKA

KP

KPQ/
KPG

LQ1

LQ3

LQHB



Universal female elbow

KQ2VF

Use to branch a male or female thread at a 90° angle. Multiple connections possible.



Applicable tubing O.D. [mm]	Connection thread	Model	
		Round Type	Oval Type
Ø 4	R, Rc 1/8	KQ2VF04-01□P	KQ2VF04-01□P1
	R, Rc 1/4	KQ2VF04-02□P	KQ2VF04-02□P1
Ø 6	R, Rc 1/8	KQ2VF06-01□P	KQ2VF06-01□P1
	R, Rc 1/4	KQ2VF06-02□P	KQ2VF06-02□P1
Ø 8	R, Rc 1/8	KQ2VF08-01□P	—
	R, Rc 1/4	KQ2VF08-02□P	—
	R, Rc 3/8	KQ2VF08-03□P	—
Ø 10	R, Rc 1/4	KQ2VF10-02□P	—
	R, Rc 3/8	KQ2VF10-03□P	—
Ø 12	R, Rc 3/8	KQ2VF12-03□P	—
	R, Rc 1/2	KQ2VF12-04□P	—

□/A: Brass, N: Brass + Electroless nickel plated
Note) Oval release button for p/n ended in -1.

Branch universal female elbow

KQ2ZF

Use to two-branch a male or female thread at a 90° angle. Multiple connections possible.



Applicable tubing O.D. [mm]	Connection thread	Model
Ø 4	R, Rc 1/8	KQ2ZF04-01□P
	R, Rc 1/4	KQ2ZF04-02□P
Ø 6	R, Rc 1/8	KQ2ZF06-01□P
	R, Rc 1/4	KQ2ZF06-02□P
Ø 8	R, Rc 1/8	KQ2ZF08-01□P
	R, Rc 1/4	KQ2ZF08-02□P
Ø 10	R, Rc 1/4	KQ2ZF10-02□P
	R, Rc 3/8	KQ2ZF10-03□P
Ø 12	R, Rc 3/8	KQ2ZF12-03□P
	R, Rc 1/2	KQ2ZF12-04□P

□/A: Brass, N: Brass + Electroless nickel plated

Accessories

Face Seal One-touch Fittings

KQ2 Series

Adaptor

KQ2N

Use to connect One-touch fittings and R female thread.



Applicable fitting size	Connection thread	Model
Ø 4	R 1/8	KQ2N04-01□P
	R 1/4	KQ2N04-02□P
Ø 6	R 1/8	KQ2N06-01□P
	R 1/4	KQ2N06-02□P
Ø 8	R 1/4	KQ2N08-02□P
	R 3/8	KQ2N08-03□P
Ø 10	R 3/8	KQ2N10-03□P

□/A: Brass, N: Brass + Electroless nickel plated

Note) For dimensions and other details refer to specific catalogue of the series at www.smc.eu

Face Seal One-touch Fittings

RoHS

Fittings

KQ2 Series

■ Applicable tubing O.D. : Metric Size

■ Connection thread : G

Applicable to parallel pipe thread (G).

New thread for piping that drastically reduced the screw-in time thanks to the face seal method.



Applicable Tubing

Tubing material	FEP, PFA, Nylon, Soft nylon, Polyurethane
Tubing O.D.	Ø 4, Ø 6, Ø 8, Ø 10, Ø 12, Ø 16

Note) Oval release button for Ø 4, Ø 6

Specifications

Fluid	Air/Water ^{Note 1)}	
Operating pressure range ^{Note 2)}	-100 kPa to 1 MPa	
Proof pressure (at 23 °C)	3 MPa	
Ambient and fluid temperature	-5 to 60 °C, Water: 0 to 40 °C (No freezing)	
Thread	Mounting section	ISO 16030 (Parallel pipe thread)
	Nut section	JIS B0205 (Metric fine thread)
Seal on the threads	Seal ring	

Note 1) The surge pressure must be under the maximum operating pressure.

Note 2) Do not use the fittings with a leak tester or for vacuum retention because they are not guaranteed for zero leakage.

Guide

Chuck

Suitable for use with nylon and urethane. Large retaining force.

The chuck provides secure retention and the collet increases the holding force on the tube.

Seal

Can be used for a wide range of pressures from a low vacuum up to a pressure of 1 MPa.

The use of a special profile ensures sealing and reduces resistance when the tube is inserted.

Face seal method

Seal ring

Piping installability is improved by changing to the face seal structure.



Release button

Requires little force for removal.

Releases the chuck collet to remove the tube as well as to prevent the chuck from biting too deeply into the tubing.

Body

O-ring

Stud

Effective when piping in a confined space.

The body and the threaded portion can rotate (for positioning to some extent).

G thread

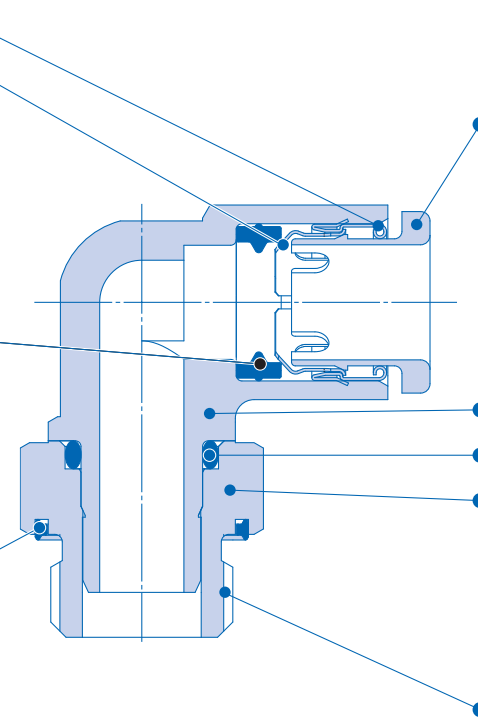

KQ2

KQ2-Uni

KQB2

KS/KX

KM

KF

M

H/DL
L/LL

KC

KK

KKH

KK
130

DM

DMK

KDM

MQR

KB

KR
-W2

KRM

KA

KQG2

KG

KFG2

MS

KKA

KP











KPQ/
KPG

LQ1

LQ3

LQHB

Oval type variations

Tubing  Female thread hole		
KQ2S Hexagon socket head male connector  P.60	KQ2F Female connector  P.62	KQ2L Male elbow  P.60
KQ2W Extended male elbow  P.60	KQ2V Universal male elbow  P.61	KQ2T Male elbow tee  P.61
KQ2H Male connector  P.60	KQ2E Bulkhead connector  P.62	KQ2Y Male run tee  P.61



Male connector

KQ2H

Use to pipe a female thread.
Most general model.

Applicable tubing O.D. [mm]	Connection thread	Model	
		Round Type	Oval Type
Ø 4	G 1/8	KQ2H04-G01□	KQ2H04-G01□1
	G 1/4	KQ2H04-G02□	KQ2H04-G02□1
Ø 6	G 1/8	KQ2H06-G01□	KQ2H06-G01□1
	G 1/4	KQ2H06-G02□	KQ2H06-G02□1
	G 3/8	KQ2H06-G03□	KQ2H06-G03□1
Ø 8	G 1/8	KQ2H08-G01□	—
	G 1/4	KQ2H08-G02□	—
	G 3/8	KQ2H08-G03□	—
Ø 10	G 1/8	KQ2H10-G01□	—
	G 1/4	KQ2H10-G02□	—
	G 3/8	KQ2H10-G03□	—
	G 1/2	KQ2H10-G04□	—
Ø 12	G 1/4	KQ2H12-G02□	—
	G 3/8	KQ2H12-G03□	—
	G 1/2	KQ2H12-G04□	—
Ø 16	G 3/8	KQ2H16-G03□	—
	G 1/2	KQ2H16-G04□	—

□/A: Brass, N: Brass + Electroless nickel plated
Note) Oval release button for p/n ended in -1.



Male elbow

KQ2L

Use to pipe a female thread at right angles.
Most general model.

Applicable tubing O.D. [mm]	Connection thread	Model	
		Round Type	Oval Type
Ø 4	G 1/8	KQ2L04-G01□	KQ2L04-G01□1
	G 1/4	KQ2L04-G02□	KQ2L04-G02□1
Ø 6	G 1/8	KQ2L06-G01□	KQ2L06-G01□1
	G 1/4	KQ2L06-G02□	KQ2L06-G02□1
	G 3/8	KQ2L06-G03□	KQ2L06-G03□1
Ø 8	G 1/8	KQ2L08-G01□	—
	G 1/4	KQ2L08-G02□	—
	G 3/8	KQ2L08-G03□	—
Ø 10	G 1/8	KQ2L10-G01□	—
	G 1/4	KQ2L10-G02□	—
	G 3/8	KQ2L10-G03□	—
	G 1/2	KQ2L10-G04□	—
Ø 12	G 1/4	KQ2L12-G02□	—
	G 3/8	KQ2L12-G03□	—
	G 1/2	KQ2L12-G04□	—
Ø 16	G 3/8	KQ2L16-G03□	—
	G 1/2	KQ2L16-G04□	—

□/A: Brass, N: Brass + Electroless nickel plated
Note) Oval release button for p/n ended in -1.



Hexagon socket head male connector

KQ2S

Internal hexagon socket allows tightening with a hexagon wrench in confined spaces.

Applicable tubing O.D. [mm]	Connection thread	Model	
		Round Type	Oval Type
Ø 4	G 1/8	KQ2S04-G01□	KQ2S04-G01□1
Ø 6	G 1/8	KQ2S06-G01□	KQ2S06-G01□1
	G 1/4	KQ2S06-G02□	KQ2S06-G02□1
Ø 8	G 1/8	KQ2S08-G01□	—
	G 1/4	KQ2S08-G02□	—
	G 3/8	KQ2S08-G03□	—
Ø 10	G 1/8	KQ2S10-G01□	—
	G 1/4	KQ2S10-G02□	—
	G 3/8	KQ2S10-G03□	—
	G 1/2	KQ2S10-G04□	—
Ø 12	G 1/4	KQ2S12-G02□	—
	G 3/8	KQ2S12-G03□	—
	G 1/2	KQ2S12-G04□	—
Ø 16	G 3/8	KQ2S16-G03□	—
	G 1/2	KQ2S16-G04□	—

□/A: Brass, N: Brass + Electroless nickel plated
Note) Oval release button for p/n ended in -1.



Extended male elbow

KQ2W

Basically, it is used together with male elbow.
Different point is that it is used for fittings to avoid interfering with each other by making the piping multi-level.

Applicable tubing O.D. [mm]	Connection thread	Model	
		Round Type	Oval Type
Ø 4	G 1/8	KQ2W04-G01□	KQ2W04-G01□1
	G 1/4	KQ2W04-G02□	KQ2W04-G02□1
Ø 6	G 1/8	KQ2W06-G01□	KQ2W06-G01□1
	G 1/4	KQ2W06-G02□	KQ2W06-G02□1
	G 3/8	KQ2W06-G03□	KQ2W06-G03□1
Ø 8	G 1/8	KQ2W08-G01□	—
	G 1/4	KQ2W08-G02□	—
	G 3/8	KQ2W08-G03□	—
Ø 10	G 1/4	KQ2W10-G02□	—
	G 3/8	KQ2W10-G03□	—
	G 1/2	KQ2W10-G04□	—
	G 1/4	KQ2W12-G02□	—
Ø 12	G 3/8	KQ2W12-G03□	—
	G 1/2	KQ2W12-G04□	—
	G 3/8	KQ2W16-G03□	—
Ø 16	G 1/2	KQ2W16-G04□	—

□/A: Brass, N: Brass + Electroless nickel plated
Note) Oval release button for p/n ended in -1.



Note) For dimensions and other details refer to specific catalogue of the series at www.smc.eu



Universal male elbow

KQ2V

Hexagon head of the body allows tightening with a box wrench in confined spaces.

Applicable tubing O.D. [mm]	Connection thread	Model	
		Round Type	Oval Type
Ø 4	G 1/8	KQ2V04-G01□	KQ2V04-G01□1
	G 1/4	KQ2V04-G02□	KQ2V04-G02□1
Ø 6	G 1/8	KQ2V06-G01□	KQ2V06-G01□1
	G 1/4	KQ2V06-G02□	KQ2V06-G02□1
Ø 8	G 1/8	KQ2V08-G01□	—
	G 1/4	KQ2V08-G02□	—
	G 3/8	KQ2V08-G03□	—
Ø 10	G 1/4	KQ2V10-G02□	—
	G 3/8	KQ2V10-G03□	—
Ø 12	G 3/8	KQ2V12-G03□	—
	G 1/2	KQ2V12-G04□	—
Ø 16	G 3/8	KQ2V16-G03□	—
	G 1/2	KQ2V16-G04□	—



□/A: Brass, N: Brass + Electroless nickel plated
Note) Oval release button for p/n ended in -1.

Male run tee

KQ2Y

Use to branch a female thread at a 90° angle.

Applicable tubing O.D. [mm]	Connection thread	Model	
		Round Type	Oval Type
Ø 4	G 1/8	KQ2Y04-G01□	KQ2Y04-G01□1
	G 1/4	KQ2Y04-G02□	KQ2Y04-G02□1
Ø 6	G 1/8	KQ2Y06-G01□	KQ2Y06-G01□1
	G 1/4	KQ2Y06-G02□	KQ2Y06-G02□1
	G 3/8	KQ2Y06-G03□	KQ2Y06-G03□1
Ø 8	G 1/8	KQ2Y08-G01□	—
	G 1/4	KQ2Y08-G02□	—
	G 3/8	KQ2Y08-G03□	—
Ø 10	G 1/8	KQ2Y10-G01□	—
	G 1/4	KQ2Y10-G02□	—
	G 3/8	KQ2Y10-G03□	—
	G 1/2	KQ2Y10-G04□	—
Ø 12	G 1/4	KQ2Y12-G02□	—
	G 3/8	KQ2Y12-G03□	—
	G 1/2	KQ2Y12-G04□	—
Ø 16	G 3/8	KQ2Y16-G03□	—
	G 1/2	KQ2Y16-G04□	—



□/A: Brass, N: Brass + Electroless nickel plated
Note) Oval release button for p/n ended in -1.

Male elbow tee

KQ2T

Use to branch a female thread at both 90° angles.

Applicable tubing O.D. [mm]	Connection thread	Model	
		Round Type	Oval Type
Ø 4	G 1/8	KQ2T04-G01□	KQ2T04-G01□1
	G 1/4	KQ2T04-G02□	KQ2T04-G02□1
Ø 6	G 1/8	KQ2T06-G01□	KQ2T06-G01□1
	G 1/4	KQ2T06-G02□	KQ2T06-G02□1
Ø 8	G 3/8	KQ2T06-G03□	KQ2T06-G03□1
	G 1/8	KQ2T08-G01□	—
Ø 10	G 1/4	KQ2T08-G02□	—
	G 3/8	KQ2T08-G03□	—
	G 1/8	KQ2T10-G01□	—
Ø 12	G 1/4	KQ2T10-G02□	—
	G 3/8	KQ2T10-G03□	—
	G 1/2	KQ2T10-G04□	—
Ø 16	G 1/4	KQ2T12-G02□	—
	G 3/8	KQ2T12-G03□	—
Ø 16	G 1/2	KQ2T12-G04□	—
	G 3/8	KQ2T16-G03□	—
Ø 16	G 1/2	KQ2T16-G04□	—



□/A: Brass, N: Brass + Electroless nickel plated
Note) Oval release button for p/n ended in -1.

Note) For dimensions and other details refer to specific catalogue of the series at www.smc.eu

Female connector

KQ2F

Use to pipe a male thread.
Most general model.

Applicable tubing O.D. [mm]	Connection thread	Model	
		Round Type	Oval Type
Ø 4	G 1/8	KQ2F04-G01□	KQ2F04-G01□1
	G 1/4	KQ2F04-G02□	KQ2F04-G02□1
Ø 6	G 1/8	KQ2F06-G01□	KQ2F06-G01□1
	G 1/4	KQ2F06-G02□	KQ2F06-G02□1
	G 3/8	KQ2F06-G03□	KQ2F06-G03□1
Ø 8	G 1/8	KQ2F08-G01□	—
	G 1/4	KQ2F08-G02□	—
	G 3/8	KQ2F08-G03□	—
Ø 10	G 1/4	KQ2F10-G02□	—
	G 3/8	KQ2F10-G03□	—
Ø 12	G 1/4	KQ2F12-G02□	—
	G 3/8	KQ2F12-G03□	—
	G 1/2	KQ2F12-G04□	—
Ø 16	G 3/8	KQ2F16-G03□	—
	G 1/2	KQ2F16-G04□	—



□/A: Brass, N: Brass + Electroless nickel plated
Note) Oval release button for p/n ended in -1.

Adaptor

KQ2E

Use to connect tubing through a panel, etc.

Applicable tubing O.D. [mm]	Connection thread	Model	
		Round Type	Oval Type
Ø 4	G 1/8	KQ2E04-G01□	KQ2E04-G01□1
	G 1/4	KQ2E04-G02□	KQ2E04-G02□1
Ø 6	G 1/8	KQ2E06-G01□	KQ2E06-G01□1
	G 1/4	KQ2E06-G02□	KQ2E06-G02□1
	G 3/8	KQ2E06-G03□	KQ2E06-G03□1
Ø 8	G 1/8	KQ2E08-G01□	—
	G 1/4	KQ2E08-G02□	—
	G 3/8	KQ2E08-G03□	—
Ø 10	G 1/4	KQ2E10-G02□	—
	G 3/8	KQ2E10-G03□	—
Ø 12	G 3/8	KQ2E12-G03□	—
	G 1/2	KQ2E12-G04□	—
Ø 16	G 3/8	KQ2E16-G03□	—
	G 1/2	KQ2E16-G04□	—



□/A: Brass, N: Brass + Electroless nickel plated
Note) Oval release button for p/n ended in -1.

Spare Parts

Brass

Description	Part no.	Applicable model
Pipe nut	KQ04-P01A	KQ2E04-G01A, KQ2E04-G02A
	KQ06-P01A	KQ2E06-G01A, KQ2E06-G02A, KQ2E06-G03A
	KQ08-P01A	KQ2E08-G01A, KQ2E08-G02A, KQ2E08-G03A
	KQ10-P01A	KQ2E10-G02A, KQ2E10-G03A
	KQ12-P01A	KQ2E12-G03A, KQ2E12-G04A
	KQ16-P01A	KQ2E16-G03A, KQ2E16-G04A

Brass + Electroless nickel plated

Description	Part no.	Applicable model
Pipe nut	KQ04-P01N	KQ2E04-G01N, KQ2E04-G02N
	KQ06-P01N	KQ2E06-G01N, KQ2E06-G02N, KQ2E06-G03N
	KQ08-P01N	KQ2E08-G01N, KQ2E08-G02N, KQ2E08-G03N
	KQ10-P01N	KQ2E10-G02N, KQ2E10-G03N
	KQ12-P01N	KQ2E12-G03N, KQ2E12-G04N
	KQ16-P01N	KQ2E16-G03N, KQ2E16-G04N

Brass for oval type

Description	Part no.	Applicable model
Pipe nut	KQ04-P01A	KQ2E04-G01A1, KQ2E04-G02A1
	KQ16-P01A	KQ2E06-G01A1, KQ2E06-G02A1, KQ2E06-G03A1

Brass + Electroless nickel plated for oval type

Description	Part no.	Applicable model
Pipe nut	KQ04-P01N	KQ2E04-G01N1, KQ2E04-G02N1
	KQ06-P01N	KQ2E06-G01N1, KQ2E06-G02N1, KQ2E06-G03N1

Note) For dimensions and other details refer to specific catalogue of the series at www.smc.eu

- KQ2
- KQ2-Uni
- KQB2
- KS/KX
- KM
- KF
- M
- H/DL L/LL
- KC
- KK
- KKH
- KK 130
- DM
- DMK
- KDM
- MQR
- KB
- KR-W2
- KRM
- KA
- KQG2
- KG
- KFG2
- MS
- KKA
- KP
- KPQ/KPG
- LQ1
- LQ3
- LQHB

KQ2 Series

- Applicable tubing O.D. : **Metric Size**
- Connection thread : **Rc, G, NPT, NPTF**

New-stand male thread for piping that reduces the screw-in time by 1/3.

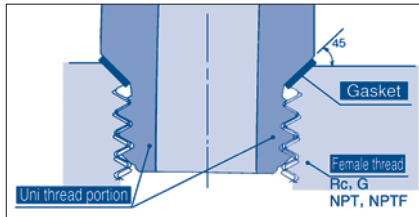

Uni thread ridge shape

A gasket made of a stainless sheet covered with laminated NBR on both sides is seated on the chamfer of a female thread for a perfect sealing construction irrespective of the difference in thread diameters due to the difference in the types of female threads, variation in tolerance, or difference in the size of chamfer. (It is applicable to any female thread with an ordinary chamfer.)

A ridge shape has been created as a Uni thread for common applications for Rc, G, NPT and NPTF.

The male thread for piping drastically cuts piping manhours.



Applicable Tubing

Tubing material	FEP, PFA, Nylon, Soft nylon, Polyurethane
Tubing O.D.	Ø 4, Ø 6, Ø 8, Ø 10, Ø 12, Ø 16

Note) Oval release button for Ø 4, Ø 6.

Specifications







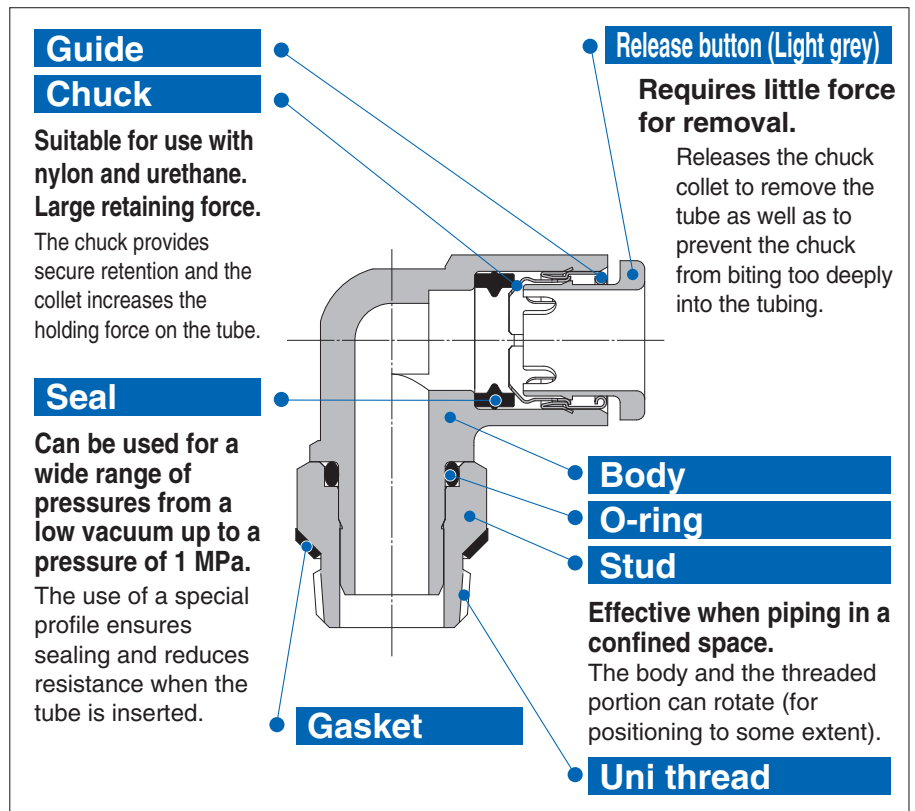



Fluid	Air/Water ^{Note 1)}
Operating pressure range ^{Note 2)}	-100 kPa to 1 MPa
Proof pressure (at 23 °C)	3 MPa
Ambient and fluid temperature	-5 to 60 °C, Water: 0 to 40 °C (No freezing)

Note 1) The surge pressure must be under the maximum operating pressure.

Note 2) Do not use the fittings with a leak tester or for vacuum retention because they are not guaranteed for zero leakage.



Note) For inch size, refer to the **WEB catalogue** at www.smc.eu

Tubing  Female thread hole		
KQ2H Male connector  <ul style="list-style-type: none"> • Oval • Round <p>P.65</p>	KQ2K 45° male elbow  <ul style="list-style-type: none"> • Oval • Round <p>P.66</p>	KQ2T Male branch tee  <ul style="list-style-type: none"> • Oval • Round <p>P.65</p>
KQ2S Hexagon socket head male connector  <ul style="list-style-type: none"> • Oval • Round <p>P.66</p>	KQ2W Extended male elbow  <ul style="list-style-type: none"> • Oval • Round <p>P.66</p>	KQ2Y Male run tee  <ul style="list-style-type: none"> • Oval • Round <p>P.65</p>
KQ2L Male elbow  <ul style="list-style-type: none"> • Oval • Round <p>P.65</p>	KQ2V Universal male elbow  <ul style="list-style-type: none"> • Oval • Round <p>P.66</p>	KQ2U Branch "Y"  <ul style="list-style-type: none"> • Round <p>P.66</p>

Note) Oval release button for p/n ended in -1.

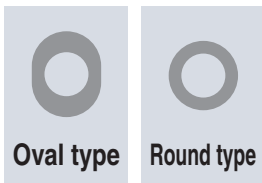

KQ2

KQ2-Uni

KQB2

KS/KX

KM

KF

M

H/DL
L/LL

KC

KK

KKH

KK
130

DM

DMK

KDM

MQR

KB

KR
-W2

KRM

KA

KQG2

KG

KFG2

MS

KKA

KP

KPQ/
KPG

LQ1

LQ3

LQHB



Male connector

KQ2H

Use to pipe a female thread.
Most general model.

Applicable tubing O.D. [mm]	Connection thread	Model	
		Round Type	Oval Type
Ø 4	Uni 1/8	KQ2H04-U01□	KQ2H04-U01□1
	Uni 1/4	KQ2H04-U02□	KQ2H04-U02□1
Ø 6	Uni 1/8	KQ2H06-U01□	KQ2H06-U01□1
	Uni 1/4	KQ2H06-U02□	KQ2H06-U02□1
	Uni 3/8	KQ2H06-U03□	KQ2H06-U03□1
Ø 8	Uni 1/8	KQ2H08-U01□	—
	Uni 1/4	KQ2H08-U02□	—
	Uni 3/8	KQ2H08-U03□	—
Ø 10	Uni 1/8	KQ2H10-U01□	—
	Uni 1/4	KQ2H10-U02□	—
	Uni 3/8	KQ2H10-U03□	—
	Uni 1/2	KQ2H10-U04□	—
Ø 12	Uni 1/4	KQ2H12-U02□	—
	Uni 3/8	KQ2H12-U03□	—
	Uni 1/2	KQ2H12-U04□	—
Ø 16	Uni 3/8	KQ2H16-U03□	—
	Uni 1/2	KQ2H16-U04□	—



□/A: Brass, N: Brass + Electroless nickel plated
Note) Oval release button for p/n ended in -1.

Male branch tee

KQ2T

Use to branch a female thread at both 90° angles.

Applicable tubing O.D. [mm]	Connection thread	Model	
		Round Type	Oval Type
Ø 4	Uni 1/8	KQ2T04-U01□	KQ2T04-U01□1
	Uni 1/4	KQ2T04-U02□	KQ2T04-U02□1
Ø 6	Uni 1/8	KQ2T06-U01□	KQ2T06-U01□1
	Uni 1/4	KQ2T06-U02□	KQ2T06-U02□1
	Uni 3/8	KQ2T06-U03□	KQ2T06-U03□1
Ø 8	Uni 1/8	KQ2T08-U01□	KQ2T08-U01□Q*3
	Uni 1/4	KQ2T08-U02□	—
	Uni 3/8	KQ2T08-U03□	—
Ø 10	Uni 1/8	KQ2T10-U01□	—
	Uni 1/4	KQ2T10-U02□	—
	Uni 3/8	KQ2T10-U03□	—
	Uni 1/2	KQ2T10-U04□	—
Ø 12	Uni 1/4	KQ2T12-U02□	—
	Uni 3/8	KQ2T12-U03□	—
	Uni 1/2	KQ2T12-U04□	—
Ø 16	Uni 3/8	KQ2T16-U03□	—
	Uni 1/2	KQ2T16-U04□	—



□/A: Brass, N: Brass + Electroless nickel plated
*3) For details refer P.48
Note) Oval release button for p/n ended in -1.

Male elbow

KQ2L

Use to pipe a female thread at right angles.
Most general model.

Applicable tubing O.D. [mm]	Connection thread	Model	
		Round Type	Oval Type
Ø 4	Uni 1/8	KQ2L04-U01□	KQ2L04-U01□1
	Uni 1/4	KQ2L04-U02□	KQ2L04-U02□1
Ø 6	Uni 1/8	KQ2L06-U01□	KQ2L06-U01□1
	Uni 1/4	KQ2L06-U02□	KQ2L06-U02□1
	Uni 3/8	KQ2L06-U03□	KQ2L06-U03□1
Ø 8	Uni 1/8	KQ2L08-U01□	KQ2L08-U01□Q*3
	Uni 1/4	KQ2L08-U02□	—
	Uni 3/8	KQ2L08-U03□	—
Ø 10	Uni 1/8	KQ2L10-U01□	—
	Uni 1/4	KQ2L10-U02□	—
	Uni 3/8	KQ2L10-U03□	—
	Uni 1/2	KQ2L10-U04□	—
Ø 12	Uni 1/4	KQ2L12-U02□	—
	Uni 3/8	KQ2L12-U03□	—
	Uni 1/2	KQ2L12-U04□	—
Ø 16	Uni 3/8	KQ2L16-U03□	—
	Uni 1/2	KQ2L16-U04□	—



□/A: Brass, N: Brass + Electroless nickel plated
*3) For details refer P.48
Note) Oval release button for p/n ended in -1.

Male run tee

KQ2Y

Use to branch a female thread at a 90° angle.

Applicable tubing O.D. [mm]	Connection thread	Model	
		Round Type	Oval Type
Ø 4	Uni 1/8	KQ2Y04-U01□	KQ2Y04-U01□1
	Uni 1/4	KQ2Y04-U02□	KQ2Y04-U02□1
Ø 6	Uni 1/8	KQ2Y06-U01□	KQ2Y06-U01□1
	Uni 1/4	KQ2Y06-U02□	KQ2Y06-U02□1
	Uni 3/8	KQ2Y06-U03□	KQ2Y06-U03□1
Ø 8	Uni 1/8	KQ2Y08-U01□	KQ2Y08-U01□Q*3
	Uni 1/4	KQ2Y08-U02□	—
	Uni 3/8	KQ2Y08-U03□	—
Ø 10	Uni 1/8	KQ2Y10-U01□	—
	Uni 1/4	KQ2Y10-U02□	—
	Uni 3/8	KQ2Y10-U03□	—
	Uni 1/2	KQ2Y10-U04□	—
Ø 12	Uni 1/4	KQ2Y12-U02□	—
	Uni 3/8	KQ2Y12-U03□	—
	Uni 1/2	KQ2Y12-U04□	—
Ø 16	Uni 3/8	KQ2Y16-U03□	—
	Uni 1/2	KQ2Y16-U04□	—



□/A: Brass, N: Brass + Electroless nickel plated
*3) For details refer P.48
Note) Oval release button for p/n ended in -1.

Note) For dimensions and other details refer to specific catalogue of the series at www.smc.eu



Branch "Y"

KQ2U

Use to branch a female thread.

Applicable tubing O.D. [mm]	Connection thread	Model	
		Round Type	Oval Type
Ø 4	Uni 1/8	KQ2U04-U01□	
	Uni 1/4	KQ2U04-U02□	
Ø 6	Uni 1/8	KQ2U06-U01□	
	Uni 1/4	KQ2U06-U02□	
	Uni 3/8	KQ2U06-U03□	
Ø 8	Uni 1/8	KQ2U08-U01□	
	Uni 1/4	KQ2U08-U02□	
	Uni 3/8	KQ2U08-U03□	
Ø 10	Uni 1/4	KQ2U10-U02□	
	Uni 3/8	KQ2U10-U03□	
	Uni 1/2	KQ2U10-U04□	
Ø 12	Uni 1/4	KQ2U12-U02□	
	Uni 3/8	KQ2U12-U03□	
	Uni 1/2	KQ2U12-U04□	



□/A: Brass, N: Brass + Electroless nickel plated

Extended male elbow

KQ2W

Basically, it is used together with male elbow. Different point is that it is used for fittings to avoid interfering with each other by making the piping multi-level.

Applicable tubing O.D. [mm]	Connection thread	Model	
		Round Type	Oval Type
Ø 4	Uni 1/8	KQ2W04-U01□	KQ2W04-U01□1
	Uni 1/4	KQ2W04-U02□	KQ2W04-U02□1
Ø 6	Uni 1/8	KQ2W06-U01□	KQ2W06-U01□1
	Uni 1/4	KQ2W06-U02□	KQ2W06-U02□1
	Uni 3/8	KQ2W06-U03□	KQ2W06-U03□1
Ø 8	Uni 1/8	KQ2W08-U01□	KQ2W08-U01□□*3
	Uni 1/4	KQ2W08-U02□	
	Uni 3/8	KQ2W08-U03□	
Ø 10	Uni 1/4	KQ2W10-U02□	
	Uni 3/8	KQ2W10-U03□	
	Uni 1/2	KQ2W10-U04□	
Ø 12	Uni 1/4	KQ2W12-U02□	
	Uni 3/8	KQ2W12-U03□	
	Uni 1/2	KQ2W12-U04□	



□/A: Brass, N: Brass + Electroless nickel plated
 Note) Oval release button for p/n ended in -1.
 *3) For details refer P.48

Note) For dimensions and other details refer to specific catalogue of the series at www.smc.eu

Hexagon socket head male connector

KQ2S

Internal hexagon socket allows tightening with a hexagon wrench in confined spaces.

Applicable tubing O.D. [mm]	Connection thread	Model	
		Round Type	Oval Type
Ø 4	Uni 1/8	KQ2S04-U01□	KQ2S04-U01□1
	Uni 1/4	KQ2S06-U01□	KQ2S06-U01□1
Ø 6	Uni 1/8	KQ2S06-U01□	KQ2S06-U01□1
	Uni 1/4	KQ2S06-U02□	KQ2S06-U02□1
Ø 8	Uni 1/8	KQ2S08-U01□	—
	Uni 1/4	KQ2S08-U02□	—
	Uni 3/8	KQ2S08-U03□	—
Ø 10	Uni 1/8	KQ2S10-U01□	—
	Uni 1/4	KQ2S10-U02□	—
	Uni 3/8	KQ2S10-U03□	—
Ø 12	Uni 1/2	KQ2S10-U04□	—
	Uni 1/4	KQ2S12-U02□	—
	Uni 3/8	KQ2S12-U03□	—
	Uni 1/2	KQ2S12-U04□	—



□/A: Brass, N: Brass + Electroless nickel plated
 Note) Oval release button for p/n ended in -1.

45° male elbow

KQ2K

Use to pipe a female thread at a 45° angle. The model between the male connector and male elbow.

Applicable tubing O.D. [mm]	Connection thread	Model	
		Round Type	Oval Type
Ø 4	Uni 1/8	KQ2K04-U01□	KQ2K04-U01□1
	Uni 1/4	KQ2K04-U02□	KQ2K04-U02□1
Ø 6	Uni 1/8	KQ2K06-U01□	KQ2K06-U01□1
	Uni 1/4	KQ2K06-U02□	KQ2K06-U02□1
	Uni 3/8	KQ2K06-U03□	KQ2K06-U03□1
Ø 8	Uni 1/8	KQ2K08-U01□	KQ2K08-U01□□*3
	Uni 1/4	KQ2K08-U02□	—
	Uni 3/8	KQ2K08-U03□	—
Ø 10	Uni 1/8	KQ2K10-U01□	—
	Uni 1/4	KQ2K10-U02□	—
	Uni 3/8	KQ2K10-U03□	—
Ø 12	Uni 1/2	KQ2K10-U04□	—
	Uni 1/4	KQ2K12-U02□	—
	Uni 3/8	KQ2K12-U03□	—
	Uni 1/2	KQ2K12-U04□	—



□/A: Brass, N: Brass + Electroless nickel plated
 Note) Oval release button for p/n ended in -1.
 *3) For details refer P.48

Universal male elbow

KQ2V

Hexagon head of the body allows tightening with a box wrench in confined spaces.

Applicable tubing O.D. [mm]	Connection thread	Model	
		Round Type	Oval Type
Ø 4	Uni 1/8	KQ2V04-U01□	KQ2V04-U01□1
	Uni 1/4	KQ2V06-U01□	KQ2V06-U01□1
Ø 6	Uni 1/8	KQ2V06-U01□	KQ2V06-U01□1
	Uni 1/4	KQ2V06-U02□	KQ2V06-U02□1
	Uni 3/8	KQ2V06-U03□	—
Ø 8	Uni 1/8	KQ2V08-U01□	—
	Uni 1/4	KQ2V08-U02□	—
	Uni 3/8	KQ2V08-U03□	—
Ø 10	Uni 1/4	KQ2V10-U02□	—
	Uni 3/8	KQ2V10-U03□	—
	Uni 1/2	KQ2V10-U04□	—
Ø 12	Uni 3/8	KQ2V12-U03□	—
	Uni 1/2	KQ2V12-U04□	—



□/A: Brass, N: Brass + Electroless nickel plated
 Note) Oval release button for p/n ended in -1.



Made to Order

1 Made to Order

Symbol	Specifications
X12	Lubricant: White vaseline Release button colour: White
X35 *1	Body colour: Black Release button colour: Light grey
X41	With fixed orifice*2
KQ2□08-U01□Q	Effective area is interchangeable with the current product (KQ series). Applicable model: Male elbow 45° male elbow Extended male elbow Male branch tee Male run tee Applicable tubing O.D./Port size: Ø 8/Uni 1/8 Thread material/Surface treatment: Brass, Brass + Electroless nickel plating Example) KQ2L08-U01AQ

*1 The following models are not available as made-to-order: Hexagon socket head male connector/KQ2S, Male connector/KQ2H

*2 Please contact SMC for availability.

The following made-to-order products will be provided based on previous models (KQ2 series). Please contact SMC separately.

Symbol	Specifications
X17	Grease-free Rubber material: NBR (With fluorine coating) Release button colour: Light blue
X29	Grease-free Rubber material: NBR (With fluorine coating) Release button colour: Light blue Copper-free (With electroless nickel plating)
X39	Grease-free Rubber material: NBR (With fluorine coating) Release button colour: Light blue Clean (Copper-free, air blow, double packaging, resin body: white)

2 Clean Series

Please consult with SMC separately for applicable models.

Symbol	Specifications
10-	Brass parts: With electroless nickel plated Lubricant: Fluorine grease Air blow in a clean room Double package Resin body/Release button colour: White

Example) **10-KQ2H06-U01N**

Spare Parts

Description	Part no.	Applicable thread
Gasket	KQG-U01	Uni 1/8
	KQG-U02	Uni 1/4
	KQG-U03	Uni 3/8
	KQG-U04	Uni 1/2

Metal One-touch Fittings

RoHS

Fittings

KQB2 Series

■ Applicable tubing O.D. : Metric Size

■ Connection thread : M5, R, Rc

Heat Resistant

Spatter Proof

Fluid temperature: -5 to 150 °C

Grease-free

Applicable tubing material:

- FEP • PFA • Nylon
- Soft nylon
- Polyurethane
- Polyolefin

Electroless nickel plated (Brass parts)



Applicable Tubing

Tubing material	FEP, PFA, Nylon, Soft nylon ^{Note 1)} , Polyurethane, Polyolefin
Tubing O.D.	Ø 3.2, Ø 4, Ø 6, Ø 8, Ø 10, Ø 12, Ø 16

Specifications

Fluid	Air/Water
Operating pressure range ^{Note 2)}	-100 kPa to 1 MPa ^{Note 3)}
Proof pressure	3.0 MPa
Ambient and fluid temperature ^{Note 4)}	-5 to 150 °C (No freezing) ^{Note 3)}
Lubricant	Grease-free specification
Seal on the threads	With sealant

Note 1) For soft nylon tubing, water cannot be used.

Note 2) Avoid using in a vacuum holding application such as a leak tester, since there is leakage.

Note 3) Check the operating pressure range and operating temperature range of the tubing.

Note 4) It is recommended that you use the inner sleeve in the following conditions (Except Ø 3.2)

- When using in an environment where the fluid temperature changes drastically.
- When using at a high temperature.

* Temperature Condition of Mounting the Inner Sleeve

Tubing	Temperature
FEP tubing/Series TH	80 °C or more
Super PFA tubing/Series TL	120 °C or more

Cross Reference Table of the Inner Sleeve

Tubing O.D.	Tubing material			Applicable inner sleeve	
	TUS (Soft polyurethane)	TH/TH (FEP)	TL/TIL (PFA)	Part no.	Length [mm]
Ø 4	—	TH0402	—	TJ-0402	18
	TUS0425	TH0425	—	TJ-0425	18
	—	—	TL0403	TJ-0403	18
Ø 6	TUS0604	TH0604	TL0604	TJ-0604	19
	TUS0805	—	—	TJ-0805	20.5
Ø 8	—	TH0806	TL0806	TJ-0806	20.5
	TUS1065	—	—	TJ-1065	23
Ø 10	—	TH1075	—	TJ-1075	23
	—	TH1008	TL1008	TJ-1008	24
	TUS1208	—	—	TJ-1208	24
Ø 12	—	TH1209	—	TJ-1209	24
	—	TH1210	TL1210	TJ-1210	24

* C2700 + Electroless nickel plated is used for the TJ series.

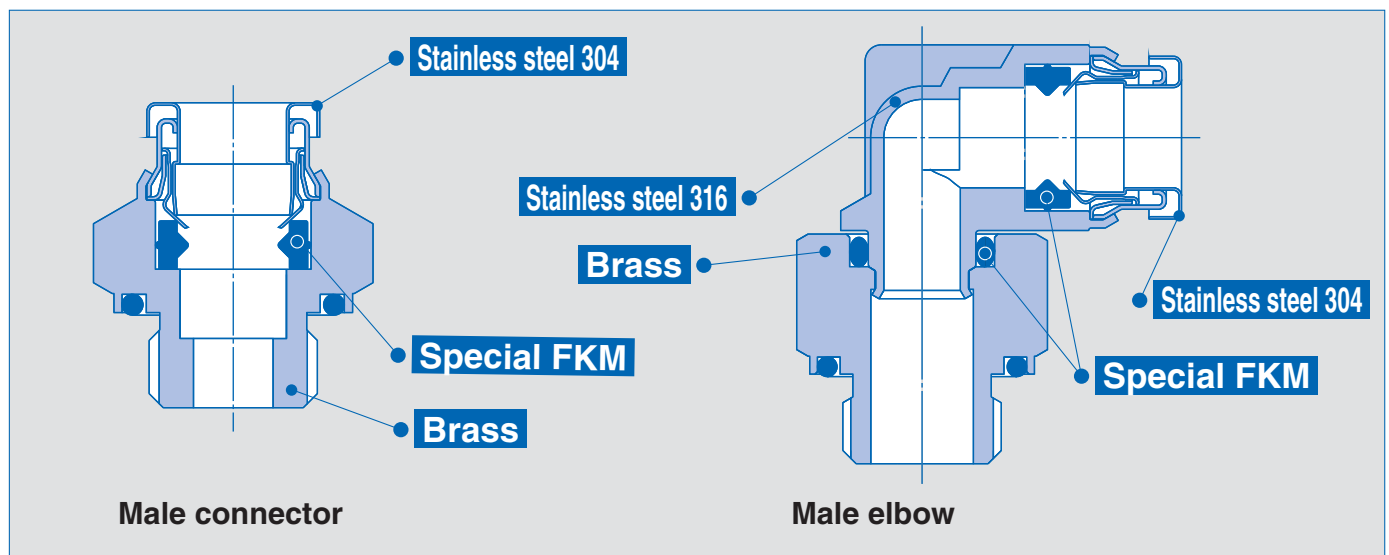

- KQ2
- KQ2-Uni
- KQB2
- KS/KX
- KM
- KF
- M
- H/DL L/LL
- KC
- KK
- KKH
- KK 130
- DM
- DMK
- KDM
- MQR
- KB
- KR-W2
- KRM
- KA
- KQG2
- KG
- KFG2
- MS
- KKA
- KP
- KPQ/KPG
- LQ1
- LQ3
- LQHB

Male connector

KQB2H

Applicable tubing O.D. [mm]	Connection thread R, M	Model
Ø 3.2	M5 x 0.8	KQB2H23-M5
	R 1/8	KQB2H23-01S
	R 1/4	KQB2H23-02S
Ø 4	M5 x 0.8	KQB2H04-M5
	R 1/8	KQB2H04-01S
	R 1/4	KQB2H04-02S
Ø 6	M5 x 0.8	KQB2H06-M5
	R 1/8	KQB2H06-01S
	R 1/4	KQB2H06-02S
	R 3/8	KQB2H06-03S
Ø 8	R 1/8	KQB2H08-01S
	R 1/4	KQB2H08-02S
	R 3/8	KQB2H08-03S
Ø 10	R 1/8	KQB2H10-01S
	R 1/4	KQB2H10-02S
	R 3/8	KQB2H10-03S
Ø 12	R 1/4	KQB2H12-02S
	R 3/8	KQB2H12-03S
Ø 16	R 3/8	KQB2H16-03S
	R 1/2	KQB2H16-04S



Straight union

KQB2H

Applicable tubing O.D. [mm]	Model
Ø 3.2	KQB2H23-00
Ø 4	KQB2H04-00
Ø 6	KQB2H06-00
Ø 8	KQB2H08-00
Ø 10	KQB2H10-00
Ø 12	KQB2H12-00
Ø 16	KQB2H16-00



Male elbow

KQB2L

Applicable tubing O.D. [mm]	Connection thread	Model
Ø 3.2	M5 x 0.8	KQB2L23-M5
	R 1/8	KQB2L23-01S
	R 1/4	KQB2L23-02S
Ø 4	M5 x 0.8	KQB2L04-M5
	R 1/8	KQB2L04-01S
	R 1/4	KQB2L04-02S
Ø 6	M5 x 0.8	KQB2L06-M5
	R 1/8	KQB2L06-01S
	R 1/4	KQB2L06-02S
	R 3/8	KQB2L06-03S
Ø 8	R 1/8	KQB2L08-01S
	R 1/4	KQB2L08-02S
	R 3/8	KQB2L08-03S
Ø 10	R 1/8	KQB2L10-01S
	R 1/4	KQB2L10-02S
	R 3/8	KQB2L10-03S
Ø 12	R 1/4	KQB2L12-02S
	R 3/8	KQB2L12-03S
	R 1/2	KQB2L12-04S
Ø 16	R 3/8	KQB2L16-03S
	R 1/2	KQB2L16-04S



Hexagon socket head male connector

KQB2S

Applicable tubing O.D. [mm]	Connection thread	Model
Ø 3.2	M5 x 0.8	KQB2S23-M5
Ø 4	M5 x 0.8	KQB2S04-M5
	R 1/8	KQB2S04-01S
Ø 6	M5 x 0.8	KQB2S06-M5
	R 1/8	KQB2S06-01S
	R 1/4	KQB2S06-02S
Ø 8	R 1/8	KQB2S08-01S
	R 1/4	KQB2S08-02S
	R 3/8	KQB2S08-03S
Ø 10	R 1/8	KQB2S10-01S
	R 1/4	KQB2S10-02S
	R 3/8	KQB2S10-03S
	R 1/2	KQB2S10-04S
Ø 12	R 1/4	KQB2S12-02S
	R 3/8	KQB2S12-03S
	R 1/2	KQB2S12-04S
Ø 16	R 3/8	KQB2S16-03S
	R 1/2	KQB2S16-04S



Note) For dimensions and other details refer to specific catalogue of the series at www.smc.eu

Male branch tee
KQB2T

Applicable tubing O.D. [mm]	Connection thread	Model
Ø 3.2	M5 x 0.8	KQB2T23-M5
	R 1/8	KQB2T23-01S
	R 1/4	KQB2T23-02S
Ø 4	M5 x 0.8	KQB2T04-M5
	R 1/8	KQB2T04-01S
	R 1/4	KQB2T04-02S
Ø 6	M5 x 0.8	KQB2T06-M5
	R 1/8	KQB2T06-01S
	R 1/4	KQB2T06-02S
	R 3/8	KQB2T06-03S
Ø 8	R 1/8	KQB2T08-01S
	R 1/4	KQB2T08-02S
	R 3/8	KQB2T08-03S
Ø 10	R 1/8	KQB2T10-01S
	R 1/4	KQB2T10-02S
	R 3/8	KQB2T10-03S
Ø 12	R 1/2	KQB2T10-04S
	R 1/4	KQB2T12-02S
	R 3/8	KQB2T12-03S
Ø 16	R 1/2	KQB2T12-04S
	R 3/8	KQB2T16-03S
	R 1/2	KQB2T16-04S

Union tee
KQB2T



Applicable tubing O.D. [mm]	Model
Ø 3.2	KQB2T23-00
Ø 4	KQB2T04-00
Ø 6	KQB2T06-00
Ø 8	KQB2T08-00
Ø 10	KQB2T10-00
Ø 12	KQB2T12-00
Ø 16	KQB2T16-00

Union "Y"
KQB2U

Applicable tubing O.D. [mm]	Model
Ø 3.2	KQB2U23-00
Ø 4	KQB2U04-00
Ø 6	KQB2U06-00
Ø 8	KQB2U08-00
Ø 10	KQB2U10-00
Ø 12	KQB2U12-00
Ø 16	KQB2U16-00

Union elbow
KQB2L

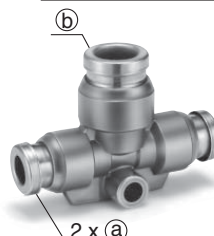
Applicable tubing O.D. [mm]	Model
Ø 3.2	KQB2L23-00
Ø 4	KQB2L04-00
Ø 6	KQB2L06-00
Ø 8	KQB2L08-00
Ø 10	KQB2L10-00
Ø 12	KQB2L12-00
Ø 16	KQB2L16-00

Different diameter tee
KQB2T

Applicable tubing O.D. [mm]		Model
(a)	(b)	
Ø 3.2	Ø 4	KQB2T23-04
Ø 4	Ø 6	KQB2T04-06
Ø 6	Ø 8	KQB2T06-08
Ø 8	Ø 10	KQB2T08-10
Ø 10	Ø 12	KQB2T10-12
Ø 12	Ø 16	KQB2T12-16

Bulkhead Union
KQB2E

Applicable tubing O.D. [mm]	Model
Ø 3.2	KQB2E23-00
Ø 4	KQB2E04-00
Ø 6	KQB2E06-00
Ø 8	KQB2E08-00
Ø 10	KQB2E10-00
Ø 12	KQB2E12-00
Ø 16	KQB2E16-00

Plug-in reducer
KQB2R



Applicable tubing O.D. [mm]	Applicable fitting size Ød	Model
Ø 3.2	Ø 4	KQB2R23-04
Ø 4	Ø 6	KQB2R04-06
Ø 6	Ø 8	KQB2R06-08
Ø 8	Ø 10	KQB2R08-10
Ø 10	Ø 12	KQB2R10-12
Ø 12	Ø 16	KQB2R12-16

Note) For dimensions and other details refer to specific catalogue of the series at www.smc.eu

- KQ2
- KQ2-Uni
- KQB2
- KS/KX
- KM
- KF
- M
- H/DL L/L
- KC
- KK
- KKH
- KK 130
- DM
- DMK
- KDM
- MQR
- KB
- KR-W2
- KRM
- KA
- KQG2
- KG
- KFG2
- MS
- KKA
- KP
- KPQ/KPG
- LQ1
- LQ3
- LQHB

Different diameter straight

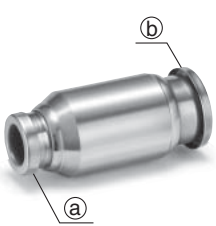
KQB2H



Applicable tubing O.D. [mm]		Model
(a)	(b)	
Ø 3.2	Ø 4	KQB2H23-04
Ø 4	Ø 6	KQB2H04-06
Ø 6	Ø 8	KQB2H06-08
Ø 8	Ø 10	KQB2H08-10
Ø 10	Ø 12	KQB2H10-12
Ø 12	Ø 16	KQB2H12-16

Different diameter union "Y"

KQB2U



Applicable tubing O.D. [mm]		Model
(a)	(b)	
Ø 3.2	Ø 4	KQB2U23-04
Ø 4	Ø 6	KQB2U04-06
Ø 6	Ø 8	KQB2U06-08
Ø 8	Ø 10	KQB2U08-10
Ø 10	Ø 12	KQB2U10-12
Ø 12	Ø 16	KQB2U12-16

Bulkhead connector

KQB2E



Applicable tubing O.D. [mm]	Connection thread	Model
Ø 3.2	Rc 1/4	KQB2E23-02
Ø 4	Rc 1/8	KQB2E04-01
	Rc 1/4	KQB2E04-02
Ø 6	Rc 1/8	KQB2E06-01
	Rc 1/4	KQB2E06-02
	Rc 3/8	KQB2E06-03
Ø 8	Rc 1/8	KQB2E08-01
	Rc 1/4	KQB2E08-02
	Rc 3/8	KQB2E08-03
Ø 10	Rc 1/4	KQB2E10-02
	Rc 3/8	KQB2E10-03
Ø 12	Rc 3/8	KQB2E12-03
	Rc 1/2	KQB2E12-04
Ø 16	Rc 3/8	KQB2E16-03
	Rc 1/2	KQB2E16-04

Extended male elbow

KQB2W



Applicable tubing O.D. [mm]	Connection thread	Model
Ø 3.2	M5 x 0.8	KQB2W23-M5
	R 1/8	KQB2W23-01S
	R 1/4	KQB2W23-02S
Ø 4	M5 x 0.8	KQB2W04-M5
	R 1/8	KQB2W04-01S
	R 1/4	KQB2W04-02S
Ø 6	M5 x 0.8	KQB2W06-M5
	R 1/8	KQB2W06-01S
	R 1/4	KQB2W06-02S
	R 3/8	KQB2W06-03S
Ø 8	R 1/8	KQB2W08-01S
	R 1/4	KQB2W08-02S
	R 3/8	KQB2W08-03S
Ø 10	R 1/4	KQB2W10-02S
	R 3/8	KQB2W10-03S
Ø 12	R 1/2	KQB2W10-04S
	R 1/4	KQB2W12-02S
Ø 12	R 3/8	KQB2W12-03S
	R 1/2	KQB2W12-04S
Ø 16	R 3/8	KQB2W16-03S
	R 1/2	KQB2W16-04S

Female connector

KQB2F



Applicable tubing O.D. [mm]	Connection thread	Model
Ø 3.2	Rc 1/8	KQB2F23-01
Ø 4	Rc 1/8	KQB2F04-01
	Rc 1/4	KQB2F04-02
Ø 6	Rc 1/8	KQB2F06-01
	Rc 1/4	KQB2F06-02
	Rc 3/8	KQB2F06-03
Ø 8	Rc 1/8	KQB2F08-01
	Rc 1/4	KQB2F08-02
	Rc 3/8	KQB2F08-03
Ø 10	Rc 1/4	KQB2F10-02
	Rc 3/8	KQB2F10-03
Ø 12	Rc 1/4	KQB2F12-02
	Rc 3/8	KQB2F12-03
Ø 12	Rc 1/2	KQB2F12-04
	Rc 3/8	KQB2F16-03
Ø 16	Rc 1/2	KQB2F16-04

Note) For dimensions and other details refer to specific catalogue of the series at www.smc.eu

Plug **KQB2P**

	Applicable fitting size Ø d	Model
	Ø 3.2	KQB2P-23
	Ø 4	KQB2P-04
	Ø 6	KQB2P-06
	Ø 8	KQB2P-08
	Ø 10	KQB2P-10
	Ø 12	KQB2P-12
	Ø 16	KQB2P-16

Spare Parts

Description	Tubing O.D.	Part no.	Material
Gasket	—	M-5G3	Stainless steel 316, Special FKM
Bulkhead nut	Ø 3.2	KQB223-P01	C3604 (Electroless nickel plated)
	Ø 4		
	Ø 6	KQB206-P01	
	Ø 8	KQB208-P01	
	Ø 10	KQB210-P01	
	Ø 12	KQB212-P01	
	Ø 16	KQB216-P01	

Note) For dimensions and other details refer to specific catalogue of the series at www.smc.eu

KQ2

KQ2-
Uni

KQB2

KS/
KX

KM

KF

M

H/DL
L/LL

KC

KK

KKH

KK
130

DM

DMK

KDM

MQR

KB

KR
-W2

KRM

KA

KQG2

KG

KFG2

MS

KKA

KP

KPQ/
KPG

LQ1

LQ3

LQHB

Metal One-touch Fittings

RoHS

KQB2 Series

■ Applicable tubing O.D. : Metric Size

■ Connection thread : G

Fluid temperature: -5 to 150 °C

Grease-free

Applicable tubing material:

- FEP • PFA • Nylon
- Soft nylon
- Polyurethane
- Polyolefin

Electroless nickel plated
(Brass parts)



Heat Resistant

Spatter Proof

Applicable Tubing

Tubing material	FEP, PFA, Nylon, Soft nylon ^{Note 1)} , Polyurethane, Polyolefin
Tubing O.D.	Ø 4, Ø 6, Ø 8, Ø 10, Ø 12, Ø 16

Specifications

Fluid	Air/Water
Operating pressure range ^{Note 2)}	-100 kPa to 1 MPa ^{Note 3)}
Proof pressure	3.0 MPa
Ambient and fluid temperature ^{Note 4)}	-5 to 150 °C (No freezing) ^{Note 3)}
Lubricant	Grease-free specification
Seal on the threads	With sealant

Note 1) For soft nylon tubing, water cannot be used.

Note 2) Avoid using in a vacuum holding application such as a leak tester, since there is leakage.

Note 3) Check the operating pressure range and operating temperature range of the tubing.

Note 4) It is recommended that you use the inner sleeve in the following conditions.

- When using in an environment where the fluid temperature changes drastically.
- When using at a high temperature.

*Temperature Condition of Mounting the Inner Sleeve

Tubing	Temperature
FEP tubing/Series TH	80 °C or more
Super PFA tubing/Series TL	120 °C or more

Spare parts

Description	Tube O.D.	Part no.	Material
Bulkhead nut	Ø 4	KQB223-P01	C3604 (Electroless nickel plated)
	Ø 6	KQB206-P01	
	Ø 8	KQB208-P01	
	Ø 10	KQB210-P01	
	Ø 12	KQB212-P01	
	Ø 16	KQB216-P01	

Description	Thread size	Part no.	Material
G Thread O-ring	G 1/8	KQB2-G01	Special FKM (Fluoro coated)
	G 1/4	KQB2-G02	
	G 3/8	KQB2-G03	
	G 1/2	KQB2-G04	

Cross Reference Table of the Inner Sleeve

Tubing O.D.	Tubing material			Applicable inner sleeve	
	TUS (Soft polyurethane)	TH/TH (FEP)	TL/TIL (PFA)	Part no.	Length [mm]
Ø 4	—	TH0402	—	TJ-0402	18
	TUS0425	TH0425	—	TJ-0425	18
Ø 6	—	—	TL0403	TJ-0403	18
	TUS0604	TH0604	TL0604	TJ-0604	19
Ø 8	TUS0805	—	—	TJ-0805	20.5
	—	TH0806	TL0806	TJ-0806	20.5
Ø 10	TUS1065	—	—	TJ-1065	23
	—	TH1075	—	TJ-1075	23
Ø 12	—	TH1008	TL1008	TJ-1008	23
	TUS1208	—	—	TJ-1208	24
Ø 12	—	TH1209	—	TJ-1209	24
	—	TH1210	TL1210	TJ-1210	24

* C2700 + Electroless nickel plated is used for the TJ series.

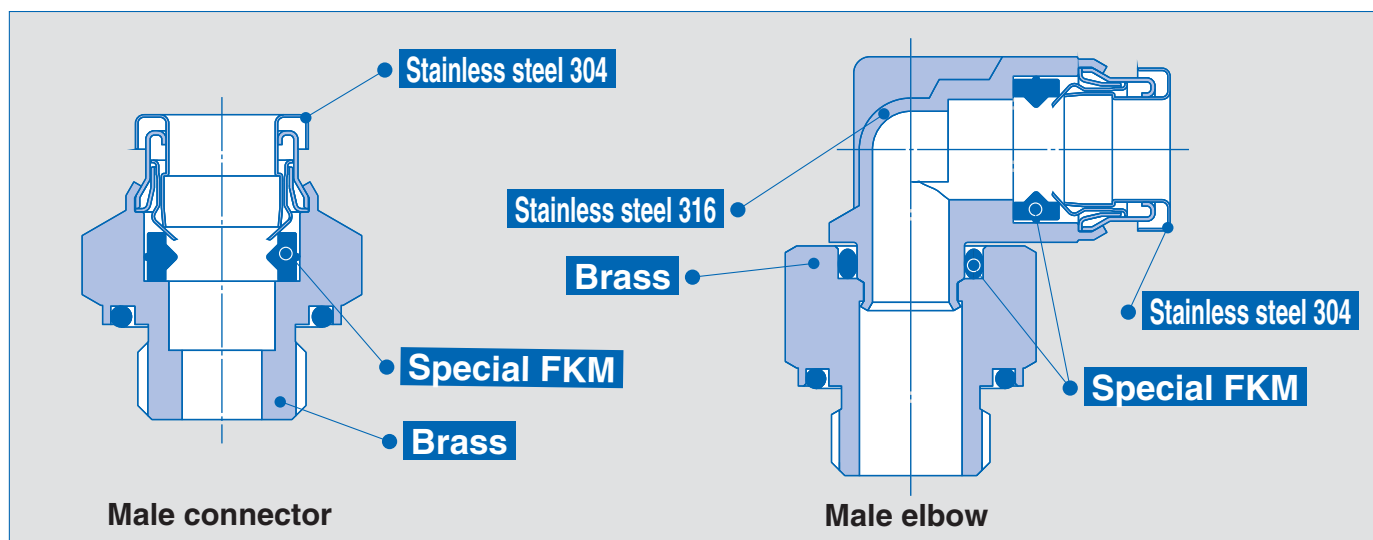

Male connector

KQB2H

	Applicable tubing O.D. [mm]	Connection thread G	Model
	Ø 4	G 1/8	KQB2H04-G01
		G 1/4	KQB2H04-G02
Ø 6	Ø 6	G 1/8	KQB2H06-G01
		G 1/4	KQB2H06-G02
		G 3/8	KQB2H06-G03
Ø 8	Ø 8	G 1/8	KQB2H08-G01
		G 1/4	KQB2H08-G02
		G 3/8	KQB2H08-G03
Ø 10	Ø 10	G 1/8	KQB2H10-G01
		G 1/4	KQB2H10-G02
		G 3/8	KQB2H10-G03
		G 1/2	KQB2H10-G04
Ø 12	Ø 12	G 1/4	KQB2H12-G02
		G 3/8	KQB2H12-G03
		G 1/2	KQB2H12-G04
Ø 16	Ø 16	G 3/8	KQB2H16-G03
		G 1/2	KQB2H16-G04

Male elbow

KQB2L

	Applicable tubing O.D. [mm]	Connection thread G	Model
	Ø 4	G 1/8	KQB2L04-G01
		G 1/4	KQB2L04-G02
Ø 6	Ø 6	G 1/8	KQB2L06-G01
		G 1/4	KQB2L06-G02
		G 3/8	KQB2L06-G03
Ø 8	Ø 8	G 1/8	KQB2L08-G01
		G 1/4	KQB2L08-G02
		G 3/8	KQB2L08-G03
Ø 10	Ø 10	G 1/8	KQB2L10-G01
		G 1/4	KQB2L10-G02
		G 3/8	KQB2L10-G03
		G 1/2	KQB2L10-G04
Ø 12	Ø 12	G 1/4	KQB2L12-G02
		G 3/8	KQB2L12-G03
		G 1/2	KQB2L12-G04
Ø 16	Ø 16	G 3/8	KQB2L16-G03
		G 1/2	KQB2L16-G04

Hexagon socket head male connector

KQB2S

	Applicable tubing O.D. [mm]	Connection thread G	Model
	Ø 4	G 1/8	KQB2S04-G01
		G 1/4	KQB2S04-G02
Ø 6	Ø 6	G 1/8	KQB2S06-G01
		G 1/4	KQB2S06-G02
Ø 8	Ø 8	G 1/8	KQB2S08-G01
		G 1/4	KQB2S08-G02
		G 3/8	KQB2S08-G03
Ø 10	Ø 10	G 1/8	KQB2S10-G01
		G 1/4	KQB2S10-G02
		G 3/8	KQB2S10-G03
		G 1/2	KQB2S10-G04
Ø 12	Ø 12	G 1/4	KQB2S12-G02
		G 3/8	KQB2S12-G03
		G 1/2	KQB2S12-G04
Ø 16	Ø 16	G 3/8	KQB2S16-G03
		G 1/2	KQB2S16-G04

Male branch tee

KQB2T

	Applicable tubing O.D. [mm]	Connection thread G	Model
	Ø 4	G 1/8	KQB2T04-G01
		G 1/4	KQB2T04-G02
Ø 6	Ø 6	G 1/8	KQB2T06-G01
		G 1/4	KQB2T06-G02
		G 3/8	KQB2T06-G03
Ø 8	Ø 8	G 1/8	KQB2T08-G01
		G 1/4	KQB2T08-G02
		G 3/8	KQB2T08-G03
Ø 10	Ø 10	G 1/8	KQB2T10-G01
		G 1/4	KQB2T10-G02
		G 3/8	KQB2T10-G03
		G 1/2	KQB2T10-G04
Ø 12	Ø 12	G 1/4	KQB2T12-G02
		G 3/8	KQB2T12-G03
		G 1/2	KQB2T12-G04
Ø 16	Ø 16	G 3/8	KQB2T16-G03
		G 1/2	KQB2T16-G04

Note) For dimensions and other details refer to specific catalogue of the series at www.smc.eu

- KQ2
- KQ2-Uni
- KQB2
- KS/KX
- KM
- KF
- M
- H/DL L/LL
- KC
- KK
- KKH
- KK 130
- DM
- DMK
- KDM
- MQR
- KB
- KR-W2
- KRM
- KA
- KQG2
- KG
- KFG2
- MS
- KKA
- KP
- KPQ/KPG
- LQ1
- LQ3
- LQHB

Bulkhead connector

KQB2E



Applicable tubing O.D. [mm]	Connection thread G	Model
Ø 4	G 1/8	KQB2E04-G01
	G 1/4	KQB2E04-G02
Ø 6	G 1/8	KQB2E06-G01
	G 1/4	KQB2E06-G02
	G 3/8	KQB2E06-G03
Ø 8	G 1/8	KQB2E08-G01
	G 1/4	KQB2E08-G02
	G 3/8	KQB2E08-G03
Ø 10	G 1/4	KQB2E10-G02
	G 3/8	KQB2E10-G03
Ø 12	G 3/8	KQB2E12-G03
	G 1/2	KQB2E12-G04
Ø 16	G 3/8	KQB2E16-G03
	G 1/2	KQB2E16-G04

Female connector

KQB2F



Applicable tubing O.D. [mm]	Connection thread G	Model
Ø 4	G 1/8	KQB2F04-G01
	G 1/4	KQB2F04-G02
Ø 6	G 1/8	KQB2F06-G01
	G 1/4	KQB2F06-G02
	G 3/8	KQB2F06-G03
Ø 8	G 1/8	KQB2F08-G01
	G 1/4	KQB2F08-G02
	G 3/8	KQB2F08-G03
Ø 10	G 1/4	KQB2F10-G02
	G 3/8	KQB2F10-G03
Ø 12	G 1/4	KQB2F12-G02
	G 3/8	KQB2F12-G03
Ø 16	G 1/2	KQB2F12-G04
	G 3/8	KQB2F16-G03
Ø 16	G 3/8	KQB2F16-G03
	G 1/2	KQB2F16-G04

Extended male union

KQB2W



Applicable tubing O.D. [mm]	Connection thread G	Model
Ø 4	G 1/8	KQB2W04-G01
	G 1/4	KQB2W04-G02
Ø 6	G 1/8	KQB2W06-G01
	G 1/4	KQB2W06-G02
	G 3/8	KQB2W06-G03
Ø 8	G 1/8	KQB2W08-G01
	G 1/4	KQB2W08-G02
	G 3/8	KQB2W08-G03
Ø 10	G 1/4	KQB2W10-G02
	G 3/8	KQB2W10-G03
	G 1/2	KQB2W10-G04
Ø 12	G 1/4	KQB2W12-G02
	G 3/8	KQB2W12-G03
	G 1/2	KQB2W12-G04
Ø 16	G 3/8	KQB2W16-G03
	G 1/2	KQB2W16-G04

Note) For dimensions and other details refer to specific catalogue of the series at www.smc.eu

Rotary One-touch Fittings

RoHS

Fittings

KS/KX Series

■ Applicable tubing O.D. : Metric Size

■ Connection thread : M, R

Low torque rotation style rotary One-touch fittings

Applicable to use for oscillating and rotating sections in robots.
Copper-free specifications (With electroless nickel plated).
Sealant is standard.



Male elbow

Male connector

Applicable Tubing

Tubing material ^{Note 1)}	FEP, PFA, Nylon, Soft nylon, Polyurethane
Tubing O.D.	Ø 4, Ø 6, Ø 8, Ø 10, Ø 12

Note 1) Use caution at the max. operating pressure when using soft nylon or polyurethane tubing.

Specifications

Fluid	Air
Operating pressure range ^{Note 2)}	-100 kPa to 1 MPa
Proof pressure	3 MPa
Ambient and fluid temperature	-5 to 60 °C (No freezing)
Thread	JIS B0203 (Taper thread for piping) JIS B0205 (Metric coarse thread)

Note 2) Please avoid using in a vacuum holding application such as a leak tester, since there is leakage. Also, when using in a vacuum, grease may enter the inside due to the nature of its construction.

Rotating Torque/Allowable Number of Rotations

Applicable tubing O.D.	Ø 4	Ø 6	Ø 8	Ø 10	Ø 12	
Rotating torque [N·m] ^{Note 3)}	0.006	0.012	0.014	0.020	0.022	
Allowable number of rotations s ⁻¹ ^{Note 4)}	Series KS	8.4	8.4	6.7	5	4.2
	Series KX	25	20	20	16.7	16.7

Note 3) Rotating torque under pressure 0.5 MPa

Note 4) Number of rotations per second

Slide bearing

Smooth operation and longer life from an oil containing slide bearing.

Rotary seal

A special rotary seal minimises friction while providing an excellent seal.

Holder

Standard nickel plated allows copper-free applications.

Ball bearing

A ball bearing ensures low torque rotation.

Stud

Electroless nickel plated
With thread sealant (R thread only)

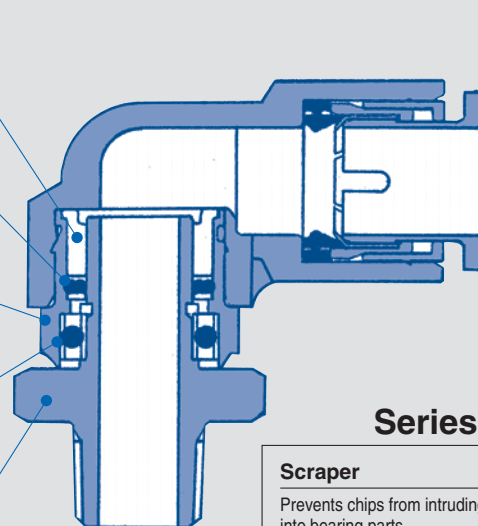

Series KS (Standard)

Cassette

Series KS: Blue
Series KX: Light grey
The male connector is equipped with a "tube rotation prevention mechanism".

Series KX (High speed)

Scraper

Prevents chips from intruding into bearing parts.

Rotary seal

X ring shape minimises friction while providing an excellent seal. Seal is fire and shock proof fluorine rubber. Proves against high friction heat in high speed rotation and longer life.

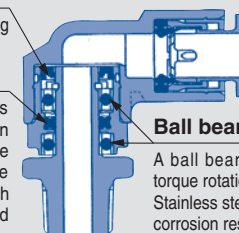

Ball bearing

A ball bearing ensures low torque rotation. Stainless steel 440C improves corrosion resistance.

* Other parts' specifications are same as those of Series KS.

Note) For inch size, refer to the **WEB catalog** at www.smc.eu. (Inch size is not available for the KX series.)

KQ2

KQ2-
Uni

KQB2

KS/
KX

KM

KF

M

H/DL
L/LL

KC

KK

KKH

KK
130

DM

DMK

KDM

MQR

KB

KR
-W2

KRM

KA

KQG2

KG

KFG2

MS

KKA

KP

KPQ/
KPG

LQ1

LQ3

LQHB

Standard Type

Rotary One-touch Fittings

KS Series

Male connector

KSH

Use to pipe a female thread.
Most general model.

Applicable tubing O.D. [mm]	Connection thread	Model
Ø 4	M5 x 0.8	KSH04-M5
	M6 x 1.0	KSH04-M6
	R 1/8	KSH04-01S
Ø 6	M5 x 0.8	KSH06-M5
	M6 x 1.0	KSH06-M6
	R 1/8	KSH06-01S
	R 1/4	KSH06-02S
Ø 8	R 1/8	KSH08-01S
	R 1/4	KSH08-02S
	R 3/8	KSH08-03S
Ø 10	R 1/4	KSH10-02S
	R 3/8	KSH10-03S
	R 1/2	KSH10-04S
Ø 12	R 3/8	KSH12-03S
	R 1/2	KSH12-04S



<M5, M6>



<R>

Male elbow

KSL

Use to pipe a female thread at right angles.
Most general model.

Applicable tubing O.D. [mm]	Connection thread	Model
Ø 4	M5 x 0.8	KSL04-M5
	M6 x 1.0	KSL04-M6
	R 1/8	KSL04-01S
Ø 6	M5 x 0.8	KSL06-M5
	M6 x 1.0	KSL06-M6
	R 1/8	KSL06-01S
	R 1/4	KSL06-02S
Ø 8	R 1/8	KSL08-01S
	R 1/4	KSL08-02S
	R 3/8	KSL08-03S
Ø 10	R 1/4	KSL10-02S
	R 3/8	KSL10-03S
	R 1/2	KSL10-04S
Ø 12	R 3/8	KSL12-03S
	R 1/2	KSL12-04S



<M5, M6>



<R>

High Speed Type

Rotary One-touch Fittings

KX Series

Male connector

KXH

Use to pipe a female thread.
Most general model.

Applicable tubing O.D. [mm]	Connection thread	Model
Ø 4	M5 x 0.8	KXH04-M5
	M6 x 1.0	KXH04-M6
	R 1/8	KXH04-01S
Ø 6	M5 x 0.8	KXH06-M5
	M6 x 1.0	KXH06-M6
	R 1/8	KXH06-01S
	R 1/4	KXH06-02S
Ø 8	R 1/8	KXH08-01S
	R 1/4	KXH08-02S
	R 3/8	KXH08-03S
Ø 10	R 1/4	KXH10-02S
	R 3/8	KXH10-03S
	R 1/2	KXH10-04S
Ø 12	R 3/8	KXH12-03S
	R 1/2	KXH12-04S



<M5, M6>



<R>

Male elbow

KXL

Use to pipe a female thread at right angles.
Most general model.

Applicable tubing O.D. [mm]	Connection thread	Model
Ø 4	M5 x 0.8	KXL04-M5
	M6 x 1.0	KXL04-M6
	R 1/8	KXL04-01S
Ø 6	M5 x 0.8	KXL06-M5
	M6 x 1.0	KXL06-M6
	R 1/8	KXL06-01S
	R 1/4	KXL06-02S
Ø 8	R 1/8	KXL08-01S
	R 1/4	KXL08-02S
	R 3/8	KXL08-03S
Ø 10	R 1/4	KXL10-02S
	R 3/8	KXL10-03S
	R 1/2	KXL10-04S
Ø 12	R 3/8	KXL12-03S
	R 1/2	KXL12-04S



<M5, M6>



<R>

Note) For dimensions and other details refer to specific catalogue of the series at www.smc.eu

One-touch Fittings Manifold

RoHS

KM Series

■ Applicable tubing O.D. : Metric Size

■ Connection thread : R, Rc

Compact piping possible.
Manifold piping possible.
Many varieties (40 types) are available.
One-touch fittings give the most efficient operation.

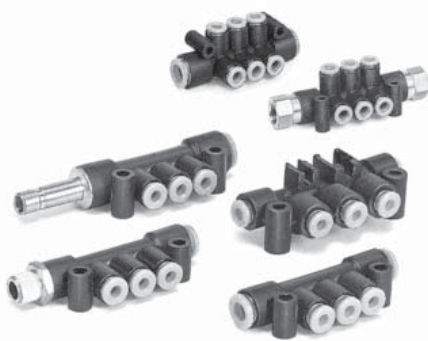

Applicable Tubing

Tubing material	FEP, PFA, Nylon, Soft nylon, Polyurethane
Tubing O.D.	Ø 4, Ø 6, Ø 8, Ø 10, Ø 12

Specifications

Model	KM11	KM12	KM13	KM14	KM15	KM16
Fluid	Air/Water ^{Note 1)}					
Maximum operating pressure	1 MPa					
Proof pressure	3 MPa					
Ambient and fluid temperature	-5 to 60 °C, Water: 0 to 40 °C (No freezing)					
Thread	—	JIS B0203 (Taper thread for piping)	—	JIS B0203 (Taper thread for piping)	—	—
Accessory	None	Hexagon socket head blank plug with seal: 1 pc.	None	None	None	None

Note 1) The surge pressure must be under the maximum operating pressure.

Model

Model	Porting		No. of Port A	Port B size	Port A size		
	Port A	Port B			Ø 4	Ø 6	Ø 8
KM11	One-touch fitting	One-touch fitting	6, 10	Ø 8	●		
				Ø 10		●	
				Ø 12			●
KM12	One-touch fitting	Rc female thread	6, 10	Rc 1/4	●	●	
				Rc 3/8			●
KM13	One-touch fitting	One-touch fitting	3	Ø 6	●		
				Ø 8	●	●	
				Ø 10		●	●
KM14	One-touch fitting	One-touch fitting R male thread	3	Ø 6, R 1/8	●		
				Ø 6, R 1/4	●		
				Ø 6, R 3/8	●		
				Ø 8, R 1/8	●	●	
				Ø 8, R 1/4	●	●	
				Ø 8, R 3/8	●	●	
				Ø 10, R 1/4		●	●
				Ø 10, R 3/8		●	●
KM15	One-touch fitting	One-touch fitting Rod	3	Ø 6	●		
				Ø 8	●	●	
				Ø 10		●	●
KM16	One-touch fitting	One-touch fitting	3	Ø 4	●		
				Ø 6	●	●	

Note) For inch size, refer to the **WEB catalogue** at www.smc.eu

KM11

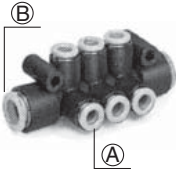

Applicable tubing O.D. [mm]	No. of Port A		Model
	(A)	(B)	
Ø 4	Ø 8	6	KM11-04-08-6
		10	KM11-04-08-10
Ø 6	Ø 10	6	KM11-06-10-6
		10	KM11-06-10-10
Ø 8	Ø 12	6	KM11-08-12-6
		10	KM11-08-12-10

KM12



Applicable tubing O.D. (A) [mm]	Connection thread	No. of Port A	Model
Ø 4	Rc 1/4	6	KM12-04-02-6
		10	KM12-04-02-10
Ø 6	Rc 1/4	6	KM12-06-02-6
		10	KM12-06-02-10
Ø 8	Rc 3/8	6	KM12-08-03-6
		10	KM12-08-03-10

KM13



Applicable tubing O.D. [mm]		No. of Port A	Model
(A)	(B)		
Ø 4	Ø 6	3	KM13-04-06-3
	Ø 8	3	KM13-04-08-3
Ø 6	Ø 8	3	KM13-06-08-3
	Ø 10	3	KM13-06-10-3
Ø 8	Ø 10	3	KM13-08-10-3

Note) For dimensions and other details refer to specific catalogue of the series at www.smc.eu

KM14

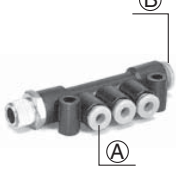

Applicable tubing O.D. [mm]		Connection thread	No. of Port A	Model
(A)	(B)			
Ø 4	Ø 6	R 1/8	3	KM14-04-06-01S-3
		R 1/4	3	KM14-04-06-02S-3
		R 3/8	3	KM14-04-06-03S-3
Ø 4	Ø 8	R 1/8	3	KM14-04-08-01S-3
		R 1/4	3	KM14-04-08-02S-3
		R 3/8	3	KM14-04-08-03S-3
Ø 6	Ø 8	R 1/8	3	KM14-06-08-01S-3
		R 1/4	3	KM14-06-08-02S-3
		R 3/8	3	KM14-06-08-03S-3
Ø 6	Ø 10	R 1/4	3	KM14-06-10-02S-3
		R 3/8	3	KM14-06-10-03S-3
		R 1/2	3	KM14-06-10-04S-3
Ø 8	Ø 10	R 1/4	3	KM14-08-10-02S-3
		R 3/8	3	KM14-08-10-03S-3
		R 1/2	3	KM14-08-10-04S-3

KM15

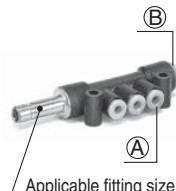

Applicable tubing O.D. [mm]		Applicable fitting size	No. of Port A	Model
(A)	(B)			
Ø 4	Ø 6	Ø 6	3	KM15-04-06-3
	Ø 8	Ø 8	3	KM15-04-08-3
Ø 6	Ø 8	Ø 8	3	KM15-06-08-3
	Ø 10	Ø 10	3	KM15-06-10-3
Ø 8	Ø 10	Ø 10	3	KM15-08-10-3

KM16

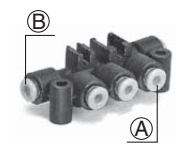

Applicable tubing O.D. [mm]		No. of Port A	Model
(A)	(B)		
Ø 4	Ø 4	3	KM16-04-04-3
Ø 4	Ø 4	3	KM16-04-06-3
Ø 6	Ø 6	3	KM16-06-06-3



Made to Order

1 Grease-free Specifications

Symbol	Specifications
X17	Grease-free Rubber material: NBR (With fluorine coating) Release button colour: Light blue
X29	Grease-free Rubber material: NBR (With fluorine coating) Release button colour: Light blue Copper-free (With electroless nickel plated)
X94	Grease-free Rubber material: FKM (With fluorine coating) Release button colour: Light blue

Suffix “-X17” to the end of part number.
Example) **KM11-04-08-10-X17**

2 Other Specifications

Symbol	Specifications
X2	Copper-free (With electroless nickel plated)
X12	Lubricant: White vaseline Release button colour: White
X34	Rubber material: FKM

Suffix “-X2” to the end of part number.
Example) **KM12-04-02-6-X2**

KQ2

KQ2
-Uni

KQB2

KS/
KX

KM

KF

M

H/DL
L/LL

KC

KK

KKH

KK
130

DM

DMK

KDM

MQR

KB

KR
-W2

KRM

KA

KQG2

KG

KFG2

MS

KKA

KP

KPQ/
KPG

LQ1

LQ3

LQHB

Insert Fittings

RoHS

KF Series

■ Applicable tubing O.D. : **Metric Size**

■ Connection thread : **R**

Heat Resistant
(Brass sleeve)

Spatter Proof
(Brass sleeve)

Material / Body, Union nut: **Brass**
Sleeve: **Resin or Brass**

Maximum operating temperature /
150 °C
(Brass sleeve)
60 °C
(Resin sleeve)

Applicable tubing material:

FEP, PFA, Denatured PTFE, Nylon
Soft nylon, Polyurethane
Polyolefin, Soft polyolefin

Can be used with steam.

(For brass sleeve)

Grease-free

Applicable Tubing

Series	Tubing material	Tubing O.D. x I.D.								
		Ø 4/Ø 2.5	Ø 6/Ø 4	Ø 8/Ø 5	Ø 8/Ø 6	Ø 10/Ø 6.5	Ø 10/Ø 7.5	Ø 12/Ø 8	Ø 12/Ø 9	
T	Nylon	●	●	—	●	—	●	—	●	
TS	Soft nylon	●	●	—	●	—	●	—	●	
TU	Polyurethane	●	●	●	—	●	—	●	—	
TPH	Polyolefin	●	●	—	●	—	●	—	●	
TPS	Soft polyolefin	●	●	●	—	●	—	●	—	
TH	FEP	●	●	—	●	—	●	—	●	
TL	Super PFA	—	●	—	●	—	—	—	—	
TD	Denatured PTFE	●	●	—	●	—	●	—	●	

Specifications

Sleeve material	Nylon	Brass
Fluid	Air/Water ^{Note 2)}	Air/Steam ^{Note 2)}
Ambient and fluid temperature	-5 to 60 °C (No freezing) Water: 0 to 60 °C (No freezing)	-5 to 150 °C (No freezing)
Operating pressure range ^{Note 1)}	-101.3 kPa to 1 MPa	
Proof pressure	7 MPa (at 60 °C)	
Lubricant	Grease-free	
Seal on the threads	None or with sealant	

Note 1) Do not use the fittings with a leak tester or for vacuum retention because they are not guaranteed for zero leakage.

Note 2) Swivel type is not compatible with water and steam.



Resin sleeve



Brass sleeve

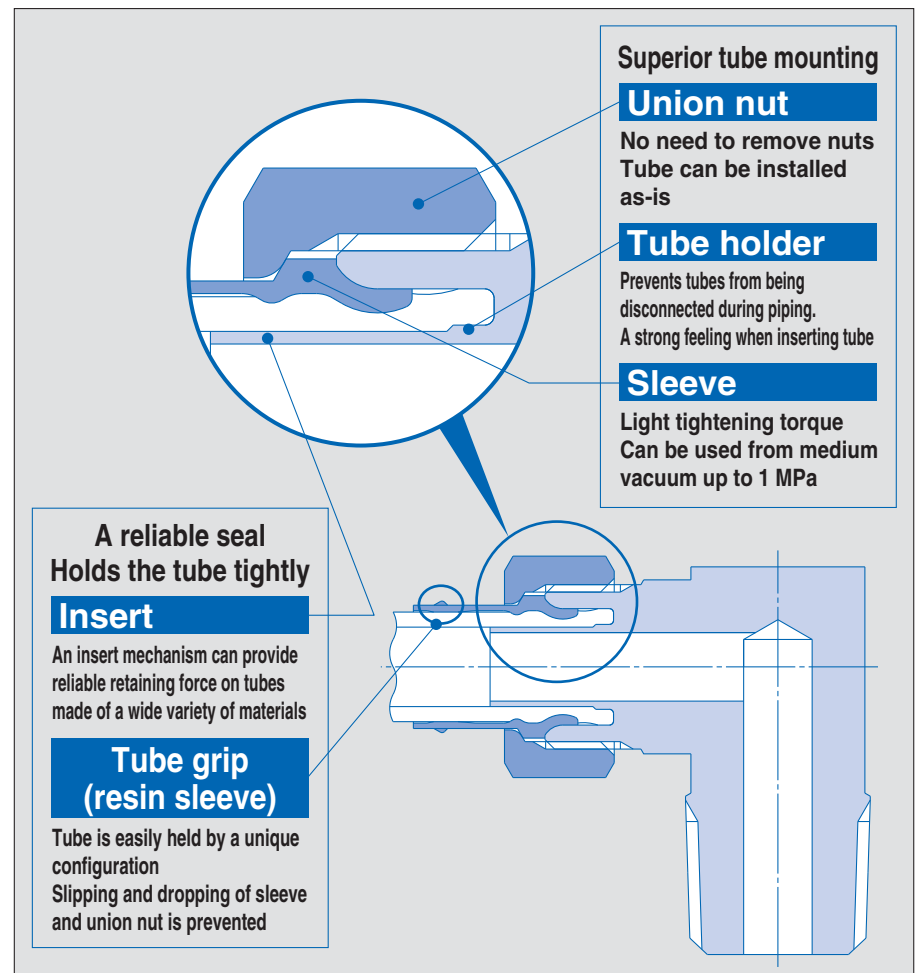





Note) For dimensions and other details refer to specific catalogue of the series at www.smc.eu

Male connector

KFH





Use to connect tubes in the same direction from female thread. Most general type.

	Applicable tubing size [mm]		Connection thread	Model	
	O.D.	I.D.		Resin sleeve	Brass sleeve
 [Resin sleeve]	Ø 4	Ø 2.5	R 1/8	KFH04-01S	KFH04B-01S
			R 1/4	KFH04-02S	KFH04B-02S
 [Resin sleeve]	Ø 6	Ø 4	R 1/8	KFH06-01S	KFH06B-01S
			R 1/4	KFH06-02S	KFH06B-02S
			R 3/8	KFH06-03S	KFH06B-03S
			R 1/2	KFH06-04S	KFH06B-04S
 [Resin sleeve]	Ø 8	Ø 5	R 1/8	KFH08U-01S	—
			R 1/4	KFH08U-02S	—
			R 3/8	KFH08U-03S	—
		Ø 6	R 1/8	KFH08N-01S	KFH08B-01S
			R 1/4	KFH08N-02S	KFH08B-02S
			R 3/8	KFH08N-03S	KFH08B-03S
 [Brass sleeve]	Ø 10	Ø 6.5	R 1/4	KFH10U-02S	—
			R 3/8	KFH10U-03S	—
			R 1/2	KFH10U-04S	—
		Ø 7.5	R 1/4	KFH10N-02S	KFH10B-02S
			R 3/8	KFH10N-03S	KFH10B-03S
			R 1/2	KFH10N-04S	KFH10B-04S
Ø 8	R 1/4	KFH12U-02S	—		
	R 3/8	KFH12U-03S	—		
	R 1/2	KFH12U-04S	—		
Ø 12	Ø 9	R 1/4	KFH12N-02S	KFH12B-02S	
		R 3/8	KFH12N-03S	KFH12B-03S	
	Ø 9	R 3/8	KFH12N-03S	KFH12B-03S	
		R 1/2	KFH12N-04S	KFH12B-04S	

Branch tee

KFT





Use to branch line from female thread in both 90° directions.

	Applicable tubing size [mm]		Connection thread	Model	
	O.D.	I.D.		Resin sleeve	Brass sleeve
 [Resin sleeve]	Ø 4	Ø 2.5	R 1/8	KFT04-01S	KFT04B-01S
			R 1/4	KFT04-02S	KFT04B-02S
 [Resin sleeve]	Ø 6	Ø 4	R 1/8	KFT06-01S	KFT06B-01S
			R 1/4	KFT06-02S	KFT06B-02S
			R 3/8	KFT06-03S	KFT06B-03S
			R 1/2	KFT06-04S	KFT06B-04S
 [Resin sleeve]	Ø 8	Ø 5	R 1/8	KFT08U-01S	—
			R 1/4	KFT08U-02S	—
			R 3/8	KFT08U-03S	—
		Ø 6	R 1/8	KFT08N-01S	KFT08B-01S
			R 1/4	KFT08N-02S	KFT08B-02S
			R 3/8	KFT08N-03S	KFT08B-03S
 [Brass sleeve]	Ø 10	Ø 6.5	R 1/4	KFT10U-02S	—
			R 3/8	KFT10U-03S	—
			R 1/2	KFT10U-04S	—
		Ø 7.5	R 1/4	KFT10N-02S	KFT10B-02S
			R 3/8	KFT10N-03S	KFT10B-03S
			R 1/2	KFT10N-04S	KFT10B-04S
Ø 8	R 1/4	KFT12U-02S	—		
	R 3/8	KFT12U-03S	—		
	R 1/2	KFT12U-04S	—		
Ø 12	Ø 9	R 1/4	KFT12N-02S	KFT12B-02S	
		R 3/8	KFT12N-03S	KFT12B-03S	
	Ø 9	R 3/8	KFT12N-03S	KFT12B-03S	
		R 1/2	KFT12N-04S	KFT12B-04S	

Male elbow

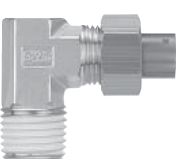
KFL



Use to pipe at right angles to female thread. Most general type.

	Applicable tubing size [mm]		Connection thread	Model	
	O.D.	I.D.		Resin sleeve	Brass sleeve
 [Resin sleeve]	Ø 4	Ø 2.5	R 1/8	KFL04-01S	KFL04B-01S
			R 1/4	KFL04-02S	KFL04B-02S
 [Resin sleeve]	Ø 6	Ø 4	R 1/8	KFL06-01S	KFL06B-01S
			R 1/4	KFL06-02S	KFL06B-02S
			R 3/8	KFL06-03S	KFL06B-03S
			R 1/2	KFL06-04S	KFL06B-04S
 [Resin sleeve]	Ø 8	Ø 5	R 1/8	KFL08U-01S	—
			R 1/4	KFL08U-02S	—
			R 3/8	KFL08U-03S	—
		Ø 6	R 1/8	KFL08N-01S	KFL08B-01S
			R 1/4	KFL08N-02S	KFL08B-02S
			R 3/8	KFL08N-03S	KFL08B-03S
 [Brass sleeve]	Ø 10	Ø 6.5	R 1/4	KFL10U-02S	—
			R 3/8	KFL10U-03S	—
			R 1/2	KFL10U-04S	—
		Ø 7.5	R 1/4	KFL10N-02S	KFL10B-02S
			R 3/8	KFL10N-03S	KFL10B-03S
			R 1/2	KFL10N-04S	KFL10B-04S
Ø 8	R 1/4	KFL12U-02S	—		
	R 3/8	KFL12U-03S	—		
	R 1/2	KFL12U-04S	—		
Ø 12	Ø 9	R 1/4	KFL12N-02S	KFL12B-02S	
		R 3/8	KFL12N-03S	KFL12B-03S	
	Ø 9	R 3/8	KFL12N-03S	KFL12B-03S	
		R 1/2	KFL12N-04S	KFL12B-04S	

Male run tee

KFY

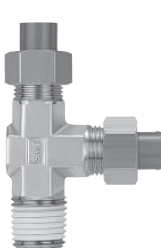
Use to branch line in the same direction from female thread and in 90° direction.

	Applicable tubing size [mm]		Connection thread	Model	
	O.D.	I.D.		Resin sleeve	Brass sleeve
 [Resin sleeve]	Ø 4	Ø 2.5	R 1/8	KFY04-01S	KFY04B-01S
			R 1/4	KFY04-02S	KFY04B-02S
 [Resin sleeve]	Ø 6	Ø 4	R 1/8	KFY06-01S	KFY06B-01S
			R 1/4	KFY06-02S	KFY06B-02S
			R 3/8	KFY06-03S	KFY06B-03S
			R 1/2	KFY06-04S	KFY06B-04S
 [Resin sleeve]	Ø 8	Ø 5	R 1/8	KFY08U-01S	—
			R 1/4	KFY08U-02S	—
			R 3/8	KFY08U-03S	—
		Ø 6	R 1/8	KFY08N-01S	KFY08B-01S
			R 1/4	KFY08N-02S	KFY08B-02S
			R 3/8	KFY08N-03S	KFY08B-03S
 [Brass sleeve]	Ø 10	Ø 6.5	R 1/4	KFY10U-02S	—
			R 3/8	KFY10U-03S	—
			R 1/2	KFY10U-04S	—
		Ø 7.5	R 1/4	KFY10N-02S	KFY10B-02S
			R 3/8	KFY10N-03S	KFY10B-03S
			R 1/2	KFY10N-04S	KFY10B-04S
Ø 8	R 1/4	KFY12U-02S	—		
	R 3/8	KFY12U-03S	—		
	R 1/2	KFY12U-04S	—		
Ø 12	Ø 9	R 1/4	KFY12N-02S	KFY12B-02S	
		R 3/8	KFY12N-03S	KFY12B-03S	
	Ø 9	R 3/8	KFY12N-03S	KFY12B-03S	
		R 1/2	KFY12N-04S	KFY12B-04S	

Swivel elbow

KFV

Use to pipe at right angles to female thread.
Swiveled at any direction.

	Applicable tubing size [mm]		Connection thread	Model	
	O.D.	I.D.		Resin sleeve	Brass sleeve
 [Resin sleeve]	Ø 4	Ø 2.5	R 1/8	KFV04-01S	KFV04B-01S
			R 1/4	KFV04-02S	KFV04B-02S
	Ø 6	Ø 4	R 1/8	KFV06-01S	KFV06B-01S
			R 1/4	KFV06-02S	KFV06B-02S
R 3/8			KFV06-03S	KFV06B-03S	
Ø 8	Ø 5	R 1/8	KFV08U-01S	—	
		R 1/4	KFV08U-02S	—	
		R 3/8	KFV08U-03S	—	
	Ø 6	R 1/8	KFV08N-01S	KFV08B-01S	
		R 1/4	KFV08N-02S	KFV08B-02S	
		R 3/8	KFV08N-03S	KFV08B-03S	
Ø 10	Ø 6.5	R 1/4	KFV10U-02S	—	
		R 3/8	KFV10U-03S	—	
		R 1/2	KFV10U-04S	—	
	Ø 7.5	R 1/4	KFV10N-02S	KFV10B-02S	
		R 3/8	KFV10N-03S	KFV10B-03S	
		R 1/2	KFV10N-04S	KFV10B-04S	
Ø 8	R 1/4	KFV12U-02S	—		
	R 3/8	KFV12U-03S	—		
	R 1/2	KFV12U-04S	—		
Ø 12	Ø 9	R 1/4	KFV12N-02S	KFV12B-02S	
		R 3/8	KFV12N-03S	KFV12B-03S	
		R 1/2	KFV12N-04S	KFV12B-04S	

Straight union

KFH

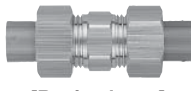
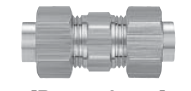

Use to connect tubes in the same direction.

	Applicable tubing size [mm]		Model	
	O.D.	I.D.	Resin sleeve	Brass sleeve
 [Resin sleeve]	Ø 4	Ø 2.5	KFH04-00	KFH04B-00
			Ø 6	Ø 4
 [Brass sleeve]	Ø 8	Ø 5	KFH08U-00	—
		Ø 6	KFH08N-00	KFH08B-00
	Ø 10	Ø 6.5	KFH10U-00	—
		Ø 7.5	KFH10N-00	KFH10B-00
	Ø 12	Ø 8	KFH12U-00	—
		Ø 9	KFH12N-00	KFH12B-00

Tee union

KFT

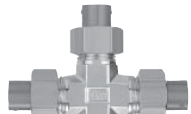
Use to connect tubes in both 90° directions.

	Applicable tubing size [mm]		Model	
	O.D.	I.D.	Resin sleeve	Brass sleeve
 [Resin sleeve]	Ø 4	Ø 2.5	KFT04-00	KFT04B-00
			Ø 6	Ø 4
 [Brass sleeve]	Ø 8	Ø 5	KFT08U-00	—
		Ø 6	KFT08N-00	KFT08B-00
	Ø 10	Ø 6.5	KFT10U-00	—
		Ø 7.5	KFT10N-00	KFT10B-00
Ø 12	Ø 8	KFT12U-00	—	
	Ø 9	KFT12N-00	KFT12B-00	

Swivel long elbow

KFW

Use to pipe at right angles to female thread.
Swiveled at any direction. Solid piece moves fittings up from workpiece.

	Applicable tubing size [mm]		Connection thread	Model	
	O.D.	I.D.		Resin sleeve	Brass sleeve
 [Resin sleeve]	Ø 4	Ø 2.5	R 1/8	KFW04-01S	KFW04B-01S
			R 1/4	KFW04-02S	KFW04B-02S
	Ø 6	Ø 4	R 1/8	KFW06-01S	KFW06B-01S
			R 1/4	KFW06-02S	KFW06B-02S
R 3/8			KFW06-03S	KFW06B-03S	
Ø 8	Ø 5	R 1/8	KFW08U-01S	—	
		R 1/4	KFW08U-02S	—	
		R 3/8	KFW08U-03S	—	
	Ø 6	R 1/8	KFW08N-01S	KFW08B-01S	
		R 1/4	KFW08N-02S	KFW08B-02S	
		R 3/8	KFW08N-03S	KFW08B-03S	
Ø 10	Ø 6.5	R 1/4	KFW10U-02S	—	
		R 3/8	KFW10U-03S	—	
		R 1/2	KFW10U-04S	—	
	Ø 7.5	R 1/4	KFW10N-02S	KFW10B-02S	
		R 3/8	KFW10N-03S	KFW10B-03S	
		R 1/2	KFW10N-04S	KFW10B-04S	
Ø 12	Ø 8	R 1/4	KFW12U-02S	—	
		R 3/8	KFW12U-03S	—	
		R 1/2	KFW12U-04S	—	
Ø 9	Ø 9	R 1/4	KFW12N-02S	KFW12B-02S	
		R 3/8	KFW12N-03S	KFW12B-03S	
		R 1/2	KFW12N-04S	KFW12B-04S	

Bulkhead union

KFE

Use to connect tubes in both 90° directions.

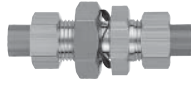
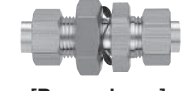
	Applicable tubing size [mm]		Model	
	O.D.	I.D.	Resin sleeve	Brass sleeve
 [Resin sleeve]	Ø 4	Ø 2.5	KFE04-00	KFE04B-00
			Ø 6	Ø 4
 [Brass sleeve]	Ø 8	Ø 5	KFE08U-00	—
		Ø 6	KFE08N-00	KFE08B-00
	Ø 10	Ø 6.5	KFE10U-00	—
		Ø 7.5	KFE10N-00	KFE10B-00
	Ø 12	Ø 8	KFE12U-00	—
		Ø 9	KFE12N-00	KFE12B-00

Note) For dimensions and other details refer to specific catalogue of the series at www.smc.eu

Female union

KFF

Use to pipe from male thread such as pressure gauge.

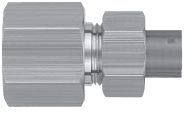
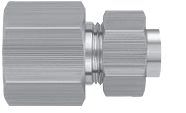
Image	Applicable tubing size [mm]		Connection thread	Model	
	O.D.	I.D.		Resin sleeve	Brass sleeve
	Ø 4	Ø 2.5	Rc 1/4	KFF04-02	KFF04B-02
[Resin sleeve]	Ø 6	Ø 4	Rc 1/4	KFF06-02	KFF06B-02
			Rc 3/8	KFF06-03	KFF06B-03
	Ø 8	Ø 5	Rc 1/4	KFF08U-02	—
			Ø 6	KFF08N-02	KFF08B-02
[Brass sleeve]	Ø 10	Ø 6.5	Rc 1/4	KFF10U-02	—
			Ø 7.5	KFF10N-02	KFF10B-02
	Ø 12	Ø 8	Rc 1/4	KFF12U-02	—
			Ø 9	KFF12N-02	KFF12B-02

Bulkhead connector

KFE

Use to connect male thread and tube through a panel.

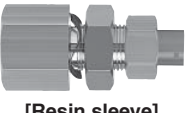
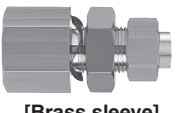
Image	Applicable tubing size [mm]		Connection thread	Model	
	O.D.	I.D.		Resin sleeve	Brass sleeve
	Ø 6	Ø 4	Rc 1/4	KFE06-02	KFE06B-02
[Resin sleeve]	Ø 8	Ø 5	Rc 3/8	KFE08U-03	—
			Ø 6	KFE08N-03	KFE08B-03
	Ø 10	Ø 6.5	Rc 3/8	KFE10U-03	—
			Ø 7.5	KFE10N-03	KFE10B-03
[Brass sleeve]	Ø 12	Ø 8	Rc 3/8	KFE12U-03	—
			Ø 9	KFE12N-03	KFE12B-03

Plug

KFP

Use to plug unused fittings.

Image	Applicable fitting [mm]	Model
	Ø 4	KFP-04
	Ø 6	KFP-06
	Ø 8	KFP-08
	Ø 10	KFP-10
	Ø 12	KFP-12

Note) For dimensions and other details refer to specific catalogue of the series at www.smc.eu



Made to Order

1 Copper-free (With electroless nickel plated)

Symbol	Specifications
X2	Copper-free (With electroless nickel plated)

Suffix “-X2” to the end of part number.
Example) **KFH06-01S-X2**

Elbow connector

KFV

Image	Applicable tubing size [mm]		Model
	O.D.	I.D.	
	Ø 4	Ø 2.5	KFV-04
	Ø 6	Ø 4	KFV-06
		Ø 5	KFV-08U
	Ø 8	Ø 6	KFV-08N
		Ø 6.5	KFV-10U
	Ø 10	Ø 7.5	KFV-10N
		Ø 8	KFV-12U
	Ø 12	Ø 9	KFV-12N



Long elbow connector

KFW

Image	Applicable tubing size [mm]		Model
	O.D.	I.D.	
	Ø 4	Ø 2.5	KFW-04
	Ø 6	Ø 4	KFW-06
		Ø 5	KFW-08U
	Ø 8	Ø 6	KFW-08N
		Ø 6.5	KFW-10U
	Ø 10	Ø 7.5	KFW-10N
		Ø 8	KFW-12U
	Ø 12	Ø 9	KFW-12N

Sleeve

KFS

Image	Applicable fitting [mm]	Model
		Ø 4
Ø 6		KFSB-04
[Resin sleeve]	Ø 6	KFS-06
		KFSB-06
	Ø 8	KFS-08
	Ø 10	KFSB-08
[Brass sleeve]	Ø 10	KFS-10
		KFSB-10
Ø 12	KFS-12	
	KFSB-12	

Union nut

KFN

Image	Applicable fitting [mm]	Model
		Ø 4
Ø 6		KFN-06
Ø 8		KFN-08
Ø 10		KFN-10
Ø 12		KFN-12

M Series

■ Applicable tubing O.D. : Metric Size

■ Connection thread : M3, M5, R 1/8

Compact piping space

Hose nipple tubing connection/disconnection is simple while keeping a large retaining force.

Line up various styles

For air connection in confined areas.

Accepts many styles of plastic tubing

Hose nipple and hose elbow accepts nylon, soft nylon, and polyurethane tubing.

Fittings for $\varnothing 2$ tubing are now available as a series.

Applicable tubing O.D.
: $\varnothing 2$



Applicable tubing O.D.
: $\varnothing 3.18, \varnothing 4, \varnothing 6$



Specifications

• Applicable tubing O.D.: $\varnothing 2$

Tubing material	Polyurethane
Applicable tubing (O.D. / I.D.)	$\varnothing 2 / \varnothing 1.2$
Fluid	Air/Water ^{Note 1)}
Max. operating pressure	1 MPa ^{Note 2)}
Ambient and fluid temperature	-5 to 60 °C, Water: 0 to 40 °C (No freezing)
Port size	M3, M5, $\varnothing 3.2, \varnothing 4$
Thread	JIS B0205 (Metric coarse thread)

Note 1) The surge pressure must be under the maximum operating pressure.

Note 2) Apply the maximum operating pressure to the tube during the tube connection.

• Applicable tubing O.D.: $\varnothing 3.18, \varnothing 4, \varnothing 6$

Applicable tubing material	Nylon	Soft nylon	Polyurethane	Super PFA ^{Note 1)}	FEP ^{Note 2)}	Denatured PTFE ^{Note 3)}
Applicable tubing O.D. / I.D.	M3	—	$\varnothing 3.18 / \varnothing 2.18$	$\varnothing 3.18 / \varnothing 2.5$ $\varnothing 4 / \varnothing 2.5$	—	—
	M5, R 1/8	$\varnothing 4 / \varnothing 2.5$ $\varnothing 6 / \varnothing 4$	$\varnothing 3.18 / \varnothing 2.18$	$\varnothing 3.18 / \varnothing 2.5$ $\varnothing 4 / \varnothing 2.5$ $\varnothing 6 / \varnothing 4$	$\varnothing 6 / \varnothing 4$	$\varnothing 4 / \varnothing 2.5$ $\varnothing 6 / \varnothing 4$ $\varnothing 4 / \varnothing 2.5$ $\varnothing 6 / \varnothing 4$
Fluid	Air/Water ^{Note 4)}					
Max. operating pressure (at 20 °C)	1.5 MPa	1 MPa	0.8 MPa	1 MPa	1.5 MPa	1.4 MPa
Ambient and fluid temperature	-5 to 60 °C, Water: 0 to 40 °C (No freezing)					
Port size	M3, M5, R 1/8			M5, R 1/8		
Thread	JIS B0205 (Metric coarse thread) JIS B0203 (Taper thread for piping)					

Note 1), Note 2), Note 3) Compatible only with hose nipple type.

Note 4) Barb fitting, barb elbow, barb elbow (H) are not compatible with water.

Barb fitting: $\varnothing 2$

Barb
Configuration for easy insertion into the tube
Holds the tube tightly

Body
With electroless nickel plated

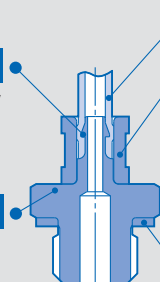

Tube
Sleeve
Attaching the sleeve achieves a large retaining force. Detaching it allows easy removal of the tube.
Electroless nickel plated
Gasket
Low clamping torque
Firm sealing

Barb fitting: $\varnothing 3.18, \varnothing 4, \varnothing 6$

Barb
Configuration for easy insertion into the tube
Holds the tube tightly

Body
With electroless nickel plated

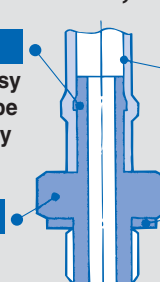

Tube
Gasket
Low clamping torque
Firm sealing

Hose nipple: $\varnothing 3.18, \varnothing 4, \varnothing 6$

Barb
Configuration for easy insertion into the tube Holds the tube tightly

Body
With electroless nickel plated

Gasket
Low clamping torque
Firm sealing

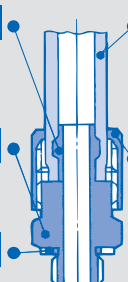

Tube
Applicable for nylon, soft nylon and polyurethane tubing.
Cap nut
Certainly hold the tube by manual clamping
Easy removal of tube by loosening
With electroless nickel plated

Applicable tubing O.D.: $\varnothing 2$
Port size: M3, M5
Barb fitting

Applicable tubing O.D. / I.D. [mm]	Connection thread	Model
$\varnothing 2 \times \varnothing 1.2$	M3 x 0.5	M-3AU-2
	M5 x 0.8	M-5AU-2

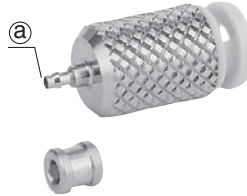
Barb One-touch

Applicable tubing [mm]		Model
(a) (O.D. / I.D.)	(b) (O.D.)	
$\varnothing 2 \times \varnothing 1.2$	$\varnothing 3.2$	M-32F-2
	$\varnothing 4$	M-04F-2

Barb elbow

Applicable tubing O.D. / I.D. [mm]	Connection thread	Model
$\varnothing 2 \times \varnothing 1.2$	M3 x 0.5	M-3ALU-2
	M5 x 0.8	M-5ALHU-2

Plug-in reducer

Applicable tubing O.D. / I.D. [mm]	Fitting size	Model
$\varnothing 2 \times \varnothing 1.2$	$\varnothing 3.2$	M-32R-2
	$\varnothing 4$	M-04R-2

Note) For dimensions and other details refer to specific catalogue of the series at www.smc.eu

Made to Order
1 Gasket Material Modification







Symbol	Specifications	
X226	Gasket material: Stainless steel 304, FKM	
	Applicable thread	Gasket part no.
	M3	M3G-DPH00489
X112	Gasket material: Stainless steel 316, Special FKM	
	Applicable thread	Gasket part no.
	M5	M-5G3

Spare Parts

Description	Part no.	Applicable thread	Material
Gasket	IN-233-706	M3	Stainless steel 304, NBR
	M-5G2	M5	Stainless steel 304, NBR
	M-5G3		Stainless steel 316, Special FKM
Sleeve	M-5-2-P02	—	C3604 (With electroless nickel plated)







Applicable tubing O.D.: \varnothing 3.18, \varnothing 4, \varnothing 6

Port size: M3

Description	Note	Model	Application	
Barb fitting for soft tubing 	\varnothing 3.18/2.18 x M3	M-3AU-3	For soft nylon tubing	
	\varnothing 3.18/2 x M3		For polyurethane tubing	
	\varnothing 4/2.5 x M3	M-3AU-4	For soft nylon and polyurethane tubing	
Barb elbow for soft tubing 	\varnothing 3.18/2.18 x M3	M-3ALU-3	Body rotates at 360° around the stud axis	For soft nylon tubing
	\varnothing 3.18/2 x M3			For polyurethane tubing
	\varnothing 4/2.5 x M3	M-3ALU-4		For soft nylon and polyurethane tubing
Universal elbow 	M3 female x M3 male	M-3UL	Body rotates at 360° around the stud axis	
Universal tee 	M3 female x M3 female x M3 male	M-3UT	Body rotates at 360° around the stud axis	
Nipple 	M3 male x M3 male	M-3N	Fitting to workpiece and fitting to fitting connection	
Plug 		M-3P	Use to plug unused M3 port	
Gasket 		M-3G2	Seal on the M3 threads	











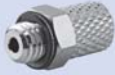

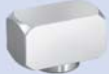
Note) For dimensions and other details refer to specific catalogue of the series at www.smc.eu



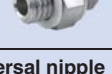

Port size: M5

Description	Note	Model	Application	
Barb fitting for nylon tubing 	\varnothing 4/2.5 x M5	M-5AN-4	For nylon tubing	
	\varnothing 6/4 x M5	M-5AN-6		
Barb fitting for soft tube 	\varnothing 3.18/2.18 x M5	M-5AU-3	For soft nylon tubing	
	\varnothing 3.18/2 x M5		For polyurethane tubing	
	\varnothing 4/2.5 x M5	M-5AU-4	For soft nylon and polyurethane tubing	
	\varnothing 6/4 x M5	M-5AU-6		
Barb elbow for nylon tubing 	\varnothing 4/2.5 x M5	M-5ALN-4	<ul style="list-style-type: none"> For nylon tubing Body rotates at 360° around the stud axis 	
	\varnothing 6/4 x M5	M-5ALN-6		
Barb elbow for soft tubing 	\varnothing 3.18/2.18 x M5	M-5ALU-3	Body rotates at 360° around the stud axis	For soft nylon tubing
	\varnothing 3.18/2 x M5			For polyurethane tubing
	\varnothing 4/2.5 x M5	M-5ALU-4		For soft nylon and polyurethane tubing
	\varnothing 6/4 x M5	M-5ALU-6		
Barb elbow (H) for nylon tubing 	\varnothing 4/2.5 x M5	M-5ALHN-4	<ul style="list-style-type: none"> For nylon tubing Body rotates at 360° around the stud axis 	
	\varnothing 6/4 x M5	M-5ALHN-6		
Barb elbow (H) for soft tubing 	\varnothing 3.18/2.18 x M5	M-5ALHU-3	Body rotates at 360° around the stud axis	For soft nylon tubing
	\varnothing 3.18/2 x M5			For polyurethane tubing
	\varnothing 4/2.5 x M5	M-5ALHU-4		For soft nylon and polyurethane tubing
	\varnothing 6/4 x M5	M-5ALHU-6		



Applicable tubing O.D.: \varnothing 3.18, \varnothing 4, \varnothing 6

Port size: M5

Description	Note	Model	Application
Hose nipple 	\varnothing 4/2.5 x M5	M-5H-4	For nylon, soft nylon and polyurethane tubing
	\varnothing 6/4 x M5	M-5H-6	
Hose elbow 	\varnothing 4/2.5 x M5	M-5HL-4	<ul style="list-style-type: none"> For nylon, soft nylon and polyurethane tubing
	\varnothing 6/4 x M5	M-5HL-6	
Hose elbow (H) 	\varnothing 4/2.5 x M5	M-5HLH-4	<ul style="list-style-type: none"> Body rotates at 360° around the stud axis
	\varnothing 6/4 x M5	M-5HLH-6	
Elbow 	M5 female x M5 female	M-5L	One-sided 90° elbow
Tee 	M5 female x M5 female x M5 female	M-5T	Both sides allow 90° connection
Universal elbow 	M5 female x M5 male	M-5UL	Body rotates at 360° around the stud axis
Universal tee 	M5 female x M5 female x M5 male	M-5UT	Body rotates at 360° around the stud axis
Extension fitting 	M5 male x M5 female	M-5J	Solid piece moves fitting up from workpiece
Nipple 	M5 male x M5 male	M-5N	Fitting to workpiece and fitting to fitting connection
Universal nipple 	M5 male x M5 male PAT.	M-5UN	Body rotates at 360° around the stud axis
Bulkhead union 	M5 x M5 female-female	M-5E	Panel-mount connection
Bulkhead reducer 	Rc 1/8 x M5 female	M-5ER	Reduction from Rc R 1/8 to M5 including panel or bracket mounting
Manifold 	Rc 1/8 x M5 female (9 stations)	M-5M	For reducing Rc R 1/8 female be diverted to up to 9, M5 stations, including panel or bracket mounting

Description	Note	Model	Application
Bushing 	R 1/8 x M5 female	M-5B	For reducing R R 1/8 female to M5.
	R 1/4 x M5 female	M-5B1	For reducing R R 1/4 female to M5.
Plug 		M-5P	Use to plug unused M5 port.
Gasket 	Material: Stainless steel, NBR	M-5G2	Seal on the M5 threads
Gasket (H) 	Material: Nylon 66, GF 30 %	M-5GH	M-5AL□-6 M-5ALH□-6 M-5HL-4, 6 M-5HLH-4, 6

Port size: R 1/8

Description	Note	Model	Application
Barb fitting for nylon tubing 	\varnothing 4/2.5 x R 1/8	M-01AN-4	For nylon tubing
	\varnothing 6/4 x R 1/8	M-01AN-6	
Barb fitting for soft tube 	\varnothing 4/2.5 x R 1/8	M-01AU-4	For soft nylon and polyurethane tubing
	\varnothing 6/4 x R 1/8	M-01AU-6	
Hose nipple 	\varnothing 4/2.5 x R 1/8	M-01H-4	For nylon, soft nylon and polyurethane tubing
	\varnothing 6/4 x R 1/8	M-01H-6	

 Note) For dimensions and other details refer to specific catalogue of the series at www.smc.eu



Made to Order

1 Gasket Material Modification

Symbol	Specifications	
X83	Gasket material: Stainless steel 304, NBR	
	Applicable thread	Gasket part no.
	M3	M-3G2
	M5 <small>Note)</small>	M-5G2
X226	Gasket material: Stainless steel 304, FKM	
	Applicable thread	Gasket part no.
	M3	M3G-DPH00489
X112	Gasket material: Stainless steel 316, Special FKM	
	Applicable thread	Gasket part no.
	M5	M-5G3

Note) Compatible with only models using M-5GH.

2 Clean Series

Symbol	Specifications
10-	Lubricant: Fluorine-based grease (Only M-5UN) Double package

Example) **10-M-5AN-4**

Spare Parts

Description	Part no.	Applicable thread	Material	Applicable model
Gasket	M-3G	M3	PVC	—
	M-3G2		Stainless steel 304, NBR	—
	M-5G1	M5	PVC	—
	M-5G2		Stainless steel 304, NBR	—
	M-5G3		Stainless steel 316, Special FKM	—
	M-5GH		Nylon 66, GF 30 %	M-5AL□-6, M-5ALH□-6 M-5HL-4, 6, M-5HLH4,6
	M-6G	M6	Stainless steel 304, NBR	For KQ2 M6 thread
	M-10/32G	10-32UNF		Series KQ2 10-32UNF
Cap nut	M-5-4-P01	—	C3604 (With electroless nickel plated)	M-01H-4, M-5H-4 M-5HL-4, M-5HLH-4
	M-5-6-P01	—	C3604 (With electroless nickel plated)	M-01H-6, M-5H-6 M-5HL-6, M-5HLH-6

Self-align Fittings

RoHS

Fittings

H/DL/L/LL Series

■ Applicable tubing O.D. : Metric Size

■ Connection thread : R, Rc

Spatter Proof

Flared ridge feRule

Prevents accidental loss of feRule when inserting tubing into the fitting body.

Hardened ridge feRule

Prevents breakage of feRule when tightening nut.

Flared I.D.

Provides low flow resistance inside the fitting.

Wide variety of styles and sizes

Ten styles and five tube O.D's provide a wide range of fittings that will fit any application.



Specifications

Applicable tubing material		Nylon, Soft nylon, Soft copper steel pipe (C1220T-0)
Applicable tubing O.D.		Ø 4, Ø 6, Ø 8, Ø 10, Ø 12
Maximum operating pressure		1 MPa
Proof pressure		10 MPa
Fluid		Air
Thread	Mounting section	JIS B0203 (Taper thread for piping)
	Nut section	JIS B0205 (Metric fine thread)
Seal on the threads ^{Note)}		None or with sealant

Note) Male elbow, Male branch tee, Male run tee with sealant is manufactured upon receipt of order. Suffix "S" to the end of part number if w/ sealant is desired.

Principal Parts Material

Body	C3604, C3771BE
Nut	C3604
FeRule	C2700

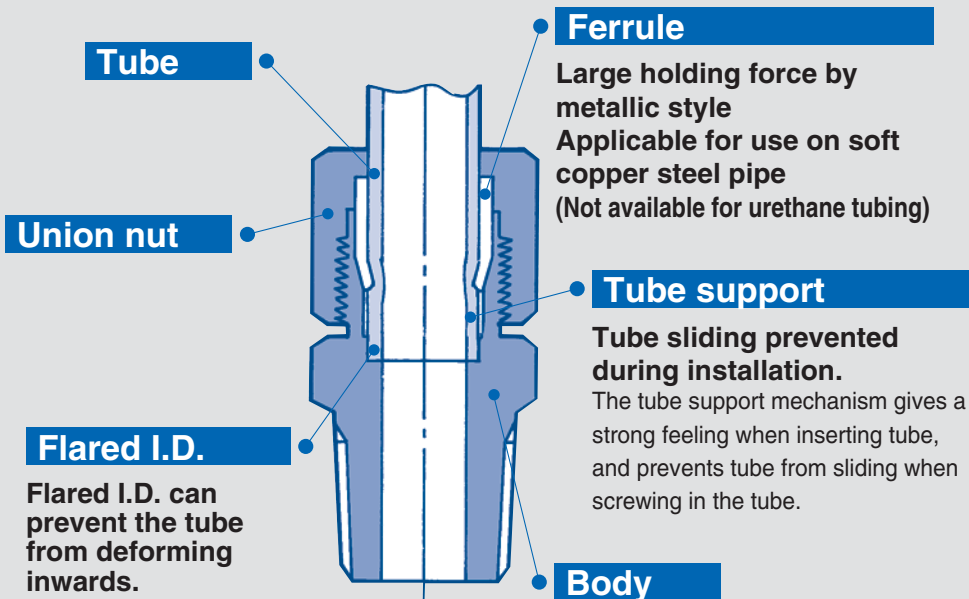

KQ2

KQ2-Uni

KQB2

KS/KX

KM

KF

M

H/DL/L/LL

KC

KK

KKH

KK 130

DM

DMK

KDM

MQR

KB

KR-W2

KRM

KA

KQG2

KG

KFG2

MS

KKA

KP

KPQ/KPG

LQ1

LQ3

LQHB

Male connector

H

Use to pipe a female thread.
Most general model.

Applicable tubing O.D. [mm]	Connection thread	Model
Ø 4	R 1/8	H04-01
	R 1/4	H04-02
Ø 6	R 1/8	H06-01
	R 1/4	H06-02
	R 3/8	H06-03
Ø 8	R 1/8	H08-01
	R 1/4	H08-02
	R 3/8	H08-03
Ø 10	R 1/4	H10-02
	R 3/8	H10-03
	R 1/2	H10-04
Ø 12	R 1/4	H12-02
	R 3/8	H12-03
	R 1/2	H12-04



Female connector

DHF

Use to pipe a male thread of a pressure gauge, etc.

Applicable tubing O.D. [mm]	Connection thread	Model
Ø 4	Rc 1/4	DHF04-02
	Rc 3/8	DHF04-03
Ø 6	Rc 1/4	DHF06-02
	Rc 3/8	DHF06-03
Ø 8	Rc 1/4	DHF08-02
	Rc 3/8	DHF08-03
Ø 10	Rc 1/4	DHF10-02
	Rc 3/8	DHF10-03
Ø 12	Rc 1/4	DHF12-02
	Rc 3/8	DHF12-03



Male branch tee

DT

Use to branch a female thread at both 90° angles.

Applicable tubing O.D. [mm]	Connection thread	Model
Ø 4	R 1/8	DT04-01
	R 1/4	DT04-02
Ø 6	R 1/8	DT06-01
	R 1/4	DT06-02
	R 3/8	DT06-03
Ø 8	R 1/8	DT08-01
	R 1/4	DT08-02
	R 3/8	DT08-03
Ø 10	R 1/4	DT10-02
	R 3/8	DT10-03
	R 1/2	DT10-04
Ø 12	R 1/4	DT12-02
	R 3/8	DT12-03
	R 1/2	DT12-04



Male elbow

DL

Use to pipe a female thread at right angles.
Most general model.

Applicable tubing O.D. [mm]	Connection thread	Model
Ø 4	R 1/8	DL04-01
	R 1/4	DL04-02
Ø 6	R 1/8	DL06-01
	R 1/4	DL06-02
	R 3/8	DL06-03
Ø 8	R 1/8	DL08-01
	R 1/4	DL08-02
	R 3/8	DL08-03
Ø 10	R 1/4	DL10-02
	R 3/8	DL10-03
	R 1/2	DL10-04
Ø 12	R 1/4	DL12-02
	R 3/8	DL12-03
	R 1/2	DL12-04



Male run tee

DY

Use to branch line in the same direction from female thread and in 90° direction.

Applicable tubing O.D. [mm]	Connection thread	Model
Ø 4	R 1/8	DY04-01
	R 1/4	DY04-02
Ø 6	R 1/8	DY06-01
	R 1/4	DY06-02
	R 3/8	DY06-03
Ø 8	R 1/8	DY08-01
	R 1/4	DY08-02
	R 3/8	DY08-03
Ø 10	R 1/4	DY10-02
	R 3/8	DY10-03
	R 1/2	DY10-04
Ø 12	R 1/4	DY12-02
	R 3/8	DY12-03
	R 1/2	DY12-04



Union tee

DT

Use to connect tubes in both 90° directions.

Applicable tubing O.D. [mm]	Model
Ø 4	DT04-00
Ø 6	DT06-00
Ø 8	DT08-00
Ø 10	DT10-00
Ø 12	DT12-00



Note) For dimensions and other details refer to specific catalogue of the series at www.smc.eu

Bulkhead union

DE

Use to connect tubing through a panel, etc.

Applicable tubing O.D. [mm]	Model
Ø 4	DE04-00
Ø 6	DE06-00
Ø 8	DE08-00
Ø 10	DE10-00
Ø 12	DE12-00



Bulkhead connector

DEF

Use to connect tubing through a panel, etc.

Applicable tubing O.D. [mm]	Connection thread	Model
Ø 6	Rc 1/4	DEF06-02
Ø 8	Rc 3/8	DEF08-03
Ø 10	Rc 3/8	DEF10-03
Ø 12	Rc 3/8	DEF12-03



Plug

DP

Use to plug unused fittings.

Applicable fitting size	Model
Ø 4	DP-04
Ø 6	DP-06
Ø 8	DP-08
Ø 10	DP-10
Ø 12	DP-12



Swivel elbow

L

Use to pipe at right angles to female thread. Swiveled at any direction.

Applicable tubing O.D. [mm]	Connection thread	Model
Ø 4	R 1/8	L04-01
	R 1/4	L04-02
Ø 6	R 1/8	L06-01
	R 1/4	L06-02
	R 3/8	L06-03
Ø 8	R 1/8	L08-01
	R 1/4	L08-02
	R 3/8	L08-03
Ø 10	R 1/4	L10-02
	R 3/8	L10-03
	R 1/2	L10-04
Ø 12	R 1/4	L12-02
	R 3/8	L12-03
	R 1/2	L12-04



Swivel extended elbow

LL

Use to pipe at right angles to female thread. Swiveled at any direction. Solid piece moves fittings up from workpiece.

Applicable tubing O.D. [mm]	Connection thread	Model
Ø 4	R 1/8	LL04-01
	R 1/4	LL04-02
Ø 6	R 1/8	LL06-01
	R 1/4	LL06-02
	R 3/8	LL06-03
Ø 8	R 1/8	LL08-01
	R 1/4	LL08-02
	R 3/8	LL08-03
Ø 10	R 1/4	LL10-02
	R 3/8	LL10-03
	R 1/2	LL10-04
Ø 12	R 1/4	LL12-02
	R 3/8	LL12-03
	R 1/2	LL12-04



Note) For dimensions and other details refer to specific catalogue of the series at www.smc.eu



Made to Order

1 Copper-free (With electroless nickel plated)

Symbol	Specifications
X2	Copper-free (With electroless nickel plated)

Suffix "-X2" to the end of part number.
Example) H04-01-X2

Self-seal Fittings

RoHS

KC Series

■ Applicable tubing O.D. : Metric Size

■ Connection thread : M, R, Rc

One-touch fitting (built-in self-seal mechanism) to prevent air exhaust when removing tube.

Best for multiple use areas when pressure cannot be shut down. 10 styles are available.

Copper-free applications

(With electroless nickel plated).

Sealant is standard.



Applicable Tubing

Tubing material	Nylon, Soft nylon, Polyurethane
Tubing O.D.	Ø 4, Ø 6, Ø 8, Ø 10, Ø 12

Specifications

Fluid	Air	
Maximum operating pressure	1 MPa	
Proof pressure	3 MPa	
Ambient and fluid temperature	-5 to 60 °C (No freezing)	
Thread	Mounting section	JIS B0203 (Taper thread for piping) JIS B0205 (Metric coarse thread)
	Nut section	JIS B0205 (Metric fine thread)
Seal on the threads (Standard)	With thread seal	
Copper-free (Standard)	Brass parts are all electroless nickel plated	

Before insertion of tubing

After insertion of tubing

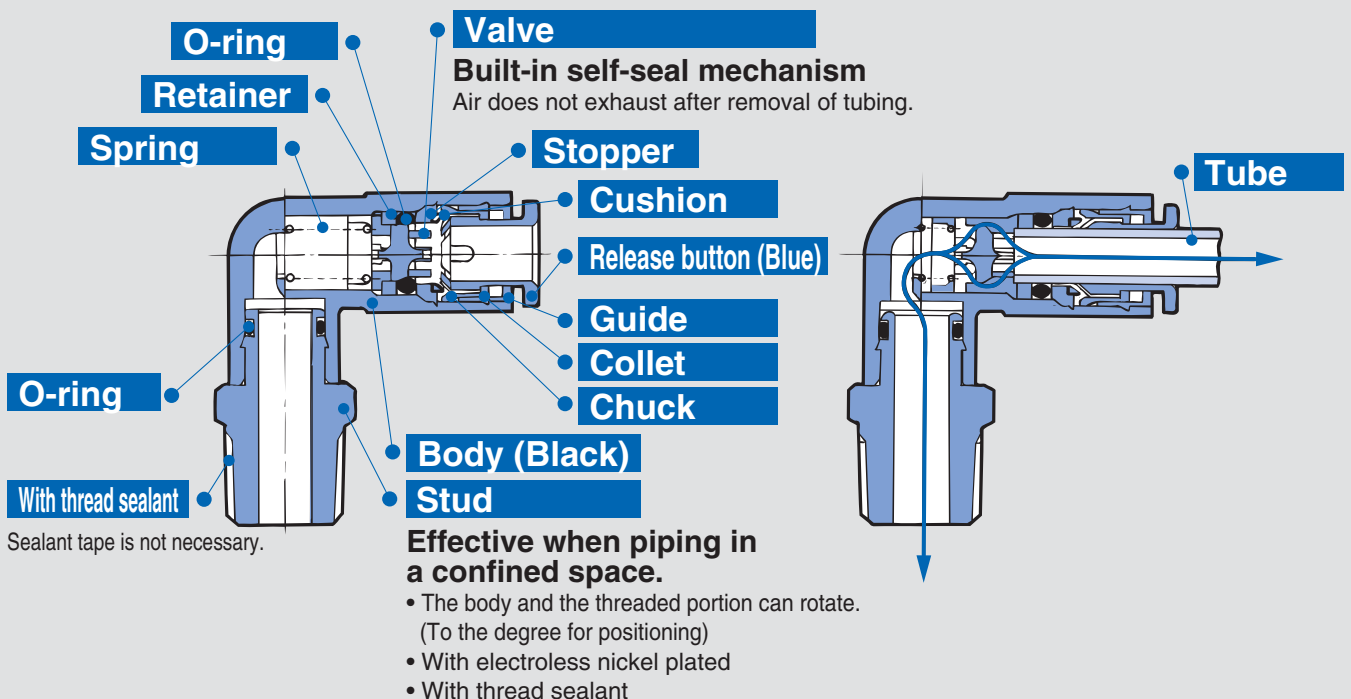

Male connector

KCH

Use to pipe in the same direction from female thread.

Applicable tubing O.D. [mm]	Connection thread	Model
Ø 4	M5 x 0.8	KCH04-M5
	R 1/8	KCH04-01S
Ø 6	M5 x 0.8	KCH06-M5
	R 1/8	KCH06-01S
	R 1/4	KCH06-02S
Ø 8	R 1/8	KCH08-01S
	R 1/4	KCH08-02S
	R 3/8	KCH08-03S
Ø 10	R 1/4	KCH10-02S
	R 3/8	KCH10-03S
Ø 12	R 3/8	KCH12-03S
	R 1/2	KCH12-04S

Bulkhead union

KCE

Use to connect tubes through a panel. One of two ports has a self-seal function.

Applicable tubing O.D. [mm]	Model
Ø 4	KCE04-00
Ø 6	KCE06-00
Ø 8	KCE08-00
Ø 10	KCE10-00
Ø 12	KCE12-00

Union tee

KCT

Use to connect tubes in both 90° directions.

Applicable tubing O.D. [mm]	Model
Ø 4	KCT04-00
Ø 6	KCT06-00
Ø 8	KCT08-00
Ø 10	KCT10-00
Ø 12	KCT12-00

Male elbow

KCL

Use to pipe at right angles to female thread.

Applicable tubing O.D. [mm]	Connection thread	Model
Ø 4	M5 x 0.8	KCL04-M5
	R 1/8	KCL04-01S
Ø 6	M5 x 0.8	KCL06-M5
	R 1/8	KCL06-01S
	R 1/4	KCL06-02S
Ø 8	R 1/8	KCL08-01S
	R 1/4	KCL08-02S
	R 3/8	KCL08-03S
Ø 10	R 1/4	KCL10-02S
	R 3/8	KCL10-03S
Ø 12	R 3/8	KCL12-03S
	R 1/2	KCL12-04S

Union "Y"

KCU

Use to branch line in the same direction. 2 branched ports has a self-seal function.

Applicable tubing O.D. [mm]	Model
Ø 4	KCU04-00
Ø 6	KCU06-00
Ø 8	KCU08-00
Ø 10	KCU10-00
Ø 12	KCU12-00

Straight union

KCH

Use to connect tubes in the same direction. One of two ports has a self-seal function.

Applicable tubing O.D. [mm]	Model
Ø 4	KCH04-00
Ø 6	KCH06-00
Ø 8	KCH08-00
Ø 10	KCH10-00
Ø 12	KCH12-00

Check adapter

KCJ

Use to add the self-seal mechanism to the usual One-touch fittings, Series KQ.

Applicable tubing O.D. [mm]	Model
Ø 4	KCJ04-99
Ø 6	KCJ06-99
Ø 8	KCJ08-99
Ø 10	KCJ10-99
Ø 12	KCJ12-99

Note) For dimensions and other details refer to specific catalogue of the series at www.smc.eu

- KQ2
- KQ2-Uni
- KQB2
- KS/KX
- KM
- KF
- M
- H/DL L/LL
- KC
- KK
- KKH
- KK 130
- DM
- DMK
- KDM
- MQR
- KB
- KR-W2
- KRM
- KA
- KQG2
- KG
- KFG2
- MS
- KKA
- KP
- KPQ/KPG
- LQ1
- LQ3
- LQHB

Straight plug for frequent use

KCH

It can save tube cutting labour in the case of frequent tube installation and removal.

Use to connect a self-seal fitting and a tube in the same direction.

	Applicable tubing O.D. [mm]	Model
	Ø 4	KCH04-99
Ø 6	KCH06-99	
Ø 8	KCH08-99	
Ø 10	KCH10-99	
Ø 12	KCH12-99	

Bulkhead connector

KCE

Use to connect male thread and tube through a panel.

	Applicable tubing O.D. [mm]	Connection thread	Model
	Ø 4	Rc 1/4	KCE04-02
Ø 6	Rc 1/4	KCE06-02	
Ø 8	Rc 3/8	KCE08-03	
Ø 10	Rc 3/8	KCE10-03	
Ø 12	Rc 3/8	KCE12-03	

Elbow plug for frequent use

KCL

It can save tube cutting labour in the case of frequent tube installation and removal.

Use to connect a self-seal fitting and a tube at the right angles to a self-seal fitting.

	Applicable tubing O.D. [mm]	Model
	Ø 4	KCL04-99
Ø 6	KCL06-99	
Ø 8	KCL08-99	
Ø 10	KCL10-99	
Ø 12	KCL12-99	

Note) For dimensions and other details refer to specific catalogue of the series at www.smc.eu

S Couplers

KK Series

RoHS

Fittings

■ Connection type: R, Rc, One-touch fitting, Nut fitting

Large effective area

Light weight

One-touch fitting type standardised

Four types from Ø 3.2 to Ø 16 added to series.

Flow is possible from the plug side or socket side.

Fluids: Air and Water

One-touch connection

Simple connection with one hand simplifies work.

Sleeve lock mechanism

Prevents accidents caused by unexpected separation.

Note) Except for M5 type (KK2 Series).

Specifications

Fluid	Air/Water
Operating pressure range ^{Note 1)}	KK2 : -100 kPa to 1 MPa KK3 : -90 kPa to 1 MPa KK4, 6: 0 to 1 MPa
Proof pressure	1.5 MPa
Ambient and fluid temperature	Air: -5 to 60 °C Water: 5 to 40 °C (No freezing)
Plating, Sealant	Electroless nickel plated (copper-free application), With male thread sealant

Note 1) Do not use the S couplers with a leak tester or for vacuum retention because they are not guaranteed for zero leakage.

Performance

Plug and socket connection	One-touch connection and release
Check valve	Socket: Built-in check valve (standard)
Sleeve lock mechanism ^{Note 2)}	Manual locking type (standard)

Note 2) KK2 Series is not provided with lock mechanism.

Series	Plug no.	Socket no.	Effective area [mm] ^{Note 3)}	Weight [g] ^{Note 4)}
KK2 Series	KK2P-M5M	KK2S-M5M	3.8	6.1
KK3 Series	KK3P-01MS	KK3S-01MS	20	20.1
KK4 Series	KK4P-02MS	KK4S-02MS	39	44.1
KK6 Series	KK6P-04MS	KK6S-04MS	82	90.1

Note 3) Values when plug and socket are connected. Note 4) Values for socket only.



Symbol

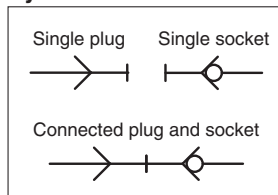

The pulling strength for the plugs and sockets has been improved.

Twice as strong as the conventional models

We standardised the product with a sleeve cover. Changing the lock ring material to a shock absorbent PBT further improved the shock absorbent performance.

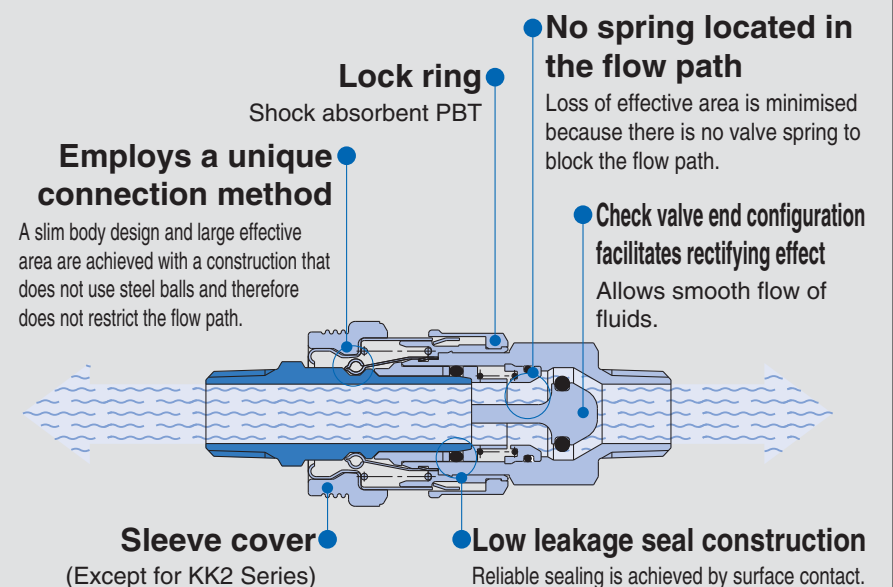



- KQ2
- KQ2-Uni
- KQB2
- KS/KX
- KM
- KF
- M
- H/DL L/LL
- KC
- KK
- KKH
- KK 130
- DM
- DMK
- KDM
- MQR
- KB
- KR-W2
- KRM
- KA
- KQG2
- KG
- KFG2
- MS
- KKA
- KP
- KPQ/KPG
- LQ1
- LQ3
- LQHB



Plug (P)

Socket (S)

Male thread type

	Body size	Port size	Model
KK2 	M5	M5 x 0.8	KK2P-M5M
		R 1/8	KK2P-01MS
	KK3-4-6 	1/8	R 1/8
R 1/4			KK3P-02MS
R 3/8			KK3P-03MS
1/4		R 1/8	KK4P-01MS
	R 1/4	KK4P-02MS	
	R 3/8	KK4P-03MS	
	R 1/2	KK4P-04MS	
	R 3/8	KK6P-03MS	
	R 1/2	KK6P-04MS	
	1/2	R 3/4	KK6P-06MS



Male thread type

	Body size	Port size	Model
KK2 	M5	M5 x 0.8	KK2S-M5M
		R 1/8	KK2S-01MS
	KK3-4-6 	1/8	R 1/8
R 1/4			KK3S-02MS
R 3/8			KK3S-03MS
1/4		R 1/8	KK4S-01MS
	R 1/4	KK4S-02MS	
	R 3/8	KK4S-03MS	
	R 1/2	KK4S-04MS	
	R 3/8	KK6S-03MS	
	R 1/2	KK6S-04MS	
	1/2	R 3/4	KK6S-06MS

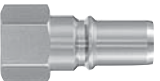
Female thread type

	Body size	Port size	Model
	M5	M5 x 0.8	KK2P-M5F
		Rc 1/8	KK3P-01F
	1/8	Rc 1/4	KK3P-02F
		Rc 3/8	KK3P-03F
		Rc 1/4	KK4P-02F
	1/4	Rc 3/8	KK4P-03F
		Rc 3/8	KK6P-03F
1/2	Rc 1/2	KK6P-04F	

Female thread type

	Body size	Port size	Model
KK2 	M5	M5 x 0.8	KK2S-M5F
		Rc 1/8	KK3S-01F
KK3-4-6 	1/8	Rc 1/4	KK3S-02F
		Rc 3/8	KK3S-03F
		Rc 1/4	KK4S-02F
1/4	1/4	Rc 3/8	KK4S-03F
		Rc 3/8	KK6S-03F
1/2	Rc 1/2	KK6S-04F	

Nut fitting type (for fiber reinforced urethane hose)

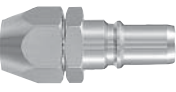
	Body size	Applicable hose I.D./O.D. [mm]	Model
	1/8	5 / 8	KK3P-50N
		6 / 9	KK3P-60N
		6.5 / 10	KK3P-65N
	1/4	5 / 8	KK4P-50N
		6 / 9	KK4P-60N
		6.5 / 10	KK4P-65N
		8 / 12	KK4P-80N
		8.5 / 12.5	KK4P-85N
	1/2	8 / 12	KK6P-80N
		8.5 / 12.5	KK6P-85N
		11 / 16	KK6P-110N

Nut fitting type (for fiber reinforced urethane hose)

	Body size	Applicable hose I.D./O.D. [mm]	Model
	1/8	5 / 8	KK3S-50N
		6 / 9	KK3S-60N
		6.5 / 10	KK3S-65N
	1/4	5 / 8	KK4S-50N
		6 / 9	KK4S-60N
		6.5 / 10	KK4S-65N
		8 / 12	KK4S-80N
		8.5 / 12.5	KK4S-85N
	1/2	8 / 12	KK6S-80N
		8.5 / 12.5	KK6S-85N
		11 / 16	KK6S-110N

Note) For dimensions and other details refer to specific catalogue of the series at www.smc.eu

Plug (P)

Straight type with One-touch fitting

Body size	Applicable tubing O.D. [mm]	Model
	M5	Ø 3.2
Ø 4		KK2P-04H
Ø 6		KK2P-06H
1/8	Ø 4	KK3P-04H
	Ø 6	KK3P-06H
	Ø 8	KK3P-08H
	Ø 10	KK3P-10H
1/4	Ø 6	KK4P-06H
	Ø 8	KK4P-08H
	Ø 10	KK4P-10H
	Ø 12	KK4P-12H
1/2	Ø 12	KK6P-12H
	Ø 16	KK6P-16H



Socket (S)

Straight type with One-touch fitting

Body size	Applicable tubing O.D. [mm]	Model
	M5	Ø 3.2
Ø 4		KK2S-04H
Ø 6		KK2S-06H
1/8	Ø 4	KK3S-04H
	Ø 6	KK3S-06H
	Ø 8	KK3S-08H
	Ø 10	KK3S-10H
1/4	Ø 6	KK4S-06H
	Ø 8	KK4S-08H
	Ø 10	KK4S-10H
	Ø 12	KK4S-12H
1/2	Ø 12	KK6S-12H
	Ø 16	KK6S-16H



Elbow type with One-touch fitting

Body size	Applicable tubing O.D. [mm]	Model
	M5	Ø 3.2
Ø 4		KK2P-04L
Ø 6		KK2P-06L
1/8	Ø 4	KK3P-04L
	Ø 6	KK3P-06L
	Ø 8	KK3P-08L
	Ø 10	KK3P-10L
1/4	Ø 6	KK4P-06L
	Ø 8	KK4P-08L
	Ø 10	KK4P-10L
	Ø 12	KK4P-12L
1/2	Ø 12	KK6P-12L
	Ø 16	KK6P-16L



Elbow type with One-touch fitting

Body size	Applicable tubing O.D. [mm]	Model
	M5	Ø 3.2
Ø 4		KK2S-04L
Ø 6		KK2S-06L
1/8	Ø 4	KK3S-04L
	Ø 6	KK3S-06L
	Ø 8	KK3S-08L
	Ø 10	KK3S-10L
1/4	Ø 6	KK4S-06L
	Ø 8	KK4S-08L
	Ø 10	KK4S-10L
	Ø 12	KK4S-12L
1/2	Ø 12	KK6S-12L
	Ø 16	KK6S-16L



Bulkhead type with One-touch fitting

Body size	Applicable tubing O.D. [mm]	Model
	M5	Ø 3.2
Ø 4		KK2P-04E
Ø 6		KK2P-06E
1/8	Ø 4	KK3P-04E
	Ø 6	KK3P-06E
	Ø 8	KK3P-08E
	Ø 10	KK3P-10E
1/4	Ø 6	KK4P-06E
	Ø 8	KK4P-08E
	Ø 10	KK4P-10E
	Ø 12	KK4P-12E
1/2	Ø 12	KK6P-12E
	Ø 16	KK6P-16E



Bulkhead type with One-touch fitting

Body size	Applicable tubing O.D. [mm]	Model
	M5	Ø 3.2
Ø 4		KK2S-04E
Ø 6		KK2S-06E
1/8	Ø 4	KK3S-04E
	Ø 6	KK3S-06E
	Ø 8	KK3S-08E
	Ø 10	KK3S-10E
1/4	Ø 6	KK4S-06E
	Ø 8	KK4S-08E
	Ø 10	KK4S-10E
	Ø 12	KK4S-12E
1/2	Ø 12	KK6S-12E
	Ø 16	KK6S-16E



Note) For dimensions and other details refer to specific catalogue of the series at www.smc.eu

S Couplers

RoHS

KKH Series

■ Connection type: R, Rc, One-touch fitting

Able to absorb drop impact (equivalent to impact energy of 0.5 J).

The pulling strength for the plugs and sockets has been improved. Twice as strong as the conventional models.

Same effective sectional area as that of Series KK.



Symbol

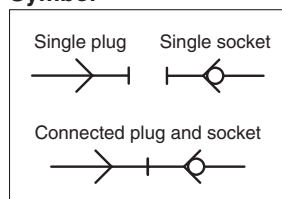

Specifications

Fluid	Air/Water
Operating pressure range ^{Note)}	KKH3: -90 kPa to 1 MPa KKH4: 0 to 1 MPa
Proof pressure	1.5 MPa
Ambient and fluid temperature	Air: -5 to 60 °C Water: 5 to 40 °C (No freezing)
Plating, Sealant	Electroless nickel plated (copper-free application), With male thread sealant
Connection plug	Series KK plug

Note) Do not use the S couplers with a leak tester or for vacuum retention because they are not guaranteed for zero leakage.

Performance

Plug and socket connection	One-touch connection and release
Check valve	Socket: Built-in check valve (standard)
Sleeve lock mechanism	None

Effective Area

Body size	Plug	Socket	Effective area [mm ²]
R 1/8	KK3P-01MS	KKH3S-01MS	20
R 1/4	KK4P-02MS	KKH4S-02MS	39

As the internal parts are the same as those for the standard product, the flow rate is equivalent to that of the standard product.

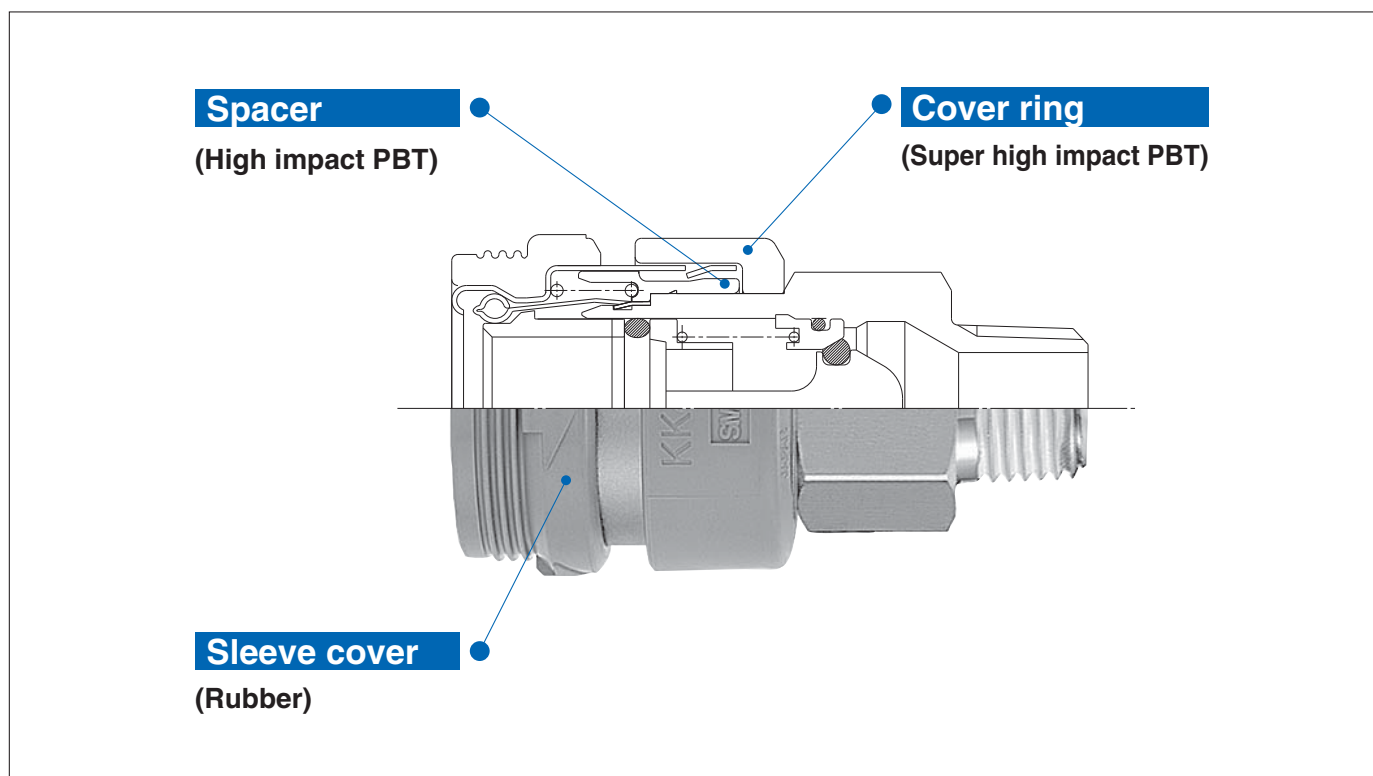

Plug (P)

Socket (S)

Male thread type

	Body size	Port size	Model
	1/8	R 1/8	KK3P-01MS
		R 1/4	KK3P-02MS
		R 3/8	KK3P-03MS
1/4	R 1/8	KK4P-01MS	
	R 1/4	KK4P-02MS	
	R 3/8	KK4P-03MS	
	R 1/2	KK4P-04MS	

Male thread type

	Body size	Port size	Model
	1/8	R 1/8	KKH3S-01MS
		R 1/4	KKH3S-02MS
		R 3/8	KKH3S-03MS
1/4	R 1/8	KKH4S-01MS	
	R 1/4	KKH4S-02MS	
	R 3/8	KKH4S-03MS	
	R 1/2	KKH4S-04MS	

Female thread type

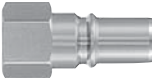
	Body size	Port size	Model
	1/8	Rc 1/8	KK3P-01F
		Rc 1/4	KK3P-02F
		Rc 3/8	KK3P-03F
1/4	Rc 1/4	KK4P-02F	
	Rc 3/8	KK4P-03F	

Female thread type

	Body size	Port size	Model
	1/8	Rc 1/8	KKH3S-01F
		Rc 1/4	KKH3S-02F
		Rc 3/8	KKH3S-03F
1/4	Rc 1/4	KKH4S-02F	
	Rc 3/8	KKH4S-03F	

Nut fitting type (for fiber reinforced urethane hose)

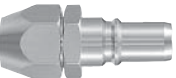
	Body size	Applicable hose I.D./O.D. mm	Model
	1/8	5 / 8	KK3P-50N
		6 / 9	KK3P-60N
		6.5 / 10	KK3P-65N
1/4	5 / 8	KK4P-50N	
	6 / 9	KK4P-60N	
	6.5 / 10	KK4P-65N	
	8 / 12	KK4P-80N	
	8.5 / 12.5	KK4P-85N	

Nut fitting type (for fiber reinforced urethane hose)

	Body size	Applicable hose I.D./O.D. mm	Model
	1/8	5 / 8	KKH3S-50N
		6 / 9	KKH3S-60N
		6.5 / 10	KKH3S-65N
1/4	5 / 8	KKH4S-50N	
	6 / 9	KKH4S-60N	
	6.5 / 10	KKH4S-65N	
	8 / 12	KKH4S-80N	
	8.5 / 12.5	KKH4S-85N	

Series KKH are only available as sockets.
Series KK should be used as plugs.

Note) For dimensions and other details refer to specific catalogue of the series at www.smc.eu

S Couplers

RoHS

KK130 Series

■ Connection type: R, Rc, Barb fitting, Nut fitting, One-touch fitting

Energy saving by pressure loss reduction

C factor increased by 34%

(Thread R 1/4 type, compared to the existing model*)

Plug insertion force reduced by 22 % (20 N)

(Compared to the existing model* at 0.5 MPa)

Lightweight reduced by 14 % (12 g)

(Compared to the existing model*)

One-touch fitting provided type is standardised.

With lock mechanism (Semi-standard)

* Existing model: Series KK13



Symbol

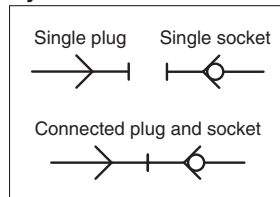

Specifications

Fluid	Air (Note)
Operating pressure range	0 to 1.5 MPa One-touch fitting type: 0 to 1 MPa
Proof pressure	2 MPa
Ambient and fluid temperature	-20 to 80 °C (No freezing) One-touch fitting type: -5 to 60 °C (No freezing)
Plating	Sleeve: Electroless nickel plated Other external metal parts: Zinc chromated
Sealant	Male thread with sealant

Note) Cannot be used for water.

Performance

Plug and socket connection	Sleeve slide detachable type
Check valve	Socket: Built-in check valve
Flow direction	Dual directional
Sleeve lock mechanism	Manual locking type (with detent) Semi-standard

Flow-rate Characteristics [Representative Value]

Connection type			Sonic conductance C [dm ³ /(s, bar)]	Critical pressure b	Flow coefficient Cv	Effective area S [mm ²]
Type	Symbol	Connection				
Male thread	-01MS	R 1/8	4.2	0.4	1.2	21
	-02MS	R 1/4	7.0	0.4	1.9	35
	-03MS	R 3/8	7.0	0.5	2.1	35
	-04MS	R 1/2	7.0	0.5	2.1	35
Female thread	-01F	Rc 1/8	6.0	0.5	1.8	30
	-02F	Rc 1/4	7.0	0.5	2.1	35
	-03F	Rc 3/8	7.0	0.5	2.1	35
	-04F	Rc 1/2	7.0	0.5	2.1	35
With barb fitting	-07B	6 (R 1/4")	2.0	0.4	0.5	10
	-09B	8 (R 1/4")	3.0	0.4	0.8	15
	-11B	10 (R 3/8")	6.0	0.5	1.8	30
	-13B	12 (R 1/2")	7.0	0.5	2.1	35
With nut fitting	-50N	5/8	2.0	0.4	0.5	10
	-60N	6/9	3.5	0.4	1.0	18
	-65N	6.5/10	4.2	0.4	1.2	21
	-80N	8/12	7.0	0.4	1.9	35
	-85N	8.5/12.5	7.0	0.4	1.9	35
With One-touch fitting	-110N	11/16	7.0	0.5	2.1	35
	-06H	Ø 6	2.0	0.4	0.5	10
	-08H	Ø 8	4.4	0.5	1.3	22
	-10H	Ø 10	7.0	0.5	1.8	35
	-12H	Ø 12	7.0	0.5	2.1	35

* The figures are representative values when the same type of plug and socket are connected.

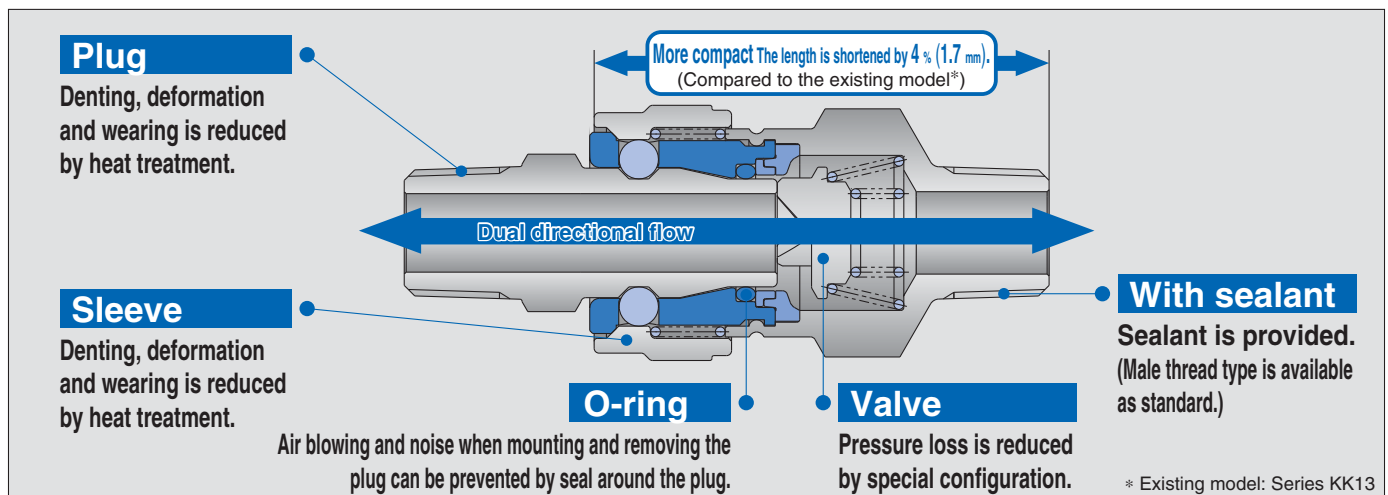

* Existing model: Series KK13

Plug (P)

Male thread type

	Port size	Model*
	R 1/8	KK130P-01MS
	R 1/4	KK130P-02MS
	R 3/8	KK130P-03MS
	R 1/2	KK130P-04MS

* With sealant

Female thread type

	Port size	Model
	Rc 1/8	KK130P-01F
	Rc 1/4	KK130P-02F
	Rc 3/8	KK130P-03F
	Rc 1/2	KK130P-04F

Barb fitting type (for rubber hose)

	Hose nominal*2	Model
	6 (1/4")	KK130P-07B
	8 (1/4")	KK130P-09B
	9 (3/8")	KK130P-11B
	12 (1/2")	KK130P-13B

*2 The figures in () indicate the internal diameter of the applicable hose.

Nut fitting type (for fiber reinforced urethane hose)

	Applicable hose I.D./O.D. [mm]	Model
	5 / 8	KK130P-50N
	6 / 9	KK130P-60N
	6.5 / 10	KK130P-65N
	8 / 12	KK130P-80N
	8.5 / 12.5	KK130P-85N
	11 / 16	KK130P-110N

One-touch fitting type

	Applicable tube O.D.	Model	
	Metric size mm	Ø 6	KK130P-06H
		Ø 8	KK130P-08H
		Ø 10	KK130P-10H
		Ø 12	KK130P-12H

Socket (S, L)

* Model with the sleeve lock mechanism is KK130L.

Male thread type

	Port size	Model*
	R 1/8	KK130S(L)-01MS
	R 1/4	KK130S(L)-02MS
	R 3/8	KK130S(L)-03MS
	R 1/2	KK130S(L)-04MS

* With sealant

Female thread type

	Port size	Model
	Rc 1/8	KK130S(L)-01F
	Rc 1/4	KK130S(L)-02F
	Rc 3/8	KK130S(L)-03F
	Rc 1/2	KK130S(L)-04F

Barb fitting type (for rubber hose)

	Hose nominal*2	Model
	6 (1/4")	KK130S(L)-07B
	8 (1/4")	KK130S(L)-09B
	9 (3/8")	KK130S(L)-11B
	12 (1/2")	KK130S(L)-13B

*2 The figures in () indicate the internal diameter of the applicable hose.

Nut fitting type (for fiber reinforced urethane hose)

	Applicable hose I.D./O.D. [mm]	Model
	5 / 8	KK130S(L)-50N
	6 / 9	KK130S(L)-60N
	6.5 / 10	KK130S(L)-65N
	8 / 12	KK130S(L)-80N
	8.5 / 12.5	KK130S(L)-85N
	11 / 16	KK130S(L)-110N

One-touch fitting type

	Applicable tube O.D.	Model	
	Metric size mm	Ø 6	KK130S(L)-06H
		Ø 8	KK130S(L)-08H
		Ø 10	KK130S(L)-10H
		Ø 12	KK130S(L)-12H

Note) For dimensions and other details refer to specific catalogue of the series at www.smc.eu

■ Applicable tubing O.D. : Metric Size

■ Connecting tube : 6, 12

One-touch installation and removal

Employs the unique built-in keying mechanism which provides one-touch installation and removal capability even in hard to see locations. In addition, it prevents installation mistakes when reconnecting.

Installation processes are reduced considerably

As compared with the use of many bulkhead unions, this installation is very easy and installation time is reduced considerably.

Reliable tube retaining force

This construction mechanism enables clamping and unclamping of every tube in use by one operation and can provide a reliable tube retaining force.

No. of connecting tubes

2 types—6 tubes & 12 tubes.

How to Order

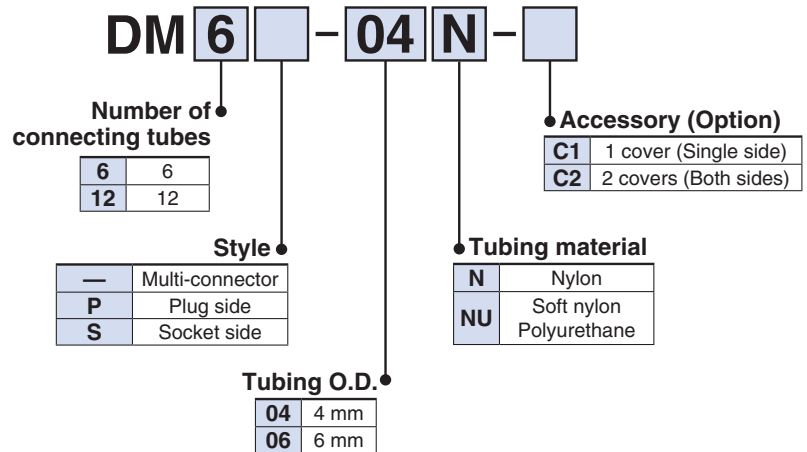

Specifications

Fluid	Air
Maximum operating pressure	1 MPa
Ambient and fluid temperature	-5 to 60 °C (No freezing)

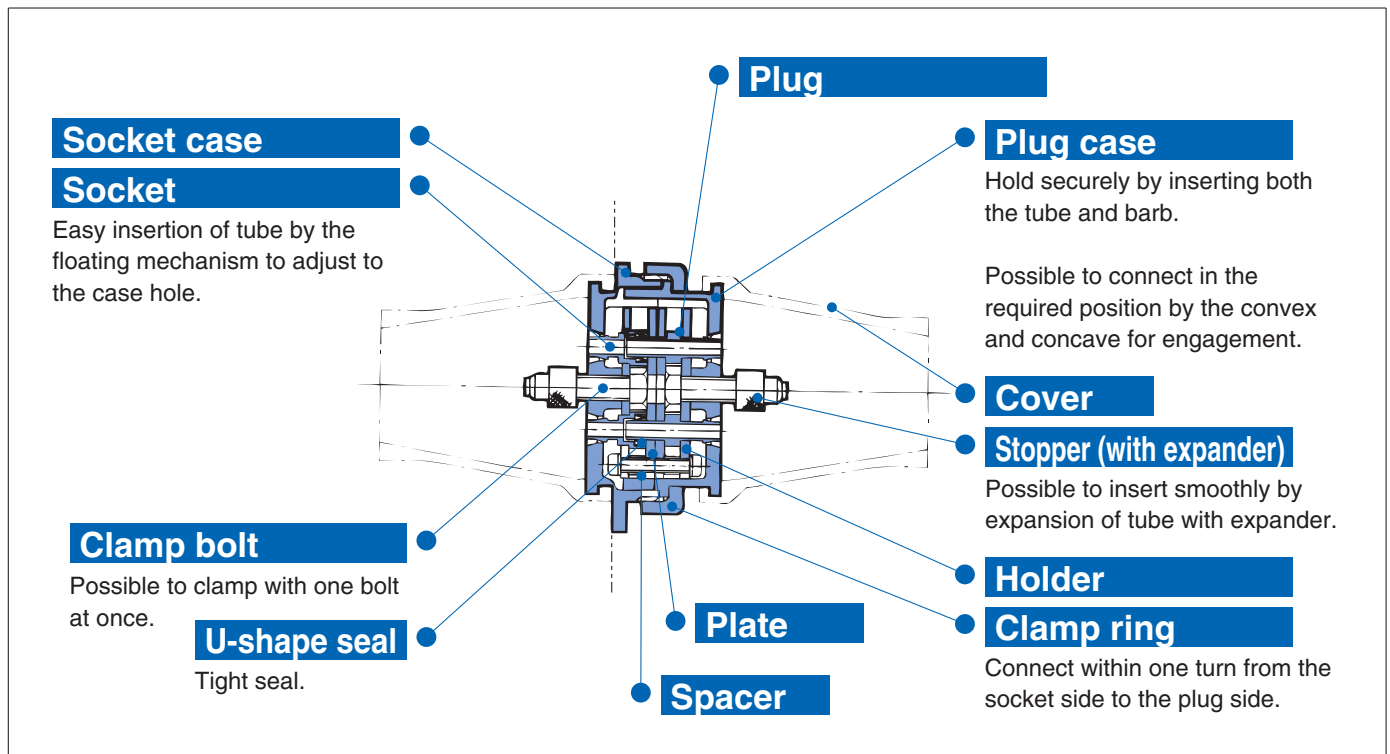

DM6



Number of connecting tubes	Applicable tubing O.D. [mm]	Model		
		Multi-connector	Plug side	Socket side
6	Ø 4	DM6-04N	DM6P-04N	DM6S-04N
		DM6-04NU	DM6P-04NU	DM6S-04NU
	Ø 6	DM6-06N	DM6P-06N	DM6S-06N
		DM6-06NU	DM6P-06NU	DM6S-06NU

DM12



Number of connecting tubes	Applicable tubing O.D. [mm]	Model		
		Multi-connector	Plug side	Socket side
12	Ø 4	DM12-04N	DM12P-04N	DM12S-04N
		DM12-04NU	DM12P-04NU	DM12S-04NU
	Ø 6	DM12-06N	DM12P-06N	DM12S-06N
		DM12-06NU	DM12P-06NU	DM12S-06NU

Note) For dimensions and other details refer to specific catalogue of the series at www.smc.eu



Made to Order

1 Metal: Brass/Electroless Nickel Plated

Symbol	Specifications
X2	Metal: Brass/Electroless nickel plated

Suffix "-X2" to the end of part number.

Example) DM6-04N-X2

Spare Parts

Description	Part no.	Number of connecting tubes
Cover	DM-C-6	6
	DM-C-12	12
Clamp ring	DM6-P01	6
	DM12-P01	12

Multi-connector with One-touch Fittings RoHS

DMK Series

■ Applicable tubing O.D. : Metric Size

■ Connecting tube : 6, 12

Built-in One-touch fittings

Applicable to nylon, soft nylon, and polyurethane tubes.

Saves installation time

Unlike the use of multiple bulkhead unions for panel, series DMK with built-in One-touch fittings significantly reduces the piping time.

Secure tube connection

Tubes are easily and securely connected to the multi-connector with built-in One-touch fittings.

No. of connecting tubes

2 types—6 tubes & 12 tubes.

How to Order

DMK 6 - **04** -

● Number of connecting tubes

6	6
12	12

● Accessory (Option)

—	None
C1	Cover single side 1 pc.
C2	Cover both sides 2 pcs.

● Style

—	Multi-connector
P	Plug side
S	Socket side

● Tubing O.D.

23	∅ 3.2
04	∅ 4

Specifications

Applicable tubing material	Nylon, Soft nylon, Polyurethane
Applicable tubing O.D. [mm]	∅ 3.2, ∅ 4
Fluid	Air
Maximum operating pressure	1 MPa
Ambient and fluid temperature	-5 to 60 °C (No freezing)

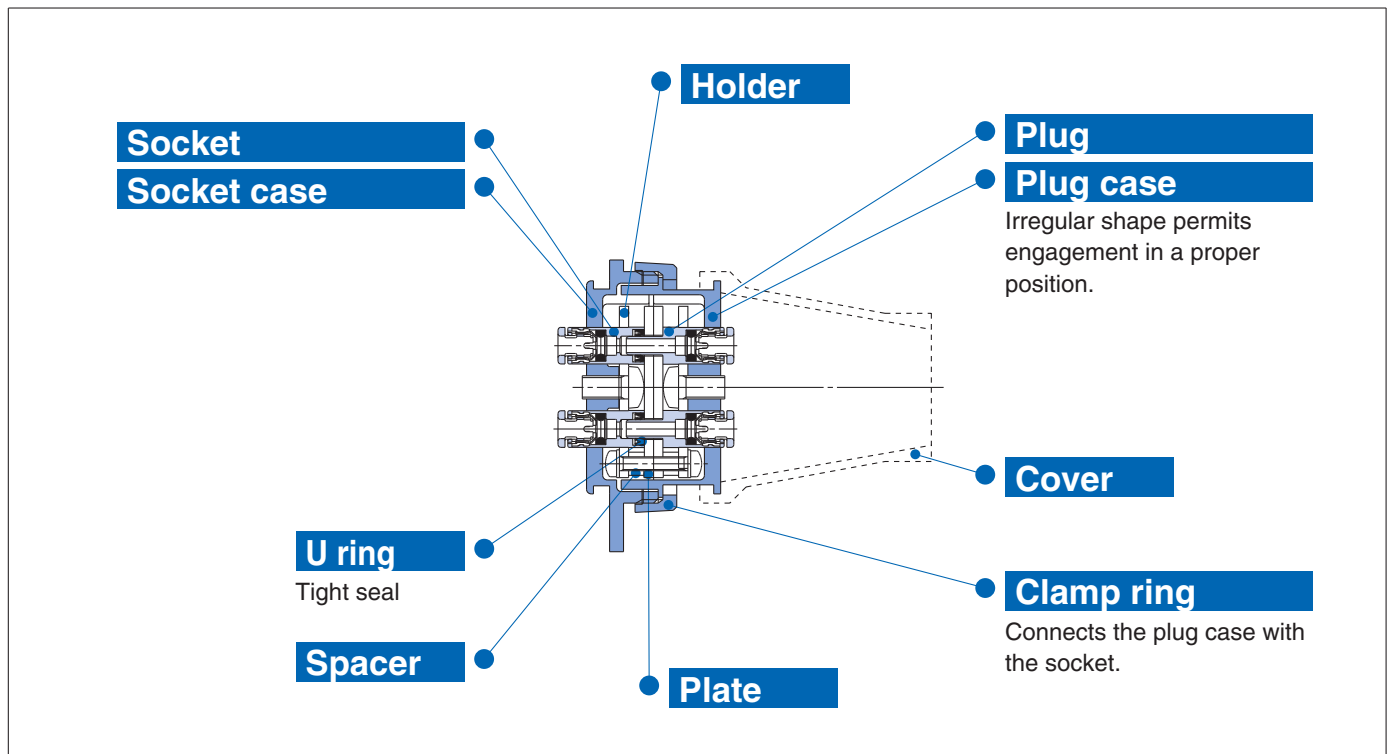

DMK6



With cover

Number of connecting tubes	Applicable tubing O.D. [mm]	Model		
		Multi-connector	Plug side	Socket side
6	Ø 3.2	DMK6-23	DMK6P-23	DMK6S-23
	Ø 4	DMK6-04	DMK6P-04	DMK6S-04

DMK12



Number of connecting tubes	Applicable tubing O.D. [mm]	Model		
		Multi-connector	Plug side	Socket side
12	Ø 3.2	DMK12-23	DMK12P-23	DMK12S-23
	Ø 4	DMK12-04	DMK12P-04	DMK12S-04

Note) For dimensions and other details refer to specific catalogue of the series at www.smc.eu

Spare Parts

Description	Part no.	Number of connecting tubes
Cover	DMK-C-6	6
	DMK-C-12	12
Clamp ring	DMK6-P01	6
	DMK12-P01	12

Rectangular Multi-connector

RoHS

KDM Series

■ Applicable tubing O.D. : Metric Size

■ Connecting tube : 10, 20

Substantial reduction in mounting space

In comparison with a model requiring many union joints for panels and partitions, this model needs only a small space.

One-touch connection/disconnection of connector

Multiple pipes can be connected/disconnected in one-touch operation without connection error. Thus man-hours for connection/disconnection are cut down substantially.

One-touch tube connection

One-touch fittings substantially cuts down man-hours for piping.

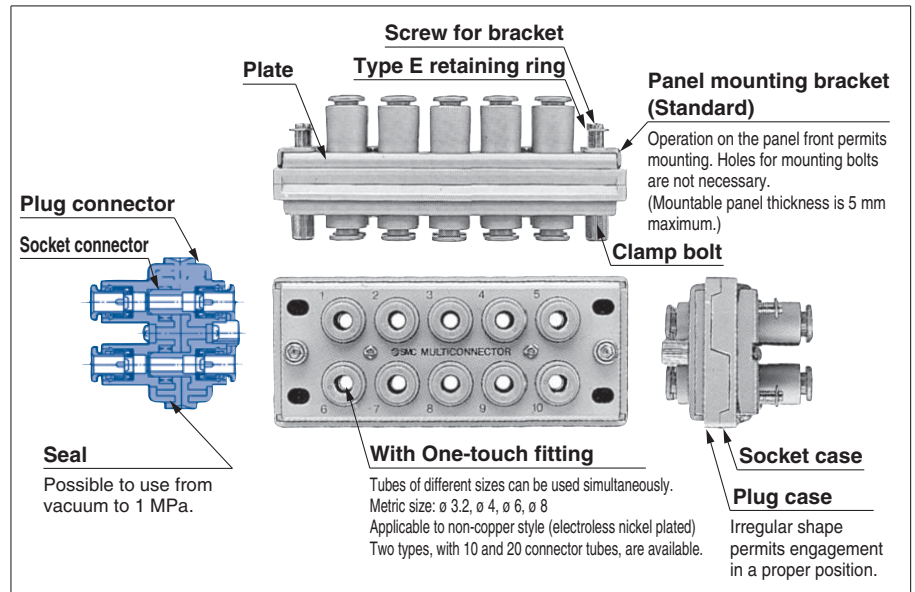

For inch size, refer to the **WEB catalogue** at www.smc.eu

Applicable Tubing

Tubing material	FEP, PFA, Nylon, Soft nylon, Polyurethane
Tubing O.D.	$\varnothing 3.2$, $\varnothing 4$, $\varnothing 6$, $\varnothing 8$

Specifications

Fluid	Air
Operating pressure range ^{Note)}	-100 kPa to 1 MPa
Proof pressure	1.5 MPa
Ambient and fluid temperature	-5 to 60 °C (No freezing)

Note) Please avoid using in a vacuum holding application such as a leak tester, since there is leakage.

KDM10			
	Number of connecting tubes	Applicable tubing O.D. [mm]	Model
	10	$\varnothing 3.2$	KDM10-23
		$\varnothing 4$	KDM10-04
		$\varnothing 6$	KDM10-06
		$\varnothing 8$	KDM10-08

KDM20			
	Number of connecting tubes	Applicable tubing O.D. [mm]	Model
	20	$\varnothing 3.2$	KDM20-23
		$\varnothing 4$	KDM20-04
		$\varnothing 6$	KDM20-06
		$\varnothing 8$	KDM20-08

Note) For dimensions and other details refer to specific catalogue of the series at www.smc.eu



Made to Order

1 Grease-free Specifications

Symbol	Specifications
X17	Grease-free Rubber material: NBR (With fluorine coating) Release button colour: Light blue
X39	Grease-free Rubber material: NBR (With fluorine coating) Release button colour: Light blue Clean (Copper-free, air blow, double package)

Suffix "-X17" to the end of part number.
Example) **KDM10-04-X17**

2 Other Specifications

Symbol	Specifications
X12	Lubricant: White vaseline Release button colour: White

3 Clean Series

Symbol	Specifications
10-	Metal: Brass/Electroless nickel plated (X2) Lubricant: Fluorine-based grease Double package

Example) **10-KDM10-23**

4 Mixed Tubing Size Type and Other Tubing Size

■ Mixed Tubing Size Type

Mixed tubing size manifolds are available to meet your individual requirements. Please consult with SMC for availability.

■ Other Tubing Size

Tubing size O.D.	Connection no.	Part no.
Ø 2	6	KDM6-02-X955-1
Ø 10	6	KDM6-10-X1053
Ø 10	10	KDM10-10-X1053
Ø 10	20	KDM20-10-X1053
Ø 12	6	KDM6-12-X1053
Ø 12	10	KDM10-12-X1053
Ø 12	20	KDM20-12-X1053

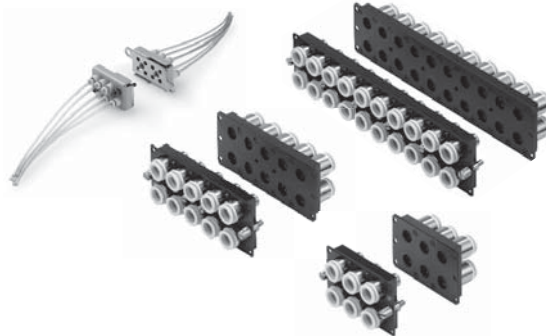

Note) For dimensions and other details refer to specific catalogue of the series at www.smc.eu

Low Torque Metal Seal Type Rotary Joint

RoHS

MQR Series

■ 1 circuit, 2 circuits, 4 circuits, 8 circuits, 12 circuits, 16 circuits



Long Service life

- MQR1:** 1 billion rotations
- MQR2:** 0.5 billion rotations
- MQR4:** 0.3 billion rotations
- MQR8:** 0.2 billion rotations
- MQR12:** 0.1 billion rotations
- MQR16:** 0.1 billion rotations

(Under SMC's life test conditions)

Low rotational torque: **0.003 to 0.50 N.m** or less

Allowable RPM: **200 to 3000 min⁻¹** (r.p.m.)

Operating temperature: **-10 to 80 °C**

How to Order

MQR F 4 - M5

- Low torque rotary joint (Metal seal tube)
- Options

—	Standard
F (Note)	Flange

Note) No flange type in 1 circuit system.
- Number of circuits

1	1 circuit
2	2 circuits
4	4 circuits
8	8 circuits
12	12 circuits
16	16 circuits
- Connection diameter

M5	M5 x 0.8
----	----------

Options/Mounting bracket

Number of circuits	Flange part number
2 circuits	MQR2-F
4 circuits	MQR4-F
8 circuits	MQR8-F
12 circuits	MQR12-F
16 circuits	MQR16-F

Specifications

Model		MQR1-M5	MQR2-M5	MQR4-M5	MQR8-M5	MQR12-M5	MQR16-M5
Number of circuits (Number of ports)		1	2	4	8	12	16
Fluid		Air / Inert gas					
Seal structure		Metal seal					
Guide structure		Bearing supported	Bearing supported at both ends				
Port size		Male R 1/8 Female M5	M5				
Flow rate characteristics	C[dm ³ /(s·bar)]	0.50					
	b	0.40					
	Cv	0.17					
	Q[l/min (ANR)] ^{Note 5)}	136					
Lubrication		Not required					
Min. operating pressure		-100 kPa					
Max. operating pressure		1.0 MPa					
Ambient temperature and operating fluid temperature ^{Note 1)}		-10 to 80 °C					
Max. start-up rotation torque ^{Note 2)}		0.003 N·m or less	0.03 N·m or less	0.05 N·m or less	0.10 N·m or less	0.20 N·m or less	0.50 N·m or less
Allowable rotation number		3000 min ⁻¹ (r.p.m.) or less ^{Note 3)}	2000 min ⁻¹ (r.p.m.) or less	1500 min ⁻¹ (r.p.m.) or less	900 min ⁻¹ (r.p.m.) or less	600 min ⁻¹ (r.p.m.) or less	200 min ⁻¹ (r.p.m.) or less
Allowable radial load (allowable coupling axis reaction) ^{Note 4)}		1 N or less	15 N or less	30 N or less	40 N or less	50 N or less	50 N or less
Allowable axial load							
Weight		0.025 kg	0.16 kg	0.39 kg	0.76 kg	1.26 kg	2.80kg

Note 1) The temperature 80 °C includes temperature rise during rotation.

Note 2) The start-up torque does not change with the supply pressure or with non-use (remains within the maximum start-up rotation torque), but it does change with the rotation number.

Note 3) If using at a speed above 600 min⁻¹ (r.p.m.), ensure rotation is in the direction in which the joint is fastened.

Note 4) Rubber / resin couplings are recommended due to their excellent absorption of off center, shocks, and vibrations.

Note 5) This value has been calculated according to the ISO 6358 and represents the flow rate measured in standard conditions at an upstream pressure of 6 bar (relative pressure) and a differential of pressure of 1bar.

Applications: Air supply to rotary/pivot shafts of turntables and robot arms

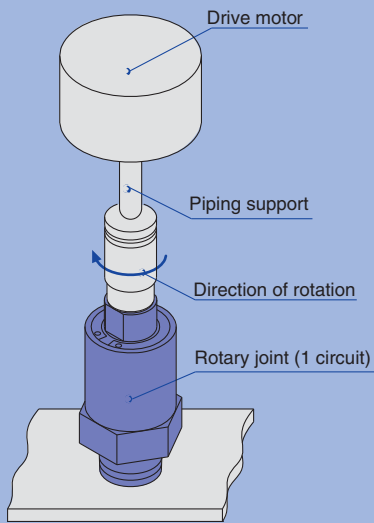

Example of 1 circuit

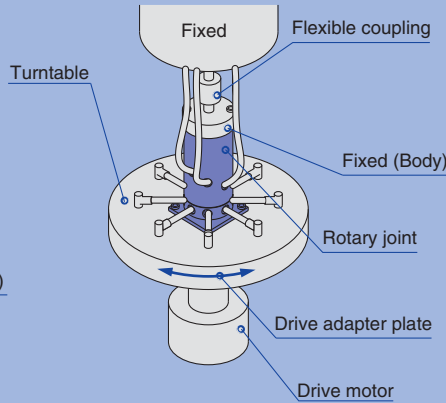

Example of adapter plate drive

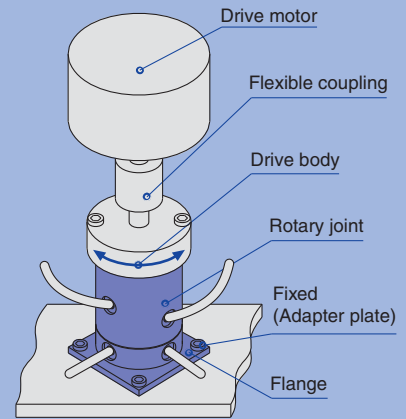

- This series cannot be used for drive transmission.

Example of body drive

Made to Order

- Contact SMC if you wish to use rotary joints at temperatures outside the range of -10 °C to 80 °C or to have joints made with 20 circuits or more or a through hole specification.

KQ2

KQ2-
Uni

KQB2

KS/
KX

KM

KF

M

H/DL
L/LL

KC

KK

KKH

KK
130

DM

DMK

KDM

MQR

KB

KR
-W2

KRM

KA

KQG2

KG

KFG2

MS

KKA

KP

KPQ/
KPG

LQ1

LQ3

LQHB

Rubber Seal Type Rotary Joint

RoHS

MQR-X229 Series

■ Rubber seal, 8 circuits

- Oldham coupling
- Operating pressure range:
-100 kPa to 0.7 MPa
- Allowable rpm: 200 min⁻¹*1
- Max. start-up rotation torque:
0.50 N·m*2 or less
- Service life: 10 million rotations*3
- Number of circuits: 8 circuits

*1 Reference value

*2 When no pressure applied.

*3 Under SMC's life test conditions.



Option/Mounting Bracket

Number of circuits	Flange part number
8 circuits	MQR8-F-X229

Specifications

Number of circuits (Number of ports)		8 circuits
Fluid		Air
Seal structure		Rubber seal
Guide structure		Bearing supported at both ends
Flow-rate characteristics	C	0.50 [dm ³ /(s·bar)]
	b	0.40
	Cv	0.17
	Q	136 [l/min (ANR)] Note 4)
Lubrication		Not required
Minimum operating pressure		-100 kPa (10 Torr)
Maximum operating pressure		0.7 MPa
Ambient temperature		5 to +40 °C Note 1) Note 2)
Fluid temperature		5 to +40 °C Note 1) Note 2)
Start-up torque (Reference value) Note 3)	When no pressure applied	0.5 N·m or less
	When 0.7 MPa pressure applied	0.8 N·m or less
Allowable rpm (Reference value)		200 min ⁻¹
Weight		0.53 kg

Note 1) Temperature rise: 50 °C

<Conditions>

· Supply pressure: 0.7 MPa

· Rotation number: 200 min⁻¹(rpm)

Example) When the ambient temperature is 20 °C, the surface temperature of the rotary joint is 70 °C.

Note 2) The surface temperature of the rotary joint should not be more than 80 °C. (Including the heat generated by adiabatic compression, etc.)

Note 3) The start-up torque may increase temporarily depending on the period of non-operation. For rotational torque with rotation number, refer to "Change in Rotational Torque with Rotation Number".

Note 4) This value has been calculated according to the ISO 6358 and represents the flow rate measured in standard conditions at an upstream pressure of 6 bar (relative pressure) and a differential of pressure of 1 bar.

How to Order

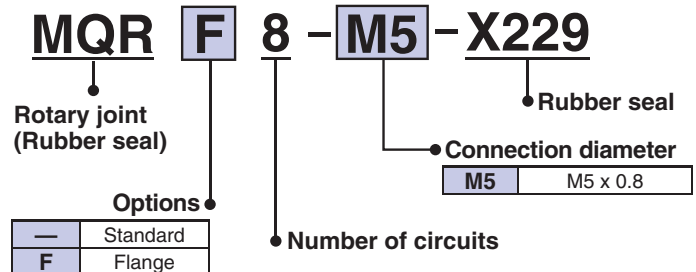

Related Equipment

Low Torque Rotary Joint

MQR Series

- Metal seal type
- Long service life *



Series	Service life	Series	Service life
MQR1	1 billion rotations	MQR8	0.2 billion rotations
MQR2	0.5 billion rotations	MQR12	0.1 billion rotations
MQR4	0.3 billion rotations	MQR16	0.1 billion rotations

* Under SMC's life test conditions.

- Max. start-up rotation torque: 0.003 to 0.50 N·m or less

Rotary Selector Valve

MQRV Series

■ A single selector valve enables up to 9 pressures to checked.

Please contact SMC for availability



Surface

Specifications

Number of ports	10 circuits Input port: 9 circuits, Output port: 1 circuit
Fluid	Air, Inert gas
Seal structure	Metal seal
Lubricant	Not required
Min. operating pressure	-100 kPa
Max. operating pressure	1.0 MPa
Ambient temperature	-10 to 80 °C
Fluid temperature	-10 to 80 °C

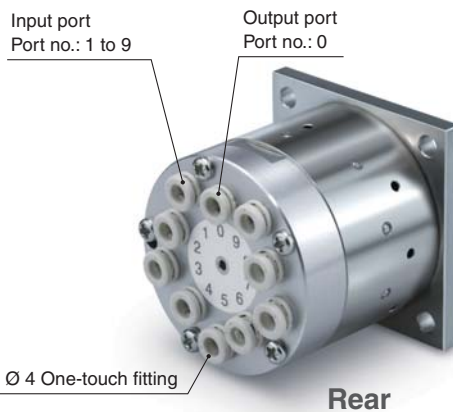

Rear

Symbol

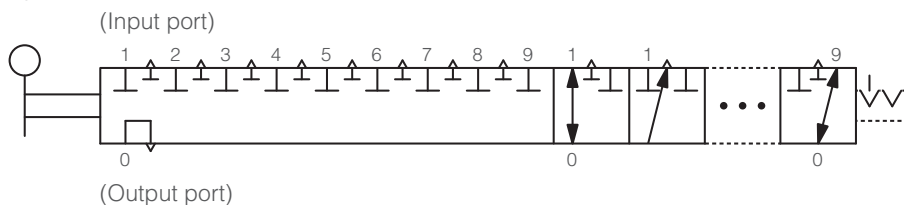

Application

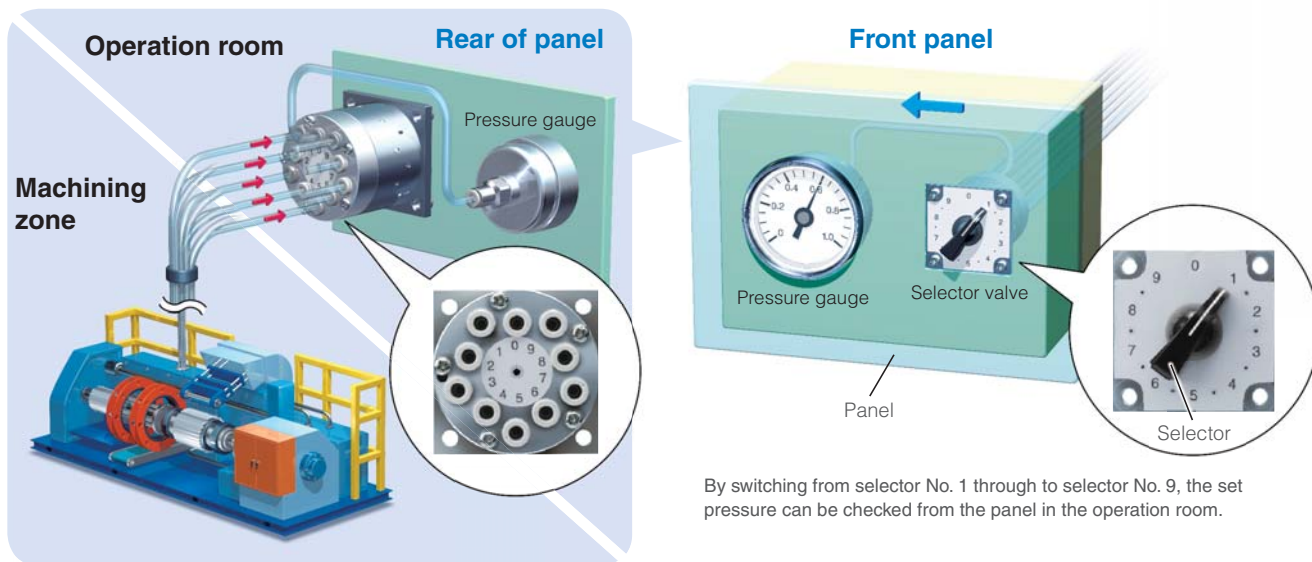

■ Applicable tubing O.D. : Metric Size

■ Connection thread : M, R, Rc

Suitable for centralised distribution of supply air

Easy distribution utilising One-touch fittings

One-touch fitting installation without the use of tools

Locking system makes the use of tools unnecessary and piping more efficient.

Air output direction possible through 360°

Universal construction allows for changes in air output direction after connections are completed.

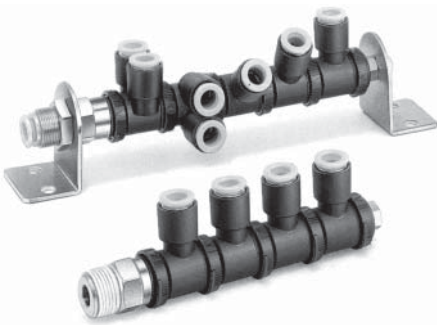

Applicable Tubing

Tubing material	Nylon, Soft nylon, Polyurethane, FEP, PFA
Tubing O.D.	Ø 4, Ø 6, Ø 8, Ø 10, Ø 12, Ø 16

Applicable Thread Size

Male thread	R 1/8, R 1/4, R 3/8, R 1/2
Female thread	M5 x 0.8, M6 x 1, Rc 1/8, Rc 1/4, Rc 3/8, Rc 1/2

Specifications

Fluid	Air	
Operating pressure range ^{Note)}	-100 kPa to 1 MPa	
Proof pressure	3 MPa	
Ambient and fluid temperature	-5 to 60 °C (No freezing)	
Thread	Mounting section	JIS B0203 (Taper thread for piping) JIS B0205 (Metric coarse thread)
	Nut section	JIS B0205 (Metric fine thread)
Seal on the threads (Standard)	With thread seal	
Copper-free (Standard)	Brass parts are all electroless nickel plated	

Note) Do not use the S couplers with a leak tester or for vacuum retention because they are not guaranteed for zero leakage.

Principal Parts Material

Body	C3604, PBT, POM
Stud	POM
Lock ring	POM
Spring	Stainless steel 304
Spring guide	POM
Stopper	POM
Thread	C3604
Guide	Stainless steel 304, PBT
Collet, Release button	POM
Seal, O-ring	NBR
Chuck	Stainless steel 304

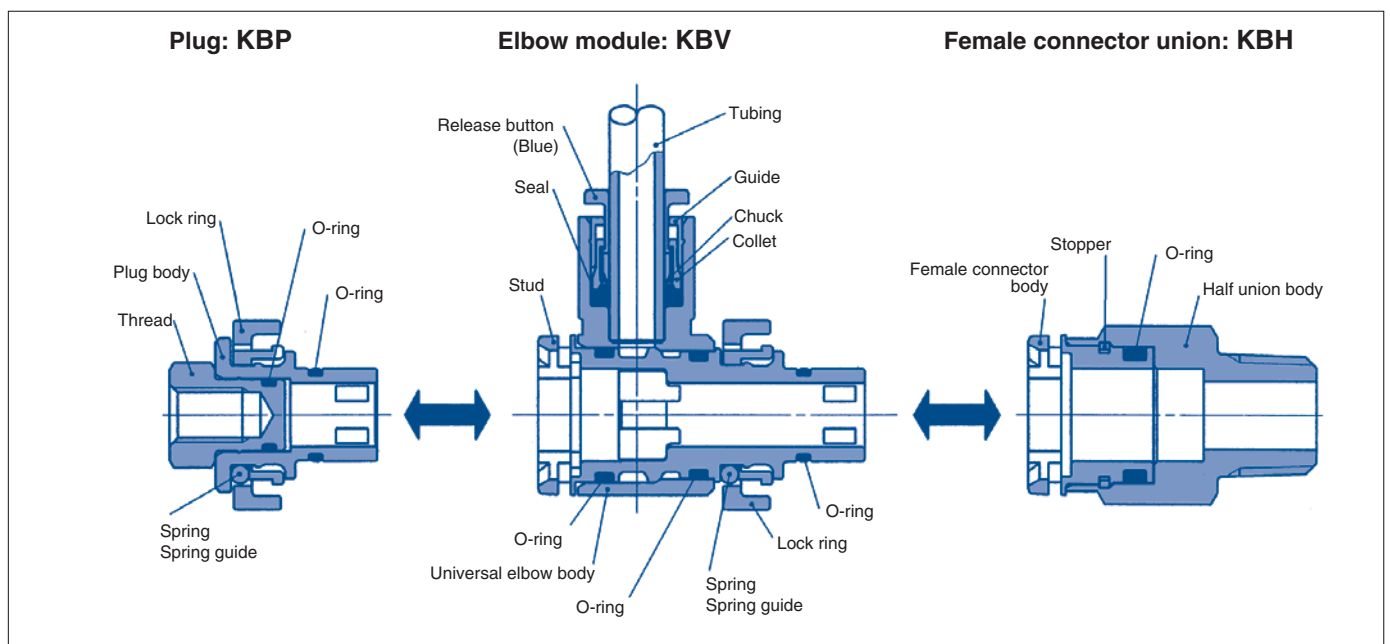

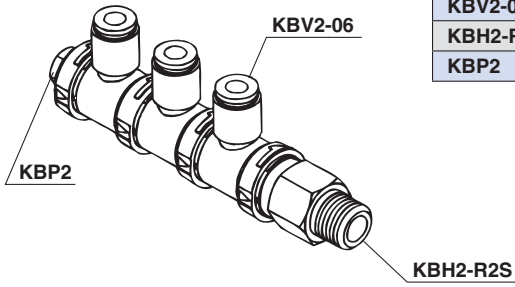

Component module	No. of pcs.
KBV2-06	3
KBH2-R2S	1
KBP2	1

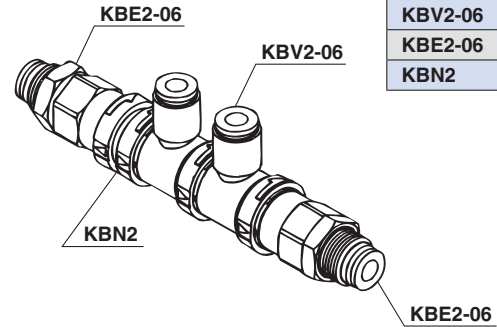

Component module	No. of pcs.
KBV2-06	2
KBE2-06	2
KBN2	1

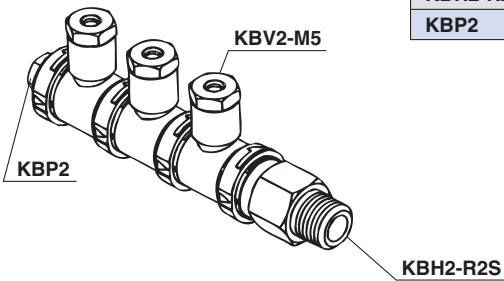

Component module	No. of pcs.
KBV2-M5	3
KBH2-R2S	1
KBP2	1

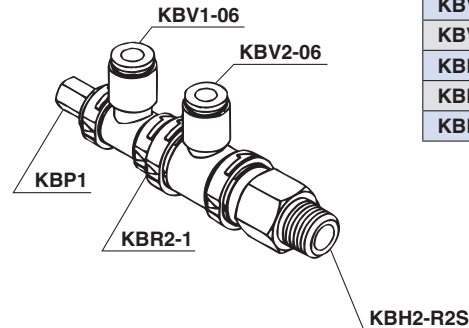

Component module	No. of pcs.
KBV2-06	1
KBV1-06	1
KBR2-1	1
KBH2-R2S	1
KBP1	1

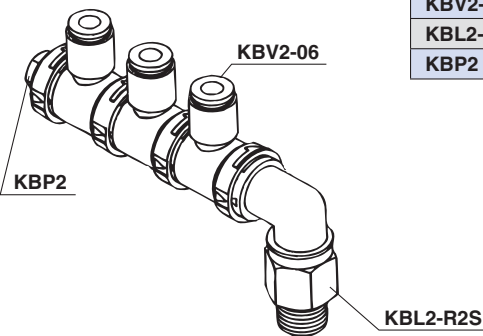

Component module	No. of pcs.
KBV2-06	3
KBL2-R2S	1
KBP2	1

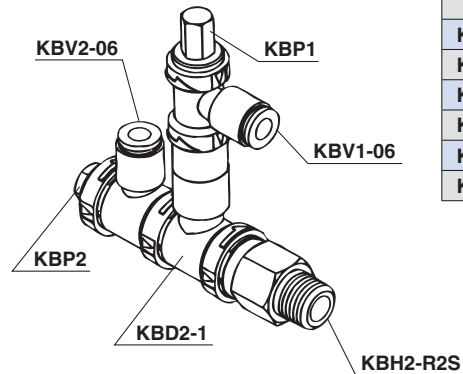

Component module	No. of pcs.
KBV2-06	1
KBV1-06	1
KBD2-1	1
KBH2-R2S	1
KBP2	1
KBP1	1

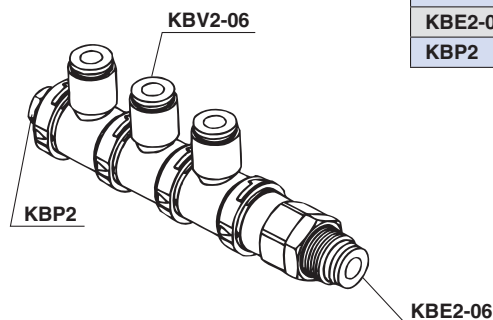



Component module	No. of pcs.
KBV2-06	3
KBE2-06	1
KBP2	1

When the piping modules have the same body size number, they can be combined. When combining modules with different body size numbers, convert the size with the different diameter module (KBR).

- KQ2
- KQ2-Uni
- KQB2
- KS/KX
- KM
- KF
- M
- H/DL L/LL
- KC
- KK
- KKH
- KK 130
- DM
- DMK
- KDM
- MQR
- KB**
- KR-W2
- KRM
- KA
- KQG2
- KG
- KFG2
- MS
- KKA
- KP
- KPQ/KPG
- LQ1
- LQ3
- LQHB

Elbow module		KBV	
	Body size	Applicable tubing O.D. [mm]	Model
	1	Ø 4	KBV1-04
	1	Ø 6	KBV1-06
	2	Ø 6	KBV2-06
	2	Ø 8	KBV2-08
	3	Ø 8	KBV3-08
	3	Ø 10	KBV3-10
	3	Ø 12	KBV3-12
	4	Ø 12	KBV4-12
	4	Ø 16	KBV4-16

Branch elbow module		KBZ	
	Body size	Applicable tubing O.D. [mm]	Model
	1	Ø 4	KBZ1-04
	1	Ø 6	KBZ1-06
	2	Ø 8	KBZ2-08
	3	Ø 10	KBZ3-10
	3	Ø 12	KBZ3-12
	4	Ø 12	KBZ4-12

Elbow socket module		KBV	
	Body size	Connection thread	Model
	1	M5 x 0.8	KBV1-M5
	1	M6 x 1.0	KBV1-M6
	2	M5 x 0.8	KBV2-M5
	2	M6 x 1.0	KBV2-M6
	2	Rc 1/8	KBV2-R1
	3	Rc 1/8	KBV3-R1
	3	Rc 1/4	KBV3-R2
	4	Rc 1/4	KBV4-R2
	4	Rc 3/8	KBV4-R3

Note) For dimensions and other details refer to specific catalogue of the series at www.smc.eu

Female connector union

KBH

Body size	Connection thread	Model
1	R 1/8	KBH1-R1S
2	R 1/4	KBH2-R1S
2	R 1/4	KBH2-R2S
2	R 3/8	KBH2-R3S
3	R 1/4	KBH3-R2S
3	R 3/8	KBH3-R3S
3	R 1/2	KBH3-R4S
4	R 3/8	KBH4-R3S
4	R 1/2	KBH4-R4S



Male connector socket

KBB

Body size	Connection thread	Model
1	M5 x 0.8	KBB1-M5
2	M6 x 1.0	KBB2-M6
3	Rc 1/8	KBB3-R1
4	Rc 1/4	KBB4-R2



Female connector socket

KBS

Body size	Connection thread	Model
1	Rc 1/8	KBS1-R1
2	Rc 1/4	KBS2-R2
3	Rc 3/8	KBS3-R3
4	Rc 1/2	KBS4-R4



Female connector elbow union

KBL

Body size	Connection thread	Model
1	R 1/8	KBL1-R1S
2	R 1/4	KBL2-R1S
2	R 1/4	KBL2-R2S
2	R 3/8	KBL2-R3S
3	R 1/4	KBL3-R2S
3	R 3/8	KBL3-R3S
3	R 1/2	KBL3-R4S
4	R 3/8	KBL4-R3S
4	R 1/2	KBL4-R4S



Note) For dimensions and other details refer to specific catalogue of the series at www.smc.eu

Bulkhead female connector

KBE

Body size	Applicable tubing O.D. [mm]	Connection thread	Model
1	Ø 4	M12 x 1.0	KBE1-04
1	Ø 6	M14 x 1.0	KBE1-06
2	Ø 6	M14 x 1.0	KBE2-06
2	Ø 8	M16 x 1.0	KBE2-08
2	Ø 10	M20 x 1.0	KBE2-10
3	Ø 8	M16 x 1.0	KBE3-08
3	Ø 10	M20 x 1.0	KBE3-10
3	Ø 12	M22 x 1.0	KBE3-12
4	Ø 12	M22 x 1.0	KBE4-12



KQ2

KQ2-Uni

KQB2

KS/KX

KM

KF

M

H/DL
L/LL

KC

KK

KKH

KK
130

DM

DMK

KDM

MQR

KB

KR
-W2

KRM

KA

KQG2

KG

KFG2

MS

KKA

KP

KPQ/
KPG

LQ1

LQ3

LQHB

Nipple		KBN	
	Body size	Model	
	1	KBN1	
	2	KBN2	
	3	KBN3	
4	KBN4		

Cap		KBC	
	Body size	Model	
	1	KBC1	
	2	KBC2	
	3	KBC3	
4	KBC4		

Elbow different diameter female connector module			KBD	
	Body size	Body size	Model	
	2	1	KBD2-1	
	3	2	KBD3-2	
	4	3	KBD4-3	

Bracket		KBX	
	Applicable model	Model	
	KBP, KBC	KBX6	
	KBE1-04	KBX12	
	KBE1-06, KBE2-06	KBX14	
	KBE2-08, KBE3-08	KBX16	
	KBE2-10, KBE3-10	KBX20	
KBE3-12, KBE4-12	KBX22		

Different diameter module			KBR	
	Body size	Body size	Model	
	2	1	KBR2-1	
	3	2	KBR3-2	
	4	3	KBR4-3	

* In the case of KBX6, use the enclosed mounting screws designed for KBP (plug) and KBC (cap).
Screw size: Cross recessed round head screw (M6 x 1 x 8L) Screw colour: Black

Plug		KBP	
	Body size	Model	
	1	KBP1	
	2	KBP2	
	3	KBP3	
4	KBP4		

Note) For dimensions and other details refer to specific catalogue of the series at www.smc.eu

KR-W2 Series

■ Applicable tubing O.D. : **Metric Size**

■ Connection thread : **R, Rc**

Spatter Proof



Applicable Tubing

Tubing material	FR double layer, FR soft nylon
Tubing O.D.	Ø 6, Ø 8, Ø 10, Ø 12

Specifications

Fluid	Air/Water <small>Note 1)</small>	
Operating pressure range <small>Note 2)</small>	-100 kPa to 1 MPa	
Proof pressure	3 MPa	
Ambient and fluid temperature	-5 to 60 °C, Water: 0 to 60 °C (No freezing)	
Thread	Mounting section	JIS B0203 (Taper thread for piping)
	Nut section	JIS B0205 (Metric fine thread)
Seal on the threads	With sealant (Standard)	

Note 1) The surge pressure must be under the maximum operating pressure.

Note 2) Do not use the fittings with a leak tester or for vacuum retention because they are not guaranteed for zero leakage.

Guide

Collet

Chuck

Accepts FR soft nylon.
Large retaining force.
The chuck provides secure retention and the collet increases the holding force on the tube.

Seal

Can be used for a wide range of pressures from a low vacuum up to a pressure of 1 MPa. The use of a special profile ensures sealing and reduces resistance when the tube is inserted.

With thread sealant

Pipe tape is not necessary.

Cover (Option)

Prevention of tube releasing unconformity due to inside intrusions or adhesion of the spatter. For cover, refer to page 121.

Release button (White)

Requires little force for removal.
When the fitting is removed from the tube, the chuck and collet are released, thus preventing them from biting into the tube excessively.

Tube

Body (White)

O-ring

Stud

Effective when piping in a confined space.
The body and the threaded portion can rotate (For positioning to same extent).

- KQ2
- KQ2-Uni
- KQB2
- KS/KX
- KM
- KF
- M
- H/DL L/LL
- KC
- KK
- KKH
- KK 130
- DM
- DMK
- KDM
- MQR
- KB
- KR-W2
- KRM
- KA
- KQG2
- KG
- KFG2
- MS
- KKA
- KP
- KPQ/KPG
- LQ1
- LQ3
- LQHB

Male connector

KRH-W2

Use to pipe in the same direction from female thread.
Most general style.

Applicable tubing O.D. [mm]	Connection thread	Model
Ø 6	R 1/8	KRH06-01SW2
	R 1/4	KRH06-02SW2
	R 3/8	KRH06-03SW2
Ø 8	R 1/8	KRH08-01SW2
	R 1/4	KRH08-02SW2
	R 3/8	KRH08-03SW2
Ø 10	R 1/8	KRH10-01SW2
	R 1/4	KRH10-02SW2
	R 3/8	KRH10-03SW2
Ø 12	R 1/2	KRH10-04SW2
	R 1/4	KRH12-02SW2
	R 3/8	KRH12-03SW2
	R 1/2	KRH12-04SW2



45° male elbow

KRK-W2

Use to pipe in 45° angle direction from female thread.
Model in-between of male connector and male elbow.

Applicable tubing O.D. [mm]	Connection thread	Model
Ø 6	R 1/8	KRK06-01SW2
	R 1/4	KRK06-02SW2
	R 3/8	KRK06-03SW2
Ø 8	R 1/8	KRK08-01SW2
	R 1/4	KRK08-02SW2
	R 3/8	KRK08-03SW2
Ø 10	R 1/8	KRK10-01SW2
	R 1/4	KRK10-02SW2
	R 3/8	KRK10-03SW2
Ø 12	R 1/2	KRK10-04SW2
	R 1/4	KRK12-02SW2
	R 3/8	KRK12-03SW2
	R 1/2	KRK12-04SW2



Male elbow

KRL-W2

Use to pipe at right angles to female thread.
Most general style.

Applicable tubing O.D. [mm]	Connection thread	Model
Ø 6	R 1/8	KRL06-01SW2
	R 1/4	KRL06-02SW2
	R 3/8	KRL06-03SW2
Ø 8	R 1/8	KRL08-01SW2
	R 1/4	KRL08-02SW2
	R 3/8	KRL08-03SW2
Ø 10	R 1/8	KRL10-01SW2
	R 1/4	KRL10-02SW2
	R 3/8	KRL10-03SW2
Ø 12	R 1/2	KRL10-04SW2
	R 1/4	KRL12-02SW2
	R 3/8	KRL12-03SW2
	R 1/2	KRL12-04SW2



Extended male elbow

KRW-W2

Basically, it is used together with male elbow.
Different point is that it is used for fittings to avoid from interfering with each other by making the piping two-level.

Applicable tubing O.D. [mm]	Connection thread	Model
Ø 6	R 1/8	KRW06-01SW2
	R 1/4	KRW06-02SW2
	R 3/8	KRW06-03SW2
Ø 8	R 1/8	KRW08-01SW2
	R 1/4	KRW08-02SW2
	R 3/8	KRW08-03SW2
Ø 10	R 1/4	KRW10-02SW2
	R 3/8	KRW10-03SW2
	R 1/2	KRW10-04SW2
Ø 12	R 1/4	KRW12-02SW2
	R 3/8	KRW12-03SW2
	R 1/2	KRW12-04SW2



Note) For dimensions and other details refer to specific catalogue of the series at www.smc.eu

Universal male elbow

KRV-W2

Universal male elbow allows thread connection by using a socket wrench for confined spaces.

Applicable tubing O.D. [mm]	Connection thread	Model
Ø 6	R 1/8	KRV06-01SW2
	R 1/4	KRV06-02SW2
Ø 8	R 1/8	KRV08-01SW2
	R 1/4	KRV08-02SW2
	R 3/8	KRV08-03SW2
Ø 10	R 1/4	KRV10-02SW2
	R 3/8	KRV10-03SW2
Ø 12	R 3/8	KRV12-03SW2
	R 1/2	KRV12-04SW2



Male branch tee

KRT-W2

Use to branch line from female thread in both 90° directions.

Applicable tubing O.D. [mm]	Connection thread	Model
Ø 6	R 1/8	KRT06-01SW2
	R 1/4	KRT06-02SW2
	R 3/8	KRT06-03SW2
Ø 8	R 1/8	KRT08-01SW2
	R 1/4	KRT08-02SW2
	R 3/8	KRT08-03SW2
Ø 10	R 1/8	KRT10-01SW2
	R 1/4	KRT10-02SW2
	R 3/8	KRT10-03SW2
Ø 12	R 1/2	KRT10-04SW2
	R 1/4	KRT12-02SW2
	R 3/8	KRT12-03SW2
	R 1/2	KRT12-04SW2



Branch

KRU-W2

Use to branch line in the same direction from female thread.

Applicable tubing O.D. [mm]	Connection thread	Model
Ø 6	R 1/8	KRU06-01SW2
	R 1/4	KRU06-02SW2
	R 3/8	KRU06-03SW2
Ø 8	R 1/8	KRU08-01SW2
	R 1/4	KRU08-02SW2
	R 3/8	KRU08-03SW2
Ø 10	R 1/4	KRU10-02SW2
	R 3/8	KRU10-03SW2
	R 1/2	KRU10-04SW2
Ø 12	R 1/4	KRU12-02SW2
	R 3/8	KRU12-03SW2
	R 1/2	KRU12-04SW2



Male run tee

KRY-W2

Use to branch line in the same direction from female thread and in 90° direction.

Applicable tubing O.D. [mm]	Connection thread	Model
Ø 6	R 1/8	KRY06-01SW2
	R 1/4	KRY06-02SW2
	R 3/8	KRY06-03SW2
Ø 8	R 1/8	KRY08-01SW2
	R 1/4	KRY08-02SW2
	R 3/8	KRY08-03SW2
Ø 10	R 1/8	KRY10-01SW2
	R 1/4	KRY10-02SW2
	R 3/8	KRY10-03SW2
Ø 12	R 1/2	KRY10-04SW2
	R 1/4	KRY12-02SW2
	R 3/8	KRY12-03SW2
	R 1/2	KRY12-04SW2



Straight union

KRH-W2

Use to connect tubes in the same direction.

Applicable tubing O.D. [mm]	Model
Ø 6	KRH06-00W2
Ø 8	KRH08-00W2
Ø 10	KRH10-00W2
Ø 12	KRH12-00W2



Bulkhead union

KRE-W2

Use to connect tubes through a panel.

Applicable tubing O.D. [mm]	Model
Ø 6	KRE06-00W2
Ø 8	KRE08-00W2
Ø 10	KRE10-00W2
Ø 12	KRE12-00W2



Union elbow

KRL-W2

Use to connect tubes at right angles.

Applicable tubing O.D. [mm]	Model
Ø 6	KRL06-00W2
Ø 8	KRL08-00W2
Ø 10	KRL10-00W2
Ø 12	KRL12-00W2



Note) For dimensions and other details refer to specific catalogue of the series at www.smc.eu

- KQ2
- KQ2-Uni
- KQB2
- KS/KX
- KM
- KF
- M
- H/DL L/LL
- KC
- KK
- KKH
- KK 130
- DM
- DMK
- KDM
- MQR
- KB
- KR-W2
- KRM
- KA
- KQG2
- KG
- KFG2
- MS
- KKA
- KP
- KPQ/KPG
- LQ1
- LQ3
- LQHB

Union tee

KRT-W2

Use to connect tubes in both 90° directions.

	Applicable tubing O.D. [mm]	Model
	Ø 6	KRT06-00W2
	Ø 8	KRT08-00W2
	Ø 10	KRT10-00W2
	Ø 12	KRT12-00W2

Union “Y”

KRU-W2

Use to branch line in the same direction.

	Applicable tubing O.D. [mm]	Model
	Ø 6	KRU06-00W2
	Ø 8	KRU08-00W2
	Ø 10	KRU10-00W2
	Ø 12	KRU12-00W2

Plug-in reducer

KRR-W2

Use to size down One-touch fittings.

	Applicable tubing O.D. [mm]	Applicable fitting size	Model
	Ø 6	Ø 8	KRR06-08W2
		Ø 10	KRR06-10W2
	Ø 8	Ø 10	KRR08-10W2
		Ø 12	KRR08-12W2
	Ø 10	Ø 12	KRR10-12W2

Plug-in “Y”

KRU-W2

Use to branch line in the same direction from One-touch fittings.

	Applicable tubing O.D. [mm]	Applicable fitting size	Model
	Ø 6	Ø 6	KRU06-99W2
	Ø 8	Ø 8	KRU08-99W2
	Ø 10	Ø 10	KRU10-99W2
	Ø 12	Ø 12	KRU12-99W2

Note) For dimensions and other details refer to specific catalogue of the series at www.smc.eu

Plug

KRP

Use to plug unused One-touch fittings.

	Applicable fitting size	Model
	Ø 6	KRP-06
	Ø 8	KRP-08
	Ø 10	KRP-10
	Ø 12	KRP-12

* Colour: Green

Spatter cover 1

KR

Prevention of tube releasing unconformity due to an inside intrusion or adhesion of the spatter.

KR (Applicable tube: FR soft nylon)

	Applicable fitting size	Model
	Ø 6	KR-06C
	Ø 8	KR-08C
	Ø 10	KR-10C
	Ø 12	KR-12C

* When tube insert parts are in line as KQU Union “Y”, use KR-□□C1.

* Colour: Grey

Spatter cover 2

KR

Prevention of tube releasing unconformity due to an inside intrusion or adhesion of the spatter.

KR (Applicable tube: FR soft nylon, FR double layer)

	Applicable fitting size	Model
	Ø 6	KR-06C1
	Ø 8	KR-08C1
	Ø 10	KR-10C1
	Ø 12	KR-12C1

* Colour: Grey

Bulkhead connector

KRE-W2

Use to connect male thread and tube through a panel.



Applicable tubing O.D. [mm]	Connection thread	Model
Ø 6	Rc 1/8	KRE06-01W2
	Rc 1/4	KRE06-02W2
	Rc 3/8	KRE06-03W2
Ø 8	Rc 1/8	KRE08-01W2
	Rc 1/4	KRE08-02W2
	Rc 3/8	KRE08-03W2
Ø 10	Rc 1/4	KRE10-02W2
	Rc 3/8	KRE10-03W2
Ø 12	Rc 3/8	KRE12-03W2
	Rc 1/2	KRE12-04W2

Plug-in elbow

KRL-W2

Use to change by 90° in a tube fetching direction from One-touch fittings.



Applicable tubing O.D. [mm]	Applicable tubing O.D. [mm]	Applicable fitting size	Model
Ø 6	Ø 6	Ø 6	KRL06-99W2
Ø 8	Ø 8	Ø 8	KRL08-99W2
Ø 10	Ø 10	Ø 10	KRL10-99W2
Ø 12	Ø 12	Ø 12	KRL12-99W2

Extended plug-in elbow

KRW-W2

Use to change by 90° in a tube fetching direction from One-touch fittings.

Can be used with the plug-in elbow for three-dimensional pipe arrangement.

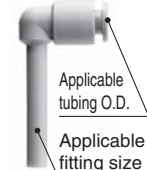

Applicable tubing O.D. [mm]	Applicable tubing O.D. [mm]	Applicable fitting size	Model
Ø 6	Ø 6	Ø 6	KRW06-99W2
Ø 8	Ø 8	Ø 8	KRW08-99W2
Ø 10	Ø 10	Ø 10	KRW10-99W2
Ø 12	Ø 12	Ø 12	KRW12-99W2

Note) For dimensions and other details refer to specific catalogue of the series at www.smc.eu



Made to Order

1 Copper-free (With electroless nickel plated)

Symbol	Specifications
X2	Copper-free (With electroless nickel plated)

Suffix “-X2” to the end of part number.
Example) KRH06-01SW2-X2

- KQ2
- KQ2-Uni
- KQB2
- KS/KX
- KM
- KF
- M
- H/DL L/LL
- KC
- KK
- KKH
- KK 130
- DM
- DMK
- KDM
- MQR
- KB
- KR-W2**
- KRM
- KA
- KQG2
- KG
- KFG2
- MS
- KKA
- KP
- KPQ/KPG
- LQ1
- LQ3
- LQHB

KRM Series

■ Applicable tubing O.D. : **Metric Size**

■ Connection thread : **Rc**

Spatter Proof

Compact piping possible.
Manifold piping possible.
Many varieties (8 types)
are available.
One-touch fittings give the
most efficient operation.
Cover (Option)



Model

Model	Porting		No. of Port A	Port A size	Port B size
	Port A	Port B			
KRM11	One-touch fitting	One-touch fitting	6, 10	Ø 6 tube	Ø 10 tube
				Ø 8 tube	Ø 12 tube
KRM12	One-touch fitting	Rc female thread	6, 10	Ø 6 tube	Rc 1/4
				Ø 8 tube	Rc 3/8

Applicable Tubing

Tubing material	FR double layer, FR soft nylon
Tubing O.D.	Ø 6, Ø 8, Ø 10, Ø 12

Specifications

Model	KRM11	KRM12
Fluid	Air/Water ^{Note)}	
Maximum operating pressure	1 MPa	
Proof pressure	3 MPa	
Ambient and fluid temperature	-5 to 60 °C, Water: 0 to 60 °C (No freezing)	
Thread	—	JIS B0203 (Taper thread for piping)
Accessory	None	Hexagon socket head blank plug with sealant: 1 pc.

Note) The surge pressure must be under the maximum operating pressure.

Construction

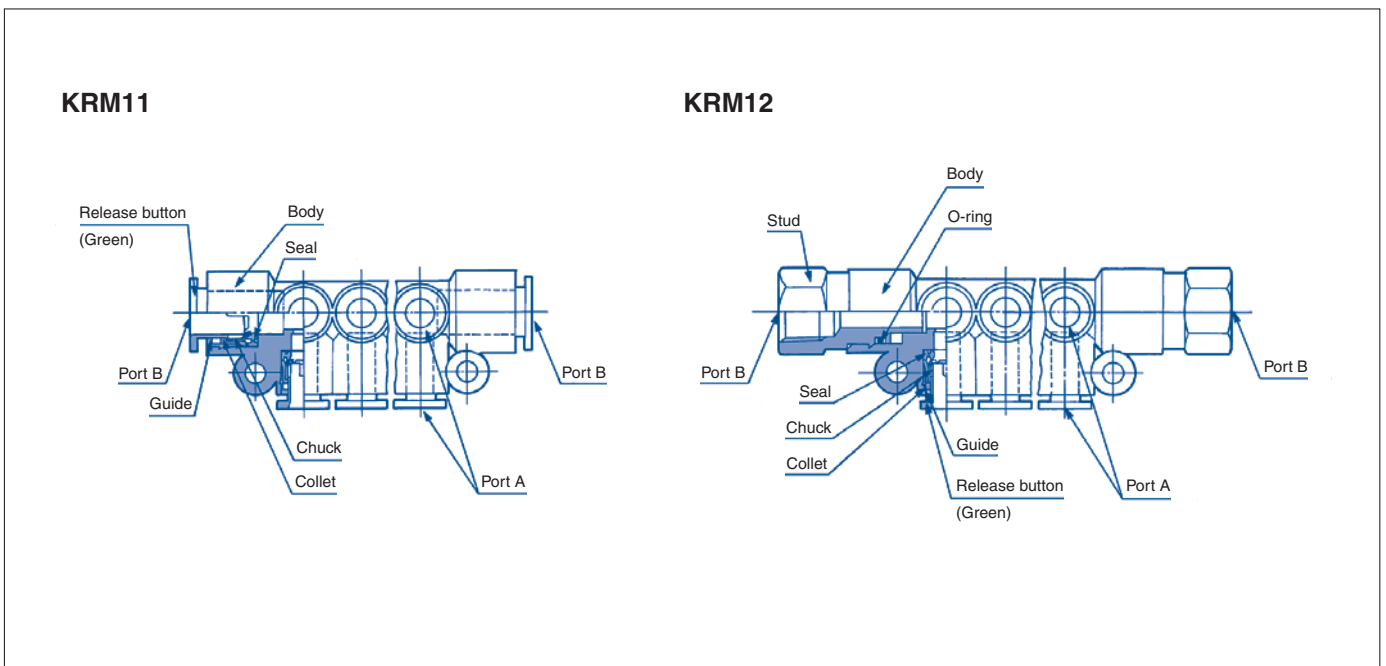

KRM11

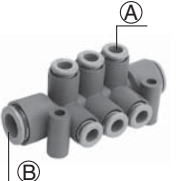

Applicable tubing O.D. [mm]		No. of Port A	Model
(A)	(B)		
Ø 6	Ø 10	6	KRM11-06-10-6
		10	KRM11-06-10-10
Ø 8	Ø 12	6	KRM11-08-12-6
		10	KRM11-08-12-10

KRM12

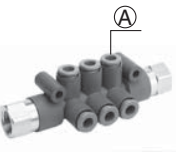

Applicable tubing O.D. (A) [mm]	Connection Thread	No. of Port A	Model
Ø 6	Rc 1/4	6	KRM12-06-02-6
		10	KRM12-06-02-10
Ø 8	Rc 3/8	6	KRM12-08-03-6
		10	KRM12-08-03-10

Spatter cover 3

KRMC

KRMC (Applicable: FR soft nylon)

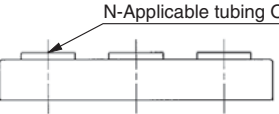

N-Applicable tubing O.D.	Applicable tubing O.D. [mm]	N	Model
Ø 6	Ø 6	6	KRMC-06-6
		10	KRMC-06-10
Ø 8	Ø 8	6	KRMC-08-6
		10	KRMC-08-10

Refer to page 121 for spatter cover 1 and 2.

Note) For dimensions and other details refer to specific catalogue of the series at www.smc.eu

KQ2

KQ2-
Uni

KQB2

KS/
KX

KM

KF

M

H/DL
L/LL

KC

KK

KKH

KK
130

DM

DMK

KDM

MQR

KB

KR
-W2

KRM

KA

KQG2

KG

KFG2

MS

KKA

KP

KPQ/
KPG

LQ1

LQ3

LQHB

Antistatic One-touch Fittings

RoHS

KA Series

■ Applicable tubing O.D. : Metric Size

■ Connection thread : M, Uni Thread

One-touch fittings with antistatic prevention.

One-touch IN/OUT connection.

Possible to use from vacuum (-100 kPa).

Can be used in copper-free application.

Flame resistance (Equivalent to UL-94 standard, material V-0)

Surface resistance 10^4 to $10^7 \Omega$

Conductive resin is used for body and seals in fittings and tubing.

Antistatic Measures

Spatter Proof

Applicable Tubing

Tubing material	Antistatic soft nylon, Antistatic polyurethane
Tubing O.D.	Ø 3.2, Ø 4, Ø 6, Ø 8, Ø 10, Ø 12

Specifications



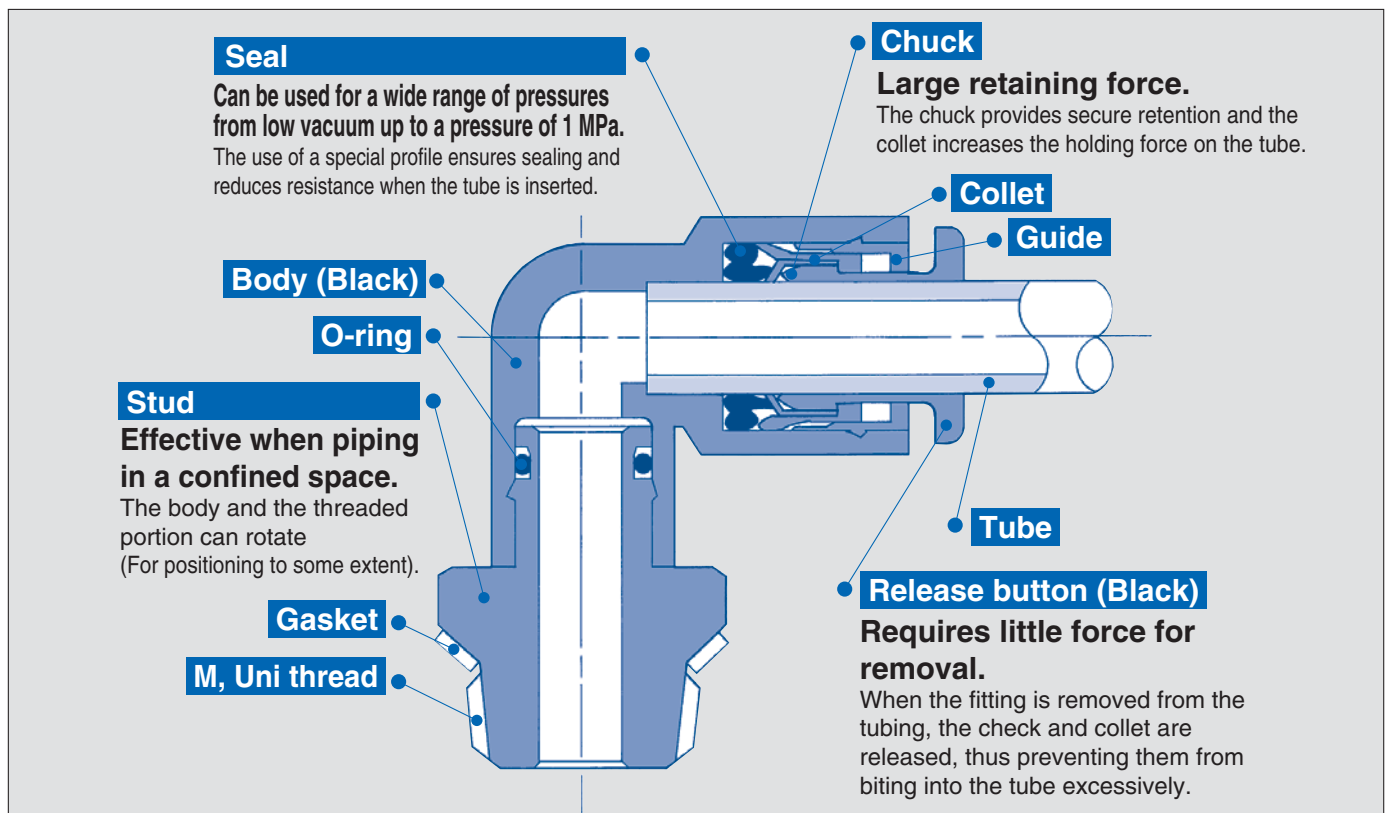



Fluid	Air
Operating pressure range	-100 kPa to 1 MPa
Proof pressure	3 MPa
Ambient and fluid temperature	0 to 40 °C
Thread	Uni thread JIS B0209 (Metric coarse thread)
Seal on the threads	Gasket
Copper-free	Brass parts are all electroless nickel plated.
Surface resistance	10^4 to $10^7 \Omega$



Male connector

KAH





Use to pipe in the same direction from female thread.
Most general style.

	Applicable tubing O.D. [mm]	Connection thread	Model
	Ø 3.2	M5 x 0.8	KAH23-M5
		M6 x 1.0	KAH23-M6
		Uni 1/8	KAH23-U01
	Ø 4	M5 x 0.8	KAH04-M5
		M6 x 1.0	KAH04-M6
		Uni 1/8	KAH04-U01
		Uni 1/4	KAH04-U02
	Ø 6	M5 x 0.8	KAH06-M5
		M6 x 1.0	KAH06-M6
		Uni 1/8	KAH06-U01
		Uni 1/4	KAH06-U02
		Uni 3/8	KAH06-U03
	Ø 8	Uni 1/8	KAH08-U01
		Uni 1/4	KAH08-U02
		Uni 3/8	KAH08-U03
	Ø 10	Uni 1/8	KAH10-U01
		Uni 1/4	KAH10-U02
		Uni 3/8	KAH10-U03
		Uni 1/2	KAH10-U04
	Ø 12	Uni 1/4	KAH12-U02
		Uni 3/8	KAH12-U03
		Uni 1/2	KAH12-U04

Male branch tee

KAT

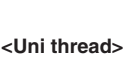
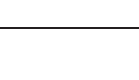
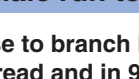



Use to branch line from female thread in both 90° directions.

	Applicable tubing O.D. [mm]	Connection thread	Model
	Ø 3.2	M5 x 0.8	KAT23-M5
		M6 x 1.0	KAT23-M6
		Uni 1/8	KAT23-U01
	Ø 4	M5 x 0.8	KAT04-M5
		M6 x 1.0	KAT04-M6
		Uni 1/8	KAT04-U01
		Uni 1/4	KAT04-U02
	Ø 6	M5 x 0.8	KAT06-M5
		M6 x 1.0	KAT06-M6
		Uni 1/8	KAT06-U01
		Uni 1/4	KAT06-U02
		Uni 3/8	KAT06-U03
	Ø 8	Uni 1/8	KAT08-U01
		Uni 1/4	KAT08-U02
		Uni 3/8	KAT08-U03
	Ø 10	Uni 1/8	KAT10-U01
		Uni 1/4	KAT10-U02
		Uni 3/8	KAT10-U03
		Uni 1/2	KAT10-U04
	Ø 12	Uni 1/4	KAT12-U02
		Uni 3/8	KAT12-U03
		Uni 1/2	KAT12-U04

Male elbow

KAL

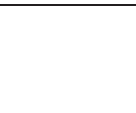



Use to pipe at right angles to female thread.
Most general style.

	Applicable tubing O.D. [mm]	Connection thread	Model
	Ø 3.2	M5 x 0.8	KAL23-M5
		M6 x 1.0	KAL23-M6
		Uni 1/8	KAL23-U01
	Ø 4	M5 x 0.8	KAL04-M5
		M6 x 1.0	KAL04-M6
		Uni 1/8	KAL04-U01
		Uni 1/4	KAL04-U02
	Ø 6	M5 x 0.8	KAL06-M5
		M6 x 1.0	KAL06-M6
		Uni 1/8	KAL06-U01
		Uni 1/4	KAL06-U02
		Uni 3/8	KAL06-U03
	Ø 8	Uni 1/8	KAL08-U01
		Uni 1/4	KAL08-U02
		Uni 3/8	KAL08-U03
	Ø 10	Uni 1/8	KAL10-U01
		Uni 1/4	KAL10-U02
		Uni 3/8	KAL10-U03
		Uni 1/2	KAL10-U04
	Ø 12	Uni 1/4	KAL12-U02
		Uni 3/8	KAL12-U03
		Uni 1/2	KAL12-U04

Male run tee

KAY

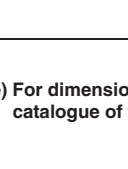
Use to branch line in the same direction from female thread and in 90° direction.

	Applicable tubing O.D. [mm]	Connection thread	Model
	Ø 3.2	M5 x 0.8	KAY23-M5
		M6 x 1.0	KAY23-M6
		Uni 1/8	KAY23-U01
	Ø 4	M5 x 0.8	KAY04-M5
		M6 x 1.0	KAY04-M6
		Uni 1/8	KAY04-U01
		Uni 1/4	KAY04-U02
	Ø 6	M5 x 0.8	KAY06-M5
		M6 x 1.0	KAY06-M6
		Uni 1/8	KAY06-U01
		Uni 1/4	KAY06-U02
		Uni 3/8	KAY06-U03
	Ø 8	Uni 1/8	KAY08-U01
		Uni 1/4	KAY08-U02
		Uni 3/8	KAY08-U03
	Ø 10	Uni 1/8	KAY10-U01
		Uni 1/4	KAY10-U02
		Uni 3/8	KAY10-U03
		Uni 1/2	KAY10-U04
	Ø 12	Uni 1/4	KAY12-U02
		Uni 3/8	KAY12-U03
		Uni 1/2	KAY12-U04

Note) For dimensions and other details refer to specific catalogue of the series at www.smc.eu

- KQ2
- KQ2-Uni
- KQB2
- KS/KX
- KM
- KF
- M
- H/DL L/LL
- KC
- KK
- KKH
- KK 130
- DM
- DMK
- KDM
- MQR
- KB
- KR-W2
- KRM
- KA
- KQG2
- KG
- KFG2
- MS
- KKA
- KP
- KPQ/KPG
- LQ1
- LQ3
- LQHB

Branch **KAU**

Use to branch line in the same direction from female thread.

Applicable tubing O.D. [mm]	Connection thread	Model
Ø 3.2	M5 x 0.8	KAU23-M5
	M6 x 1.0	KAU23-M6
	Uni 1/8	KAU23-U01
Ø 4	M5 x 0.8	KAU04-M5
	M6 x 1.0	KAU04-M6
	Uni 1/8	KAU04-U01
	Uni 1/4	KAU04-U02
Ø 6	M5 x 0.8	KAU06-M5
	M6 x 1.0	KAU06-M6
	Uni 1/8	KAU06-U01
	Uni 1/4	KAU06-U02
	Uni 3/8	KAU06-U03
Ø 8	Uni 1/8	KAU08-U01
	Uni 1/4	KAU08-U02
	Uni 3/8	KAU08-U03
Ø 10	Uni 1/4	KAU10-U02
	Uni 3/8	KAU10-U03
	Uni 1/2	KAU10-U04
Ø 12	Uni 1/4	KAU12-U02
	Uni 3/8	KAU12-U03
	Uni 1/2	KAU12-U04

<M5, M6>

<Uni thread>

Union tee **KAT**

Use to connect tubes in both 90° directions.

Applicable tubing O.D. [mm]	Model
	
Ø 3.2	KAT23-00
Ø 4	KAT04-00
Ø 6	KAT06-00
Ø 8	KAT08-00
Ø 10	KAT10-00
Ø 12	KAT12-00

Union "Y" **KAU**

Use to branch line in the same direction.

Applicable tubing O.D. [mm]	Model
	
Ø 3.2	KAU23-00
Ø 4	KAU04-00
Ø 6	KAU06-00
Ø 8	KAU08-00
Ø 10	KAU10-00
Ø 12	KAU12-00

Straight union **KAH**

Use to connect tubes in the same direction.

Applicable tubing O.D. [mm]	Model
	
Ø 3.2	KAH23-00
Ø 4	KAH04-00
Ø 6	KAH06-00
Ø 8	KAH08-00
Ø 10	KAH10-00
Ø 12	KAH12-00

Different diameter straight **KAH**

Use to connect tubing of different sizes.

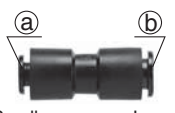
Applicable tubing O.D. [mm]	Model	
	(a)	(b)
		
Ø 3.2	Ø 4	KAH23-04
Ø 4	Ø 6	KAH04-06
Ø 6	Ø 8	KAH06-08
Ø 8	Ø 10	KAH08-10
Ø 10	Ø 12	KAH10-12

Union elbow **KAL**

Use to connect tubes at right angles.

Applicable tubing O.D. [mm]	Model
	
Ø 3.2	KAL23-00
Ø 4	KAL04-00
Ø 6	KAL06-00
Ø 8	KAL08-00
Ø 10	KAL10-00
Ø 12	KAL12-00

Plug-in reducer **KAR**

Use to size down One-touch fittings.

Applicable tubing O.D. [mm]	Applicable tubing O.D. [mm]	Applicable fitting size	Model
			
Ø 3.2	Ø 4	Ø 4	KAR23-04
		Ø 6	KAR04-06
		Ø 8	KAR04-08
Ø 4	Ø 6	Ø 8	KAR04-08
		Ø 10	KAR04-10
		Ø 8	KAR06-08
Ø 6	Ø 8	Ø 10	KAR06-10
		Ø 12	KAR06-12
		Ø 10	KAR08-10
Ø 8	Ø 10	Ø 12	KAR08-12
		Ø 12	KAR10-12

Note) For dimensions and other details refer to specific catalogue of the series at www.smc.eu

Stainless Steel 316 One-touch Fittings RoHS

KQG2 Series

■ Applicable tubing O.D. : Metric Size

■ Connection thread : M5, R, Rc

Corrosion Resistant

Heat Resistant

Material/

Metal parts: **Stainless steel 316**

Seal parts: Special **FKM**

Can be used with steam.

Fluid temperature: -5 to 150 °C

Grease-free



Applicable Tubing

Tubing material	FEP, PFA, Nylon, Soft nylon, Polyurethane, Polyolefin
Tubing O.D.	Ø 3.2, Ø 4, Ø 6, Ø 8, Ø 10, Ø 12, Ø 16

Specifications

Fluid	Air, Water, Steam ^{Note 1)}
Operating pressure range ^{Note 2)}	-100 kPa to 1 MPa ^{Note 3)}
Proof pressure	3.0 MPa
Ambient and fluid temperature ^{Note 4)}	-5 to 150 °C (No freezing) ^{Note 3)}
Lubricant	Grease-free specification
Seal on the threads	With sealant

Note 1) Consult with SMC regarding applicable tube separately.

Note 2) Avoid using in a vacuum holding application such as a leak tester, since there is leakage.

Note 3) Check the operating pressure range and operating temperature range of the tubing.

Note 4) It is recommended that you use the inner sleeve in the following conditions (Except Ø 3.2)

- When using in an environment where the fluid temperature changes drastically.
- When using at a high temperature.

* Temperature Condition of Mounting the Inner Sleeve

Tubing	Temperature
FEP tubing/Series TH	80 °C or more
PFA tubing/Series TL	120 °C or more

Cross Reference Table of the Inner Sleeve

Tubing O.D.	Tubing material			Applicable inner sleeve	
	TUS (Soft polyurethane)	TH/TH (FEP)	TL/TIL (PFA)	Part no.	Length
Ø 4	—	TH0402	—	TJG-0402	18
	TUS0425	TH0425	—	TJG-0425	18
	—	—	TL0403	TJG-0403	18
Ø 6	TUS0604	TH0604	TL0604	TJG-0604	19
	—	—	—	TJG-0805	20.5
Ø 8	TUS0805	—	—	TJG-0805	20.5
	—	TH0806	TL0806	TJG-0806	20.5
Ø 10	TUS1065	—	—	TJG-1065	23
	—	TH1075	—	TJG-1075	23
	—	TH1008	TL1008	TJG-1008	23
Ø 12	TUS1208	—	—	TJG-1208	24
	—	TH1209	—	TJG-1209	24
	—	TH1210	TL1210	TJG-1210	24

* Stainless steel 316 is used for the TJG series.

All Stainless steel 316
except seal parts

Male connector

Seal parts
(Special FKM)

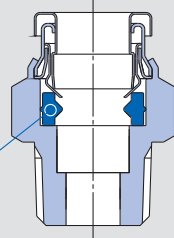

Male elbow

Seal parts
(Special FKM)

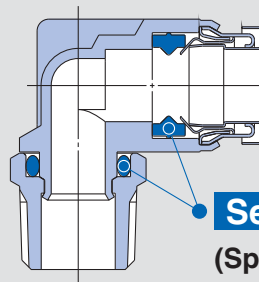

For inch size, refer to the **WEB catalogue** at www.smc.eu

Male connector

KQG2H

Applicable tubing O.D. [mm]	Connection thread	Model
Ø 3.2	M5 x 0.8	KQG2H23-M5
	R 1/8	KQG2H23-01S
	R 1/4	KQG2H23-02S
Ø 4	M5 x 0.8	KQG2H04-M5
	R 1/8	KQG2H04-01S
	R 1/4	KQG2H04-02S
Ø 6	M5 x 0.8	KQG2H06-M5
	R 1/8	KQG2H06-01S
	R 1/4	KQG2H06-02S
	R 3/8	KQG2H06-03S
Ø 8	R 1/8	KQG2H08-01S
	R 1/4	KQG2H08-02S
	R 3/8	KQG2H08-03S
Ø 10	R 1/8	KQG2H10-01S
	R 1/4	KQG2H10-02S
	R 3/8	KQG2H10-03S
Ø 12	R 1/4	KQG2H12-02S
	R 3/8	KQG2H12-03S
Ø 16	R 3/8	KQG2H16-03S
	R 1/2	KQG2H16-04S



Straight union

KQG2H

Applicable tubing O.D. [mm]	Model
Ø 3.2	KQG2H23-00
Ø 4	KQG2H04-00
Ø 6	KQG2H06-00
Ø 8	KQG2H08-00
Ø 10	KQG2H10-00
Ø 12	KQG2H12-00
Ø 16	KQG2H16-00



Male elbow

KQG2L

Applicable tubing O.D. [mm]	Connection thread	Model
Ø 3.2	M5 x 0.8	KQG2L23-M5
	R 1/8	KQG2L23-01S
	R 1/4	KQG2L23-02S
Ø 4	M5 x 0.8	KQG2L04-M5
	R 1/8	KQG2L04-01S
	R 1/4	KQG2L04-02S
Ø 6	M5 x 0.8	KQG2L06-M5
	R 1/8	KQG2L06-01S
	R 1/4	KQG2L06-02S
	R 3/8	KQG2L06-03S
Ø 8	R 1/8	KQG2L08-01S
	R 1/4	KQG2L08-02S
	R 3/8	KQG2L08-03S
Ø 10	R 1/8	KQG2L10-01S
	R 1/4	KQG2L10-02S
	R 3/8	KQG2L10-03S
Ø 12	R 1/4	KQG2L12-02S
	R 3/8	KQG2L12-03S
	R 1/2	KQG2L12-04S
Ø 16	R 3/8	KQG2L16-03S
	R 1/2	KQG2L16-04S



Hexagon socket head male connector

KQG2S

Applicable tubing O.D. [mm]	Connection thread	Model
Ø 3.2	M5 x 0.8	KQG2S23-M5
Ø 4	M5 x 0.8	KQG2S04-M5
	R 1/8	KQG2S04-01S
Ø 6	M5 x 0.8	KQG2S06-M5
	R 1/8	KQG2S06-01S
	R 1/4	KQG2S06-02S
Ø 8	R 1/8	KQG2S08-01S
	R 1/4	KQG2S08-02S
	R 3/8	KQG2S08-03S
Ø 10	R 1/8	KQG2S10-01S
	R 1/4	KQG2S10-02S
	R 3/8	KQG2S10-03S
	R 1/2	KQG2S10-04S
Ø 12	R 1/4	KQG2S12-02S
	R 3/8	KQG2S12-03S
	R 1/2	KQG2S12-04S
Ø 16	R 3/8	KQG2S16-03S
	R 1/2	KQG2S16-04S



Note) For dimensions and other details refer to specific catalogue of the series at www.smc.eu

Male branch tee

KQG2T



Applicable tubing O.D. [mm]	Connection thread	Model
Ø 3.2	M5 x 0.8	KQG2T23-M5
	R 1/8	KQG2T23-01S
	R 1/4	KQG2T23-02S
Ø 4	M5 x 0.8	KQG2T04-M5
	R 1/8	KQG2T04-01S
	R 1/4	KQG2T04-02S
Ø 6	M5 x 0.8	KQG2T06-M5
	R 1/8	KQG2T06-01S
	R 1/4	KQG2T06-02S
	R 3/8	KQG2T06-03S
Ø 8	R 1/8	KQG2T08-01S
	R 1/4	KQG2T08-02S
	R 3/8	KQG2T08-03S
Ø 10	R 1/8	KQG2T10-01S
	R 1/4	KQG2T10-02S
	R 3/8	KQG2T10-03S
Ø 12	R 1/2	KQG2T10-04S
	R 1/4	KQG2T12-02S
	R 3/8	KQG2T12-03S
Ø 16	R 1/2	KQG2T12-04S
	R 3/8	KQG2T16-03S
	R 1/2	KQG2T16-04S

Union tee

KQG2T



Applicable tubing O.D. [mm]	Model
Ø 3.2	KQG2T23-00
Ø 4	KQG2T04-00
Ø 6	KQG2T06-00
Ø 8	KQG2T08-00
Ø 10	KQG2T10-00
Ø 12	KQG2T12-00
Ø 16	KQG2T16-00

Union "Y"

KQG2U



Applicable tubing O.D. [mm]	Model
Ø 3.2	KQG2U23-00
Ø 4	KQG2U04-00
Ø 6	KQG2U06-00
Ø 8	KQG2U08-00
Ø 10	KQG2U10-00
Ø 12	KQG2U12-00
Ø 16	KQG2U16-00

Union elbow

KQG2L



Applicable tubing O.D. [mm]	Model
Ø 3.2	KQG2L23-00
Ø 4	KQG2L04-00
Ø 6	KQG2L06-00
Ø 8	KQG2L08-00
Ø 10	KQG2L10-00
Ø 12	KQG2L12-00
Ø 16	KQG2L16-00

Different diameter tee

KQG2T

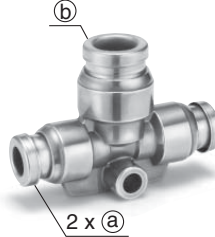

Applicable tubing O.D. mm	Model	
	①	②
Ø 3.2	Ø 4	KQG2T23-04
Ø 4	Ø 6	KQG2T04-06
Ø 6	Ø 8	KQG2T06-08
Ø 8	Ø 10	KQG2T08-10
Ø 10	Ø 12	KQG2T10-12
Ø 12	Ø 16	KQG2T12-16

Bulkhead union

KQG2E



Applicable tubing O.D. [mm]	Model
Ø 3.2	KQG2E23-00
Ø 4	KQG2E04-00
Ø 6	KQG2E06-00
Ø 8	KQG2E08-00
Ø 10	KQG2E10-00
Ø 12	KQG2E12-00
Ø 16	KQG2E16-00

Plug-in reducer

KQG2R



Applicable tubing O.D. [mm]	Applicable fitting size Ø d	Model
Ø 3.2	Ø 4	KQG2R23-04
Ø 4	Ø 6	KQG2R04-06
Ø 6	Ø 8	KQG2R06-08
Ø 8	Ø 10	KQG2R08-10
Ø 10	Ø 12	KQG2R10-12
Ø 12	Ø 16	KQG2R12-16

Note) For dimensions and other details refer to specific catalogue of the series at www.smc.eu

- KQ2
- KQ2-Uni
- KQB2
- KS/KX
- KM
- KF
- M
- H/DL L/L
- KC
- KK
- KKH
- KK 130
- DM
- DMK
- KDM
- MQR
- KB
- KR-W2
- KRM
- KA
- KQG2
- KG
- KFG2
- MS
- KKA
- KP
- KPQ/KPG
- LQ1
- LQ3
- LQHB

Different diameter straight

KQG2H



Applicable tubing O.D. [mm]		Model
(a)	(b)	
Ø 3.2	Ø 4	KQG2H23-04
Ø 4	Ø 6	KQG2H04-06
Ø 6	Ø 8	KQG2H06-08
Ø 8	Ø 10	KQG2H08-10
Ø 10	Ø 12	KQG2H10-12
Ø 12	Ø 16	KQG2H12-16

Different diameter union "Y"

KQG2U



Applicable tubing O.D. [mm]		Model
(a)	(b)	
Ø 3.2	Ø 4	KQG2U23-04
Ø 4	Ø 6	KQG2U04-06
Ø 6	Ø 8	KQG2U06-08
Ø 8	Ø 10	KQG2U08-10
Ø 10	Ø 12	KQG2U10-12
Ø 12	Ø 16	KQG2U12-16

Bulkhead connector

KQG2E



Applicable tubing O.D. [mm]	Connection thread	Model
Ø 3.2	Rc 1/4	KQG2E23-02
Ø 4	Rc 1/8	KQG2E04-01
	Rc 1/4	KQG2E04-02
Ø 6	Rc 1/8	KQG2E06-01
	Rc 1/4	KQG2E06-02
	Rc 3/8	KQG2E06-03
Ø 8	Rc 1/8	KQG2E08-01
	Rc 1/4	KQG2E08-02
	Rc 3/8	KQG2E08-03
Ø 10	Rc 1/4	KQG2E10-02
	Rc 3/8	KQG2E10-03
Ø 12	Rc 3/8	KQG2E12-03
	Rc 1/2	KQG2E12-04
Ø 16	Rc 3/8	KQG2E16-03
	Rc 1/2	KQG2E16-04

Extended male elbow

KQG2W



Applicable tubing O.D. [mm]	Connection thread	Model
Ø 3.2	M5 x 0.8	KQG2W23-M5
	R 1/8	KQG2W23-01S
	R 1/4	KQG2W23-02S
Ø 4	M5 x 0.8	KQG2W04-M5
	R 1/8	KQG2W04-01S
	R 1/4	KQG2W04-02S
Ø 6	M5 x 0.8	KQG2W06-M5
	R 1/8	KQG2W06-01S
	R 1/4	KQG2W06-02S
	R 3/8	KQG2W06-03S
Ø 8	R 1/8	KQG2W08-01S
	R 1/4	KQG2W08-02S
	R 3/8	KQG2W08-03S
Ø 10	R 1/4	KQG2W10-02S
	R 3/8	KQG2W10-03S
Ø 12	R 1/2	KQG2W10-04S
	R 1/4	KQG2W12-02S
	R 3/8	KQG2W12-03S
Ø 16	R 1/2	KQG2W12-04S
	R 3/8	KQG2W16-03S
	R 1/2	KQG2W16-04S

Female connector

KQG2F



Applicable tubing O.D. [mm]	Connection thread	Model
Ø 3.2	Rc 1/8	KQG2F23-01
Ø 4	Rc 1/8	KQG2F04-01
	Rc 1/4	KQG2F04-02
Ø 6	Rc 1/8	KQG2F06-01
	Rc 1/4	KQG2F06-02
	Rc 3/8	KQG2F06-03
Ø 8	Rc 1/8	KQG2F08-01
	Rc 1/4	KQG2F08-02
	Rc 3/8	KQG2F08-03
Ø 10	Rc 1/4	KQG2F10-02
	Rc 3/8	KQG2F10-03
Ø 12	Rc 1/4	KQG2F12-02
	Rc 3/8	KQG2F12-03
Ø 16	Rc 1/2	KQG2F12-04
	Rc 3/8	KQG2F16-03
	Rc 1/2	KQG2F16-04

Note) For dimensions and other details refer to specific catalogue of the series at www.smc.eu

Plug

KQG2P



Applicable fitting size Ø d	Model
Ø 3.2	KQG2P-23
Ø 4	KQG2P-04
Ø 6	KQG2P-06
Ø 8	KQG2P-08
Ø 10	KQG2P-10
Ø 12	KQG2P-12
Ø 16	KQG2P-16

Spare Parts

Description	Tubing O.D.	Part no.	Material
Gasket	—	M-5G3	Stainless steel 316, Special FKM
Bulkhead nut	Ø 3.2	KQG223-P01	Stainless steel 316
	Ø 4		
	Ø 6	KQG206-P01	
	Ø 8	KQG208-P01	
	Ø 10	KQG210-P01	
	Ø 12	KQG212-P01	
	Ø 16	KQG216-P01	

Note) For dimensions and other details refer to specific catalogue of the series at www.smc.eu

Stainless Steel One-touch Fittings

RoHS

KG Series

■ Applicable tubing O.D. : Metric Size

■ Connection thread : M5, R, Rc

Corrosion Resistant

Stainless steel specifications applicable to corrosive environments
Stainless steel 303 adopted for metal elements

Suitable for use in CRT production lines where contact with copper must be avoided, food processing machines where water or salt water splashes and clean room where discolouration of copper material and corrosion must be avoided.



Applicable Tubing

Tubing material	FEP, PFA, Nylon, Soft nylon, Polyurethane
Tubing O.D.	Ø 4, Ø 6, Ø 8, Ø 10, Ø 12, Ø 16

Specifications

Fluid		Air/Water ^{Note 1)}
Operating pressure range ^{Note 2)}		-100 kPa to 1 MPa
Proof pressure		3 MPa
Ambient and fluid temperature		-5 to 60 °C, Water: 0 to 40 °C (No freezing)
Thread	Mounting section	JIS B0203 (Taper thread for piping) JIS B0205 (Metric coarse thread)
	Nut section	JIS B0205 (Metric fine thread)
Seal on the threads		With sealant ^{Note 3)} or none

Note 1) The surge pressure must be under the maximum operating pressure.

Note 2) Do not use the fittings with a leak tester or for vacuum retention because they are not guaranteed for zero leakage.

Note 3) Suffix "S" to the part number, if w/ seal is desired.

Guide

Collet

Chuck

Suitable for use with nylon and urethane.

Large retaining force.

The chuck provides secure retention and the collet increases the holding force on the tube.

Seal

Can be used for a wide range of pressures from a low vacuum up to a pressure of 1 MPa.

The use of a special profile ensures sealing and reduces resistance when the tube is inserted.

Release button (White)

Requires little force for removal.

When the fitting is removed from the tubing, the chuck and collet are released, thus preventing them from biting into the tube excessively.

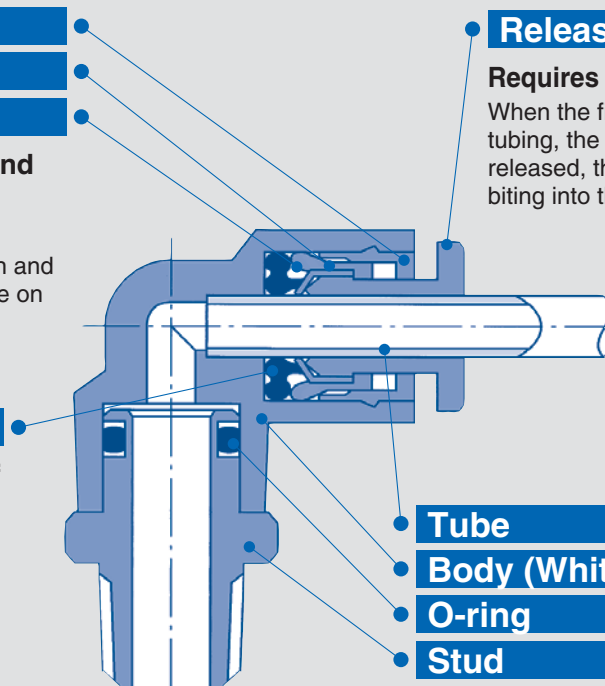

Tube

Body (White)

O-ring

Stud

Effective when piping in a confined space.
The body and the threaded portion can rotate.

Male connector

KGH

Use to pipe in the same direction from female thread.
Most general style.

	Applicable tubing O.D. [mm]	Connection thread	Model
	Ø 4	M5 x 0.8	KGH04-M5
		R 1/8	KGH04-01
		R 1/4	KGH04-02
	Ø 6	M5 x 0.8	KGH06-M5
		R 1/8	KGH06-01
		R 1/4	KGH06-02
		R 3/8	KGH06-03
Ø 8	R 1/8	KGH08-01	
	R 1/4	KGH08-02	
	R 3/8	KGH08-03	
Ø 10	R 1/8	KGH10-01	
	R 1/4	KGH10-02	
	R 3/8	KGH10-03	
	R 1/2	KGH10-04	
Ø 12	R 1/4	KGH12-02	
	R 3/8	KGH12-03	
	R 1/2	KGH12-04	
Ø 16	R 3/8	KGH16-03	
	R 1/2	KGH16-04	

Male elbow

KGL

Use to pipe at right angles to female thread.
Most general style.

	Applicable tubing O.D. [mm]	Connection thread	Model
	Ø 4	M5 x 0.8	KGL04-M5
		R 1/8	KGL04-01
		R 1/4	KGL04-02
	Ø 6	M5 x 0.8	KGL06-M5
		R 1/8	KGL06-01
		R 1/4	KGL06-02
		R 3/8	KGL06-03
Ø 8	R 1/8	KGL08-01	
	R 1/4	KGL08-02	
	R 3/8	KGL08-03	
Ø 10	R 1/8	KGL10-01	
	R 1/4	KGL10-02	
	R 3/8	KGL10-03	
	R 1/2	KGL10-04	
Ø 12	R 1/4	KGL12-02	
	R 3/8	KGL12-03	
	R 1/2	KGL12-04	
Ø 16	R 3/8	KGL16-03	
	R 1/2	KGL16-04	

Hexagon socket head male connector

KGS

Internal hex. allows thread connection by using an allen wrench for confined spaces.

	Applicable tubing O.D. [mm]	Connection thread	Model
	Ø 4	M5 x 0.8	KGS04-M5
		R 1/8	KGS04-01
	Ø 6	M5 x 0.8	KGS06-M5
		R 1/8	KGS06-01
		R 1/4	KGS06-02
Ø 8	R 1/8	KGS08-01	
	R 3/8	KGS08-03	
Ø 10	R 1/8	KGS10-01	
	R 1/4	KGS10-02	
	R 3/8	KGS10-03	
	R 1/2	KGS10-04	
Ø 12	R 1/4	KGS12-02	
	R 3/8	KGS12-03	
	R 1/2	KGS12-04	

Extended male elbow

KGW

Basically, it is used together with male elbow.
Different point is that it is used for fittings to avoid from interfering with each other by making the piping two-level.

	Applicable tubing O.D. [mm]	Connection thread	Model
	Ø 4	M5 x 0.8	KGW04-M5
		R 1/8	KGW04-01
		R 1/4	KGW04-02
Ø 6	Ø 6	M5 x 0.8	KGW06-M5
		R 1/8	KGW06-01
		R 3/8	KGW06-03
Ø 8	Ø 8	R 1/8	KGW08-01
		R 1/4	KGW08-02
		R 3/8	KGW08-03
Ø 10	Ø 10	R 1/4	KGW10-02
		R 3/8	KGW10-03
		R 1/2	KGW10-04
		R 1/4	KGW12-02
Ø 12	Ø 12	R 3/8	KGW12-03
		R 1/2	KGW12-04

Note) For dimensions and other details refer to specific catalogue of the series at www.smc.eu

Universal male elbow

KGV

Universal male elbow allows thread connection by using a socket wrench for confined spaces.

Applicable tubing O.D. [mm]	Connection thread	Model	
			
Ø 6	M5 x 0.8	KGV06-M5	
	R 1/8	KGV06-01	
Ø 8	R 1/4	KGV06-02	
	R 1/8	KGV08-01	
Ø 10	R 1/4	KGV08-02	
	R 3/8	KGV08-03	
Ø 12	R 3/8	KGV10-02	
	R 1/2	KGV10-03	
		KGV12-03	
		KGV12-04	

Male run tee

KGY

Use to branch line in the same direction from female thread and in 90° direction.

Applicable tubing O.D. [mm]	Connection thread	Model	
			
Ø 6	M5 x 0.8	KGY06-M5	
	R 1/8	KGY06-01	
	R 1/4	KGY06-02	
Ø 8	R 3/8	KGY06-03	
	R 1/8	KGY08-01	
	R 1/4	KGY08-02	
Ø 10	R 3/8	KGY08-03	
	R 1/8	KGY10-01	
	R 1/4	KGY10-02	
Ø 12	R 3/8	KGY10-03	
	R 1/2	KGY10-04	
	R 1/4	KGY12-02	
Ø 16	R 3/8	KGY12-03	
	R 1/2	KGY12-04	
	R 3/8	KGY16-03	
		KGY16-04	

Male branch tee

KGT

Use to branch line from female thread in both 90° directions.

Applicable tubing O.D. [mm]	Connection thread	Model	
			
Ø 6	M5 x 0.8	KGT06-M5	
	R 1/8	KGT06-01	
	R 1/4	KGT06-02	
Ø 8	R 3/8	KGT06-03	
	R 1/8	KGT08-01	
	R 1/4	KGT08-02	
Ø 10	R 3/8	KGT08-03	
	R 1/8	KGT10-01	
	R 1/4	KGT10-02	
Ø 12	R 3/8	KGT10-03	
	R 1/2	KGT10-04	
	R 1/4	KGT12-02	
Ø 16	R 3/8	KGT12-03	
	R 1/2	KGT12-04	
	R 3/8	KGT16-03	
		KGT16-04	

Branch

KGU



Use to branch line in the same direction from female thread.

Applicable tubing O.D. [mm]	Connection thread	Model	
			
Ø 6	M5 x 0.8	KGU06-M5	
	R 1/8	KGU06-01	
	R 1/4	KGU06-02	
Ø 8	R 3/8	KGU06-03	
	R 1/8	KGU08-01	
	R 1/4	KGU08-02	
Ø 10	R 3/8	KGU08-03	
	R 1/4	KGU10-02	
	R 3/8	KGU10-03	
Ø 12	R 1/2	KGU10-04	
	R 1/4	KGU12-02	
	R 3/8	KGU12-03	
		KGU12-04	

Note) For dimensions and other details refer to specific catalogue of the series at www.smc.com



Male branch connector **KGLU**

Use to branch line at right angles to female thread.

	Applicable tubing O.D. [mm]	Connection thread	Model
	Ø 4	M5 x 0.8	KGLU04-M5
		R 1/8	KGLU04-01
		R 1/4	KGLU04-02
	Ø 6	M5 x 0.8	KGLU06-M5
		R 1/8	KGLU06-01
		R 1/4	KGLU06-02
		R 3/8	KGLU06-03
	Ø 8	R 1/8	KGLU08-01
		R 1/4	KGLU08-02
		R 3/8	KGLU08-03
	Ø 10	R 1/4	KGLU10-02
		R 3/8	KGLU10-03
		R 1/2	KGLU10-04
	Ø 12	R 1/4	KGLU12-02
		R 3/8	KGLU12-03
		R 1/2	KGLU12-04

Male delta union **KGD**

Use to branch line in 90° direction from female thread.

	Applicable tubing O.D. [mm]	Connection thread	Model
	Ø 4	M5 x 0.8	KGD04-M5
		R 1/8	KGD04-01
		R 1/4	KGD04-02
	Ø 6	M5 x 0.8	KGD06-M5
		R 1/8	KGD06-01
		R 1/4	KGD06-02
		R 3/8	KGD06-03
	Ø 8	R 1/8	KGD08-01
		R 1/4	KGD08-02
		R 3/8	KGD08-03
	Ø 10	R 1/4	KGD10-02
		R 3/8	KGD10-03
		R 1/2	KGD10-04
	Ø 12	R 1/4	KGD12-02
		R 3/8	KGD12-03
		R 1/2	KGD12-04

Double branch **KGUD**

Use to four-branch line in the same direction from female thread.

	Applicable tubing O.D. [mm]	Connection thread	Model
	Ø 4	R 1/8	KGUD04-01
		R 1/4	KGUD04-02
	Ø 6	R 1/8	KGUD06-01
		R 1/4	KGUD06-02

Straight union **KGH**

Use to connect tubes in the same direction.

	Applicable tubing O.D. [mm]	Model
	Ø 4	KGH04-00
	Ø 6	KGH06-00
	Ø 8	KGH08-00
	Ø 10	KGH10-00
	Ø 12	KGH12-00

Bulkhead union **KGE**

Use to connect tubes through a panel.

	Applicable tubing O.D. [mm]	Model
	Ø 4	KGE04-00
	Ø 6	KGE06-00
	Ø 8	KGE08-00
	Ø 10	KGE10-00
	Ø 12	KGE12-00
	Ø 16	KGE16-00

Note) For dimensions and other details refer to specific catalogue of the series at www.smc.eu

KQ2

KQ2-Uni

KQB2

KS/KX

KM

KF

M

H/DL
L/LL

KC

KK

KKH

KK
130

DM

DMK

KDM

MQR

KB

KR
-W2

KRM

KA

KQG2

KG

KFG2

MS

KKA

KP

KPQ/
KPG

LQ1

LQ3

LQHB

Union elbow

KGL

Use to connect tubes at right angles.

	Applicable tubing O.D. [mm]		Model
	(a)	(b)	
	Ø 4	Ø 6	KGL04-00
	Ø 6	Ø 8	KGL06-00
	Ø 8	Ø 10	KGL08-00
	Ø 10	Ø 12	KGL10-00
	Ø 12	Ø 16	KGL12-00
	Ø 16	Ø 20	KGL16-00

Different diameter tee

KGT

Use to connect tubes with size down in both 90° directions.

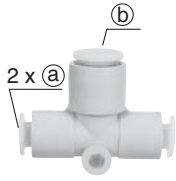
	Applicable tubing O.D. [mm]		Model
	(a)	(b)	
	Ø 4	Ø 6	KGT04-06
	Ø 6	Ø 8	KGT06-08
	Ø 8	Ø 10	KGT08-10
	Ø 10	Ø 12	KGT10-12

Union tee

KGT

Use to connect tubes in both 90° directions.

	Applicable tubing O.D. [mm]		Model
	(a)	(b)	
	Ø 4	Ø 6	KGT04-00
	Ø 6	Ø 8	KGT06-00
	Ø 8	Ø 10	KGT08-00
	Ø 10	Ø 12	KGT10-00
	Ø 12	Ø 16	KGT12-00
	Ø 16	Ø 20	KGT16-00

Different dia. union "Y"

KGU

Use to connect tubes in the same direction, reducing the size of tubes.

	Applicable tubing O.D. [mm]		Model
	(a)	(b)	
	Ø 4	Ø 6	KGU04-06
	Ø 6	Ø 8	KGU06-08
	Ø 8	Ø 10	KGU08-10
	Ø 10	Ø 12	KGU10-12

Union "Y"

KGU

Use to branch line in the same direction.

	Applicable tubing O.D. [mm]		Model
	(a)	(b)	
	Ø 4	Ø 6	KGU04-00
	Ø 6	Ø 8	KGU06-00
	Ø 8	Ø 10	KGU08-00
	Ø 10	Ø 12	KGU10-00
	Ø 12	Ø 16	KGU12-00

Different dia. double union "Y"

KGUD

Use to four-branch line in the same direction.

	Applicable tubing O.D. [mm]		Model
	(a)	(b)	
	Ø 4	Ø 6	KGUD04-06
	Ø 6	Ø 8	KGUD06-08

Different diameter straight

KGH

Use to connect different sized tubes.

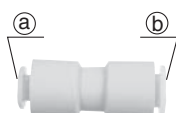
	Applicable tubing O.D. [mm]		Model
	(a)	(b)	
	Ø 4	Ø 6	KGH04-06
	Ø 6	Ø 8	KGH06-08
	Ø 8	Ø 10	KGH08-10
	Ø 10	Ø 12	KGH10-12

Branch union elbow

KGLU

Use to branch line at right angles.

	Applicable tubing O.D. [mm]	Model
	Ø 4	KGLU04-00
Ø 6	KGLU06-00	
Ø 8	KGLU08-00	
Ø 10	KGLU10-00	
Ø 12	KGLU12-00	

Note) For dimensions and other details refer to specific catalogue of the series at www.smc.eu

Delta union

KGD

Use to branch line in triple 90° direction.



Applicable tubing O.D. [mm]	Model
Ø 4	KGD04-00
Ø 6	KGD06-00
Ø 8	KGD08-00
Ø 10	KGD10-00
Ø 12	KGD12-00

Plug-in elbow

KGL

Use to change by 90° in a tube fetching direction from One-touch fittings.

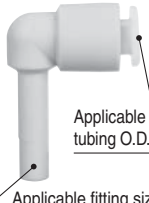

Applicable tubing O.D. [mm]	Applicable fitting size	Model
Ø 4	Ø 4	KGL04-99
Ø 6	Ø 6	KGL06-99
Ø 8	Ø 8	KGL08-99
Ø 10	Ø 10	KGL10-99
Ø 12	Ø 12	KGL12-99

Plug-in reducer

KGR

Use to change size of One-touch fittings.



Applicable tubing O.D. [mm]	Applicable fitting size	Model
Ø 4	Ø 6	KGR04-06
	Ø 8	KGR04-08
	Ø 10	KGR04-10
Ø 6	Ø 4	KGR06-04
	Ø 8	KGR06-08
	Ø 10	KGR06-10
	Ø 12	KGR06-12
Ø 8	Ø 10	KGR08-10
	Ø 12	KGR08-12
Ø 10	Ø 12	KGR10-12
	Ø 16	KGR10-16
Ø 12	Ø 16	KGR12-16

Female connector

KGF

Use to pipe from male thread such as pressure gauge.



Applicable tubing O.D. [mm]	Connection thread	Model
Ø 4	Rc 1/8	KGF04-01
	Rc 1/4	KGF04-02
Ø 6	Rc 1/8	KGF06-01
	Rc 1/4	KGF06-02
	Rc 3/8	KGF06-03
Ø 8	Rc 1/8	KGF08-01
	Rc 1/4	KGF08-02
	Rc 3/8	KGF08-03
Ø 10	Rc 1/4	KGF10-02
	Rc 3/8	KGF10-03
Ø 12	Rc 1/4	KGF12-02
	Rc 3/8	KGF12-03
	Rc 1/2	KGF12-04

Bulkhead connector

KGE

Use to connect male thread and tube through a panel.



Applicable tubing O.D. [mm]	Connection thread	Model
Ø 4	Rc 1/8	KGE04-01
	Rc 1/4	KGE04-02
Ø 6	Rc 1/8	KGE06-01
	Rc 1/4	KGE06-02
	Rc 3/8	KGE06-03
Ø 8	Rc 1/8	KGE08-01
	Rc 1/4	KGE08-02
	Rc 3/8	KGE08-03
Ø 10	Rc 1/4	KGE10-02
	Rc 3/8	KGE10-03
Ø 12	Rc 3/8	KGE12-03
	Rc 1/2	KGE12-04
Ø 16	Rc 3/8	KGE16-03
	Rc 1/2	KGE16-04

Tube cap

KGC

Use to plug unused tubing.



Applicable tubing O.D. [mm]	Model
Ø 4	KGC04-00
Ø 6	KGC06-00
Ø 8	KGC08-00
Ø 10	KGC10-00
Ø 12	KGC12-00
Ø 16	KGC16-00

Note) For dimensions and other details refer to specific catalogue of the series at www.smc.eu



Made to Order

1 Grease-free Specifications

Symbol	Specifications
X17	Grease-free Rubber material: NBR (With fluorine coating) Release button colour: Light blue
X39	Grease-free Rubber material: NBR (With fluorine coating) Release button colour: Light blue Clean (Copper-free, air blow, double package)
X94	Grease-free Rubber material: FKM (With fluorine coating) Release button colour: Light blue

Suffix "-X17" to the end of part number.

Example) **KGH06-01-X17**

2 Other Specifications

Symbol	Specifications
X12	Lubricant: White vaseline Release button colour: White
X34	Rubber material: FKM

3 Clean Series

Symbol	Specifications
10-	Lubricant: Fluorine-based grease Double package

Example) **10-KGH06-02**

Spare Parts

Description	Part no.	Applicable thread	Applicable model
Gasket	M-5G2	M5	—
Pipe nut	KG04-P01	—	KGE04-00,KGE04-01,KGE04-02
	KG06-P01	—	KGE06-00,KGE06-01 KGE06-02,KGE06-03
	KG08-P01	—	KGE08-00,KGE08-01 KGE08-02,KGE08-03
	KG10-P01	—	KGE10-00,KGE10-02,KGE10-03
	KG12-P01	—	KGE12-00,KGE12-03,KGE12-04
	KG16-P01	—	KGE16-00,KGE16-03,KGE16-04

Stainless Steel 316 Insert Fittings

RoHS

Fittings

KFG2 Series

■ Applicable tubing O.D. : Metric Size

■ Connection thread : R, Rc

Material: Stainless steel 316

Fluid temperature: 260 °C

Note) Swivel elbow/With sealant: 150 °C

Applicable tubing material:

FEP, PFA, Denatured PTFE

Nylon, Soft nylon

Polyurethane

Polyolefin, Soft polyolefin

Hard polyurethane

Antistatic soft nylon

Antistatic polyurethane

Can be used with steam.

Grease-free

Compatible with the Food Sanitation Law

(Component materials have met apparatuses and container-packages standards.)



Corrosion Resistant

Heat Resistant

Applicable Tubing

Tubing material (Note)	FEP, PFA, Denatured PTFE, Nylon, Soft nylon, Polyurethane, Soft polyurethane, Polyolefin, Soft polyolefin, Antistatic soft nylon, Antistatic polyurethane, Hard polyurethane
Tubing O.D.	Ø 4 x Ø 2.5, Ø 4 x Ø 3, Ø 6 x Ø 4, Ø 8 x Ø 6, Ø 10 x Ø 7.5 Ø 10 x Ø 8, Ø 12 x Ø 9, Ø 12 x Ø 10, Ø 16 x Ø 13

Note) For soft polyurethane tubing, hard polyurethane tubing, antistatic polyurethane tubing, water cannot be used.

Series	Tubing material	Tubing O.D. x I.D. [mm]									
		Ø 4 x Ø 2.5	Ø 4 x Ø 3	Ø 6 x Ø 4	Ø 8 x Ø 6	Ø 10 x Ø 7.5	Ø 10 x Ø 8	Ø 12 x Ø 9	Ø 12 x Ø 10	Ø 16 x Ø 13	
TH	FEP	●	—	●	●	●	●	●	●	—	
TL	PFA	—	●	●	●	—	●	—	●	—	
TD	Denatured PTFE	●	—	●	●	●	—	●	—	—	
T	Nylon	●	●	●	●	●	—	●	—	●	
TS	Soft nylon	●	—	●	●	●	—	●	—	—	
TU	Polyurethane	●	—	●	—	—	—	—	—	—	
TPH	Polyolefin	●	—	●	●	●	—	●	—	—	
TUS	Soft polyurethane	●	—	●	—	—	—	—	—	—	
TUH	Hard polyurethane (High pressure)	●	—	●	—	—	—	—	—	—	
TPS	Soft polyolefin	●	—	●	—	—	—	—	—	—	
TAS	Antistatic soft nylon	●	—	●	—	—	—	—	—	—	
TAU	Antistatic polyurethane	●	—	●	—	—	—	—	—	—	

Specifications

Fluid	Air, Water, Steam (Note 2) (Note 3)
Operating pressure range (Note 1)	–100 kPa to 1 MPa (Note 4)
Proof pressure	3.0 MPa
Ambient and fluid temperature	–65 to 260 °C (No freezing) (Note 4) [Swivel elbow and with sealant types: –5 to 150 °C]
Lubricant	Grease-free specification
Seal on the threads	Without sealant (With sealant type compatible) (Note 5)

Note 1) Avoid using in a vacuum holding application such as a leak tester, since there is leakage.

Note 2) Consult with SMC regarding applicable tubing separately.

Note 3) Using special FKM that is resistant even when steam is used.

Note 4) Check the operating pressure range and operating temperature range of the tube.

Note 5) With sealant: Suffix "S" to the end of part number.

Note 6) Union nut is shipped together.

Superior tube mounting

Union nut

Light tightening torque
Comparison with existing model

Approx. **60 %** down

*Comparison with KFG□0806

Barb

Sealing performance and holding of tube
are secured by backup from the barb.

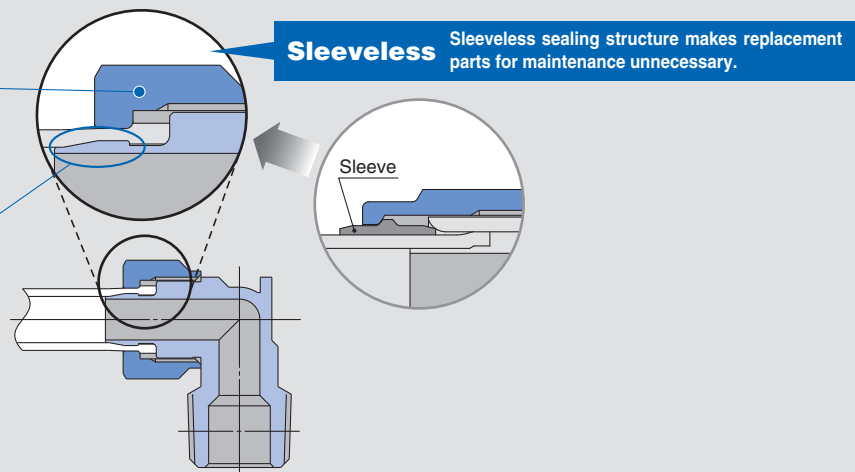

KQ2

KQ2
-Uni

KQB2

KS/
KX

KM

KF

M

H/DL
L/LL

KC

KK

KKH

KK
130

DM

DMK

KDM

MQR

KB

KR
-W2

KRM

KA

KQG2

KG

KFG2

MS

KKA

KP

KPQ/
KPG

LQ1

LQ3

LQHB

Male connector

KFG2H

Applicable tubing size [mm]		Connection thread	Model
O.D.	I.D.		
Ø 4	Ø 2.5	R 1/8	KFG2H0425-01
		R 1/4	KFG2H0425-02
Ø 4	Ø 3	R 1/8	KFG2H0403-01
		R 1/4	KFG2H0403-02
Ø 6	Ø 4	R 1/8	KFG2H0604-01
		R 1/4	KFG2H0604-02
Ø 8	Ø 6	R 1/8	KFG2H0806-01
		R 1/4	KFG2H0806-02
		R 3/8	KFG2H0806-03
Ø 10	Ø 7.5	R 1/4	KFG2H1075-02
		R 3/8	KFG2H1075-03
		R 1/2	KFG2H1075-04
Ø 10	Ø 8	R 1/4	KFG2H1008-02
		R 3/8	KFG2H1008-03
		R 1/2	KFG2H1008-04
Ø 12	Ø 9	R 1/4	KFG2H1209-02
		R 3/8	KFG2H1209-03
		R 1/2	KFG2H1209-04
Ø 12	Ø 10	R 1/4	KFG2H1210-02
		R 3/8	KFG2H1210-03
		R 1/2	KFG2H1210-04
Ø 16	Ø 13	R 3/8	KFG2H1613-03
		R 1/2	KFG2H1613-04



Male branch tee

KFG2T

Applicable tubing size [mm]		Connection thread	Model
O.D.	I.D.		
Ø 4	Ø 2.5	R 1/8	KFG2T0425-01
		R 1/4	KFG2T0425-02
Ø 4	Ø 3	R 1/8	KFG2T0403-01
		R 1/4	KFG2T0403-02
Ø 6	Ø 4	R 1/8	KFG2T0604-01
		R 1/4	KFG2T0604-02
Ø 8	Ø 6	R 1/8	KFG2T0806-01
		R 1/4	KFG2T0806-02
		R 3/8	KFG2T0806-03
Ø 10	Ø 7.5	R 1/4	KFG2T1075-02
		R 3/8	KFG2T1075-03
		R 1/2	KFG2T1075-04
Ø 10	Ø 8	R 1/4	KFG2T1008-02
		R 3/8	KFG2T1008-03
		R 1/2	KFG2T1008-04
Ø 12	Ø 9	R 1/4	KFG2T1209-02
		R 3/8	KFG2T1209-03
		R 1/2	KFG2T1209-04
Ø 12	Ø 10	R 1/4	KFG2T1210-02
		R 3/8	KFG2T1210-03
		R 1/2	KFG2T1210-04
Ø 16	Ø 13	R 3/8	KFG2T1613-03
		R 1/2	KFG2T1613-04



Male elbow

KFG2L

Applicable tubing size [mm]		Connection thread	Model
O.D.	I.D.		
Ø 4	Ø 2.5	R 1/8	KFG2L0425-01
		R 1/4	KFG2L0425-02
Ø 4	Ø 3	R 1/8	KFG2L0403-01
		R 1/4	KFG2L0403-02
Ø 6	Ø 4	R 1/8	KFG2L0604-01
		R 1/4	KFG2L0604-02
Ø 8	Ø 6	R 1/8	KFG2L0806-01
		R 1/4	KFG2L0806-02
		R 3/8	KFG2L0806-03
Ø 10	Ø 7.5	R 1/4	KFG2L1075-02
		R 3/8	KFG2L1075-03
		R 1/2	KFG2L1075-04
Ø 10	Ø 8	R 1/4	KFG2L1008-02
		R 3/8	KFG2L1008-03
		R 1/2	KFG2L1008-04
Ø 12	Ø 9	R 1/4	KFG2L1209-02
		R 3/8	KFG2L1209-03
		R 1/2	KFG2L1209-04
Ø 12	Ø 10	R 1/4	KFG2L1210-02
		R 3/8	KFG2L1210-03
		R 1/2	KFG2L1210-04
Ø 16	Ø 13	R 3/8	KFG2L1613-03
		R 1/2	KFG2L1613-04



Straight union

KFG2H

Applicable tubing size mm		Model
O.D.	I.D.	
Ø 4	Ø 2.5	KFG2H0425-00
Ø 4	Ø 3	KFG2H0403-00
Ø 6	Ø 4	KFG2H0604-00
Ø 8	Ø 6	KFG2H0806-00
Ø 10	Ø 7.5	KFG2H1075-00
Ø 10	Ø 8	KFG2H1008-00
Ø 12	Ø 9	KFG2H1209-00
Ø 12	Ø 10	KFG2H1210-00
Ø 16	Ø 13	KFG2H1613-00

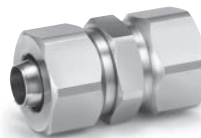

Union tee

KFG2T

Applicable tubing size mm		Model
O.D.	I.D.	
Ø 4	Ø 2.5	KFG2T0425-00
Ø 4	Ø 3	KFG2T0403-00
Ø 6	Ø 4	KFG2T0604-00
Ø 8	Ø 6	KFG2T0806-00
Ø 10	Ø 7.5	KFG2T1075-00
Ø 10	Ø 8	KFG2T1008-00
Ø 12	Ø 9	KFG2T1209-00
Ø 12	Ø 10	KFG2T1210-00
Ø 16	Ø 13	KFG2T1613-00



Note) For dimensions and other details refer to specific catalogue of the series at www.smc.eu

Bulkhead union

KFG2E



Applicable tubing size [mm]		Model
O.D.	I.D.	
Ø 4	Ø 2.5	KFG2E0425-00
Ø 4	Ø 3	KFG2E0403-00
Ø 6	Ø 4	KFG2E0604-00
Ø 8	Ø 6	KFG2E0806-00
Ø 10	Ø 7.5	KFG2E1075-00
Ø 10	Ø 8	KFG2E1008-00
Ø 12	Ø 9	KFG2E1209-00
Ø 12	Ø 10	KFG2E1210-00
Ø 16	Ø 13	KFG2E1613-00

Female connector

KFG2F



Applicable tubing size [mm]		Connection thread	Model
O.D.	I.D.		
Ø 4	Ø 2.5	R 1/4	KFG2F0425-02
Ø 4	Ø 3	R 1/4	KFG2F0403-02
Ø 6	Ø 4	R 1/4	KFG2F0604-02
Ø 8	Ø 6	R 3/8	KFG2F0806-03
Ø 10	Ø 7.5	R 3/8	KFG2F1075-03
Ø 10	Ø 8	R 3/8	KFG2F1008-03
Ø 12	Ø 9	R 3/8	KFG2F1209-03
Ø 12	Ø 10	R 3/8	KFG2F1210-03
Ø 16	Ø 13	R 1/2	KFG2F1613-04

Union elbow

KFG2L



Applicable tubing size [mm]		Model
O.D.	I.D.	
Ø 4	Ø 2.5	KFG2L0425-00
Ø 4	Ø 3	KFG2L0403-00
Ø 6	Ø 4	KFG2L0604-00
Ø 8	Ø 6	KFG2L0806-00
Ø 10	Ø 7.5	KFG2L1075-00
Ø 10	Ø 8	KFG2L1008-00
Ø 12	Ø 9	KFG2L1209-00
Ø 12	Ø 10	KFG2L1210-00
Ø 16	Ø 13	KFG2L1613-00

Union nut

KFG2N



Applicable tubing size [mm]	Model
Ø 4	KFG2N-04
Ø 6	KFG2N-06
Ø 8	KFG2N-08
Ø 10	KFG2N-10
Ø 12	KFG2N-12
Ø 16	KFG2N-16

Swivel elbow

KFG2V



Applicable tubing size [mm]		Connection thread	Model
O.D.	I.D.		
Ø 4	Ø 2.5	R 1/8	KFG2V0425-01
		R 1/4	KFG2V0425-02
Ø 4	Ø 3	R 1/8	KFG2V0403-01
		R 1/4	KFG2V0403-02
Ø 6	Ø 4	R 1/8	KFG2V0604-01
		R 1/4	KFG2V0604-02
Ø 8	Ø 6	R 1/8	KFG2V0806-01
		R 1/4	KFG2V0806-02
Ø 8	Ø 6	R 3/8	KFG2V0806-03
		R 1/4	KFG2V1075-02
Ø 10	Ø 7.5	R 3/8	KFG2V1075-03
		R 1/2	KFG2V1075-04
Ø 10	Ø 8	R 1/4	KFG2V1008-02
		R 3/8	KFG2V1008-03
Ø 10	Ø 8	R 1/2	KFG2V1008-04
		R 1/4	KFG2V1209-02
Ø 12	Ø 9	R 3/8	KFG2V1209-03
		R 1/2	KFG2V1209-04
Ø 12	Ø 10	R 1/4	KFG2V1210-02
		R 3/8	KFG2V1210-03
Ø 12	Ø 10	R 1/2	KFG2V1210-04
		R 3/8	KFG2V1613-03
Ø 16	Ø 13	R 1/2	KFG2V1613-04

Spare Parts

Description	Tubing O.D.	Part no.	Material
Bulkhead nut	Ø 4	KFG204-P01	Stainless steel 316 (Fluoro coated)
	Ø 6	KFG206-P01	
	Ø 8	KFG208-P01	
	Ø 10	KFG210-P01	
	Ø 12	KFG212-P01	
	Ø 16	KFG216-P01	

Note) For dimensions and other details refer to specific catalogue of the series at www.smc.eu

- KQ2
- KQ2-Uni
- KQB2
- KS/KX
- KM
- KF
- M
- H/DL L/LL
- KC
- KK
- KKH
- KK 130
- DM
- DMK
- KDM
- MQR
- KB
- KR-W2
- KRM
- KA
- KQG2
- KG
- KFG2**
- MS
- KKA
- KP
- KPQ/KPG
- LQ1
- LQ3
- LQHB

Miniature Fittings/Stainless Steel 316

RoHS

MS Series

■ Applicable tubing O.D. : Metric Size

■ Connection thread : M5, R 1/8

Corrosion Resistant

**For use in corrosive environments
Stainless steel 316**

Compact piping space

Tube has a large retaining force. Hose nipple assures easy installation and removal.

Line up various types

Possible for special tubing in the same direction. Accepts many styles of plastic tubing

Hose nipple and hose elbow

Accepts nylon, soft nylon, and polyurethane tubing.

Specifications

Applicable tubing material	Nylon	Soft nylon		Polyurethane	Super PFA ^{Note 1)}	FEP ^{Note 2)}	Denatured PTFE ^{Note 3)}
Applicable tubing O.D. / I.D.	Ø 4/Ø 2.5 Ø 6/Ø 4	Ø 3.18/Ø 2.18	Ø 4/Ø 2.5 Ø 6/Ø 4	Ø 3.18/Ø 2 Ø 4/Ø 2.5 Ø 6/Ø 4	Ø 6/Ø 4	Ø 4/Ø 2.5 Ø 6/Ø 4	Ø 4/Ø 2.5 Ø 6/Ø 4
Fluid	Air/Water ^{Note 4)}						
Max. operating pressure (at 20 °C)	1.5 MPa	1 MPa		0.8 MPa	1 MPa	1.5 MPa	1.4 MPa
Ambient and fluid temperature	-5 to 60 °C, Water: 0 to 40 °C (No freezing)						
Port size	M5						
Thread	JIS B0205 (Metric coarse thread)				JIS B0205 (Metric coarse thread)		

Note 1), Note 2), Note 3) Applicable only for hose nipple type.

Note 4) Barb fitting, barb elbow and barb tee are not compatible with water.



Hose nipple

Barb

Configuration for easy insertion into the tube
Holds the tube tightly.

Body

Stainless steel 316

Gasket

Low tightening torque
Tight seal

Tube

Possible for combination use of nylon tubing and polyurethane tubing.

Cap nut

Certainly hold the tube by manual clamping
Easy removal of tube by loosening
Stainless steel 316

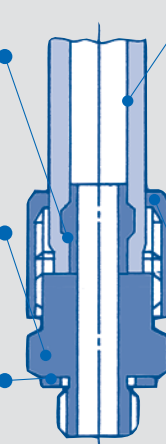

Barb fitting

Barb

Configuration for easy insertion into the tube
Holds the tube tightly.

Body

Stainless steel 316

Tube



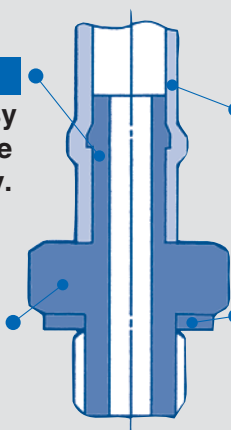

Gasket







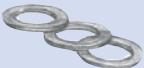

Low tightening torque
Tight seal



Applicable tubing O.D.: $\varnothing 3.18$, $\varnothing 4$, $\varnothing 6$

Port size: M5

Description	Note	Model	Application	
Barb fitting for soft tube 	$\varnothing 3.18/\varnothing 2.18$ x M5	MS-5AU-3	For soft nylon tubing	
	$\varnothing 3.18/\varnothing 2$ x M5		For polyurethane tubing	
	$\varnothing 4/\varnothing 2.5$ x M5	MS-5AU-4	For soft nylon and polyurethane tubing	
$\varnothing 6/\varnothing 4$ x M5	MS-5AU-6			
Barb elbow for soft tubing 	$\varnothing 3.18/\varnothing 2.18$ x M5	MS-5ALHU-3	Body rotates at 360° around the stud axis	For soft nylon tubing
	$\varnothing 3.18/\varnothing 2$ x M5			For polyurethane tubing
	$\varnothing 4/\varnothing 2.5$ x M5	MS-5ALHU-4		For soft nylon and polyurethane tubing
	$\varnothing 6/\varnothing 4$ x M5	MS-5ALHU-6		
Hose nipple 	$\varnothing 4/\varnothing 2.5$ x M5	MS-5H-4	For nylon, soft nylon and polyurethane tubing	
	$\varnothing 6/\varnothing 4$ x M5	MS-5H-6		
Hose elbow 	$\varnothing 4/\varnothing 2.5$ x M5	MS-5HLH-4	<ul style="list-style-type: none"> For nylon, soft nylon and polyurethane tubing Body rotates at 360° around the stud axis 	
	$\varnothing 6/\varnothing 4$ x M5	MS-5HLH-6		
Gasket 	Material: PVC	M-5G1	Seal on the M5 threads	

Description	Note	Model	Application	
Universal elbow 	M5 female x M5 male	MS-5UL	Body rotates at 360° around the stud axis	
Universal tee 	M5 female x M5 female x M5 male	MS-5UT	Body rotates at 360° around the stud axis	
Bushing 	R 1/8 x M5 female	MS-5B	FoReducing Rc 1/8 female to M5.	
Plug 		MS-5P	Use to plug unused M5 port.	
Extension fitting 	M5 male x M5 female	MS-5J	Solid piece moves fitting up from workpiece	
Nipple 	M5 male x M5 male	MS-5N	Fitting to workpiece and fitting to fitting connection	
Universal nipple 	M5 male x M5 male	MS-5UN	Body rotates at 360° around the stud axis	
Barb tee for soft tube 	$\varnothing 3.18/\varnothing 2.18$ x M5	MS-5ATHU-3	Body rotates at 360° around the stud axis	For soft nylon tubing
	$\varnothing 3.18/\varnothing 2$ x M5			For polyurethane tubing
	$\varnothing 4/\varnothing 2.5$ x M5	MS-5ATHU-4		For soft nylon and polyurethane tubing
	$\varnothing 6/\varnothing 4$ x M5	MS-5ATHU-6		
Gasket (H) 	Material: Nylon 66, GF 30 %	M-5GH	Used only for MS-5ALHU-6, MS-5HLH-4, MS-5HLH-6 and MS-5ATHU-6.	

KQ2

KQ2-Uni

KQB2

KS/KX

KM

KF

M

 H/DL
L/LL

KC

KK

KKH

 KK
130

DM

DMK

KDM

MQR

KB

 KR
-W2

KRM

KA

KQG2

KG

KFG2

MS

KKA

KP

 KPQ/
KPG

LQ1

LQ3

LQHB



Made to Order

1 Gasket Material Modification

Symbol	Specifications	
X83	Gasket material: Stainless steel 304, NBR	
	Applicable thread	Gasket part no.
	M5	M-5G2
X112	Gasket material: Stainless steel 316, Special FKM	
	Applicable thread	Gasket part no.
	M5	M-5G3

Suffix "-X83" to the end of part number.

Example) **MS-5AU-4-X83**

2 Clean Series

Symbol	Specifications
10-	Lubricant: Fluorine-based grease (Only MS-5UN) Double package

Example) **10-MS-5AN-4**

Spare Parts

Description	Part no.	Applicable thread	Material	Applicable model
Gasket	M-5G1	M5	PVC	—
	M-5G2		Stainless steel 304, NBR	—
	M-5G3		Stainless steel 316, Special FKM	—
	M-5GH		Nylon 66, GF 30 %	MS-5ALHU-6 MS-5HLH-4 MS-5HLH-6 MS-5ATHU-6
Cap nut	MS-5-4-P01	—	Stainless steel 316	MS-5H-4 MS-5HL-4 MS-5HLH-4
	MS-5-6-P01	—	Stainless steel 316	MS-5H-6 MS-5HL-6 MS-5HLH-6

S Couplers/Stainless Steel Type

RoHS

Fittings

KKA Series

■ Connection type : R, Rc

Corrosion Resistant

Heat Resistant

Material/

Metal parts: **Stainless steel 304**

Seal parts: Special **FKM**

Port sizes of R 1/8 to R 1 1/2 are standardised.



Both plug and socket have an integral check valve.

Available with and without check valves depending on the operating conditions.

Reduces liquid dripping when the plug and socket are uncoupled.

Body size	Liquid dripping [cm ³] at each removal	Aeration [cm ³] at each removal
KKA3	0.02	0.1
KKA4	0.04	0.1
KKA6	0.06	0.2
KKA7	0.14	0.5
KKA8	0.27	0.9
KKA9	0.77	2.7

Liquid dripping:

Volume of water leakage at the time when the plug and socket are uncoupled.

Aeration:

Volume of external air entrained when the plug and socket are connected.

Symbol

	Single plug	Single socket
With check valve		
Without check valve		
Connected plug and socket		
Check valve on both sides:		
Check valve on single side:		
No check valve on either side:		

Specifications

Fluid	Water/Air
Operating pressure range ^(Note)	KKA3: -100 kPa to 1 MPa KKA4, 6, 7, 8, 9: 0 to 1 MPa
Proof pressure	10 MPa
Ambient and fluid temperature	-5 to 150 °C (No freezing) <small>Note) This product should not be used with steam. This product should not be used with steam.</small>
Non-greased specification	No grease is used. <small>(Rubber: Fluorine coated, Metal sliding parts: Plated with fluorine-contained material)</small>
Material	Metal part: Stainless steel 304, Rubber material: Fluororubber (Special FKM)
Seal	With male thread sealant

Note) Do not use the S couplers with a leak tester or for vacuum retention because they are not guaranteed for zero leakage.

Performance

Plug and socket connection	One-touch connection and release
Check valve	Check valve on both sides, Without check valve

Note) Series KKA cannot be connected with Series KK or Series KKH.

Effective Area

Built-in check valve	Plug	Socket	Effective area [mm ²]
Plug: With check valve Socket: With check valve	KKA3P-01F	KKA3S-01F	17.4
	KKA4P-02F	KKA4S-02F	26.4
	KKA6P-04F	KKA6S-04F	54.2
	KKA7P-06F	KKA7S-06F	99.6
	KKA8P-10F	KKA8S-10F	168.3
	KKA9P-12F	KKA9S-12F	332.1
Plug: Without check valve Socket: With check valve	KKA3P-01M-1	KKA3S-01M	18.5
	KKA4P-02M-1	KKA4S-02M	31.8
	KKA6P-04M-1	KKA6S-04M	55.3
Plug: Without check valve Socket: Without check valve	KKA3P-01M-1	KKA3S-01M-1	22.6
	KKA4P-02M-1	KKA4S-02M-1	40.2
	KKA6P-04M-1	KKA6S-04M-1	76.0

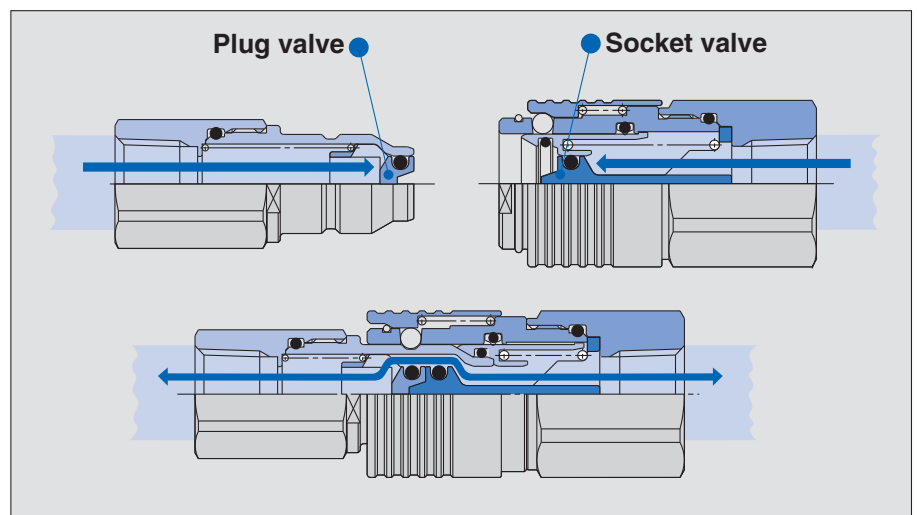

- KQ2
- KQ2-Uni
- KQB2
- KS/KX
- KM
- KF
- M
- H/DL L/LL
- KC
- KK
- KKH
- KK 130
- DM
- DMK
- KDM
- MQR
- KB
- KR -W2
- KRM
- KA
- KQG2
- KG
- KFG2
- MS
- KKA
- KP
- KPQ/KPG
- LQ1
- LQ3
- LQHB

With check valve

Plug (P)

Socket (S)

Male thread type

Male thread type



Body size	Port size	Model
1/8	R 1/8	KKA3P-01M
	R 1/4	KKA3P-02M
	R 3/8	KKA3P-03M
1/4	R 1/4	KKA4P-02M
	R 3/8	KKA4P-03M
	R 1/2	KKA4P-04M
1/2	R 3/8	KKA6P-03M
	R 1/2	KKA6P-04M
	R 3/4	KKA6P-06M
3/4	R 1/2	KKA7P-04M
	R 3/4	KKA7P-06M
	R 1	KKA7P-10M
1	R 3/4	KKA8P-06M
	R 1	KKA8P-10M
	R 1 1/4	KKA8P-12M
1 1/4	R 1	KKA9P-10M
	R 1 1/4	KKA9P-12M
	R 1 1/2	KKA9P-14M

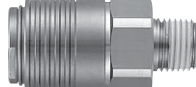

Body size	Port size	Model
1/8	R 1/8	KKA3S-01M
	R 1/4	KKA3S-02M
	R 3/8	KKA3S-03M
1/4	R 1/4	KKA4S-02M
	R 3/8	KKA4S-03M
	R 1/2	KKA4S-04M
1/2	R 3/8	KKA6S-03M
	R 1/2	KKA6S-04M
	R 3/4	KKA6S-06M
3/4	R 1/2	KKA7S-04M
	R 3/4	KKA7S-06M
	R 1	KKA7S-10M
1	R 3/4	KKA8S-06M
	R 1	KKA8S-10M
	R 1 1/4	KKA8S-12M
1 1/4	R 1	KKA9S-10M
	R 1 1/4	KKA9S-12M
	R 1 1/2	KKA9S-14M

Female thread type

Female thread type



Body size	Port size	Model
1/8	Rc 1/8	KKA3P-01F
	Rc 1/4	KKA3P-02F
	Rc 3/8	KKA3P-03F
1/4	Rc 1/4	KKA4P-02F
	Rc 3/8	KKA4P-03F
	Rc 1/2	KKA4P-04F
1/2	Rc 3/8	KKA6P-03F
	Rc 1/2	KKA6P-04F
	Rc 3/4	KKA6P-06F
3/4	Rc 1/2	KKA7P-04F
	Rc 3/4	KKA7P-06F
	Rc 1	KKA7P-10F
1	Rc 3/4	KKA8P-06F
	Rc 1	KKA8P-10F
	Rc 1 1/4	KKA8P-12F
1 1/4	Rc 1	KKA9P-10F
	Rc 1 1/4	KKA9P-12F
	Rc 1 1/2	KKA9P-14F

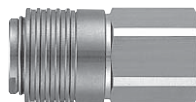

Body size	Port size	Model
1/8	Rc 1/8	KKA3S-01F
	Rc 1/4	KKA3S-02F
	Rc 3/8	KKA3S-03F
1/4	Rc 1/4	KKA4S-02F
	Rc 3/8	KKA4S-03F
	Rc 1/2	KKA4S-04F
1/2	Rc 3/8	KKA6S-03F
	Rc 1/2	KKA6S-04F
	Rc 3/4	KKA6S-06F
3/4	Rc 1/2	KKA7S-04F
	Rc 3/4	KKA7S-06F
	Rc 1	KKA7S-10F
1	Rc 3/4	KKA8S-06F
	Rc 1	KKA8S-10F
	Rc 1 1/4	KKA8S-12F
1 1/4	Rc 1	KKA9S-10F
	Rc 1 1/4	KKA9S-12F
	Rc 1 1/2	KKA9S-14F

Note) For dimensions and other details refer to specific catalogue of the series at www.smc.eu

Without check valve

Plug (P)

Male thread type



Body size	Port size	Model
1/8	R 1/8	KKA3P-01M-1
	R 1/4	KKA3P-02M-1
	R 3/8	KKA3P-03M-1
1/4	R 1/4	KKA4P-02M-1
	R 3/8	KKA4P-03M-1
	R 1/2	KKA4P-04M-1
1/2	R 3/8	KKA6P-03M-1
	R 1/2	KKA6P-04M-1
	R 3/4	KKA6P-06M-1

Female thread type



Body size	Port size	Model
1/8	Rc 1/8	KKA3P-01F-1
	Rc 1/4	KKA3P-02F-1
	Rc 3/8	KKA3P-03F-1
1/4	Rc 1/4	KKA4P-02F-1
	Rc 3/8	KKA4P-03F-1
	Rc 1/2	KKA4P-04F-1
1/2	Rc 3/8	KKA6P-03F-1
	Rc 1/2	KKA6P-04F-1
	Rc 3/4	KKA6P-06F-1

Socket (S)

Male thread type

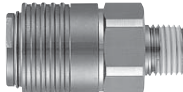

Body size	Port size	Model
1/8	R 1/8	KKA3S-01M-1
	R 1/4	KKA3S-02M-1
	R 3/8	KKA3S-03M-1
1/4	R 1/4	KKA4S-02M-1
	R 3/8	KKA4S-03M-1
	R 1/2	KKA4S-04M-1
1/2	R 3/8	KKA6S-03M-1
	R 1/2	KKA6S-04M-1
	R 3/4	KKA6S-06M-1

Female thread type

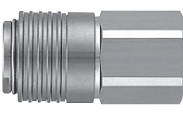

Body size	Port size	Model
1/8	Rc 1/8	KKA3S-01F-1
	Rc 1/4	KKA3S-02F-1
	Rc 3/8	KKA3S-03F-1
1/4	Rc 1/4	KKA4S-02F-1
	Rc 3/8	KKA4S-03F-1
	Rc 1/2	KKA4S-04F-1
1/2	Rc 3/8	KKA6S-03F-1
	Rc 1/2	KKA6S-04F-1
	Rc 3/4	KKA6S-06F-1

Note) For dimensions and other details refer to specific catalogue of the series at www.smc.eu

- KQ2
- KQ2-Uni
- KQB2
- KS/KX
- KM
- KF
- M
- H/DL L/LL
- KC
- KK
- KKH
- KK 130
- DM
- DMK
- KDM
- MQR
- KB
- KR-W2
- KRM
- KA
- KQG2
- KG
- KFG2
- MS
- KKA**
- KP
- KPQ/KPG
- LQ1
- LQ3
- LQHB

Stainless Steel S-coupler with Identification Ring

KK A6P / KKA6S Series

■ When installing multiple tubes, the connection destination can be checked with colour coding.

Please contact SMC for availability

KK A6P-03F-□-X237 (Plug), KKA6S-03M-□-X237 (Socket) Series



Identification ring colour:



Grease-free

Check valve on both sides

Material: Stainless steel 304, FKM

Identification ring colour (Symbol)	Plug	Socket
Red		
Blue		
Yellow		
White		

Operating pressure range: 0 to 1.0 MPa

Fluid: Water, Air

(Cannot be used with steam)

Operating temperature: -5 °C to 150 °C

(No freezing)

Port size: Plug Rc 3/8,
Socket R 3/8

(with sealant)

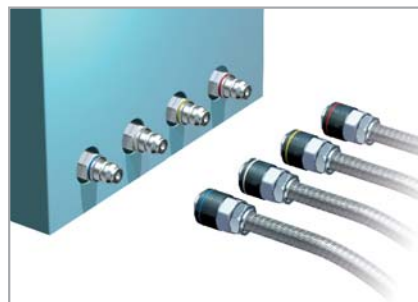

Clean One-touch Fittings (for blowing)



Fittings

KP Series

■ Applicable tubing O.D. : Metric Size

■ Connection thread : R

Clean

Completely oil free (Rubber parts are fluorine-coated.)
Liquid-contact areas are non-metallic.
Parts cleaning, assembly and double packaging in a clean room
Can be used for vacuum (-100 kPa).



Recommended Applicable Tubing

Tubing material	PFA, Polyolefin Soft polyolefin, Polyurethane
Tubing O.D.	Ø 4, Ø 6, Ø 8, Ø 10, Ø 12

Note 1) FEP, nylon and soft nylon tubing, and tubing not compatible with the clean series can also be used. However, the degree of clean performance will be reduced.
Note 2) Due to the softness of polyurethane tubing, it may fold when being inserted. Hold the end of the tubing and insert it all the way in.

Specifications

Cleanliness class (ISO)	Class 3 ^{Note 1)}
Fluid	Air/Nitrogen gas/Water (pure water) ^{Note 2)}
Maximum operating pressure (20 °C)	1 MPa ^{Note 3)}
Operating vacuum pressure	-100 kPa {10 Torr}
Proof pressure (20 °C)	3 MPa
Ambient and fluid temperature	-20 to 80 °C
Thread	JIS B0203 (Taper thread for piping)

Note 1) Refer to particle generation classifications.
Note 2) The surge pressure must be under the maximum operating pressure.
Note 3) The maximum operating pressure is the value at 20 °C. Refer to the operating pressure curve for other temperatures.
Note 4) Do not use the fittings with a leak tester or for vacuum retention because they are not guaranteed for zero leakage.

Caution

Series KP is a line of special One-touch fittings for use in clean room blowing and washing lines. Please consult with SMC regarding other types of applications.

Seal material: The durability of EPDM with respect to mineral oils is inferior, which makes it unsuitable for piping in general pneumatic equipment.

Particulate Generation Classification

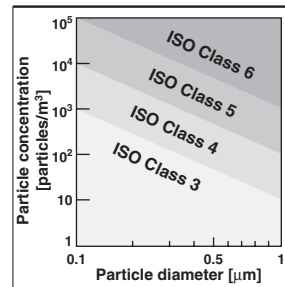

Note) For details, refer to the WEB catalogue at www.smc.eu

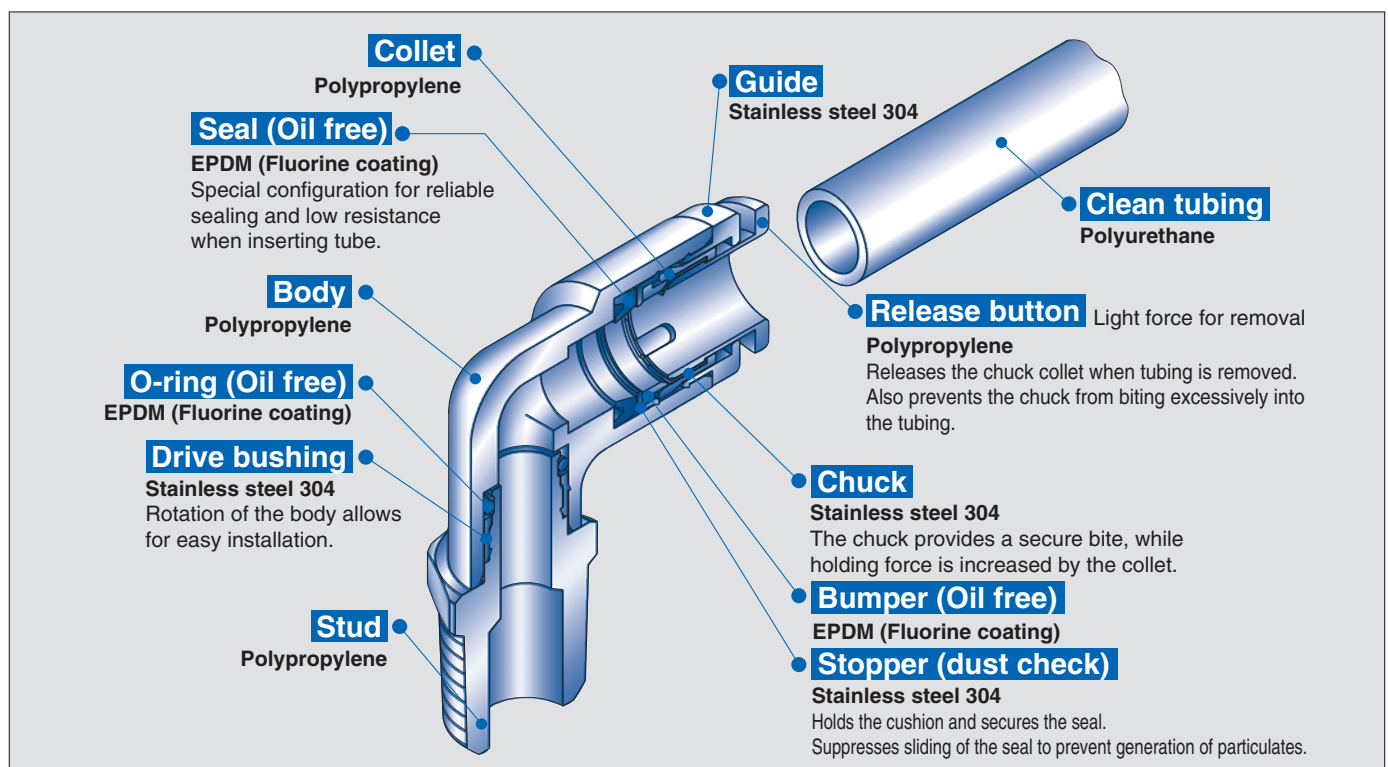

- KQ2
- KQ2-Uni
- KQB2
- KS/KX
- KM
- KF
- M
- H/DL L/L
- KC
- KK
- KKH
- KK 130
- DM
- DMK
- KDM
- MQR
- KB
- KR-W2
- KRM
- KA
- KQG2
- KG
- KFG2
- MS
- KKA
- KP
- KPQ/KPG
- LQ1
- LQ3
- LQHB

Male connector

KPH

Use to pipe in the same direction from female thread.
Most general style.

	Applicable tubing O.D. [mm]	Connection thread	Model
	Ø 4	R 1/8	KPH04-01
R 1/4		KPH04-02	
Ø 6	R 1/8	KPH06-01	
	R 1/4	KPH06-02	
Ø 8	R 1/8	KPH08-01	
	R 1/4	KPH08-02	
Ø 10	R 1/4	KPH10-02	
	R 3/8	KPH10-03	
Ø 12	R 3/8	KPH12-03	
	R 1/2	KPH12-04	

Male run tee

KPY

Use to branch line in the same direction from female thread and in 90° direction.

	Applicable tubing O.D. [mm]	Connection thread	Model
	Ø 4	R 1/8	KPY04-01
R 1/4		KPY04-02	
Ø 6	R 1/8	KPY06-01	
	R 1/4	KPY06-02	
Ø 8	R 1/8	KPY08-01	
	R 1/4	KPY08-02	
Ø 10	R 1/4	KPY10-02	
	R 3/8	KPY10-03	
Ø 12	R 3/8	KPY12-03	
	R 1/2	KPY12-04	

Male elbow

KPL

Use to pipe at right angles to female thread.
Most general style.

	Applicable tubing O.D. [mm]	Connection thread	Model
	Ø 4	R 1/8	KPL04-01
R 1/4		KPL04-02	
Ø 6	R 1/8	KPL06-01	
	R 1/4	KPL06-02	
Ø 8	R 1/8	KPL08-01	
	R 1/4	KPL08-02	
Ø 10	R 1/4	KPL10-02	
	R 3/8	KPL10-03	
Ø 12	R 3/8	KPL12-03	
	R 1/2	KPL12-04	

Branch

KPU

Use to branch line in the same direction from female thread.

	Applicable tubing O.D. [mm]	Connection thread	Model
	Ø 4	R 1/8	KPU04-01
R 1/4		KPU04-02	
Ø 6	R 1/8	KPU06-01	
	R 1/4	KPU06-02	
Ø 8	R 1/8	KPU08-01	
	R 1/4	KPU08-02	
Ø 10	R 1/4	KPU10-02	
	R 3/8	KPU10-03	
Ø 12	R 3/8	KPU12-03	
	R 1/2	KPU12-04	

Male branch tee

KPT

Use to branch line from female thread in both 90° directions.

	Applicable tubing O.D. [mm]	Connection thread	Model
	Ø 4	R 1/8	KPT04-01
R 1/4		KPT04-02	
Ø 6	R 1/8	KPT06-01	
	R 1/4	KPT06-02	
Ø 8	R 1/8	KPT08-01	
	R 1/4	KPT08-02	
Ø 10	R 1/4	KPT10-02	
	R 3/8	KPT10-03	
Ø 12	R 3/8	KPT12-03	
	R 1/2	KPT12-04	

Straight union

KPH

Use to connect tubes in the same direction.

	Applicable tubing O.D. [mm]	Model
	Ø 4	KPH04-00
Ø 6	KPH06-00	
Ø 8	KPH08-00	
Ø 10	KPH10-00	
Ø 12	KPH12-00	

Note) For dimensions and other details refer to specific catalogue of the series at www.smc.eu

Union elbow

KPL

Use to connect tubes at right angles.

	Applicable tubing O.D. [mm]	Model
	Ø 4	KPL04-00
Ø 6	KPL06-00	
Ø 8	KPL08-00	
Ø 10	KPL10-00	
Ø 12	KPL12-00	

Union tee

KPT

Use to connect tubes in both 90° directions.

	Applicable tubing O.D. [mm]	Model
	Ø 4	KPT04-00
Ø 6	KPT06-00	
Ø 8	KPT08-00	
Ø 10	KPT10-00	
Ø 12	KPT12-00	

Union "Y"

KPU

Use to branch line in the same direction.

	Applicable tubing O.D. [mm]	Model
	Ø 4	KPU04-00
Ø 6	KPU06-00	
Ø 8	KPU08-00	
Ø 10	KPU10-00	
Ø 12	KPU12-00	

Plug-in reducer

KPR

Use to size down One-touch fittings.

	Applicable tubing O.D. [mm]	Applicable fitting size	Model
	Ø 4	Ø 6	Ø 6
Ø 8			KPR04-08
Ø 6	Ø 8	Ø 8	KPR06-08
		Ø 10	KPR06-10
Ø 8	Ø 10	Ø 10	KPR08-10
		Ø 12	KPR08-12
Ø 10	Ø 12	Ø 12	KPR10-12

Plug

KPP

Use to plug unused One-touch fittings.

	Applicable fitting size	Model
	Ø 4	KPP-04
Ø 6	KPP-06	
Ø 8	KPP-08	
Ø 10	KPP-10	
Ø 12	KPP-12	

Note) For dimensions and other details refer to specific catalogue of the series at www.smc.eu



Made to Order

1 With Pipe Tape

Symbol	Specifications
X53	With pipe tape

Suffix "-X53" to the end of part number.
Example) **KPH04-01-X53**

- KQ2
- KQ2-Uni
- KQB2
- KS/KX
- KM
- KF
- M
- H/DL L/LL
- KC
- KK
- KKH
- KK 130
- DM
- DMK
- KDM
- MQR
- KB
- KR-W2
- KRM
- KA
- KQG2
- KG
- KFG2
- MS
- KKA
- KP**
- KPQ/KPG
- LQ1
- LQ3
- LQHB

Clean One-touch Fittings (for drive system air piping) RoHS

KPQ/KPG Series

■ Applicable tubing O.D. : **Metric Size**

■ Connection thread : **R**

Clean

Resin parts are P.P.
(Polypropylene)



Series **KPQ**



Series **KPG**

Recommended Applicable Tubing

Tubing material	PFA, Polyurethane
Tubing O.D.	Ø 4, Ø 6, Ø 8, Ø 10, Ø 12

FEP, nylon and soft nylon tubing, and tubing not compatible with the clean series can also be used. However, the degree of clean performance will be reduced.

Specifications

Cleanliness class (ISO)	Class 3 ^{Note 1)}
Fluid	Air
Maximum operating pressure (20 °C)	1 MPa ^{Note 2)}
Operating vacuum pressure	-100 kPa
Proof pressure (20 °C)	3 MPa
Ambient and fluid temperature	-5 °C to 60 °C
Thread	JIS B0203 (Taper thread for piping)
Lubricant	Fluorine-based grease

Note 1) Refer to particle generation classifications

This falls outside of the grade because fluorine grease is applied to the internal seal materials.

Note 2) The maximum operating pressure is the value at 20 °C. Refer to the operating pressure curve for other temperatures.

Note 3) Do not use the fittings with a leak tester or for vacuum retention because they are not guaranteed for zero leakage.

Particulate Generation Classification

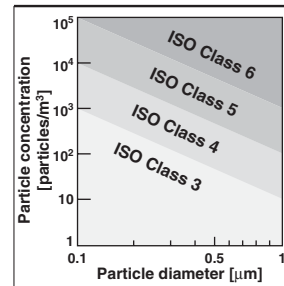

Note) For details, refer at the **WEB catalogue** at www.smc.eu

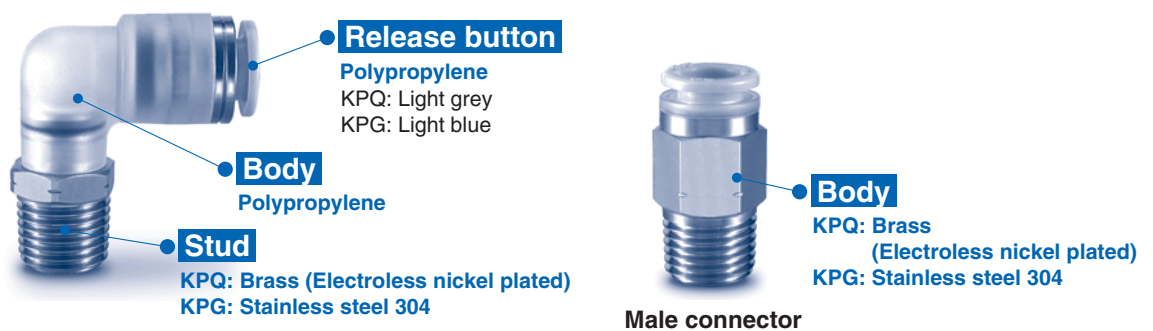

■ Drive air piping system

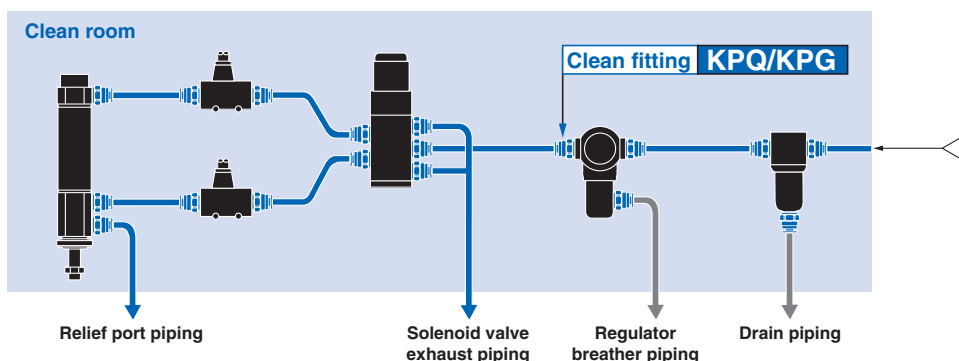

Male connector

KPQH/KPGH

Use to pipe in the same direction from female thread.
Most general style.

Applicable tubing O.D. [mm]	Connection thread	Model	
		KPQH	KPGH
Ø 4	M5 x 0.8	KPQH04-M5	KPGH04-M5
	R 1/8	KPQH04-01	KPGH04-01
	R 1/4	KPQH04-02	KPGH04-02
Ø 6	M5 x 0.8	KPQH06-M5	KPGH06-M5
	R 1/8	KPQH06-01	KPGH06-01
	R 1/4	KPQH06-02	KPGH06-02
Ø 8	R 1/8	KPQH08-01	KPGH08-01
	R 1/4	KPQH08-02	KPGH08-02
Ø 10	R 1/4	KPQH10-02	KPGH10-02
	R 3/8	KPQH10-03	KPGH10-03
Ø 12	R 3/8	KPQH12-03	KPGH12-03
	R 1/2	KPQH12-04	KPGH12-04

Male run tee

KPQY/KPGY

Use to branch line in the same direction from female thread and in 90° direction.

Applicable tubing O.D. [mm]	Connection thread	Model	
		KPQY	KPGY
Ø 4	M5 x 0.8	KPQY04-M5	KPGY04-M5
	R 1/8	KPQY04-01	KPGY04-01
	R 1/4	KPQY04-02	KPGY04-02
Ø 6	M5 x 0.8	KPQY06-M5	KPGY06-M5
	R 1/8	KPQY06-01	KPGY06-01
	R 1/4	KPQY06-02	KPGY06-02
Ø 8	R 1/8	KPQY08-01	KPGY08-01
	R 1/4	KPQY08-02	KPGY08-02
Ø 10	R 1/4	KPQY10-02	KPGY10-02
	R 3/8	KPQY10-03	KPGY10-03
Ø 12	R 3/8	KPQY12-03	KPGY12-03
	R 1/2	KPQY12-04	KPGY12-04

Male elbow

KPQL/KPGL

Use to pipe at right angles to female thread.
Most general style.

Applicable tubing O.D. [mm]	Connection thread	Model	
		KPQL	KPGL
Ø 4	M5 x 0.8	KPQL04-M5	KPGL04-M5
	R 1/8	KPQL04-01	KPGL04-01
	R 1/4	KPQL04-02	KPGL04-02
Ø 6	M5 x 0.8	KPQL06-M5	KPGL06-M5
	R 1/8	KPQL06-01	KPGL06-01
	R 1/4	KPQL06-02	KPGL06-02
Ø 8	R 1/8	KPQL08-01	KPGL08-01
	R 1/4	KPQL08-02	KPGL08-02
Ø 10	R 1/4	KPQL10-02	KPGL10-02
	R 3/8	KPQL10-03	KPGL10-03
Ø 12	R 3/8	KPQL12-03	KPGL12-03
	R 1/2	KPQL12-04	KPGL12-04

Branch

KPQU/KPGU

Use to branch line in the same direction from female thread.

Applicable tubing O.D. [mm]	Connection thread	Model	
		KPQU	KPGU
Ø 4	M5 x 0.8	KPQU04-M5	KPGU04-M5
	R 1/8	KPQU04-01	KPGU04-01
	R 1/4	KPQU04-02	KPGU04-02
Ø 6	M5 x 0.8	KPQU06-M5	KPGU06-M5
	R 1/8	KPQU06-01	KPGU06-01
	R 1/4	KPQU06-02	KPGU06-02
Ø 8	R 1/8	KPQU08-01	KPGU08-01
	R 1/4	KPQU08-02	KPGU08-02
Ø 10	R 1/4	KPQU10-02	KPGU10-02
	R 3/8	KPQU10-03	KPGU10-03
Ø 12	R 3/8	KPQU12-03	KPGU12-03
	R 1/2	KPQU12-04	KPGU12-04

Male branch tee

KPQT/KPGT

Use to branch line from female thread in both 90° directions.

Applicable tubing O.D. [mm]	Connection thread	Model	
		KPQT	KPGT
Ø 4	M5 x 0.8	KPQT04-M5	KPGT04-M5
	R 1/8	KPQT04-01	KPGT04-01
	R 1/4	KPQT04-02	KPGT04-02
Ø 6	M5 x 0.8	KPQT06-M5	KPGT06-M5
	R 1/8	KPQT06-01	KPGT06-01
	R 1/4	KPQT06-02	KPGT06-02
Ø 8	R 1/8	KPQT08-01	KPGT08-01
	R 1/4	KPQT08-02	KPGT08-02
Ø 10	R 1/4	KPQT10-02	KPGT10-02
	R 3/8	KPQT10-03	KPGT10-03
Ø 12	R 3/8	KPQT12-03	KPGT12-03
	R 1/2	KPQT12-04	KPGT12-04

Straight union

KPQH/KPGH

Use to connect tubes in the same direction.

Applicable tubing O.D. [mm]	Model	
	KPQH	KPGH
Ø 4	KPQH04-00	KPGH04-00
Ø 6	KPQH06-00	KPGH06-00
Ø 8	KPQH08-00	KPGH08-00
Ø 10	KPQH10-00	KPGH10-00
Ø 12	KPQH12-00	KPGH12-00

Note) For dimensions and other details refer to specific catalogue of the series at www.smc.eu

- KQ2
- KQ2-Uni
- KQB2
- KS/KX
- KM
- KF
- M
- H/DL L/LL
- KC
- KK
- KKH
- KK 130
- DM
- DMK
- KDM
- MQR
- KB
- KR-W2
- KRM
- KA
- KQG2
- KG
- KFG2
- MS
- KKA
- KP
- KPQ/KPG
- LQ1
- LQ3
- LQHB

Union elbow

KPQL/KPGL

Use to connect tubes at right angles.

	Applicable tubing O.D. [mm]	Model	
		KPQL	KPGL
	Ø 4	KPQL04-00	KPGL04-00
	Ø 6	KPQL06-00	KPGL06-00
	Ø 8	KPQL08-00	KPGL08-00
	Ø 10	KPQL10-00	KPGL10-00
	Ø 12	KPQL12-00	KPGL12-00

Plug-in reducer

KPQR/KPGR

Use to size down One-touch fittings.

	Applicable tubing O.D. [mm]	Applicable fitting size	Model	
			KPQR	KPGR
	Ø 4	Ø 6	KPQR04-06	KPGR04-06
		Ø 8	KPQR04-08	KPGR04-08
	Ø 6	Ø 8	KPQR06-08	KPGR06-08
		Ø 10	KPQR06-10	KPGR06-10
	Ø 8	Ø 10	KPQR08-10	KPGR08-10
		Ø 12	KPQR08-12	KPGR08-12
	Ø 10	Ø 12	KPQR10-12	KPGR10-12

Union tee

KPQT/KPGT

Use to connect tubes in both 90° directions.

	Applicable tubing O.D. [mm]	Model	
		KPQT	KPGT
	Ø 4	KPQT04-00	KPGT04-00
	Ø 6	KPQT06-00	KPGT06-00
	Ø 8	KPQT08-00	KPGT08-00
	Ø 10	KPQT10-00	KPGT10-00
	Ø 12	KPQT12-00	KPGT12-00

Plug

KPP

Use to plug unused One-touch fittings.

	Applicable fitting size	Model
	Ø 4	KPP-04
Ø 6	KPP-06	
Ø 8	KPP-08	
Ø 10	KPP-10	
Ø 12	KPP-12	

Union "Y"

KPQU/KPGU

Use to branch line in the same direction.

	Applicable tubing O.D. [mm]	Model	
		KPQU	KPGU
	Ø 4	KPQU04-00	KPGU04-00
	Ø 6	KPQU06-00	KPGU06-00
	Ø 8	KPQU08-00	KPGU08-00
	Ø 10	KPQU10-00	KPGU10-00
	Ø 12	KPQU12-00	KPGU12-00

Note) For dimensions and other details refer to specific catalogue of the series at www.smc.eu



Made to Order

1 With Pipe Tape

Symbol	Specifications
X53 ^(Note 1)	With pipe tape

Note) The following model is not available as made-to-order: Connection thread M5

2 Grease-free Specifications

Symbol	Specifications
X193 ^(Note 1)	Grease-free Rubber material: EPDM (Fluorine-coated) Gasket: M-5G3 (Stainless steel 316, Special FKM) ^{Note 2)} With release bushing, Guide colour: Natural

Note 1) Series KPG: Compatible with products with threads only Note 2) M5 thread

Fluoropolymer Fittings

LQ1 Series

■ Applicable tubing O.D. : Metric Size/Inch Sizes

■ Connection thread : R, Rc, NPT

Heat Resistant

Corrosion Resistant

Clean

Quadruple sealing construction

The quadruple sealing construction (PAT.) based on SMC's original idea results in highly reliable sealing characteristics with outstanding leakage prevention effect.

Locking

- Locking mechanism utilises sealing lock by the nut.
- Trapezoidal thread allows application of high torque.
- 2 stage pressing by the tubing holder of the nut ensures secure tube holding.

Flow-through characteristics

Excellent flow-through characteristics are achieved by minimizing liquid deposit.

Strong resistance to tube bending and deformation.

Able to withstand lateral loads with the tubing support.

Tubing sizes are interchangeable.

- The reducer method allows tubing size changes without replacing the body.
- Helps standardise fitting items resulting in less stock requirements.

Easy tightening of nuts.

- No positioning guide is required, simply tighten up the tubing to the end of the fitting body.
- The trapezoidal thread prevents oblique nut insertion.

For details about precautions and specifications, refer to the **WEB catalogue** at www.smc.eu

Specifications

Feature	Model	LQ1□10	LQ1□20	LQ1□30	LQ1□40	LQ1□50	LQ1□60
Material		NEW PFA					
Maximum operating pressure (at 20 °C)		1 MPa					
Proof pressure		Refer to the withstand pressure and heat resistance performance curves.					
Operating temperature		0 to 200 °C					

Burst Pressure and Heat Resistance Performance

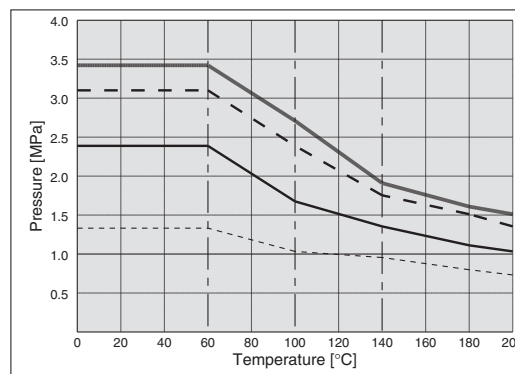

— 1/8", 3/16", 1/4", Ø 4, Ø 6 tubing
 - - 3/8", Ø 10 tubing
 — 1/2", Ø 12 tubing
 - - - 3/4", Ø 19, 1" tubing



Basic

2 stage pressing construction ensures sealing and tubing locking to absorb differences in the tube outside diameter.

D side sealing

A seal is formed when the tubing is inserted, with its insert bushing, and its compression against the internal nut.

Main sealing

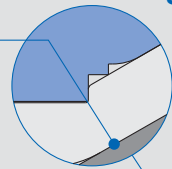

Sealing lock

Main sealing

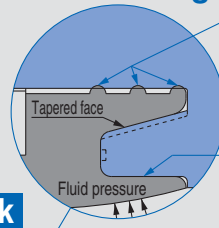

B side sealing

By tapering the face of the body, perfect sealing is achieved by the pressure of the bushing against the body wall (the protrusion of the insert bushing ensures that a secure high pressure seal is achieved).

A side sealing

The fluid pressure pushes the seal face to get effective sealing.

Tubing support

Trapezoidal thread

C side sealing

Sealed by the pressure exerted on the tubing by the internal nut.

Tubing connection

Union elbow reducing

LQ1E-R

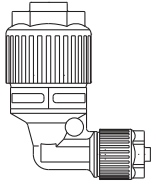

p. 159

Space saving union elbow reducing

LQ1E-SS-R

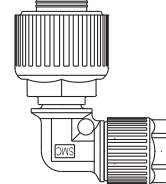

p. 161

Union tee reducing

LQ1T-R

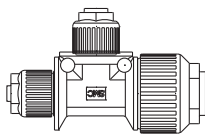

p. 160

Space saving union tee reducing

LQ1T-S-R

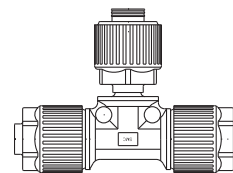

p. 162

Panel mount union reducing

LQ1P-R

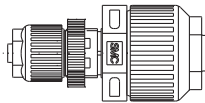

p. 161

Tubing extension union elbow

LQ1E-T

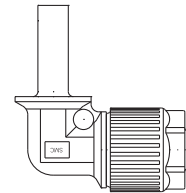

p. 163

Union reducing

LQ1U-R

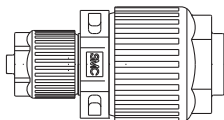

p. 161

Tubing extension union tee

LQ1T-TT

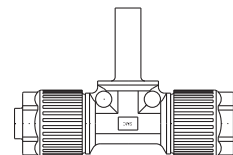

p. 163

Space saving union elbow

LQ1E-SS

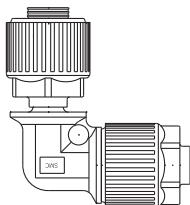

p. 161

Tubing extension union elbow reducing

LQ1E-T-R

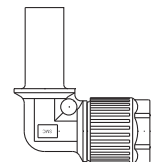

p. 164

Space saving union tee

LQ1T-ST

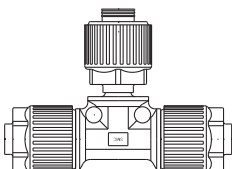

p. 162

Tubing extension union tee reducing

LQ1T-T-R

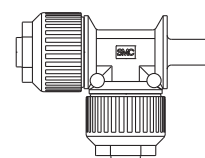

p. 164

Threaded connection

Connector

LQ1H

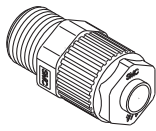

Male

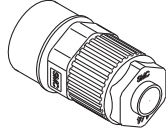

Female

P.165

Elbow

LQ1L

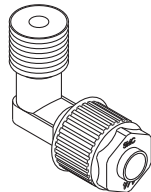

Male

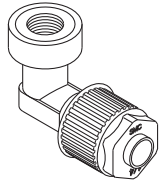

Female

P.166

Run tee

LQ1R

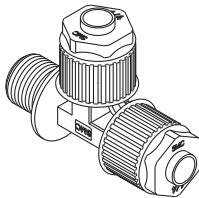

Male

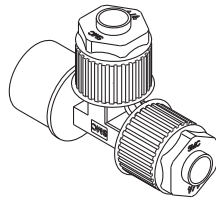

Female

P.167

Branch tee

LQ1B

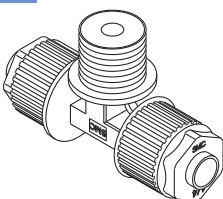

Male

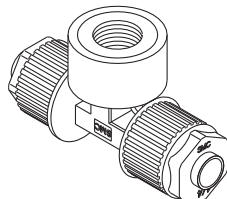

Female

P.168

Tubing connection

Union elbow

LQ1E

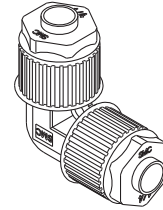

P.169

Union tee

LQ1T

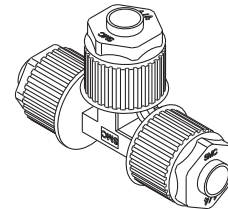

P.169

Panel mount union

LQ1P

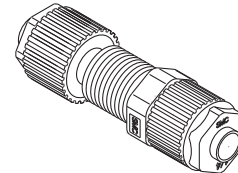

P.170

Union

LQ1U

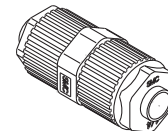

P.170

Union flange

LQ1F

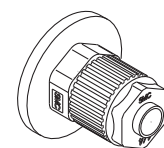

P.170

KQ2

KQ2
-Uni

KQB2

KS/
KX

KM

KF

M

H/DL
L/LL

KC

KK

KKH

KK
130

DM

DMK

KDM

MQR

KB

KR
-W2

KRM

KA

KQG2

KG

KFG2

MS

KKA

KP

KPQ/
KPG

LQ1

LQ3

LQHB

Union elbow reducing

LQ1E-R

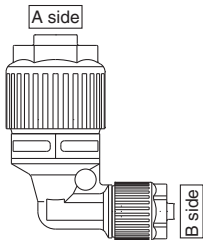

Metric size		
Applicable tubing O.D.		Model
A side	B side	
Ø 12	Ø 8	LQ1E41-R2
Ø 12	Ø 6	*LQ1E41-R3
Ø 12	Ø 4	*LQ1E41-R4
Ø 19	Ø 10	*LQ1E51-R2
Ø 19	Ø 8	*LQ1E51-R3
Ø 19	Ø 6	*LQ1E51-R4
Ø 19	Ø 4	*LQ1E51-R5
Ø 25	Ø 12	*LQ1E61-R2
Ø 25	Ø 10	*LQ1E61-R3
Ø 25	Ø 8	*LQ1E61-R4
Ø 25	Ø 6	*LQ1E61-R5
Inch size		
Applicable tubing O.D.		Model
A side	B side	
3/8"	1/8"	*LQ1E3A-R3
1/2"	1/4"	LQ1E4A-R2
1/2"	3/16"	*LQ1E4A-R3
1/2"	1/8"	*LQ1E4A-R4
3/4"	3/8"	*LQ1E5A-R2
3/4"	1/4"	*LQ1E5A-R3
3/4"	3/16"	*LQ1E5A-R4
1"	1/2"	*LQ1E6A-R2
1"	3/8"	*LQ1E6A-R3
1"	1/4"	*LQ1E6A-R4
1"	3/16"	*LQ1E6A-R5

* Products marked "*" are produced upon receipt of order. (The body of the fitting is PTFE machined.)

Note) For dimensions and other details refer to specific catalogue of the series at www.smc.eu

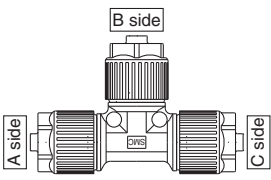
Union tee reducing
LQ1T-R

Metric size				Model
Applicable tubing O.D.				
A side	B side	C side		
Ø 10	Ø 3	Ø 10	LQ1T31-R4	
Ø 8	Ø 8	Ø 10	LQ1T31-R7	
Ø 6	Ø 6	Ø 10	LQ1T31-R8	
Ø 6	Ø 8	Ø 8	LQ1T32-R5	
Ø 6	Ø 10	Ø 10	LQ1T32-R6	
Ø 6	Ø 6	Ø 8	LQ1T32-R7	
Ø 12	Ø 8	Ø 12	LQ1T41-R2	
Ø 12	Ø 6	Ø 12	LQ1T41-R3	
Ø 10	Ø 12	Ø 12	LQ1T41-R5	
Ø 10	Ø 10	Ø 12	LQ1T41-R7	
Ø 6	Ø 10	Ø 12	LQ1T41-R11	
Ø 6	Ø 12	Ø 12	LQ1T41-R12	
Ø 10	Ø 6	Ø 12	LQ1T41-R22	
Ø 6	Ø 6	Ø 12	LQ1T41-R23	
Ø 12	Ø 3	Ø 12	LQ1T41-R26	
Ø 6	Ø 12	Ø 6	LQ1T41-R32	
Ø 3	Ø 12	Ø 3	LQ1T41-R34	
Ø 19	Ø 10	Ø 19	LQ1T51-R2	
Ø 19	Ø 8	Ø 19	LQ1T51-R3	
Ø 19	Ø 6	Ø 19	LQ1T51-R4	
Ø 12	Ø 19	Ø 19	LQ1T51-R5	
Ø 10	Ø 19	Ø 19	LQ1T51-R6	
Ø 12	Ø 12	Ø 19	*LQ1T51-R7	
Ø 10	Ø 10	Ø 19	*LQ1T51-R8	
Ø 10	Ø 19	Ø 10	LQ1T51-R10	
Ø 8	Ø 19	Ø 19	LQ1T51-R12	
Ø 6	Ø 19	Ø 19	LQ1T51-R13	
Ø 10	Ø 12	Ø 19	*LQ1T51-R17	
Ø 12	Ø 6	Ø 19	LQ1T51-R24	
Ø 19	Ø 4	Ø 19	LQ1T51-R26	
Ø 19	Ø 3	Ø 19	LQ1T51-R28	
Ø 10	Ø 19	Ø 12	LQ1T51-R31	
Ø 25	Ø 12	Ø 25	LQ1T61-R2	
Ø 25	Ø 10	Ø 25	LQ1T61-R3	
Ø 25	Ø 8	Ø 25	*LQ1T61-R4	
Ø 19	Ø 25	Ø 25	LQ1T61-R5	
Ø 12	Ø 25	Ø 25	LQ1T61-R6	
Ø 19	Ø 19	Ø 25	LQ1T61-R7	
Ø 12	Ø 12	Ø 19	*LQ1T61-R8	
Ø 12	Ø 25	Ø 12	LQ1T61-R10	
Ø 12	Ø 19	Ø 25	LQ1T61-R11	
Ø 10	Ø 25	Ø 25	LQ1T61-R12	
Ø 8	Ø 25	Ø 25	*LQ1T61-R13	
Ø 6	Ø 25	Ø 25	LQ1T61-R15	
Ø 10	Ø 19	Ø 25	LQ1T61-R18	
Ø 6	Ø 19	Ø 25	LQ1T61-R19	
Ø 19	Ø 12	Ø 25	LQ1T61-R20	
Ø 25	Ø 6	Ø 25	*LQ1T61-R26	
Ø 10	Ø 25	Ø 19	LQ1T61-R30	
Ø 12	Ø 25	Ø 19	LQ1T61-R31	
Ø 6	Ø 25	Ø 6	LQ1T61-R34	

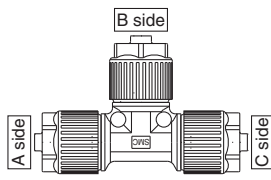
Union tee reducing
LQ1T-R

Inch size				Model
Applicable tubing O.D.				
A side	B side	C side		
1/4"	3/8"	3/8"	LQ1T3A-R5	
1/4"	1/4"	3/8"	LQ1T3A-R7	
1/2"	1/4"	1/2"	LQ1T4A-R2	
1/2"	1/8"	1/2"	LQ1T4A-R4	
3/8"	1/2"	1/2"	LQ1T4A-R5	
1/4"	1/2"	1/2"	LQ1T4A-R6	
3/8"	3/8"	1/2"	LQ1T4A-R7	
1/4"	1/4"	1/2"	LQ1T4A-R8	
1/4"	1/2"	1/4"	LQ1T4A-R10	
1/4"	3/8"	1/2"	LQ1T4A-R17	
3/8"	1/4"	1/2"	LQ1T4A-R20	
1/8"	1/2"	1/8"	LQ1T4A-R33	
3/4"	3/8"	3/4"	LQ1T5A-R2	
1/2"	3/4"	3/4"	LQ1T5A-R5	
3/8"	3/4"	3/4"	LQ1T5A-R6	
1/2"	1/2"	3/4"	*LQ1T5A-R7	
3/8"	3/8"	3/4"	LQ1T5A-R8	
3/8"	3/4"	3/8"	*LQ1T5A-R10	
1/4"	3/4"	3/4"	LQ1T5A-R12	
1/2"	3/8"	3/4"	*LQ1T5A-R17	
3/8"	1/4"	3/4"	LQ1T5A-R21	
1/2"	1/4"	3/4"	LQ1T5A-R22	
3/4"	1/8"	3/4"	LQ1T5A-R26	
3/8"	3/4"	1/2"	LQ1T5A-R31	
1/4"	3/4"	1/4"	*LQ1T5A-R32	
1"	1/2"	1"	LQ1T6A-R2	
1"	3/8"	1"	LQ1T6A-R3	
1"	1/4"	1"	*LQ1T6A-R4	
3/4"	1"	1"	LQ1T6A-R5	
1/2"	1"	1"	LQ1T6A-R6	
3/4"	3/4"	1"	LQ1T6A-R7	
1/2"	1/2"	1"	*LQ1T6A-R8	
1/2"	1"	1/2"	LQ1T6A-R10	
3/8"	3/4"	1"	LQ1T6A-R11	
3/8"	1"	1"	LQ1T6A-R12	
1/4"	1"	1"	*LQ1T6A-R13	
1/2"	3/4"	1"	LQ1T6A-R17	
1/4"	3/4"	1"	*LQ1T6A-R18	
3/4"	1/2"	1"	LQ1T6A-R20	
3/8"	1"	3/4"	LQ1T6A-R30	
1/2"	1"	3/4"	LQ1T6A-R31	
1/4"	1"	1/4"	*LQ1T6A-R33	

* Products marked "*" are produced upon receipt of order. (The body of the fitting is PTFE machined.)

Note) For dimensions and other details refer to specific catalogue of the series at www.smc.eu

- KQ2
- KQ2-Uni
- KQB2
- KS/KX
- KM
- KF
- M
- H/DL L/LL
- KC
- KK
- KKH
- KK130
- DM
- DMK
- KDM
- MQR
- KB
- KR-W2
- KRM
- KA
- KQG2
- KG
- KFG2
- MS
- KKA
- KP
- KPQ/KPG
- LQ1
- LQ3
- LQHB

Panel mount union reducing

LQ1P-R

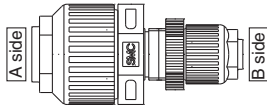

Metric size		
Applicable tubing O.D.		Model
A side	B side	
Ø 12	Ø 6	*LQ1P41-R3
Ø 19	Ø 10	*LQ1P51-R2
Inch size		
Applicable tubing O.D.		Model
A side	B side	
1/2"	1/4"	*LQ1P4A-R2
3/4"	3/8"	*LQ1P5A-R2

* Products marked "*" are produced upon receipt of order. (The body of the fitting is PTFE machined.)

Union reducing

LQ1U-R

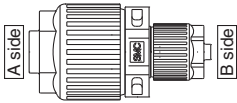

Metric size		
Applicable tubing O.D.		Model
A side	B side	
Ø 10	Ø 4	LQ1U31-R3
Ø 10	Ø 3	LQ1U31-R4
Ø 12	Ø 8	LQ1U41-R2
Ø 12	Ø 6	LQ1U41-R3
Ø 12	Ø 4	LQ1U41-R4
Ø 12	Ø 3	LQ1U41-R5
Ø 19	Ø 10	*LQ1U51-R2
Ø 19	Ø 8	*LQ1U51-R3
Ø 19	Ø 6	LQ1U51-R4
Ø 19	Ø 4	LQ1U51-R5
Ø 19	Ø 3	LQ1U51-R6
Ø 25	Ø 12	LQ1U61-R2
Ø 25	Ø 10	LQ1U61-R3
Ø 25	Ø 6	*LQ1U61-R5
Inch size		
Applicable tubing O.D.		Model
A side	B side	
1/2"	1/4"	LQ1U4A-R2
1/2"	3/16"	LQ1U4A-R3
1/2"	1/8"	LQ1U4A-R4
3/4"	3/8"	*LQ1U5A-R2
3/4"	1/4"	LQ1U5A-R3
3/4"	3/16"	LQ1U5A-R4
3/4"	1/8"	LQ1U5A-R5
1"	1/2"	LQ1U6A-R2
1"	3/8"	LQ1U6A-R3
1"	1/4"	*LQ1U6A-R4

* Products marked "*" are produced upon receipt of order. (The body of the fitting is PTFE machined.)

Note) For dimensions and other details refer to specific catalogue of the series at www.smc.eu

Space saving union elbow

LQ1E-SS

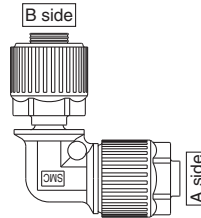

Metric size		
Applicable tubing O.D.	Applicable body size	Model
A side	B side	
Ø 6	2	LQ1E21-SS
Ø 10	3	LQ1E31-SS
Ø 8	3	LQ1E32-SS
Ø 12	4	LQ1E41-SS
Ø 19	5	*LQ1E51-SS
Ø 25	6	LQ1E61-SS
Inch size		
Applicable tubing O.D.	Applicable body size	Model
A side	B side	
1/4"	2	LQ1E2A-SS
3/8"	3	LQ1E3A-SS
1/2"	4	LQ1E4A-SS
3/4"	5	*LQ1E5A-SS
1"	6	LQ1E6A-SS

* Products marked "*" are produced upon receipt of order. (The body of the fitting is PTFE machined.)

Space saving union elbow reducing

LQ1E-SS-R

Residual Pressure Exhaust

Metric size		
Applicable tubing O.D.	Applicable body size	Model
A side	B side	
Ø 6	3	*LQ1E21-SS-R9
	4	*LQ1E21-SS-R10
Ø 10	2	*LQ1E31-SS-R2
	4	*LQ1E31-SS-R8
Ø 8	2	*LQ1E32-SS-R1
	3	LQ1E32-SS-R8
Ø 12	3	*LQ1E41-SS-R1
	2	LQ1E41-SS-R3
	5	*LQ1E41-SS-R8
Ø 25	5	LQ1E61-SS-R1
Inch size		
Applicable tubing O.D.	Applicable body size	Model
A side	B side	
1/4"	3	*LQ1E2A-SS-R8
	4	*LQ1E2A-SS-R9
3/8"	2	*LQ1E3A-SS-R1
	4	*LQ1E3A-SS-R8
1/2"	3	*LQ1E4A-SS-R1
	2	LQ1E4A-SS-R2
	5	*LQ1E4A-SS-R8
1"	5	LQ1E6A-SS-R1

* Products marked "*" are produced upon receipt of order. (The body of the fitting is PTFE machined.)

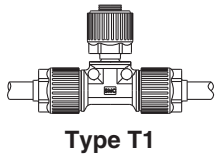
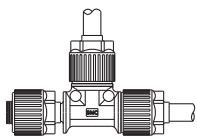
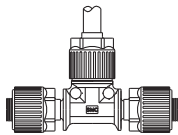
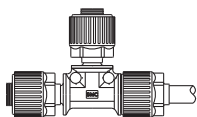
Space saving union tee
LQ1T-ST

Type T1

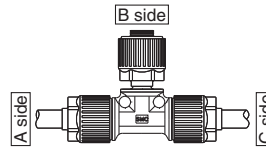
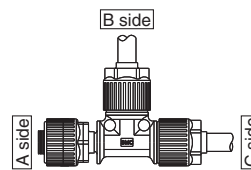
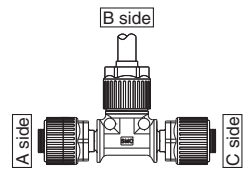
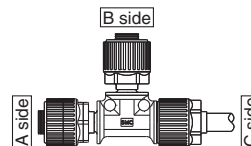
Type T2

Type T3

Type T4

Metric size	
Applicable tubing O.D.	Model
ø6	LQ1T21-ST1
	LQ1T21-ST2
	LQ1T21-ST3
	LQ1T21-ST4
ø10	LQ1T31-ST1
	LQ1T31-ST2
	LQ1T31-ST3
	LQ1T31-ST4
ø8	LQ1T32-ST1
	LQ1T32-ST2
	LQ1T32-ST3
	LQ1T32-ST4
ø12	LQ1T41-ST1
	LQ1T41-ST2
	LQ1T41-ST3
	LQ1T41-ST4
ø19	LQ1T51-ST1
	LQ1T51-ST2
	LQ1T51-ST3
	LQ1T51-ST4
ø25	LQ1T61-ST1
	LQ1T61-ST2
	LQ1T61-ST3
	LQ1T61-ST4
Inch size	
Applicable tubing O.D.	Model
1/4"	LQ1T2A-ST1
	LQ1T2A-ST2
	LQ1T2A-ST3
	LQ1T2A-ST4
3/8"	LQ1T3A-ST1
	LQ1T3A-ST2
	LQ1T3A-ST3
	LQ1T3A-ST4
1/2"	LQ1T4A-ST1
	LQ1T4A-ST2
	LQ1T4A-ST3
	LQ1T4A-ST4
3/4"	LQ1T5A-ST1
	LQ1T5A-ST2
	LQ1T5A-ST3
	LQ1T5A-ST4
1"	LQ1T6A-ST1
	LQ1T6A-ST2
	LQ1T6A-ST3
	LQ1T6A-ST4

Space saving union tee reducing
LQ1T-S-R

Type T1

Type T2

Type T3

Type T4

Metric size			
Applicable tubing O.D.			Model
A side (Left)	B side (Center)	C side (Right)	
ø6	Body size 3	ø6	LQ1T21-ST1-R39
Body size 3	ø6	ø6	LQ1T21-ST2-R41
ø8	Body size 3	ø8	LQ1T32-ST1-R37
Body size 3	ø8	ø8	LQ1T32-ST2-R40
ø12	Body size 3	ø12	*LQ1T41-ST1-R1
ø12	Body size 5	ø12	*LQ1T41-ST1-R37
ø19	Body size 4	ø19	*LQ1T51-ST1-R1
ø19	Body size 3	ø19	*LQ1T51-ST1-R2
ø12	Body size 5	ø19	LQ1T51-ST1-R5
ø6	Body size 5	ø19	*LQ1T51-ST1-R13
ø12	Body size 6	ø19	*LQ1T51-ST1-R36
ø19	Body size 6	ø12	*LQ1T51-ST1-R37
Body size 5	ø6	ø19	LQ1T51-ST2-R4
ø25	Body size 5	ø25	*LQ1T61-ST1-R1
ø25	Body size 4	ø25	*LQ1T61-ST1-R2
Body size 6	ø19	ø25	LQ1T61-ST2-R1
Inch size			
Applicable tubing O.D.			Model
A side (Left)	B side (Center)	C side (Right)	
Body size 3	3/8	1/4	LQ1T3A-ST2-R5
1/2	Body size 3	1/2	*LQ1T4A-ST1-R1
3/8	Body size 3	1/2	*LQ1T4A-ST1-R7
1/2	Body size 5	1/2	*LQ1T4A-ST1-R37
3/4	Body size 4	3/4	*LQ1T5A-ST1-R1
3/4	Body size 3	3/4	*LQ1T5A-ST1-R2
1/2	Body size 5	3/4	LQ1T5A-ST1-R5
1/2	Body size 4	3/4	LQ1T5A-ST1-R7
1/4	Body size 5	3/4	*LQ1T5A-ST1-R12
Body size 4	3/4	3/4	*LQ1T5A-ST2-R1
Body size 5	1/4	3/4	LQ1T5A-ST2-R3
Body size 4	3/4	Body size 4	*LQ1T5A-ST3-R5
1	Body size 5	1	*LQ1T6A-ST1-R1
1	Body size 4	1	*LQ1T6A-ST1-R2
1	Body size 3	1	*LQ1T6A-ST1-R3
Body size 6	3/4	1	LQ1T6A-ST2-R1
Body size 6	3/4	3/4	LQ1T6A-ST2-R2

* Products marked "*" are produced upon receipt of order. (The body of the fitting is PTFE machined.)

Note) For dimensions and other details refer to specific catalogue of the series at www.smc.eu

 KQ2
 KQ2 Uni
 QB2
 KS/KX
 KM
 KF
 M
 W/DL
 L/LL
 KC
 KK
 KKH
 KK 30
 DM
 DMK
 KDM
 MQR
 KB
 KR
 W2
 KRM
 KA
 QG2
 KG
 FG2
 MS
 KKA
 KP
 PQ/PG
 Q1
 Q3
 LQHB

Tubing extension union elbow

LQ1E-T

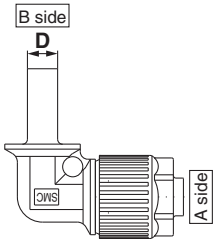

Metric size		
Applicable tubing O.D.	Tubing size (D)	Model
A side	B side	
ø6	6 x 4	LQ1E21-T
ø10	10 x 8	LQ1E31-T
ø8	8 x 6	LQ1E32-T
ø12	12 x 10	LQ1E41-T
ø19	19 x 16	*LQ1E51-T
ø25	25 x 22	LQ1E61-T
Inch size		
Applicable tubing O.D.	Tubing size (D)	Model
A side	B side	
1/4"	1/4" x 5/32"	LQ1E2A-T
3/8"	3/8" x 1/4"	LQ1E3A-T
1/2"	1/2" x 3/8"	LQ1E4A-T
3/4"	3/4" x 5/8"	*LQ1E5A-T
1"	1" x 7/8"	LQ1E6A-T

* Products marked "*" are produced upon receipt of order. (The body of the fitting is PTFE machined.)

Tubing extension union tee

LQ1T-TT

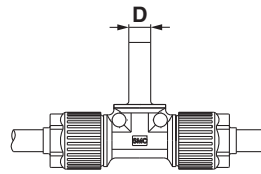

Type T1

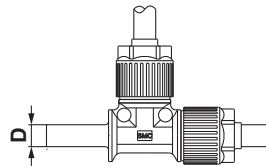

Type T2

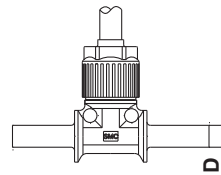

Type T3

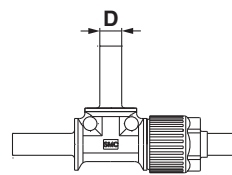

Type T4

Metric size		
Applicable tubing O.D.	Tubing size (D)	Model
ø6	6 x 4	*LQ1T21-TT1
		*LQ1T21-TT2
ø10	10 x 8	*LQ1T31-TT1
		*LQ1T31-TT2
ø8	8 x 6	*LQ1T32-TT1
		*LQ1T32-TT2
		*LQ1T32-TT3
ø12	10 x 8	*LQ1T41-TT1
		*LQ1T41-TT2
		*LQ1T41-TT3
ø19	19 x 16	LQ1T51-TT1
		LQ1T51-TT2
		LQ1T51-TT3
		LQ1T51-TT4
ø25	25 x 22	LQ1T61-TT1
		LQ1T61-TT2
		LQ1T61-TT3
		LQ1T61-TT4
Inch size		
Applicable tubing O.D.	Tubing size (D)	Model
1/4"	1/4" x 5/32"	LQ1T2A-TT1
		LQ1T2A-TT2
		LQ1T2A-TT3
		LQ1T2A-TT4
3/8"	3/8" x 1/4"	LQ1T3A-TT1
		LQ1T3A-TT2
		LQ1T3A-TT3
		LQ1T3A-TT4
1/2"	1/2" x 3/8"	LQ1T4A-TT1
		LQ1T4A-TT2
		LQ1T4A-TT3
		LQ1T4A-TT4
3/4"	3/4" x 5/8"	LQ1T5A-TT1
		LQ1T5A-TT2
		LQ1T5A-TT3
		LQ1T5A-TT4
1"	1" x 7/8"	LQ1T6A-TT1
		LQ1T6A-TT2
		LQ1T6A-TT3
		LQ1T6A-TT4

* Products marked "*" are produced upon receipt of order. (The body of the fitting is PTFE machined.)

Note) For dimensions and other details refer to specific catalogue of the series at www.smc.eu

Tubing extension union elbow reducing

LQ1E-T-R

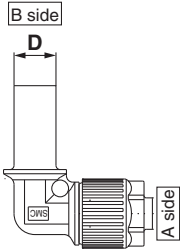

Metric size		
Applicable tubing O.D.	Tubing size (D)	Model
A side	B side	
ø6	8 x 6	LQ1E21-T-R8
	10 x 8	LQ1E21-T-R9
	12 x 10	LQ1E21-T-R10
ø4	6 x 4	LQ1E22-T-R8
	8 x 6	LQ1E22-T-R9
	10 x 8	LQ1E22-T-R10
	12 x 10	LQ1E22-T-R11
ø10	8 x 6	LQ1E31-T-R1
	6 x 4	LQ1E31-T-R2
	12 x 10	LQ1E31-T-R8
	19 x 16	*LQ1E31-T-R9
ø8	6 x 4	LQ1E32-T-R1
	10 x 8	LQ1E32-T-R8
	12 x 10	LQ1E32-T-R9
	19 x 16	*LQ1E32-T-R10
ø12	10 x 8	LQ1E41-T-R1
	8 x 6	LQ1E41-T-R2
	6 x 4	LQ1E41-T-R3
	19 x 16	*LQ1E41-T-R8
	25 x 22	*LQ1E41-T-R9
ø19	25 x 22	*LQ1E51-T-R8
ø25	19 x 16	LQ1E61-T-R1
Inch size		
Applicable tubing O.D.	Tubing size (D)	Model
A side	B side	
1/4"	3/8" x 1/4"	*LQ1E2A-T-R8
	1/2" x 3/8"	*LQ1E2A-T-R9
3/8"	1/4" x 5/32"	*LQ1E3A-T-R1
	1/2" x 3/8"	*LQ1E3A-T-R8
	3/4" x 5/8"	*LQ1E3A-T-R9
1/2"	3/8" x 1/4"	*LQ1E4A-T-R1
	3/4" x 5/8"	*LQ1E4A-T-R8
	1" x 7/8"	*LQ1E4A-T-R9
3/4"	1" x 7/8"	*LQ1E5A-T-R8
1"	3/4" x 5/8"	LQ1E6A-T-R1

* Products marked "*" are produced upon receipt of order. (The body of the fitting is PTFE machined.)

Tubing extension union tee reducing

LQ1T-T-R

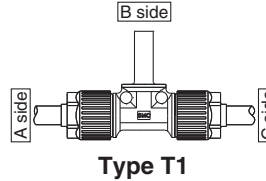

Type T1

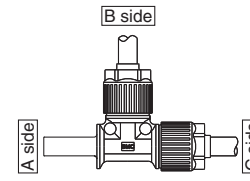

Type T2

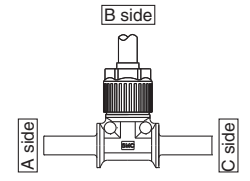

Type T3

Metric size			
Applicable tubing O.D.			Model
A side (Left)	B side (Center)	C side (Right)	
ø6	Tube ø10	ø6	*LQ1T21-TT1-R39
Tube ø10	ø6	ø6	*LQ1T21-TT2-R41
ø8	Tube ø10	ø8	*LQ1T32-TT1-R37
Tube ø10	ø8	ø8	*LQ1T32-TT2-R40
ø12	Tube ø10	ø12	*LQ1T41-TT1-R1
ø12	Tube ø19	ø12	*LQ1T41-TT1-R37
ø19	Tube ø12	ø19	*LQ1T51-TT1-R1
ø19	Tube ø10	ø19	*LQ1T51-TT1-R2
ø12	Tube ø19	ø19	LQ1T51-TT1-R5
ø6	Tube ø19	ø19	*LQ1T51-TT1-R13
ø19	Tube ø25	ø19	LQ1T51-TT1-R37
ø6	Tube ø25	ø19	*LQ1T51-TT1-R38
Tube ø19	ø6	ø19	LQ1T51-TT2-R4
ø25	Tube ø19	ø25	*LQ1T61-TT1-R1
ø25	Tube 1/2	ø25	*LQ1T61-TT1-R2
Tube ø25	ø19	ø25	LQ1T61-TT2-R1
Inch size			
Applicable tubing O.D.			Model
A side (Left)	B side (Center)	C side (Right)	
Tube 3/8	3/8	1/4	LQ1T3A-TT2-R5
1/2	Tube 3/8	1/2	*LQ1T4A-TT1-R1
3/8	Tube 3/8	1/2	*LQ1T4A-TT1-R7
1/2	Tube 3/4	1/2	*LQ1T4A-TT1-R37
3/4	Tube 1/2	3/4	*LQ1T5A-TT1-R1
3/4	Tube 3/8	3/4	*LQ1T5A-TT1-R2
1/4	Tube 3/4	3/4	*LQ1T5A-TT1-R3
1/2	Tube 3/4	3/4	LQ1T5A-TT1-R5
1/2	Tube 1/2	3/4	LQ1T5A-TT1-R7
Tube 3/4	1/4	3/4	LQ1T5A-TT2-R4
Tube 1	3/4	3/4	*LQ1T5A-TT2-R40
Tube 3/4	3/4	Tube 1/2	LQ1T5A-TT3-R5
Tube 1/2	3/4	Tube 1/2	*LQ1T5A-TT3-R7
ø25	Tube 3/4	ø25	*LQ1T6A-TT1-R1
ø25	Tube 1/2	ø25	*LQ1T6A-TT1-R2
ø25	Tube 3/8	ø25	*LQ1T6A-TT1-R3
Tube 1	ø19	ø25	LQ1T6A-TT2-R1

* Products marked "*" are produced upon receipt of order. (The body of the fitting is PTFE machined.)

Note) For dimensions and other details refer to specific catalogue of the series at www.smc.eu

KQ2
 KQ2 Uni
 QB2
 KS/KX
 KM
 KF
 M
 W/DL
 W/LL
 KC
 KK
 KKH
 KK 30
 DM
 DMK
 KDM
 MQR
 KB
 KR W2
 KRM
 KA
 QG2
 KG
 FG2
 MS
 KKA
 KP
 KPQ/PG
 LQ1
 LQ3
 LQHB

Male connector

LQ1H-M

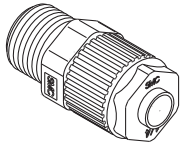

Enter the thread type in □.

—	R, Rc
N	NPT

Metric sizes		
Applicable tubing O.D.	Connection thread R, NPT	Model
Ø 4	1/8"	LQ1H11-M□
Ø 3		LQ1H12-M□
Ø 6		LQ1H21-M□
Ø 4	1/8"	LQ1H22-M□
Ø 3		LQ1H2C-M□
Ø 6		LQ1H23-M□
Ø 4	1/4"	LQ1H24-M□
Ø 3		LQ1H2F-M□
Ø 10		LQ1H31-M□
Ø 8	1/4"	LQ1H32-M□
Ø 6		LQ1H33-M□
Ø 10		LQ1H34-M□
Ø 8	3/8"	LQ1H35-M□
Ø 6		LQ1H36-M□
Ø 4		LQ1H37-M□
Ø 3	1/8"	LQ1H3E-M□
Ø 10		LQ1H39-M□
Ø 8		LQ1H310-M□
Ø 12	3/8"	LQ1H41-M□
Ø 10		LQ1H42-M□
Ø 12		LQ1H43-M□
Ø 10	1/2"	LQ1H44-M□
Ø 8		LQ1H45-M□
Ø 6		LQ1H46-M□
Ø 3	1/4"	LQ1H4F-M□
Ø 12		LQ1H49-M□
Ø 19		LQ1H51-M□
Ø 12	1/2"	LQ1H52-M□
Ø 19		LQ1H53-M□
Ø 12		LQ1H54-M□
Ø 10	3/4"	LQ1H55-M□
Ø 6		LQ1H57-M□
Ø 19		LQ1H58-M□
Ø 19	3/8"	LQ1H59-M□
Ø 25		LQ1H61-M□
Ø 19		LQ1H62-M□
Ø 25	1"	LQ1H63-M□
Ø 19		LQ1H64-M□
Ø 12		LQ1H65-M□
Ø 25	1/2"	LQ1H66-M□
1/8"		LQ1H1A-M□
1/4"		LQ1H2A-M□
3/16"	1/8"	LQ1H2B-M□
1/8"		LQ1H2C-M□
1/4"		LQ1H2D-M□
3/16"	1/4"	LQ1H2E-M□
1/8"		LQ1H2F-M□
3/8"		LQ1H3A-M□
1/4"	1/4"	LQ1H3B-M□
3/8"		LQ1H3C-M□
1/4"		LQ1H3D-M□
1/8"	3/8"	LQ1H3E-M□
3/8"		LQ1H3F-M□
1/2"		LQ1H4A-M□
3/8"	3/8"	LQ1H4B-M□
1/2"		LQ1H4C-M□
3/8"		LQ1H4D-M□
1/4"	1/2"	LQ1H4E-M□
1/8"		LQ1H4F-M□
1/2"		LQ1H4G-M□
3/4"	1/2"	LQ1H5A-M□
1/2"		LQ1H5B-M□
3/4"		LQ1H5C-M□
1/2"	3/4"	LQ1H5D-M□
3/8"		LQ1H5E-M□
1/4"		LQ1H5F-M□
3/4"	1/4"	LQ1H5G-M□
1"		LQ1H5H-M□
3/4"		LQ1H6A-M□
1"	3/4"	LQ1H6B-M□
3/4"		LQ1H6C-M□
1/2"		LQ1H6D-M□
1/2"	1"	LQ1H6E-M□
1"		LQ1H6F-M□

Female connector

LQ1H-F

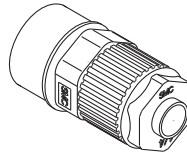

Enter the thread type in □.

—	R, Rc
N	NPT

Metric sizes		
Applicable tubing O.D.	Connection thread Rc, NPT	Model
Ø 4	1/8"	LQ1H11-F□
Ø 3		LQ1H12-F□
Ø 6		LQ1H21-F□
Ø 4	1/8"	LQ1H22-F□
Ø 3		LQ1H2C-F□
Ø 6		LQ1H23-F□
Ø 4	1/4"	LQ1H24-F□
Ø 3		LQ1H2F-F□
Ø 10		LQ1H31-F□
Ø 8	1/4"	LQ1H32-F□
Ø 6		LQ1H33-F□
Ø 10		LQ1H34-F□
Ø 8	3/8"	LQ1H35-F□
Ø 6		LQ1H36-F□
Ø 10		LQ1H39-F□
Ø 8	1/8"	LQ1H310-F□
Ø 12		LQ1H41-F□
Ø 10		LQ1H42-F□
Ø 12	3/8"	LQ1H43-F□
Ø 10		LQ1H44-F□
Ø 8		LQ1H45-F□
Ø 6	1/2"	LQ1H46-F□
Ø 12		LQ1H49-F□
Ø 19		LQ1H51-F□
Ø 12	1/4"	LQ1H52-F□
Ø 19		LQ1H53-F□
Ø 12		LQ1H54-F□
Ø 19	1/8"	LQ1H55-F□
Ø 6		LQ1H57-F□
Ø 19		LQ1H58-F□
Ø 19	3/8"	LQ1H59-F□
Ø 25		LQ1H61-F□
Ø 19		LQ1H62-F□
Ø 25	1"	LQ1H63-F□
Ø 19		LQ1H64-F□
Ø 19		LQ1H65-F□
1/8"	1/8"	LQ1H1A-F□
1/4"		LQ1H2A-F□
3/16"		LQ1H2B-F□
1/8"	1/8"	LQ1H2C-F□
1/4"		LQ1H2D-F□
3/16"		LQ1H2E-F□
1/8"	1/4"	LQ1H2F-F□
3/8"		LQ1H3A-F□
1/4"		LQ1H3B-F□
3/8"	3/8"	LQ1H3C-F□
1/4"		LQ1H3D-F□
1/8"		LQ1H3E-F□
3/8"	1/8"	LQ1H3F-F□
1/2"		LQ1H4A-F□
3/8"		LQ1H4B-F□
1/2"	3/8"	LQ1H4C-F□
3/8"		LQ1H4D-F□
1/4"		LQ1H4E-F□
1/2"	1/2"	LQ1H4F-F□
3/4"		LQ1H4G-F□
1/2"		LQ1H4H-F□
3/4"	1/2"	LQ1H5A-F□
1/2"		LQ1H5B-F□
3/4"		LQ1H5C-F□
1/2"	3/4"	LQ1H5D-F□
3/4"		LQ1H5E-F□
1/2"		LQ1H5F-F□
3/4"	1/4"	LQ1H5G-F□
1"		LQ1H5H-F□
3/4"		LQ1H6A-F□
1"	3/4"	LQ1H6B-F□
3/4"		LQ1H6C-F□
1"		LQ1H6D-F□

Note) For dimensions and other details refer to specific catalogue of the series at www.smc.eu

Male elbow

LQ1L-M

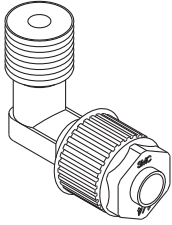

Enter the thread type in □.

—	R, Rc
N	NPT

Metric sizes		
Applicable tubing O.D.	Connection thread R, NPT	Model
Ø 4	1/8"	LQ1L11-M□
Ø 3		LQ1L12-M□
Ø 6		LQ1L21-M□
Ø 4	1/8"	LQ1L22-M□
Ø 3		LQ1L2C-M□
Ø 6		LQ1L23-M□
Ø 4	1/4"	LQ1L24-M□
Ø 3		LQ1L2F-M□
Ø 10		LQ1L31-M□
Ø 8	1/4"	LQ1L32-M□
Ø 6		LQ1L33-M□
Ø 10		LQ1L34-M□
Ø 8	3/8"	LQ1L35-M□
Ø 6		LQ1L36-M□
Ø 4		LQ1L37-M□
Ø 3	3/8"	LQ1L3E-M□
Ø 10		LQ1L39-M□
Ø 8		LQ1L310-M□
Ø 12	3/8"	LQ1L41-M□
Ø 10		LQ1L42-M□
Ø 12		LQ1L43-M□
Ø 10	1/2"	LQ1L44-M□
Ø 8		LQ1L45-M□
Ø 6		LQ1L46-M□
Ø 4	1/2"	*LQ1L47-M□
Ø 3		*LQ1L4F-M□
Ø 12		LQ1L49-M□
Ø 19	1/4"	LQ1L51-M□
Ø 12	1/2"	LQ1L52-M□
Ø 19		LQ1L53-M□
Ø 12		LQ1L54-M□
Ø 10	3/4"	LQ1L55-M□
Ø 8		LQ1L56-M□
Ø 6		LQ1L57-M□
Ø 19	3/8"	*LQ1L59-M□
Ø 25	3/4"	LQ1L61-M□
Ø 19		LQ1L62-M□
Ø 25		LQ1L63-M□
Ø 19	1"	LQ1L64-M□
Ø 12		LQ1L65-M□
Ø 25		LQ1L67-M□
Ø 8	3/8"	*LQ1L67-M□
Inch sizes		
Applicable tubing O.D.	Connection thread R, NPT	Model
1/8"	1/8"	LQ1L1A-M□
1/4"		LQ1L2A-M□
3/16"		LQ1L2B-M□
1/8"	1/8"	LQ1L2C-M□
1/4"		LQ1L2D-M□
3/16"		LQ1L2E-M□
1/8"	1/4"	LQ1L2F-M□
3/8"		LQ1L3A-M□
1/4"		LQ1L3B-M□
3/8"	1/4"	LQ1L3C-M□
1/4"		LQ1L3D-M□
1/8"		LQ1L3E-M□
3/8"	1/8"	LQ1L3F-M□
1/2"		LQ1L4A-M□
3/8"		LQ1L4B-M□
1/2"	3/8"	LQ1L4C-M□
3/8"		LQ1L4D-M□
1/4"		LQ1L4E-M□
1/8"	1/2"	*LQ1L4F-M□
1/2"		LQ1L4G-M□
3/4"		LQ1L5A-M□
1/2"	1/2"	LQ1L5B-M□
3/4"		LQ1L5C-M□
1/2"		LQ1L5D-M□
3/8"	3/4"	LQ1L5E-M□
1/4"		LQ1L5F-M□
3/4"		*LQ1L5H-M□
1"	3/4"	LQ1L6A-M□
3/4"		LQ1L6B-M□
1"		LQ1L6C-M□
3/4"	1"	LQ1L6D-M□
1/2"		LQ1L6E-M□
1"		*LQ1L6G-M□

Note) Products marked "*" are produced upon receipt of order. (The body of the fitting is PTFE machined.)

Female elbow

LQ1L-F

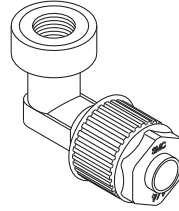

Enter the thread type in □.

—	R, Rc
N	NPT

Metric sizes		
Applicable tubing O.D.	Connection thread Rc, NPT	Model
Ø 4	1/8"	LQ1L11-F□
Ø 3		LQ1L12-F□
Ø 6		LQ1L21-F□
Ø 4	1/8"	LQ1L22-F□
Ø 3		LQ1L2C-F□
Ø 6		LQ1L23-F□
Ø 4	1/4"	LQ1L24-F□
Ø 3		LQ1L2F-F□
Ø 10		LQ1L31-F□
Ø 8	1/4"	LQ1L32-F□
Ø 6		LQ1L33-F□
Ø 10		LQ1L34-F□
Ø 8	3/8"	LQ1L35-F□
Ø 6		LQ1L36-F□
Ø 3		LQ1L3E-F□
Ø 10	1/8"	LQ1L39-F□
Ø 8		LQ1L310-F□
Ø 12		3/8"
Ø 10	1/2"	LQ1L42-F□
Ø 12		LQ1L43-F□
Ø 10		LQ1L44-F□
Ø 12	1/4"	LQ1L49-F□
Ø 12		LQ1L40-F□
Ø 19		LQ1L51-F□
Ø 12	1/2"	LQ1L52-F□
Ø 19		LQ1L53-F□
Ø 12		LQ1L54-F□
Ø 19	3/4"	LQ1L59-F□
Ø 19		LQ1L61-F□
Ø 25		LQ1L62-F□
Ø 19	1"	LQ1L63-F□
Ø 25		LQ1L64-F□
Ø 19		LQ1L64-F□
Inch sizes		
Applicable tubing O.D.	Connection thread Rc, NPT	Model
1/8"	1/8"	LQ1L1A-F□
1/4"		LQ1L2A-F□
3/16"		LQ1L2B-F□
1/8"	1/8"	LQ1L2C-F□
1/4"		LQ1L2D-F□
3/16"		LQ1L2E-F□
1/8"	1/4"	LQ1L2F-F□
3/8"		LQ1L3A-F□
1/4"		LQ1L3B-F□
3/8"	1/4"	LQ1L3C-F□
1/4"		LQ1L3D-F□
1/8"		LQ1L3E-F□
3/8"	1/8"	LQ1L3F-F□
1/2"		LQ1L4A-F□
3/8"		LQ1L4B-F□
1/2"	3/8"	LQ1L4C-F□
3/8"		LQ1L4D-F□
1/2"		LQ1L4E-F□
3/4"	1/2"	LQ1L4F-F□
1/2"		LQ1L4H-F□
3/4"		LQ1L5A-F□
1/2"	1/2"	LQ1L5B-F□
3/4"		LQ1L5C-F□
1/2"		LQ1L5D-F□
3/4"	3/4"	LQ1L5E-F□
1"		LQ1L5H-F□
3/4"		LQ1L6A-F□
1"	1"	LQ1L6B-F□
3/4"		LQ1L6C-F□
3/4"		LQ1L6D-F□

Note) For dimensions and other details refer to specific catalogue of the series at www.smc.eu

- KQ2
- KQ2-Uni
- KQB2
- KS/KX
- KM
- KF
- M
- H/DL L/LL
- KC
- KK
- KKH
- KK 130
- DM
- DMK
- KDM
- MQR
- KB
- KR-W2
- KRM
- KA
- KQG2
- KG
- KFG2
- MS
- KKA
- KP
- KPQ/KPG
- LQ1
- LQ3
- LQHB

Male run tee

LQ1R-M

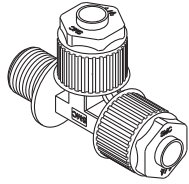

Enter the thread type in □.

—	R, Rc
N	NPT

Metric sizes		
Applicable tubing O.D.	Connection thread R, NPT	Model
Ø 4	1/8"	LQ1R11-M□
Ø 3		LQ1R12-M□
Ø 6	1/8"	LQ1R21-M□
Ø 4		LQ1R22-M□
Ø 3		LQ1R2C-M□
Ø 6		LQ1R23-M□
Ø 4	1/4"	LQ1R24-M□
Ø 3		LQ1R2F-M□
Ø 10		LQ1R31-M□
Ø 8	1/4"	LQ1R32-M□
Ø 6		LQ1R33-M□
Ø 10		LQ1R34-M□
Ø 8	3/8"	LQ1R35-M□
Ø 6		LQ1R36-M□
Ø 10	1/8"	*LQ1R39-M□
Ø 8		*LQ1R310-M□
Ø 12	3/8"	LQ1R41-M□
Ø 10		LQ1R42-M□
Ø 12	1/2"	LQ1R43-M□
Ø 10		LQ1R44-M□
Ø 12	1/4"	LQ1R49-M□
Ø 19	1/2"	LQ1R51-M□
Ø 12		LQ1R52-M□
Ø 19	3/4"	LQ1R53-M□
Ø 12		LQ1R54-M□
Ø 19	1/4"	LQ1R58-M□
Ø 19	3/8"	LQ1R59-M□
Ø 25	3/4"	LQ1R61-M□
Ø 19		LQ1R62-M□
Ø 25	1"	LQ1R63-M□
Ø 19		LQ1R64-M□

Inch sizes		
Applicable tubing O.D.	Connection thread R, NPT	Model
1/8"	1/8"	LQ1R1A-M□
1/4"	1/8"	LQ1R2A-M□
3/16"		LQ1R2B-M□
1/8"	1/4"	LQ1R2C-M□
1/4"		LQ1R2D-M□
3/16"		LQ1R2E-M□
1/8"	1/4"	LQ1R2F-M□
3/8"		LQ1R3A-M□
1/4"	1/4"	LQ1R3B-M□
3/8"		LQ1R3C-M□
1/4"	3/8"	LQ1R3D-M□
3/8"		LQ1R3F-M□
1/2"	3/8"	LQ1R4A-M□
3/8"		LQ1R4B-M□
1/2"	1/2"	LQ1R4C-M□
3/8"		LQ1R4D-M□
1/2"	1/4"	LQ1R4G-M□
3/4"	1/2"	LQ1R5A-M□
1/2"		LQ1R5B-M□
3/4"	3/4"	LQ1R5C-M□
1/2"		LQ1R5D-M□
3/4"	1/4"	LQ1R5G-M□
3/4"	3/8"	LQ1R5H-M□
1"	3/4"	LQ1R6A-M□
3/4"		LQ1R6B-M□
1"	1"	LQ1R6C-M□
3/4"		LQ1R6D-M□

Note) Products marked "*" are produced upon receipt of order. (The body of the fitting is PTFE machined.)

Female run tee

LQ1R-F

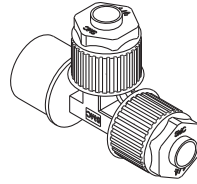

Enter the thread type in □.

—	R, Rc
N	NPT

Metric sizes		
Applicable tubing O.D.	Connection thread Rc, NPT	Model
Ø 4	1/8"	LQ1R11-F□
Ø 3		LQ1R12-F□
Ø 6	1/8"	LQ1R21-F□
Ø 4		LQ1R22-F□
Ø 3		LQ1R2C-F□
Ø 6		LQ1R23-F□
Ø 4	1/4"	LQ1R24-F□
Ø 3		LQ1R2F-F□
Ø 10		LQ1R31-F□
Ø 8	1/4"	LQ1R32-F□
Ø 6		LQ1R33-F□
Ø 10		LQ1R34-F□
Ø 8	3/8"	LQ1R35-F□
Ø 6		LQ1R36-F□
Ø 10	1/8"	*LQ1R39-F□
Ø 8		*LQ1R310-F□
Ø 12	3/8"	LQ1R41-F□
Ø 10		LQ1R42-F□
Ø 12	1/2"	LQ1R43-F□
Ø 10		LQ1R44-F□
Ø 12	1/4"	*LQ1R49-F□
Ø 19	1/2"	LQ1R51-F□
Ø 12		LQ1R52-F□
Ø 19	3/4"	LQ1R53-F□
Ø 12		LQ1R54-F□
Ø 19	3/8"	LQ1R59-F□
Ø 25	3/4"	LQ1R61-F□
Ø 19		LQ1R62-F□
Ø 25	1"	LQ1R63-F□
Ø 19		LQ1R64-F□
Ø 25	1/2"	LQ1R66-F□

Inch sizes		
Applicable tubing O.D.	Connection thread Rc, NPT	Model
1/8"	1/8"	LQ1R1A-F□
1/4"	1/8"	LQ1R2A-F□
3/16"		LQ1R2B-F□
1/8"	1/4"	LQ1R2C-F□
1/4"		LQ1R2D-F□
3/16"		LQ1R2E-F□
1/8"	1/4"	LQ1R2F-F□
3/8"		LQ1R3A-F□
1/4"	1/4"	LQ1R3B-F□
3/8"		LQ1R3C-F□
1/4"	3/8"	LQ1R3D-F□
3/8"		LQ1R3F-F□
1/2"	3/8"	LQ1R4A-F□
3/8"		LQ1R4B-F□
1/2"	1/2"	LQ1R4C-F□
3/8"		LQ1R4D-F□
1/2"	1/4"	*LQ1R4G-F□
3/4"	1/2"	LQ1R5A-F□
1/2"		LQ1R5B-F□
3/4"	3/4"	LQ1R5C-F□
1/2"		LQ1R5D-F□
3/4"	3/8"	LQ1R5H-F□
1"	3/4"	LQ1R6A-F□
3/4"		LQ1R6B-F□
1"	1"	LQ1R6C-F□
3/4"		LQ1R6D-F□

Note) Products marked "*" are produced upon receipt of order. (The body of the fitting is PTFE machined.)

Note) For dimensions and other details refer to specific catalogue of the series at www.smc.eu

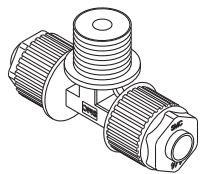
Male branch tee
LQ1B-M

Enter the thread type in □.

—	R, Rc
N	NPT

Metric sizes		
Applicable tubing O.D.	Connection thread R, NPT	Model
Ø 4	1/8"	LQ1B11-M□
Ø 3		LQ1B12-M□
Ø 6	1/8"	LQ1B21-M□
Ø 4		LQ1B22-M□
Ø 3		LQ1B2C-M□
Ø 6	1/4"	LQ1B23-M□
Ø 4		LQ1B24-M□
Ø 3		LQ1B2F-M□
Ø 10	1/4"	LQ1B31-M□
Ø 8		LQ1B32-M□
Ø 6		LQ1B33-M□
Ø 10	3/8"	LQ1B34-M□
Ø 8		LQ1B35-M□
Ø 6	1/8"	LQ1B36-M□
Ø 10		*LQ1B39-M□
Ø 8	3/8"	*LQ1B310-M□
Ø 12		LQ1B41-M□
Ø 10	1/2"	LQ1B42-M□
Ø 12		LQ1B43-M□
Ø 10	1/4"	LQ1B44-M□
Ø 8		*LQ1B45-M□
Ø 12	1/2"	LQ1B49-M□
Ø 19		LQ1B51-M□
Ø 12	3/4"	LQ1B52-M□
Ø 19		LQ1B53-M□
Ø 12	1/4"	LQ1B54-M□
Ø 19		LQ1B58-M□
Ø 19	3/8"	LQ1B59-M□
Ø 25		LQ1B61-M□
Ø 19	1"	LQ1B62-M□
Ø 25		LQ1B63-M□
Ø 19	1/2"	LQ1B64-M□
Ø 25		LQ1B66-M□
Inch sizes		
Applicable tubing O.D.	Connection thread R, NPT	Model
1/8"	1/8"	LQ1B1A-M□
1/4"		LQ1B2A-M□
3/16"	1/8"	LQ1B2B-M□
1/8"		LQ1B2C-M□
1/4"	1/4"	LQ1B2D-M□
3/16"		LQ1B2E-M□
1/8"	1/4"	LQ1B2F-M□
3/8"		LQ1B3A-M□
1/4"	3/8"	LQ1B3B-M□
3/8"		LQ1B3C-M□
1/4"	1/8"	LQ1B3D-M□
3/8"		*LQ1B3F-M□
1/2"	3/8"	LQ1B4A-M□
3/8"		LQ1B4B-M□
1/2"	1/2"	LQ1B4C-M□
3/8"		LQ1B4D-M□
1/2"	1/4"	LQ1B4G-M□
3/4"		LQ1B5A-M□
1/2"	3/4"	LQ1B5B-M□
3/4"		LQ1B5C-M□
1/2"	1/4"	LQ1B5D-M□
3/4"		LQ1B5G-M□
3/4"	3/8"	LQ1B5H-M□
1"		LQ1B6A-M□
3/4"	1"	LQ1B6B-M□
1"		LQ1B6C-M□
3/4"	1/2"	LQ1B6D-M□
1"		LQ1B6F-M□

Note) Products marked "*" are produced upon receipt of order. (The body of the fitting is PTFE machined.)

Note) For dimensions and other details refer to specific catalogue of the series at www.smc.eu

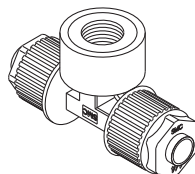
Female branch tee
LQ1B-F

Enter the thread type in □.

—	R, Rc
N	NPT

Metric sizes		
Applicable tubing O.D.	Connection thread Rc, NPT	Model
Ø 4	1/8"	LQ1B11-F□
Ø 3		LQ1B12-F□
Ø 6	1/8"	LQ1B21-F□
Ø 4		LQ1B22-F□
Ø 3		LQ1B2C-F□
Ø 6	1/4"	LQ1B23-F□
Ø 4		LQ1B24-F□
Ø 3		LQ1B2F-F□
Ø 10	1/4"	LQ1B31-F□
Ø 8		LQ1B32-F□
Ø 6		LQ1B33-F□
Ø 10	3/8"	LQ1B34-F□
Ø 8		LQ1B35-F□
Ø 6	1/8"	LQ1B36-F□
Ø 10		*LQ1B39-F□
Ø 8	3/8"	*LQ1B310-F□
Ø 12		LQ1B41-F□
Ø 10	1/2"	LQ1B42-F□
Ø 12		LQ1B43-F□
Ø 10	1/4"	LQ1B44-F□
Ø 12		*LQ1B49-F□
Ø 19	1/2"	LQ1B51-F□
Ø 12		LQ1B52-F□
Ø 19	3/4"	LQ1B53-F□
Ø 12		LQ1B54-F□
Ø 19	1/4"	*LQ1B58-F□
Ø 19		*LQ1B59-F□
Ø 25	3/4"	LQ1B61-F□
Ø 19		LQ1B62-F□
Ø 25	1"	LQ1B63-F□
Ø 19		LQ1B64-F□
Ø 25	1/2"	LQ1B66-F□
Inch sizes		
Applicable tubing O.D.	Connection thread Rc, NPT	Model
1/8"	1/8"	LQ1B1A-F□
1/4"		LQ1B2A-F□
3/16"	1/8"	LQ1B2B-F□
1/8"		LQ1B2C-F□
1/4"	1/4"	LQ1B2D-F□
3/16"		LQ1B2E-F□
1/8"	1/4"	LQ1B2F-F□
3/8"		LQ1B3A-F□
1/4"	3/8"	LQ1B3B-F□
3/8"		LQ1B3C-F□
1/4"	1/8"	LQ1B3D-F□
3/8"		*LQ1B3F-F□
1/2"	3/8"	LQ1B4A-F□
3/8"		LQ1B4B-F□
1/2"	1/2"	LQ1B4C-F□
3/8"		LQ1B4D-F□
1/2"	1/4"	*LQ1B4G-F□
3/4"		LQ1B5A-F□
1/2"	3/4"	LQ1B5B-F□
3/4"		LQ1B5C-F□
1/2"	1/4"	LQ1B5D-F□
3/4"		LQ1B5G-F□
3/4"	3/8"	LQ1B5H-F□
1"		LQ1B6A-F□
3/4"	1"	LQ1B6B-F□
1"		LQ1B6C-F□
3/4"	1/2"	LQ1B6D-F□
1"		LQ1B6F-F□

Note) Products marked "*" are produced upon receipt of order. (The body of the fitting is PTFE machined.)

KQ2

KQ2-Uni

KQB2

KS/KX

KM

KF

M

 H/DL
L/LL

KC

KK

KKH

 KK
130

DM

DMK

KDM

MQR

KB

 KR
-W2

KRM

KA

KQG2

KG

KFG2

MS

KKA

KP

 KPQ/
KPG

LQ1

LQ3

LQHB

Union elbow

LQ1E

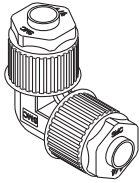

Metric sizes	
Applicable tubing O.D.	Model
Ø 4	LQ1E11
Ø 3	LQ1E12
Ø 6	LQ1E21□□
Ø 4	LQ1E22□□
Ø 3	LQ1E2C□□
Ø 10	LQ1E31□□
Ø 8	LQ1E32□□
Ø 6	LQ1E33□□
Ø 12	LQ1E41□□
Ø 10	LQ1E42□□
Ø 19	LQ1E51□□
Ø 12	LQ1E52□□
Ø 25	LQ1E61□□
Ø 19	LQ1E62□□
Inch sizes	
Applicable tubing O.D.	Model
1/8"	LQ1E1A
1/4"	LQ1E2A□□
3/16"	LQ1E2B□□
1/8"	LQ1E2C□□
3/8"	LQ1E3A□□
1/4"	LQ1E3B□□
1/2"	LQ1E4A□□
3/8"	LQ1E4B□□
3/4"	LQ1E5A□□
1/2"	LQ1E5B□□
1"	LQ1E6A□□
3/4"	LQ1E6B□□

Enter the symbol for combination of different diameter sizes in □□.
Refer to page 171 for details.

Union tee

LQ1T

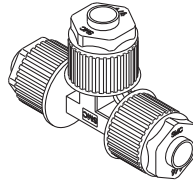

Metric sizes	
Applicable tubing O.D.	Model
Ø 4	LQ1T11
Ø 3	LQ1T12
Ø 6	LQ1T21□□
Ø 4	LQ1T22□□
Ø 3	LQ1T2C□□
Ø 10	LQ1T31□□
Ø 8	LQ1T32□□
Ø 6	LQ1T33□□
Ø 12	LQ1T41□□
Ø 10	LQ1T42□□
Ø 19	LQ1T51□□
Ø 12	LQ1T52□□
Ø 25	LQ1T61□□
Ø 19	LQ1T62□□
Inch sizes	
Applicable tubing O.D.	Model
1/8"	LQ1T1A
1/4"	LQ1T2A□□
3/16"	LQ1T2B□□
1/8"	LQ1T2C□□
3/8"	LQ1T3A□□
1/4"	LQ1T3B□□
1/2"	LQ1T4A□□
3/8"	LQ1T4B□□
3/4"	LQ1T5A□□
1/2"	LQ1T5B□□
1"	LQ1T6A□□
3/4"	LQ1T6B□□

Enter the symbol for combination of different diameter sizes in □□.
Refer to page 171 for details.

Note) For dimensions and other details refer to specific catalogue of the series at www.smc.eu

Panel mount union

LQ1P

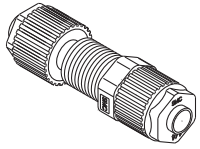

Metric sizes	
Applicable tubing O.D.	Model
Ø 4	LQ1P11
Ø 3	LQ1P12
Ø 6	LQ1P21□□
Ø 4	LQ1P22□□
Ø 3	LQ1P2C□□
Ø 10	LQ1P31□□
Ø 8	LQ1P32□□
Ø 6	LQ1P33□□
Ø 12	LQ1P41□□
Ø 10	LQ1P42□□
Ø 19	LQ1P51□□
Ø 12	LQ1P52□□
Ø 25	LQ1P61□□
Ø 19	LQ1P62□□
Inch sizes	
Applicable tubing O.D.	Model
1/8"	LQ1P1A
1/4"	LQ1P2A□□
3/16"	LQ1P2B□□
1/8"	LQ1P2C□□
3/8"	LQ1P3A□□
1/4"	LQ1P3B□□
1/2"	LQ1P4A□□
3/8"	LQ1P4B□□
3/4"	LQ1P5A□□
1/2"	LQ1P5B□□
1"	LQ1P6A□□
3/4"	LQ1P6B□□

Enter the symbol for combination of different diameter sizes in □□.
Refer to page 171 for details.

Union

LQ1U

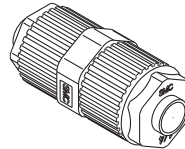

Metric sizes	
Applicable tubing O.D.	Model
Ø 4	LQ1U11
Ø 3	LQ1U12
Ø 6	LQ1U21□□
Ø 4	LQ1U22□□
Ø 3	LQ1U2C□□
Ø 10	LQ1U31□□
Ø 8	LQ1U32□□
Ø 6	LQ1U33□□
Ø 12	LQ1U41□□
Ø 10	LQ1U42□□
Ø 19	LQ1U51□□
Ø 12	LQ1U52□□
Ø 25	LQ1U61□□
Ø 19	LQ1U62□□
Inch sizes	
Applicable tubing O.D.	Model
1/8"	LQ1U1A
1/4"	LQ1U2A□□
3/16"	LQ1U2B□□
1/8"	LQ1U2C□□
3/8"	LQ1U3A□□
1/4"	LQ1U3B□□
1/2"	LQ1U4A□□
3/8"	LQ1U4B□□
3/4"	LQ1U5A□□
1/2"	LQ1U5B□□
1"	LQ1U6A□□
3/4"	LQ1U6B□□

Enter the symbol for combination of different diameter sizes in □□.
Refer to page 171 for details.

Union flange

LQ1F

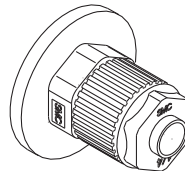

Metric sizes	
Applicable tubing O.D.	Model
Ø 12	LQ1F41
Ø 10	LQ1F42
Ø 19	LQ1F51
Ø 12	LQ1F52
Ø 25	LQ1F61
Ø 19	LQ1F62
Inch sizes	
Applicable tubing O.D.	Model
1/2"	LQ1F4A
3/8"	LQ1F4B
3/4"	LQ1F5A
1/2"	LQ1F5B
1"	LQ1F6A
3/4"	LQ1F6B

Note) For dimensions and other details refer to specific catalogue of the series at www.smc.eu

Fluoropolymer Fittings/Flare Type



LQ3 Series

■ Applicable tubing O.D. : Metric Size/Inch Sizes

■ Connection thread : R, Rc, NPT

Heat Resistant

Corrosion Resistant

Clean

- 200 °C compatible
- Excellent heat resistance
- Excellent flow-through characteristics
- Ease of installation
- Triple-seal construction
- Flare type collet construction

Specifications

Feature	Model	LQ3□10	LQ3□20	LQ3□30	LQ3□40	LQ3□50	LQ3□60	LQ3□70
Material		NEW PFA						
Maximum operating pressure (at 20 °C)		1 MPa						
Proof pressure		Refer to the withstand pressure and heat resistance performance data.						
Operating temperature	Nut material PVDF	0 to 150 °C						
	Nut material PFA	0 to 200 °C						

Withstand Pressure and Heat Resistance Performance

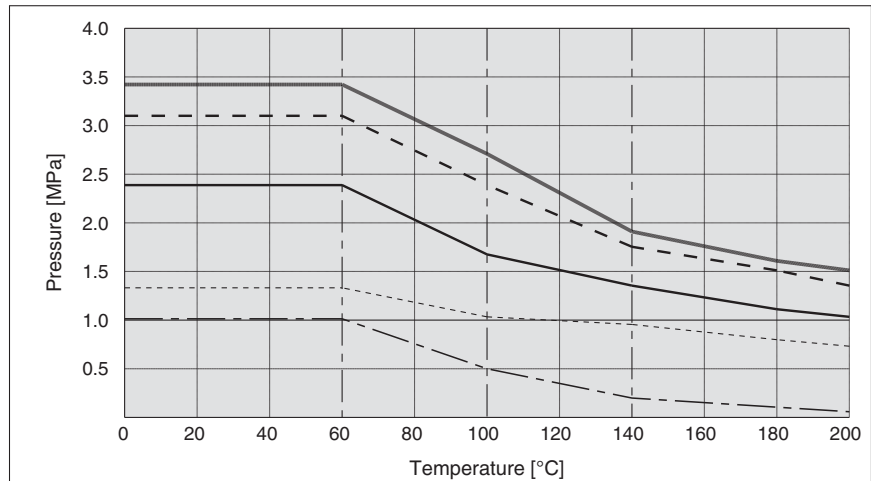

For details about precautions and specifications, refer to the **WEB catalogue** at www.smc.eu

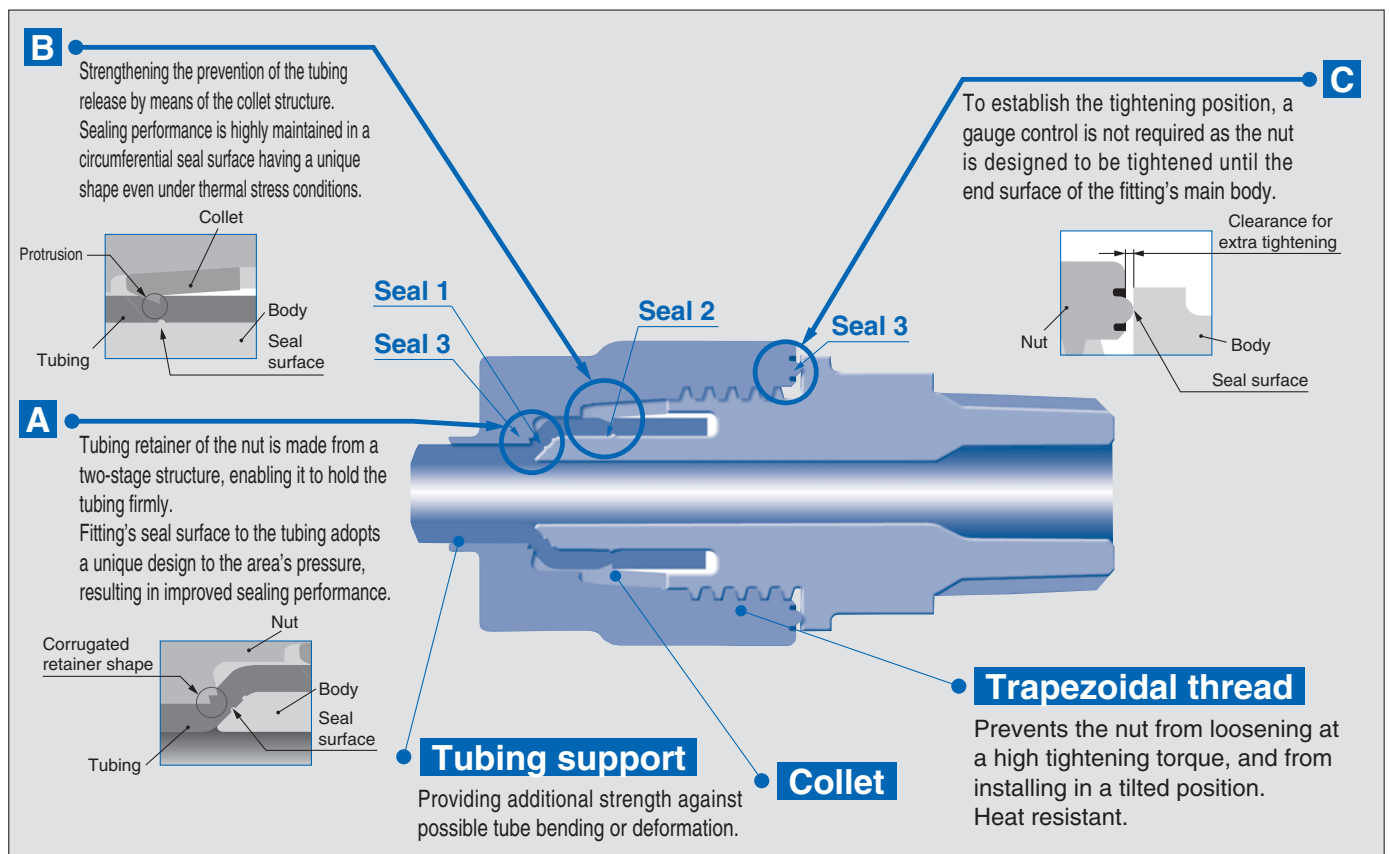

Threaded connection

Connector

LQ3H

Male

Female

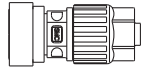
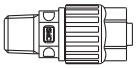

P.175

Elbow

LQ3L

Male

Female

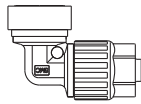
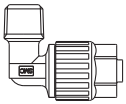

P.176

Branch

LQ3B

Male

Female

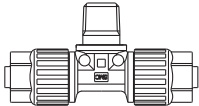

P.177

Run tee

LQ3R

Male

Female

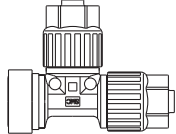
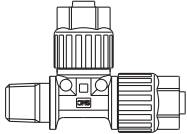

P.178

Tubing connection

Union elbow

LQ3E

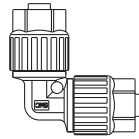

P.179

Union tee

LQ3T

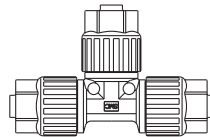

P.179

Panel mount union

LQ3P

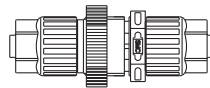

P.179

Union

LQ3U

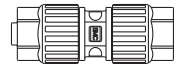

P.179

Space saving union elbow

LQ3E-S

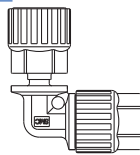

p. 174

Space saving branch tee

LQ3T-SB

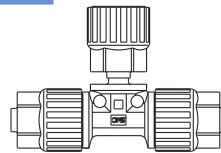

p. 174

Space saving run tee

LQ3T-SR



p. 174

Union reducing

LQ3U-R

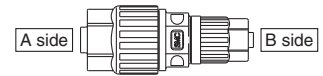

P.180

Union elbow reducing

LQ3E-R

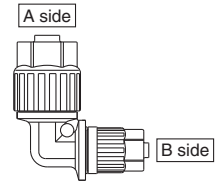

P.180

Union tee reducing

LQ3T-R

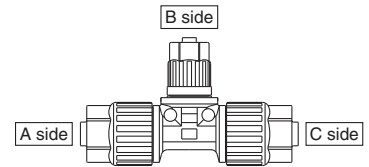

P.181

Tubing extension straight connector

LQ3H-T

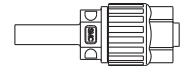

P.181

Straight adapter

LQ3A

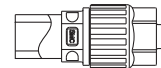

P.182

Union flange

LQ3F

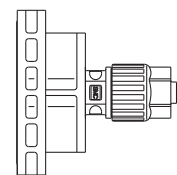

P.182

Space saving union elbow

LQ3E-S

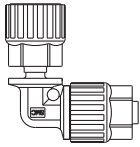

Metric size	
Applicable tubing O.D.	Model
ø6	LQ3E21-S
ø10	LQ3E31-S
ø8	LQ3E32-S
ø12	LQ3E41-S
ø19	LQ3E51-S
ø25	LQ3E61-S
Inch size	
Applicable tubing O.D.	Model
1/4"	LQ3E2A-S
3/8"	LQ3E3A-S
1/2"	LQ3E4A-S
3/4"	LQ3E5A-S
1"	LQ3E6A-S
1 1/4"	LQ3E7A-S

Space saving run tee

LQ3T-SR

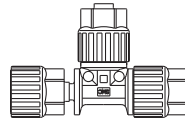

Metric size	
Applicable tubing O.D.	Model
ø6	LQ3T21-SR
ø10	LQ3T31-SR
ø8	LQ3T32-SR
ø12	LQ3T41-SR
ø19	LQ3T51-SR
ø25	LQ3T61-SR
Inch size	
Applicable tubing O.D.	Model
1/4"	LQ3T2A-SR
3/8"	LQ3T3A-SR
1/2"	LQ3T4A-SR
3/4"	LQ3T5A-SR
1"	LQ3T6A-SR

Space saving branch tee

LQ3T-SB

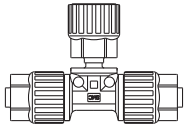

Metric size	
Applicable tubing O.D.	Model
ø6	LQ3T21-SB
ø10	LQ3T31-SB
ø8	LQ3T32-SB
ø12	LQ3T41-SB
ø19	LQ3T51-SB
ø25	LQ3T61-SB
Inch size	
Applicable tubing O.D.	Model
1/4"	LQ3T2A-SB
3/8"	LQ3T3A-SB
1/2"	LQ3T4A-SB
3/4"	LQ3T5A-SB
1"	LQ3T6A-SB

Note) For dimensions and other details refer to specific catalogue of the series at www.smc.eu

KQ2
KQ2-
Uni
KQ32
KS/
KX
KM
KF
M
H/D
L/L
KO
KK
KKH
KK
130
DM
DMK
KDM
MCR
KB
KF
-W2
KRM
KA
KQ2
KG
KQ2
MS
KKA
KF
KPO/
KPS
LQ1
LQ3
LQHB

Male connector

LQ3H-M

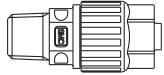

Metric sizes		
Applicable tubing O.D.	Connection thread R, NPT	Model
Ø 4	1/8"	LQ3H11-M□
Ø 3		LQ3H12-M□
Ø 6	1/8"	LQ3H21-M□
	1/4"	LQ3H22-M□
Ø 10	1/8"	LQ3H31-M□
		LQ3H32-M□
Ø 10	1/4"	LQ3H33-M□
		LQ3H34-M□
Ø 8	3/8"	LQ3H35-M□
		LQ3H36-M□
Ø 12	1/2"	LQ3H38-M□
	1/4"	LQ3H41-M□
	3/8"	LQ3H42-M□
	1/2"	LQ3H43-M□
Ø 19	3/4"	LQ3H44-M□
	3/8"	LQ3H51-M□
Ø 19	1/2"	LQ3H52-M□
	3/4"	LQ3H53-M□
Ø 25	1/2"	LQ3H61-M□
	3/4"	LQ3H62-M□
	1"	LQ3H63-M□
Inch sizes		
Applicable tubing O.D.	Connection thread R, NPT	Model
1/8"	1/8"	LQ3H1A-M□
1/4"	1/8"	LQ3H2A-M□
	1/4"	LQ3H2B-M□
3/8"	1/8"	LQ3H3A-M□
	1/4"	LQ3H3B-M□
	3/8"	LQ3H3C-M□
	1/2"	LQ3H3D-M□
1/2"	1/4"	LQ3H4A-M□
	3/8"	LQ3H4B-M□
	1/2"	LQ3H4C-M□
3/4"	3/4"	LQ3H4D-M□
	3/8"	LQ3H5A-M□
	1/2"	LQ3H5B-M□
1"	3/4"	LQ3H5C-M□
	1/2"	LQ3H6A-M□
	3/4"	LQ3H6B-M□
1 1/4"	1"	LQ3H6C-M□
	3/4"	LQ3H7A-M□
	1"	LQ3H7B-M□
1 1/2"	1 1/4"	LQ3H7C-M□
	1"	LQ3H8A-M□
	1 1/4"	LQ3H8B-M□
	1 1/2"	LQ3H8C-M□

Enter the thread type in □.

—	R, Rc
N	NPT

Female connector

LQ3H-F

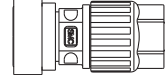

Metric sizes		
Applicable tubing O.D.	Connection thread Rc, NPT	Model
Ø 4	1/8"	LQ3H11-F□
Ø 3		LQ3H12-F□
Ø 6	1/8"	LQ3H21-F□
	1/4"	LQ3H22-F□
Ø 10	1/8"	LQ3H31-F□
		LQ3H32-F□
Ø 10	1/4"	LQ3H33-F□
		LQ3H34-F□
Ø 8	3/8"	LQ3H35-F□
		LQ3H36-F□
Ø 12	1/4"	LQ3H41-F□
	3/8"	LQ3H42-F□
	1/2"	LQ3H43-F□
Ø 19	3/8"	LQ3H51-F□
	1/2"	LQ3H52-F□
Ø 19	3/4"	LQ3H53-F□
	1/2"	LQ3H61-F□
Ø 25	3/4"	LQ3H62-F□
	1"	LQ3H63-F□
Inch sizes		
Applicable tubing O.D.	Connection thread Rc, NPT	Model
1/8"	1/8"	LQ3H1A-F□
1/4"	1/8"	LQ3H2A-F□
	1/4"	LQ3H2B-F□
3/8"	1/8"	LQ3H3A-F□
	1/4"	LQ3H3B-F□
3/8"	3/8"	LQ3H3C-F□
	1/2"	LQ3H4A-F□
1/2"	3/8"	LQ3H4B-F□
	1/2"	LQ3H4C-F□
3/4"	3/8"	LQ3H5A-F□
	1/2"	LQ3H5B-F□
3/4"	3/4"	LQ3H5C-F□
	1"	LQ3H6A-F□
1"	3/4"	LQ3H6B-F□
	1"	LQ3H6C-F□

Enter the thread type in □.

—	R, Rc
N	NPT

Note) For dimensions and other details refer to specific catalogue of the series at www.smc.eu

Male elbow

LQ3L-M

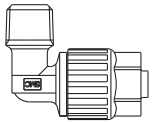

Metric sizes		
Applicable tubing O.D.	Connection thread R, NPT	Model
Ø 4	1/8"	LQ3L11-M□
Ø 3		LQ3L12-M□
Ø 6	1/8"	LQ3L21-M□
	1/4"	LQ3L22-M□
Ø 10	1/8"	LQ3L31-M□
Ø 8		LQ3L32-M□
Ø 10	1/4"	LQ3L33-M□
Ø 8		LQ3L34-M□
Ø 10	3/8"	LQ3L35-M□
	Ø 8	3/8"
Ø 12		1/2"
	1/4"	LQ3L41-M□
	3/8"	LQ3L42-M□
Ø 19	1/2"	LQ3L51-M□
	3/8"	LQ3L52-M□
	3/4"	LQ3L53-M□
Ø 25	1/2"	LQ3L61-M□
	3/4"	LQ3L62-M□
	1"	LQ3L63-M□
Inch sizes		
Applicable tubing O.D.	Connection thread R, NPT	Model
1/8"	1/8"	LQ3L1A-M□
1/4"	1/8"	LQ3L2A-M□
	1/4"	LQ3L2B-M□
3/8"	1/8"	LQ3L3A-M□
	1/4"	LQ3L3B-M□
	3/8"	LQ3L3C-M□
	1/2"	LQ3L3D-M□
1/2"	1/4"	LQ3L4A-M□
	3/8"	LQ3L4B-M□
	1/2"	LQ3L4C-M□
3/4"	3/8"	LQ3L5A-M□
	1/2"	LQ3L5B-M□
	3/4"	LQ3L5C-M□
1"	1/2"	LQ3L6A-M□
	3/4"	LQ3L6B-M□
	1"	LQ3L6C-M□

Enter the thread type in □.

—	R, Rc
N	NPT

Female elbow

LQ3L-F

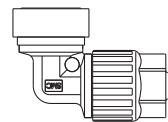

Metric sizes		
Applicable tubing O.D.	Connection thread Rc, NPT	Model
Ø 4	1/8"	LQ3L11-F□
Ø 3		LQ3L12-F□
Ø 6	1/8"	LQ3L21-F□
	1/4"	LQ3L22-F□
Ø 10	1/8"	LQ3L31-F□
Ø 8		LQ3L32-F□
Ø 10	1/4"	LQ3L33-F□
Ø 8		LQ3L34-F□
Ø 10	3/8"	LQ3L35-F□
	Ø 8	3/8"
Ø 12		1/4"
	3/8"	LQ3L42-F□
	1/2"	LQ3L43-F□
Ø 19	3/8"	LQ3L51-F□
	1/2"	LQ3L52-F□
	3/4"	LQ3L53-F□
Ø 25	1/2"	LQ3L61-F□
	3/4"	LQ3L62-F□
	1"	LQ3L63-F□
Inch sizes		
Applicable tubing O.D.	Connection thread Rc, NPT	Model
1/8"	1/8"	LQ3L1A-F□
1/4"	1/8"	LQ3L2A-F□
	1/4"	LQ3L2B-F□
3/8"	1/8"	LQ3L3A-F□
	1/4"	LQ3L3B-F□
	3/8"	LQ3L3C-F□
1/2"	1/4"	LQ3L4A-F□
	3/8"	LQ3L4B-F□
3/4"	1/2"	LQ3L4C-F□
	3/8"	LQ3L5A-F□
	1/2"	LQ3L5B-F□
1"	3/4"	LQ3L5C-F□
	1/2"	LQ3L6A-F□
	3/4"	LQ3L6B-F□
	1"	LQ3L6C-F□

Enter the thread type in □.

—	R, Rc
N	NPT

Note) For dimensions and other details refer to specific catalogue of the series at www.smc.eu

Male branch tee

LQ3B-M

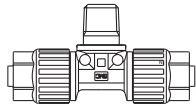

Metric sizes		
Applicable tubing O.D.	Connection thread R, NPT	Model
Ø 4	1/8"	LQ3B11-M□
		LQ3B12-M□
Ø 6	1/8"	LQ3B21-M□
	1/4"	LQ3B22-M□
Ø 10	1/8"	LQ3B31-M□
		LQ3B32-M□
Ø 10	1/4"	LQ3B33-M□
		LQ3B34-M□
Ø 8	3/8"	LQ3B35-M□
		LQ3B36-M□
Ø 12	1/4"	LQ3B41-M□
	3/8"	LQ3B42-M□
	1/2"	LQ3B43-M□
Ø 19	3/8"	LQ3B51-M□
	1/2"	LQ3B52-M□
	3/4"	LQ3B53-M□
Ø 25	1/2"	LQ3B61-M□
	3/4"	LQ3B62-M□
	1"	LQ3B63-M□
Inch sizes		
Applicable tubing O.D.	Connection thread R, NPT	Model
1/8"	1/8"	LQ3B1A-M□
1/4"	1/8"	LQ3B2A-M□
	1/4"	LQ3B2B-M□
3/8"	1/8"	LQ3B3A-M□
	1/4"	LQ3B3B-M□
	3/8"	LQ3B3C-M□
1/2"	1/4"	LQ3B4A-M□
	3/8"	LQ3B4B-M□
	1/2"	LQ3B4C-M□
3/4"	3/8"	LQ3B5A-M□
	1/2"	LQ3B5B-M□
	3/4"	LQ3B5C-M□
1"	1/2"	LQ3B6A-M□
	3/4"	LQ3B6B-M□
	1"	LQ3B6C-M□

Enter the thread type in □.

—	R, Rc
N	NPT

Female branch tee

LQ3B-F

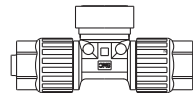

Metric sizes		
Applicable tubing O.D.	Connection thread Rc, NPT	Model
Ø 4	1/8"	LQ3B11-F□
		LQ3B12-F□
Ø 6	1/8"	LQ3B21-F□
	1/4"	LQ3B22-F□
Ø 10	1/8"	LQ3B31-F□
		LQ3B32-F□
Ø 10	1/4"	LQ3B33-F□
		LQ3B34-F□
Ø 8	3/8"	LQ3B35-F□
		LQ3B36-F□
Ø 12	1/4"	LQ3B41-F□
	3/8"	LQ3B42-F□
	1/2"	LQ3B43-F□
Ø 19	3/8"	LQ3B51-F□
	1/2"	LQ3B52-F□
	3/4"	LQ3B53-F□
Ø 25	1/2"	LQ3B61-F□
	3/4"	LQ3B62-F□
	1"	LQ3B63-F□
Inch sizes		
Applicable tubing O.D.	Connection thread Rc, NPT	Model
1/8"	1/8"	LQ3B1A-F□
1/4"	1/8"	LQ3B2A-F□
	1/4"	LQ3B2B-F□
3/8"	1/8"	LQ3B3A-F□
	1/4"	LQ3B3B-F□
	3/8"	LQ3B3C-F□
1/2"	1/4"	LQ3B4A-F□
	3/8"	LQ3B4B-F□
	1/2"	LQ3B4C-F□
3/4"	3/8"	LQ3B5A-F□
	1/2"	LQ3B5B-F□
	3/4"	LQ3B5C-F□
1"	1/2"	LQ3B6A-F□
	3/4"	LQ3B6B-F□
	1"	LQ3B6C-F□

Enter the thread type in □.

—	R, Rc
N	NPT

Note) For dimensions and other details refer to specific catalogue of the series at www.smc.eu

Male run tee

LQ3R-M

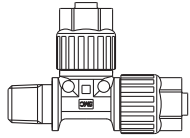

Metric sizes		
Applicable tubing O.D.	Connection thread R, NPT	Model
Ø 4	1/8"	LQ3R11-M□
		LQ3R12-M□
Ø 6	1/8"	LQ3R21-M□
	1/4"	LQ3R22-M□
Ø 10	1/8"	LQ3R31-M□
		LQ3R32-M□
Ø 10	1/4"	LQ3R33-M□
		LQ3R34-M□
Ø 8	3/8"	LQ3R35-M□
		LQ3R36-M□
Ø 12	1/4"	LQ3R41-M□
	3/8"	LQ3R42-M□
	1/2"	LQ3R43-M□
Ø 19	3/8"	LQ3R51-M□
	1/2"	LQ3R52-M□
	3/4"	LQ3R53-M□
Ø 25	1/2"	LQ3R61-M□
	3/4"	LQ3R62-M□
	1"	LQ3R63-M□
Inch sizes		
Applicable tubing O.D.	Connection thread R, NPT	Model
1/8"	1/8"	LQ3R1A-M□
1/4"	1/8"	LQ3R2A-M□
	1/4"	LQ3R2B-M□
3/8"	1/8"	LQ3R3A-M□
	1/4"	LQ3R3B-M□
	3/8"	LQ3R3C-M□
1/2"	1/4"	LQ3R4A-M□
	3/8"	LQ3R4B-M□
	1/2"	LQ3R4C-M□
3/4"	3/8"	LQ3R5A-M□
	1/2"	LQ3R5B-M□
	3/4"	LQ3R5C-M□
1"	1/2"	LQ3R6A-M□
	3/4"	LQ3R6B-M□
	1"	LQ3R6C-M□

Enter the thread type in □.

—	R, Rc
N	NPT

Female run tee

LQ3R-F

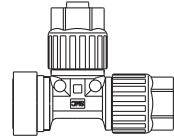

Metric sizes		
Applicable tubing O.D.	Connection thread Rc, NPT	Model
Ø 4	1/8"	LQ3R11-F□
		LQ3R12-F□
Ø 6	1/8"	LQ3R21-F□
	1/4"	LQ3R22-F□
Ø 10	1/8"	LQ3R31-F□
		LQ3R32-F□
Ø 10	1/4"	LQ3R33-F□
		LQ3R34-F□
Ø 8	3/8"	LQ3R35-F□
		LQ3R36-F□
Ø 12	1/4"	LQ3R41-F□
	3/8"	LQ3R42-F□
	1/2"	LQ3R43-F□
Ø 19	3/8"	LQ3R51-F□
	1/2"	LQ3R52-F□
	3/4"	LQ3R53-F□
Ø 25	1/2"	LQ3R61-F□
	3/4"	LQ3R62-F□
	1"	LQ3R63-F□
Inch sizes		
Applicable tubing O.D.	Connection thread Rc, NPT	Model
1/8"	1/8"	LQ3R1A-F□
1/4"	1/8"	LQ3R2A-F□
	1/4"	LQ3R2B-F□
3/8"	1/8"	LQ3R3A-F□
	1/4"	LQ3R3B-F□
	3/8"	LQ3R3C-F□
1/2"	1/4"	LQ3R4A-F□
	3/8"	LQ3R4B-F□
	1/2"	LQ3R4C-F□
3/4"	3/8"	LQ3R5A-F□
	1/2"	LQ3R5B-F□
	3/4"	LQ3R5C-F□
1"	1/2"	LQ3R6A-F□
	3/4"	LQ3R6B-F□
	1"	LQ3R6C-F□

Enter the thread type in □.

—	R, Rc
N	NPT

Note) For dimensions and other details refer to specific catalogue of the series at www.smc.eu

- KQ2
- KQ2-Uni
- KQB2
- KS/KX
- KM
- KF
- M
- H/DL L/LL
- KC
- KK
- KKH
- KK 130
- DM
- DMK
- KDM
- MQR
- KB
- KR-W2
- KRM
- KA
- KQG2
- KG
- KFG2
- MS
- KKA
- KP
- KPQ/KPG
- LQ1
- LQ3
- LQHB

Union elbow

LQ3E

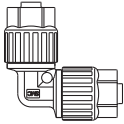

Metric sizes	
Applicable tubing O.D.	Model
Ø 4	LQ3E11
Ø 3	LQ3E12
Ø 6	LQ3E21
Ø 10	LQ3E31
Ø 8	LQ3E32
Ø 12	LQ3E41
Ø 19	LQ3E51
Ø 25	LQ3E61
Inch sizes	
Applicable tubing O.D.	Model
1/8"	LQ3E1A
1/4"	LQ3E2A
3/8"	LQ3E3A
1/2"	LQ3E4A
3/4"	LQ3E5A
1"	LQ3E6A
1 1/4"	LQ3E7A
1 1/2"	LQ3E8A

Panel mount union

LQ3P

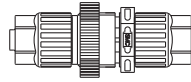

Metric sizes	
Applicable tubing O.D.	Model
Ø 4	LQ3P11
Ø 3	LQ3P12
Ø 6	LQ3P21
Ø 10	LQ3P31
Ø 8	LQ3P32
Ø 12	LQ3P41
Ø 19	LQ3P51
Ø 25	LQ3P61
Inch sizes	
Applicable tubing O.D.	Model
1/8"	LQ3P1A
1/4"	LQ3P2A
3/8"	LQ3P3A
1/2"	LQ3P4A
3/4"	LQ3P5A
1"	LQ3P6A

Union tee

LQ3T

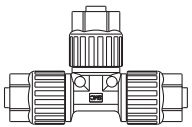

Metric sizes	
Applicable tubing O.D.	Model
Ø 4	LQ3T11
Ø 3	LQ3T12
Ø 6	LQ3T21
Ø 10	LQ3T31
Ø 8	LQ3T32
Ø 12	LQ3T41
Ø 19	LQ3T51
Ø 25	LQ3T61
Inch sizes	
Applicable tubing O.D.	Model
1/8"	LQ3T1A
1/4"	LQ3T2A
3/8"	LQ3T3A
1/2"	LQ3T4A
3/4"	LQ3T5A
1"	LQ3T6A
1 1/4"	LQ3T7A
1 1/2"	LQ3T8A

Union

LQ3U

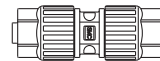

Metric sizes	
Applicable tubing O.D.	Model
Ø 4	LQ3U11
Ø 3	LQ3U12
Ø 6	LQ3U21
Ø 10	LQ3U31
Ø 8	LQ3U32
Ø 12	LQ3U41
Ø 19	LQ3U51
Ø 25	LQ3U61
Inch sizes	
Applicable tubing O.D.	Model
1/8"	LQ3U1A
1/4"	LQ3U2A
3/8"	LQ3U3A
1/2"	LQ3U4A
3/4"	LQ3U5A
1"	LQ3U6A
1 1/4"	LQ3U7A
1 1/2"	LQ3U8A

Note) For dimensions and other details refer to specific catalogue of the series at www.smc.eu

Union reducing

LQ3U-R

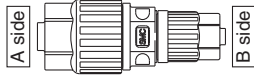

Metric sizes		
Applicable tubing O.D.		Model
A side	B side	
Ø 4	Ø 3	LQ3U11-R1
Ø 6	Ø 4	LQ3U21-R1
	Ø 3	LQ3U21-R2
Ø 10	Ø 8	LQ3U31-R1
	Ø 6	LQ3U31-R2
Ø 8	Ø 6	LQ3U32-R1
	Ø 4	LQ3U32-R2
Ø 12	Ø 10	LQ3U41-R1
	Ø 8	LQ3U41-R2
Ø 19	Ø 12	LQ3U51-R1
	Ø 10	LQ3U51-R2
Ø 25	Ø 19	LQ3U61-R1
	Ø 12	LQ3U61-R2
Inch sizes		
Applicable tubing O.D.		Model
A side	B side	
1/4"	1/8"	LQ3U2A-R1
3/8"	1/4"	LQ3U3A-R1
	1/8"	LQ3U3A-R2
1/2"	3/8"	LQ3U4A-R1
	1/4"	LQ3U4A-R2
3/4"	1/2"	LQ3U5A-R1
	3/8"	LQ3U5A-R2
	1/4"	LQ3U5A-R3
1"	3/4"	LQ3U6A-R1
	1/2"	LQ3U6A-R2
1 1/4"	1"	LQ3U7A-R1

Union elbow reducing

LQ3E-R

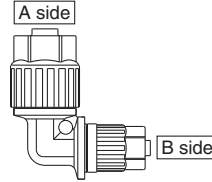

Metric sizes		
Applicable tubing O.D.		Model
A side	B side	
Ø 4	Ø 3	LQ3E11-R1
Ø 6	Ø 4	LQ3E21-R1
	Ø 3	LQ3E21-R2
Ø 10	Ø 8	LQ3E31-R1
	Ø 6	LQ3E31-R2
Ø 8	Ø 6	LQ3E32-R1
	Ø 4	LQ3E32-R2
Ø 12	Ø 10	LQ3E41-R1
	Ø 8	LQ3E41-R2
Ø 19	Ø 12	LQ3E51-R1
	Ø 10	LQ3E51-R2
Ø 25	Ø 19	LQ3E61-R1
	Ø 12	LQ3E61-R2
Inch sizes		
Applicable tubing O.D.		Model
A side	B side	
1/4"	1/8"	LQ3E2A-R1
3/8"	1/4"	LQ3E3A-R1
	1/8"	LQ3E3A-R2
1/2"	3/8"	LQ3E4A-R1
	1/4"	LQ3E4A-R2
3/4"	1/2"	LQ3E5A-R1
	3/8"	LQ3E5A-R2
	1/4"	LQ3E5A-R3
1"	3/4"	LQ3E6A-R1
	1/2"	LQ3E6A-R2

Note) For dimensions and other details refer to specific catalogue of the series at www.smc.eu

- KQ2
- KQ2-Uni
- KQB2
- KS/KX
- KM
- KF
- M
- H/DL L/LL
- KC
- KK
- KKH
- KK 130
- DM
- DMK
- KDM
- MQR
- KB
- KR-W2
- KRM
- KA
- KQG2
- KG
- KFG2
- MS
- KKA
- KP
- KPQ/KPG
- LQ1
- LQ3
- LQHB

Union tee reducing

LQ3T-R

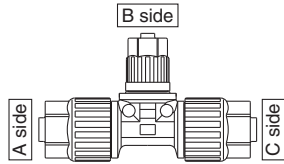

Metric sizes			
Applicable tubing O.D.			Model
A side (Left)	B side (Centre)	C side (Right)	
Ø 4	Ø 3	Ø 4	LQ3T11-R1
	Ø 4	Ø 3	LQ3T11-R5
Ø 6	Ø 4	Ø 6	LQ3T21-R1
	Ø 3	Ø 6	LQ3T21-R2
	Ø 6	Ø 4	LQ3T21-R5
	Ø 6	Ø 3	LQ3T21-R6
Ø 10	Ø 8	Ø 10	LQ3T31-R1
	Ø 6	Ø 10	LQ3T31-R2
	Ø 10	Ø 6	LQ3T31-R6
Ø 8	Ø 6	Ø 8	LQ3T32-R1
	Ø 8	Ø 6	LQ3T32-R5
Ø 12	Ø 10	Ø 12	LQ3T41-R1
	Ø 12	Ø 10	LQ3T41-R5
Ø 19	Ø 12	Ø 19	LQ3T51-R1
	Ø 19	Ø 12	LQ3T51-R5
Ø 25	Ø 19	Ø 25	LQ3T61-R1
	Ø 25	Ø 19	LQ3T61-R5
Inch sizes			
Applicable tubing O.D.			Model
A side (Left)	B side (Centre)	C side (Right)	
1/4"	1/8"	1/4"	LQ3T2A-R1
	1/4"	1/8"	LQ3T2A-R5
3/8"	1/4"	3/8"	LQ3T3A-R1
	1/8"	3/8"	LQ3T3A-R2
	3/8"	1/4"	LQ3T3A-R5
	1/4"	1/4"	LQ3T3A-R7
1/4"	3/8"	1/4"	LQ3T3A-R9
	3/8"	1/2"	LQ3T4A-R1
1/2"	1/4"	1/2"	LQ3T4A-R2
	1/2"	3/8"	LQ3T4A-R5
	1/2"	1/4"	LQ3T4A-R6
	3/8"	3/8"	LQ3T4A-R7
	1/4"	1/4"	LQ3T4A-R8
	3/8"	1/2"	3/8"
3/4"	1/2"	3/4"	LQ3T5A-R1
	3/8"	3/4"	LQ3T5A-R2
	1/4"	3/4"	LQ3T5A-R3
	3/4"	1/2"	LQ3T5A-R5
	3/4"	3/8"	LQ3T5A-R6
	1/2"	1/2"	LQ3T5A-R7
1/2"	3/4"	1/2"	LQ3T5A-R9
3/8"	3/4"	3/8"	LQ3T5A-R10
3/4"	1/2"	1/4"	LQ3T5A-R11
	3/4"	1/4"	LQ3T5A-R12
1"	3/4"	1"	LQ3T6A-R1
	1/2"	1"	LQ3T6A-R2
	3/8"	1"	LQ3T6A-R3
	1/4"	1"	LQ3T6A-R4
	1"	3/4"	LQ3T6A-R5
	1"	1/2"	LQ3T6A-R6
	3/4"	3/4"	LQ3T6A-R7
3/4"	1"	3/4"	LQ3T6A-R9
1/2"	1"	1/2"	LQ3T6A-R10
1"	1"	3/8"	LQ3T6A-R12
	1"	1/4"	LQ3T6A-R13
3/4"	1"	1/4"	LQ3T6A-R14

Tubing extension straight connector

LQ3H-T

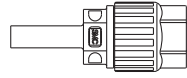

Metric sizes	
Applicable tubing O.D.	Model
Ø 6	LQ3H21-T
Ø 10	LQ3H31-T
Ø 8	LQ3H32-T
Ø 12	LQ3H41-T
Ø 19	LQ3H51-T
Ø 25	LQ3H61-T
Inch sizes	
Applicable tubing O.D.	Model
1/4"	LQ3H2A-T
3/8"	LQ3H3A-T
1/2"	LQ3H4A-T
3/4"	LQ3H5A-T
1"	LQ3H6A-T
1 1/4"	LQ3H7A-T

Note) For dimensions and other details refer to specific catalogue of the series at www.smc.eu

Straight adapter

LQ3A

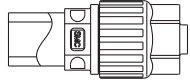

Metric sizes	
Applicable tubing size	Model
6 x 4	LQ3A21
	LQ3A22
	LQ3A23
	LQ3A24
	LQ3A25
8 x 6	LQ3A32
	LQ3A34
	LQ3A36
10 x 8	LQ3A37
8 x 6	LQ3A38
12 x 10	LQ3A41
	LQ3A42
	LQ3A43
	LQ3A44
19 x 16	LQ3A51
	LQ3A52
	LQ3A53
25 x 22	LQ3A61
	LQ3A62
	LQ3A63
Inch sizes	
Applicable tubing size	Model
1/4" x 5/32"	LQ3A2A
	LQ3A2B
	LQ3A2C
	LQ3A2D
	LQ3A2E
3/8" x 1/4"	LQ3A3A
	LQ3A3B
	LQ3A3C
1/2" x 3/8"	LQ3A4A
	LQ3A4B
	LQ3A4C
	LQ3A4D
3/4" x 5/8"	LQ3A5A
	LQ3A5B
	LQ3A5C
1" x 3/4"	LQ3A6A
	LQ3A6B
	LQ3A6C
1 1/4" x 1.1"	LQ3A7A

Union flange

LQ3F

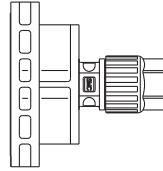

Metric sizes	
Applicable tubing size	Model
6 x 4	LQ3F22
12 x 10	LQ3F42
	LQ3F43
19 x 16	LQ3F51
	LQ3F52
25 x 22	LQ3F53
	LQ3F62
	LQ3F63
LQ3F64	
Inch sizes	
Applicable tubing size	Model
1/4" x 5/32"	LQ3F2B
1/2" x 3/8"	LQ3F4B
	LQ3F4C
3/4" x 5/8"	LQ3F5A
	LQ3F5B
	LQ3F5C
1" x 7/8"	LQ3F6B
	LQ3F6C
	LQ3F6D

Note) For dimensions and other details refer to specific catalogue of the series at www.smc.eu

KQ2

KQ2-Uni

KQB2

KS/KX

KM

KF

M

H/DL
L/LL

KC

KK

KKH

KK
130

DM

DMK

KDM

MQR

KB

KR
-W2

KRM

KA

KQG2

KG

KFG2

MS

KKA

KP

KPQ/
KPG

LQ1

LQ3

LQHB

Fluoropolymer Bore Through Connector

LQHB Series

Applicable tubing O.D.: **Metric/Inch Size**

Connection thread: **R, NPT**

Heat Resistant

Corrosion Resistant

Clean

Freely choose tube positioning

Can be used in pressure feed of chemical liquids, etc., during the production process of semiconductors. Applicable to chemical liquids such as acid, alkali, and deionised water.

As the tube runs through the fitting itself, a setting is available for any optional position.



Specifications

Max. operating pressure (at 20 °C)	1.0 MPa (Refer to Precautions 1.)
Operating temperature	0 to 200 °C (Refer to Precautions 1.)
Applicable tubing O.D.	Refer to the Combination Chart.

Precautions

1. The operating pressure or operating temperature range for each tubing size differs depending on the usage conditions. Keep the supplied fluid pressure and temperature within the range of each specification.
2. The piping should be arranged in such a way that no extraction force other than the fluid pressure should be added to the tubing.
3. Avoid using in instances where the nut is soaked in the fluid.
4. Screw in the R or NPT screw after inserting the tubing. (If the screw is screwed in first, the tubing may be hard to insert.)

Types of Use

There are presumably two different types of use for the bore through connector as indicated in conditions A and B, and the specifications will differ according to the type of use.

Condition A

- For applications including boring through panels or walls, etc.
- Atmospheric release

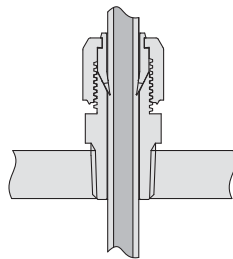

Condition B

- For applying sustained pressure to the female thread.
- Using the same pressure and temperature as that of the inside of the tube.

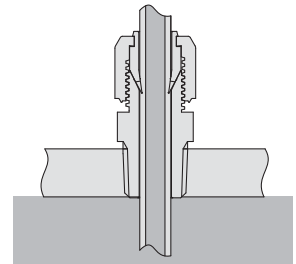

Operating range for the bore through connector

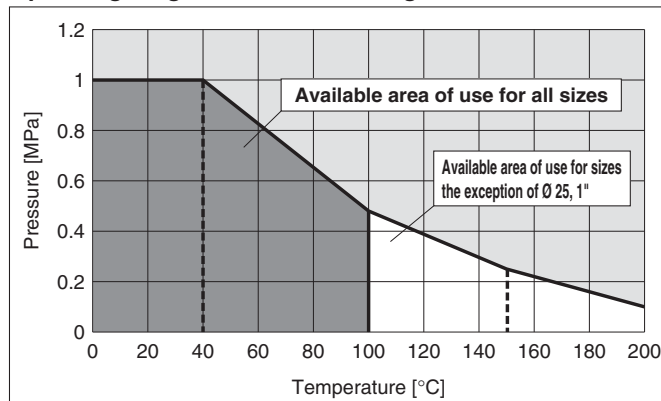

Operating range for the bore through connector

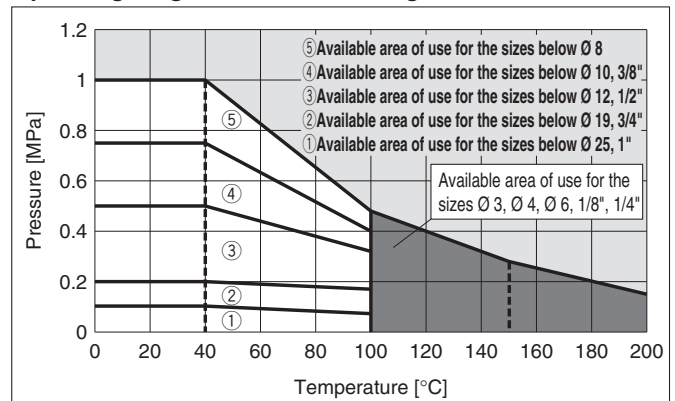

Easy tightening of nuts

- The trapezoidal thread prevents oblique nut insertion.

Taper thread

Thread type: R, NPT

Body

Material: New PFA

Locking

Trapezoidal thread allows application of high torque.



Nut

Material: New PFA

Maximum operating temperature
200 °C

Collet

The tube is held securely in place by the tightening nut and collet.
Material: PTFE

Bore through connector

LQHB

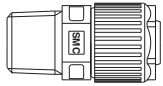

Metric size		
Applicable tubing O.D.	Connection thread R, NPT	Model
Ø 3	1/8"	LQHB03-□
Ø 4		LQHB04-□
Ø 6	1/4"	LQHB06-□
Ø 8	3/8"	LQHB08-□
Ø 10		LQHB10-□
Ø 12	1/2"	LQHB12-□
Ø 19	3/4"	LQHB19-□
Ø 25	1"	LQHB25-□
Inch size		
Applicable tubing O.D.	Connection thread R, NPT	Model
1/8"	1/8"	LQHB03-□
1/4"	1/4"	LQHB07-□
3/8"	3/8"	LQHB11-□
1/2"	1/2"	LQHB13-□
3/4"	3/4"	LQHB19-□
1"	1"	LQHB25-□











□: Nil (R), N (NPT)

Note) For dimensions and other details refer to specific catalogue of the series at www.smc.eu

- KQ2
- KQ2-Uni
- KCB2
- KS/KX
- KM
- KF
- M
- KME
- H/DL L/L
- KC
- KK
- KKH
- KK 130
- DM
- DMK
- KDM
- MQR
- KB
- KR-V2
- KRM
- KA
- KG2
- KG
- KFG2
- MS
- KKA
- KP
- KPQ/KPG
- LQ1
- LQ3
- LQHB

Speed Controllers with One-touch Fitting

Speed Controller with One-touch Fitting: Standard Type

	Model	Port size in the cylinder side	Applicable tubing O.D. Metric size [mm]							Page
			2	3.2	4	6	8	10	12	
Elbow type Push-lock type 	AS12□1F	M5	•	•	•	•	•	•	•	191
	AS22□1F	1/8, 1/4		•	•	•	•	•	•	
	AS32□1F	1/4, 3/8			•	•	•	•	•	
	AS42□1F	1/2				•	•	•	•	
Elbow type Push-lock type Face seal 	AS22□1F	1/8, 1/4		•	•	•	•	•	•	193
	AS32□1F	1/4, 3/8			•	•	•	•	•	
	AS42□1F	1/2				•	•	•	•	
With indicator/ Elbow type Push-lock type 	AS12□1FS	M5	•	•	•	•	•	•	•	196
	AS22□1FS	1/8, 1/4		•	•	•	•	•	•	
	AS32□1FS	1/4, 3/8			•	•	•	•	•	
	AS42□1SF	1/2				•	•	•	•	
Elbow type 	AS12□1F	M3	•	•	•	•	•	•	•	199
	AS12□1F	M5	•	•	•	•	•	•	•	
	AS22□1F	1/8, 1/4		•	•	•	•	•	•	
	AS32□1F	1/4, 3/8			•	•	•	•	•	
Universal type Push-lock type 	AS13□1F	M5		•	•	•	•	•	•	191
	AS23□1F	1/8, 1/4		•	•	•	•	•	•	
	AS33□1F	1/4, 3/8			•	•	•	•	•	
	AS43□1F	1/2				•	•	•	•	
Universal type Push-lock type Face seal 	AS23□1F	1/8		•	•	•	•	•	•	193
	AS23□1F	1/4			•	•	•	•	•	
	AS33□1F	1/4, 3/8			•	•	•	•	•	
	AS43□1F	1/2				•	•	•	•	
Universal type 	AS13□1F	M3		•	•	•	•	•	•	199
	AS13□1F	M5		•	•	•	•	•	•	
	AS23□1F	1/8, 1/4		•	•	•	•	•	•	
	AS33□1F	1/4, 3/8			•	•	•	•	•	
Flame Resistant (Equivalent to UL-94 Standard V-0) Elbow type 	AS22□1F	1/8, 1/4				•	•	•	•	203
	AS32□1F	1/4, 3/8				•	•	•	•	
	AS42□1F	1/2				•	•	•	•	
Plug-in type 	AS10□0P	∅ 4			•					205
	AS20□0P	∅ 4, ∅ 6			•	•				
	AS25□0P	∅ 6				•				
	AS30□0P	∅ 8, ∅ 10					•	•		
Elbow type (Metal body) 	AS12□1	M5			•	•				207
	AS22□1	1/8				•	•			
	AS22□1	1/4					•	•		
	AS32□1	3/8						•	•	

Speed Controller with One-touch Fitting: Standard Type

In-line type
Push-lock type



Model	AS1002F-□A
	AS2002F-□A
	AS2052F-□A
	AS3002F-□A
	AS4002F-□A

With indicator/
In-line type
Push-lock type



Model	AS1002FS□
	AS2002FS□
	AS2052FS□
	AS3002FS□
	AS4002FS□

In-line type



Model	AS1002F
	AS2002F
	AS2052F
	AS3002F
	AS4002F

In-line type
Panel mount type



Model	AS1001F
	AS2001F
	AS2051F
	AS3001F
	AS4001F

Centralised
piping type



Model	AS-DPP00092	Port size in the cylinder side	∅ 4
	AS-DPP00093		∅ 6

Dual speed
controller



Model	ASD230F	Port size in the cylinder side	M5
	ASD330F		1/8
	ASD430F		1/4
	ASD530F		1/4
	ASD530F		3/8
	ASD630F		1/2

Elbow type with
Uni One-touch fitting
Push-lock type



Model	AS22□1F	Port size in the cylinder side	1/8, 1/4
	AS32□1F		1/4, 3/8
	AS42□1F		1/2

With Indicator/
Elbow type/Uni thread
Push-lock type



Model	AS22□1F	Port size in the cylinder side	1/8, 1/4
	AS32□1F		1/4, 3/8
	AS42□1F		1/2

Elbow type with
Uni One-touch fitting



Model	AS22□1F	Port size in the cylinder side	1/8, 1/4
	AS32□1F		3/8
	AS42□1F		1/2

Universal type with
Uni One-touch fitting
Push-lock type



Model	AS23□1F	Port size in the cylinder side	1/8, 1/4
	AS33□1F		1/4, 3/8
	AS43□1F		1/2

Universal type with
Uni One-touch fitting



Model	AS23□1F	Port size in the cylinder side	1/8, 1/4
	AS33□1F		3/8
	AS43□1F		1/2

Speed Controller with Residual Pressure Release Valve

With One-touch
fitting/Elbow



Model	AS22□1FE	Port size in the cylinder side	1/8
	AS22□1FE		1/4
	AS32□1FE		3/8
	AS42□1FE		1/2

With One-touch
fitting/Universal













Model	AS23□1FE	Port size in the cylinder side	1/8
	AS23□1FE		1/4
	AS33□1FE		3/8
	AS43□1FE		1/2

Model	Port size in the cylinder side	Applicable tubing O.D. Metric size [mm]							Page
		2	3.2	4	6	8	10	12	
AS1002F-□A		●	●	●	●	●	●	●	195
AS2002F-□A			●	●	●	●	●	●	
AS2052F-□A				●	●	●	●	●	
AS3002F-□A					●	●	●	●	
AS4002F-□A						●	●	●	
AS1002FS□		●	●	●	●	●	●	●	198
AS2002FS□			●	●	●	●	●	●	
AS2052FS□				●	●	●	●	●	
AS3002FS□					●	●	●	●	
AS4002FS□						●	●	●	
AS1002F		●	●	●	●	●	●	●	211
AS2002F			●	●	●	●	●	●	
AS2052F				●	●	●	●	●	
AS3002F					●	●	●	●	
AS4002F						●	●	●	
AS1001F		●	●	●	●	●	●	●	212
AS2001F			●	●	●	●	●	●	
AS2051F				●	●	●	●	●	
AS3001F					●	●	●	●	
AS4001F						●	●	●	
AS-DPP00092	∅ 4			●	●	●	●	●	213
AS-DPP00093	∅ 6				●	●	●	●	
ASD230F	M5			●	●	●	●	●	214
ASD330F	1/8				●	●	●	●	
ASD430F	1/4					●	●	●	
ASD530F	1/4						●	●	
ASD530F	3/8							●	
ASD630F	1/2							●	
AS22□1F	1/8, 1/4	●	●	●	●	●	●	●	215
AS32□1F	1/4, 3/8		●	●	●	●	●	●	
AS42□1F	1/2			●	●	●	●	●	
AS22□1F	1/8, 1/4	●	●	●	●	●	●	●	217
AS32□1F	1/4, 3/8		●	●	●	●	●	●	
AS42□1F	1/2			●	●	●	●	●	
AS22□1F	1/8, 1/4	●	●	●	●	●	●	●	219
AS32□1F	3/8			●	●	●	●	●	
AS42□1F	1/2				●	●	●	●	
AS23□1F	1/8, 1/4	●	●	●	●	●	●	●	215
AS33□1F	1/4, 3/8			●	●	●	●	●	
AS43□1F	1/2				●	●	●	●	
AS23□1F	1/8, 1/4	●	●	●	●	●	●	●	219
AS33□1F	3/8			●	●	●	●	●	
AS43□1F	1/2				●	●	●	●	

Model	Port size in the cylinder side	Applicable tubing O.D. Metric size [mm]							Page
		2	3.2	4	6	8	10	12	
AS22□1FE	1/8			●	●	●	●	●	221
AS22□1FE	1/4				●	●	●	●	
AS32□1FE	3/8					●	●	●	
AS42□1FE	1/2						●	●	
AS23□1FE	1/8			●	●	●	●	●	221
AS23□1FE	1/4				●	●	●	●	
AS33□1FE	3/8					●	●	●	
AS43□1FE	1/2						●	●	

Speed Controllers

- AS
- AS-FS
- AS-1F
- AS-P
- AS-F
- AS-W2D
- AS-X737
- AS-2F
- AS-1F-3
- AS-DPP
- ASD
- Uni-AS
- Uni-AS-FS
- Uni-AS-1F
- AS-FE
- AS-FG
- AS-FSG
- AS-1FG
- ASD-FG
- ASG
- AS-FPQ/FPG
- AS-FM
- ASD-FM
- AS-F-D
- ASD-F-D
- AS-F-T
- ASD-F-T
- ASP
- ASV
- AS-R
- AS-Q
- Related

	Model	Port size in the cylinder side	Applicable tubing O.D. Metric size [mm]							Page
			2	3.2	4	6	8	10	12	
Elbow type Push-lock type 	AS12□1FG	M5	•	•	•	•	•	•	•	223
	AS22□1FG	1/8, 1/4			•	•	•	•	•	
	AS32□1FG	1/4, 3/8				•	•	•	•	
	AS42□1FG	1/2					•	•	•	
With indicator/ Elbow type Push-lock type 	AS12□1FSG	M5	•	•	•	•	•	•	•	225
	AS22□1FSG	1/8, 1/4			•	•	•	•	•	
	AS32□1FSG	1/4, 3/8				•	•	•	•	
	AS42□1FSG	1/2					•	•	•	
Elbow type 	AS12□1FG	M5			•	•	•	•	•	227
	AS22□1FG	1/8			•	•	•	•	•	
	AS22□1FG	1/4				•	•	•	•	
	AS32□1FG	1/4					•	•	•	
	AS32□1FG	3/8						•	•	
	AS42□1FG	1/2							•	
Universal type Push-lock type 	AS13□1FG	M5			•	•	•	•	•	223
	AS23□1FG	1/8, 1/4			•	•	•	•	•	
	AS33□1FG	1/4, 3/8				•	•	•	•	
	AS43□1FG	1/2					•	•	•	
Universal type 	AS13□1FG	M5			•	•	•	•	•	227
	AS23□1FG	1/8			•	•	•	•	•	
	AS23□1FG	1/4				•	•	•	•	
	AS33□1FG	1/4					•	•	•	
	AS33□1FG	3/8						•	•	
	AS43□1FG	1/2							•	
In-line type Push-lock type 	AS1002FG-□A				•	•	•	•	•	229
	AS2002FG-□A					•	•	•	•	
	AS2052FG-□A						•	•	•	
	AS3002FG-□A							•	•	
	AS4002FG-□A								•	
With indicator/ In-line type Push-lock type 	AS1002FSG□				•	•	•	•	•	230
	AS2002FSG□					•	•	•	•	
	AS2052FSG□						•	•	•	
	AS3002FSG□							•	•	
	AS4002FSG□								•	
In-line type 	AS1001FG				•	•	•	•	•	231
	AS2001FG					•	•	•	•	
	AS2051FG						•	•	•	
	AS3001FG							•	•	
	AS4001FG								•	
Dual speed controller 	ASD230FG	M5			•	•	•	•	•	232
	ASD330FG	1/8				•	•	•	•	
	ASD430FG	1/4					•	•	•	
	ASD530FG	1/4						•	•	
	ASD530FG	3/8							•	
	ASD630FG	1/2								
Elbow Type 	ASG22□F-M5	M5			•	•	•	•	•	233
	ASG32□F01	1/8				•	•	•	•	
	ASG42□F02	1/4					•	•	•	
	ASG52□F03	3/8						•	•	
	ASG62□F04	1/2							•	
Clean speed controller with One-touch fitting 	AS12□1FP□	M5			•	•	•	•	•	235
	AS22□1FP□	1/8				•	•	•	•	
	AS22□1FP□	1/4					•	•	•	
	AS32□1FP□	3/8						•	•	
	AS42□1FP□	1/2							•	

Speed Controller for Low Speed Operation

Elbow type



Model	Port size in the cylinder side	Applicable tubing O.D. Metric size [mm]							Page
		2	3.2	4	6	8	10	12	
AS12□1FM	M5		●	●	●	●	●	●	237
AS22□1FM	1/8		●	●	●	●	●	●	
AS22□1FM	1/4			●	●	●	●	●	
AS13□1FM	M5		●	●	●	●	●	●	237
AS23□1FM	1/8		●	●	●	●	●	●	
AS23□1FM	1/4			●	●	●	●	●	
AS1001FM			●	●	●	●	●	●	239
AS2001FM				●	●	●	●	●	
AS2051FM					●	●	●	●	
ASD230FM	M5			●	●	●	●	●	240
ASD330FM	1/8				●	●	●	●	
ASD430FM	1/4					●	●	●	

Universal type



In-line type



Dual speed controller



Speed Controller Adjustable by Flat Head Screwdriver

Elbow type



Model	Port size in the cylinder side	Applicable tubing O.D. Metric size [mm]							Page
		2	3.2	4	6	8	10	12	
AS12□1F-D	M5		●	●	●	●	●	●	241
AS22□1F-D	1/8, 1/4		●	●	●	●	●	●	
AS32□1F-D	1/4, 3/8			●	●	●	●	●	
AS42□1F-D	1/2				●	●	●	●	
AS13□1F-D	M5		●	●	●	●	●	●	241
AS23□1F-D	1/8, 1/4		●	●	●	●	●	●	
AS33□1F-D	1/4, 3/8			●	●	●	●	●	
AS43□1F-D	1/2				●	●	●	●	
AS1001F-D			●	●	●	●	●	●	243
AS2001F-D				●	●	●	●	●	
AS2051F-D					●	●	●	●	
AS3001F-D						●	●	●	
AS4001F-D							●	●	
ASD230F-D	M5			●	●	●	●	●	244
ASD330F-D	1/8				●	●	●	●	
ASD430F-D	1/4					●	●	●	
ASD530F-D	1/4						●	●	
ASD530F-D	3/8							●	
ASD630F-D	1/2							●	

Universal type



In-line type

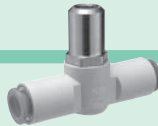

Dual speed controller



- AS
- AS-FS
- AS-1F
- AS-P
- AS-F
- AS-W2D
- AS-X737
- AS-2F
- AS-1F-3
- AS-DPP
- ASD
- Uni-AS
- Uni-AS-FS
- Uni-AS-1F
- AS-FE
- AS-FG
- AS-FSG
- AS-1FG
- ASD-FG
- ASG
- AS-FPQ/FPG
- AS-FM
- ASD-FM
- AS-F-D
- ASD-F-D
- AS-F-T
- ASD-F-T
- ASP
- ASV
- AS-R
- AS-Q
- Related

Tamper Proof Speed Controller

Elbow type



Model	Port size in the cylinder side	Applicable tubing O.D. Metric size [mm]							Page	
		2	3.2	4	6	8	10	12		16
AS12□1F-T	M5		●	●	●					245
AS22□1F-T	1/8, 1/4		●	●	●	●	●			
AS32□1F-T	1/4, 3/8			●	●	●	●	●		
AS42□1F-T	1/2				●	●	●	●	●	
AS13□1F-T	M5		●	●	●					245
AS23□1F-T	1/8, 1/4		●	●	●	●	●			
AS33□1F-T	1/4, 3/8			●	●	●	●	●		
AS43□1F-T	1/2				●	●	●	●	●	
AS1001F-T			●	●	●					247
AS2001F-T				●	●					
AS2051F-T					●	●				
AS3001F-T						●	●	●		
AS4001F-T							●	●	●	
ASD230F-T	M5			●	●					248
ASD330F-T	1/8				●	●				
ASD430F-T	1/4					●	●	●		
ASD530F-T	1/4						●	●	●	
ASD530F-T	3/8							●	●	
ASD630F-T	1/2								●	

In-line type



Dual speed controller

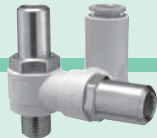

Speed Controller with Pilot Check Valve



Model	Port size in the cylinder side	Applicable tubing O.D. Metric size [mm]							Page	
		2	3.2	4	6	8	10	12		16
ASP330F-01	1/8				●	●				249
ASP430F-02	1/4					●	●			
ASP530F-03	3/8						●	●		
ASP630F-04	1/2							●	●	

Air Saving Speed Controller



Model	Port size in the cylinder side	Applicable tubing O.D. Metric size [mm]							Page	
		2	3.2	4	6	8	10	12		16
AS22R-□01-□	1/8				●	●				251
AS22R/Q-□02-□	1/4					●	●			
AS32R/Q-□02-□	1/4						●	●		
AS32R/Q-□03-□	3/8							●	●	
AS42R/Q-□03-□	3/8								●	
AS42R/Q-□04-□	1/2								●	
ASR/Q430F-02-□	1/4					●	●			252
ASR/Q530F-02-□	1/4						●	●		
ASR/Q530F-03-□	3/8							●	●	
ASR/Q630F-03-□	3/8								●	
ASR/Q630F-04-□	1/2								●	

Related Products

Holder for Speed Controller/ TMH Series



Model	Applicable tubing for speed controller	Page
Metric size		254
TMH-23J	Ø 3.2	
TMH-04J	Ø 4	
TMH-06J	Ø 6	
TMH-06	Ø 6	
TMH-08	Ø 8	
TMH-10	Ø 10	
TMH-12	Ø 12	

Residual Pressure Release Valve with One-touch Fittings /Series KE□

With One-touch fittings without a push button guard
KEA Series



Model	Port size	Page
KEA06	Ø 6	254
KEA08	Ø 8	
KEA10	Ø 10	
KEA12	Ø 12	

With One-touch fittings with a push button guard
KEB Series



Model	Port size	Page
KEB06	Ø 6	254
KEB08	Ø 8	
KEB10	Ø 10	
KEB12	Ø 12	

Rc thread with a push button guard
KEC Series



Model	Port size	Page
KEC-02	1/4	254
KEC-03	3/8	

Metering valve with silencer
ASN2 Series



Model	Port size	Page
ASN2-M5	M5	255
ASN2-01	1/8	
ASN2-02	1/4	
ASN2-03	3/8	
ASN2-04	1/2	

Multi-holder
TMA Series



Model	Page
TMA-04	254
TMA-06	
TMA-08	
TMA-10	
TMA-12	

Quick exhaust valve with One-touch fittings
AQ□F Series



Model	Applicable tubing	Page
AQ240F-04	04	255
AQ240F-06	06	
AQ340F-06	06	

Speed exhaust controller
ASV Series



Model	Port size	Page
ASV120F-M3	M3	250
ASV220F-M5	M5	
ASV310F	1/8, 1/4	
ASV410F	1/8, 1/4, 3/8	
ASV510F	1/4, 3/8, 1/2	

Bushing type check valve with One-touch fittings
Straight type,
Male connector type
AKH Series



Model	Port size	Page
AKH04	M5, 1/8	256
AKH06	M5, 1/8, 1/4	
AKH08	1/8, 1/4, 3/8	
AKH10	1/4, 3/8, 1/2	
AKH12	3/8, 1/2	

Bushing type
AKB Series



Model	Port size	Page
AKB01	1/8	256
AKB02	1/4	
AKB03	3/8	
AKB04	1/2	

Check Valve
INA/XTO Series



Model	Port size	Page
INA-14-290	1/8	256
INA-14-□	1/4, 3/8, 1/2	
XTO-674-□□	1/4, 3/8, 1/2	

- AS
- AS-FS
- AS-1F
- AS-P
- AS-F
- AS-W2D
- AS-X737
- AS-2F
- AS-1F-3
- AS-DPP
- ASD
- Uni-AS
- Uni-AS-FS
- Uni-AS-1F
- AS-FE
- AS-FG
- AS-FSG
- AS-1FG
- ASD-FG
- ASG
- AS-FPQ/
FPG
- AS-FM
- ASD-FM
- AS-F-D
- ASD-F-D
- AS-F-T
- ASD-F-T
- ASP
- ASV
- AS-R
- AS-Q
- Related

Speed Controller with One-touch Fitting RoHS

Push-lock type

AS□□□1F-A Series

Elbow Type/Universal Type

■ Applicable tubing O.D. : Metric Size ■ Connection thread : M, R

How to Order

Type

2	Elbow
3	Universal

Body size

1	M5 x 0.8
---	----------

Width across flats (H)

E Note 1)	8 mm
—	9 mm

Note 1) Not available for M3

Port size

M5	M5 x 0.8
M3 Note 1)	M3 x 0.5

Note 1) For M3, only Elbow Type available. Add "-X790" at the end.

Applicable tubing O.D. Note 1)

02	Ø 2
23	Ø 3.2 Note 2)
04	Ø 4
06	Ø 6

Note 1) For selecting applicable tubing O.D., refer to "Model" on the table below.
Note 2) Use Ø 1/8" tube.

Body size 1 AS 1 2 0 1 F - M5 E - 06 A - □

Body size 2/3/4 AS 2 2 0 1 F - 01 - 06 S A - □

Body size

2	1/8, 1/4
3	3/8
4	1/2

Port size

01	R 1/8
02	R 1/4
03	R 3/8
04	R 1/2

Control type Note)

0	Meter-out
1	Meter-in

Note) Meter-out and meter-in types can be visually identified by colour of the knob.
Meter-out: Grey
Meter-in: Light blue

Applicable tubing O.D. Note 1)

23	Ø 3.2 Note 2)
04	Ø 4
06	Ø 6
08	Ø 8
10	Ø 10
12	Ø 12
16	Ø 16

Made to Order
Refer to next page for details.

Push-lock type

Seal method

—	Without sealant
S	With sealant

Elbow type

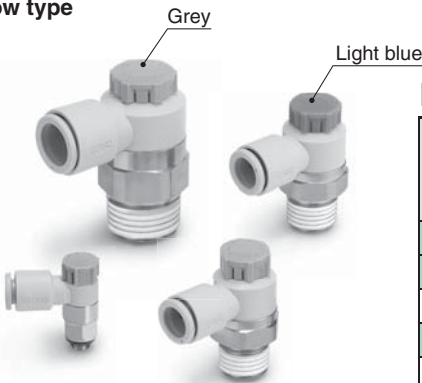

Universal type

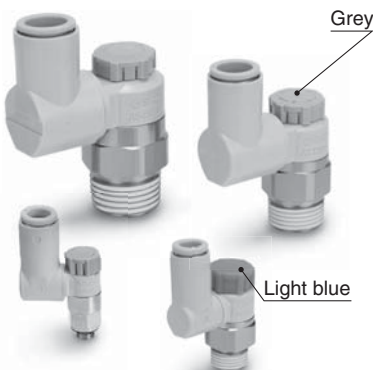

Note 1) For selecting applicable tubing O.D., refer to "Model" on the table below.
Note 2) Use Ø 1/8" tube.

Model

Port size	Applicable tubing O.D.							Elbow type		Universal type		
	Metric size							Meter-out	Meter-in	Meter-out	Meter-in	
	2 Note 2)	3.2	4	6	8	10	12	16				
M3 x 0.5	●	●	●	●					AS1201F-M3-□-X790	AS1211F-M3-□-X790	—	—
M5 x 0.8 Note 1)	●	●	●	●					AS1201F-M5E	AS1211F-M5E	AS1301F-M5E	AS1311F-M5E
R 1/8		●	●	●	●	●			AS2201F-01	AS2211F-01	AS2301F-01	AS2311F-01
R 1/4			●	●	●	●			AS2201F-02	AS2211F-02	AS2301F-02	AS2311F-02
R 1/4				●	●	●	●		AS3201F-02	AS3211F-02	AS3301F-02	AS3311F-02
R 3/8				●	●	●	●		AS3201F-03	AS3211F-03	AS3301F-03	AS3311F-03
R 1/2						●	●	● Note 1)	AS4201F-04	AS4211F-04	AS4301F-04	AS4311F-04

Note 1) Universal type is not available.
Note 2) Only polyurethane tubing is applicable for Ø 2.

Specifications

Fluid	Air
Proof pressure	1.5 MPa
Max. operating pressure	1 MPa
Min. operating pressure	0.1 MPa
Ambient and fluid temperature	-5 to 60 °C (No freezing)
Applicable tubing material	Nylon, Soft nylon, Polyurethane Note), FEP, PFA

Note) Use caution at the max. operating pressure when using soft nylon or polyurethane tubing.
(Refer to the WEB catalogue at www.smc.eu for details)

Elbow Type/Universal Type

AS□□□1F-A

Symbol
Flow Direction Symbols on Body

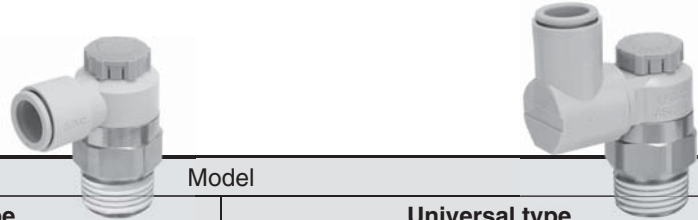
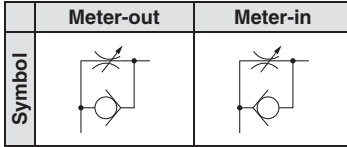

Applicable tubing O.D. [mm]	Connection thread	Model			
		Elbow type		Universal type	
		Meter-out	Meter-in	Meter-out	Meter-in
Ø 2	M5 x 0.8	AS1201F-M5E-02A	AS1211F-M5E-02A	—	—
Ø 3.2	M5 x 0.8	AS1201F-M5E-23A	AS1211F-M5E-23A	AS1301F-M5E-23A	AS1311F-M5E-23A
	R 1/8	AS2201F-01-23A	AS2211F-01-23A	AS2301F-01-23A	AS2311F-01-23A
Ø 4	M5 x 0.8	AS1201F-M5E-04A	AS1211F-M5E-04A	AS1301F-M5E-04A	AS1311F-M5E-04A
	R 1/8	AS2201F-01-04SA	AS2211F-01-04SA	AS2301F-01-04SA	AS2311F-01-04SA
	R 1/4	AS2201F-02-04SA	AS2211F-02-04SA	AS2301F-02-04SA	AS2311F-02-04SA
Ø 6	M5 x 0.8	AS1201F-M5E-06A	AS1211F-M5E-06A	AS1301F-M5E-06A	AS1311F-M5E-06A
	R 1/8	AS2201F-01-06SA	AS2211F-01-06SA	AS2301F-01-06SA	AS2311F-01-06SA
	R 1/4	AS2201F-02-06SA	AS2211F-02-06SA	AS2301F-02-06SA	AS2311F-02-06SA
		AS3201F-02-06SA	AS3211F-02-06SA	AS3301F-02-06SA	AS3311F-02-06SA
R 3/8	AS3201F-03-06SA	AS3211F-03-06SA	AS3301F-03-06SA	AS3311F-03-06SA	
Ø 8	R 1/8	AS2201F-01-08SA	AS2211F-01-08SA	AS2301F-01-08SA	AS2311F-01-08SA
	R 1/4	AS2201F-02-08SA	AS2211F-02-08SA	AS2301F-02-08SA	AS2311F-02-08SA
		AS3201F-02-08SA	AS3211F-02-08SA	AS3301F-02-08SA	AS3311F-02-08SA
R 3/8	AS3201F-03-08SA	AS3211F-03-08SA	AS3301F-03-08SA	AS3311F-03-08SA	
Ø 10	R 1/8	AS2201F-01-10SA	AS2211F-01-10SA	—	—
	R 1/4	AS2201F-02-10SA	AS2211F-02-10SA	AS2301F-02-10SA	AS2311F-02-10SA
		AS3201F-02-10SA	AS3211F-02-10SA	AS3301F-02-10SA	AS3311F-02-10SA
	R 3/8	AS3201F-03-10SA	AS3211F-03-10SA	AS3301F-03-10SA	AS3311F-03-10SA
R 1/2	AS4201F-04-10SA	AS4211F-04-10SA	AS4301F-04-10SA	AS4311F-04-10SA	
Ø 12	R 1/4	AS3201F-02-12SA	AS3211F-02-12SA	AS3301F-02-12SA	AS3311F-02-12SA
	R 3/8	AS3201F-03-12SA	AS3211F-03-12SA	AS3301F-03-12SA	AS3311F-03-12SA
	R 1/2	AS4201F-04-12SA	AS4211F-04-12SA	AS4301F-04-12SA	AS4311F-04-12SA
Ø 16	R 1/2	AS4201F-04-12SA	AS4211F-04-12SA	—	—

Refer to the WEB catalogue at www.smc.eu for inch size.

Note) For dimensions and other details refer to specific catalogue of the series at www.smc.eu



Made to Order

0 For M3 -X790

Example) AS1201F-M3-23A-X790

1 Lubricant: Vaseline -X12

Example) AS2201F-01-04SA-X12

3 Restrictor (Without check valve) -X214

Example) AS2201F-01-04SA-X214

Note) The restrictor is only compatible with the part number of the meter-out type.

2 Grease-free (Seal: Fluorine-coated) + Restrictor (Without check valve) -X21

Example) AS2201F-01-04SA-X21

Note 1) Not particle-free
Note 2) The restrictor is only compatible with the part number of the meter-out type.
Note 3) Only the needle and O-ring are fluorine-coated.

4 Clean Series 10-

Example) 10-AS2201F-01-04SA

Note 1) Fluorine grease is used.
Note 2) The particulate generation class is 5.

- AS
- AS-FS
- AS-1F
- AS-P
- AS-F
- AS-W2D
- AS-X737
- AS-2F
- AS-1F-3
- AS-DPP
- ASD
- Uni-AS
- Uni-AS-FS
- Uni-AS-1F
- AS-FE
- AS-FG
- AS-FSG
- AS-1FG
- ASD-FG
- ASG
- AS-FPQ/FPG
- AS-FM
- ASD-FM
- AS-F-D
- ASD-F-D
- AS-F-T
- ASD-F-T
- ASP
- ASV
- AS-R
- AS-Q
- Related

Speed Controller with One-touch Fitting

RoHS

Push-lock type Face seal

AS□□□1F-A Series

Elbow Type/Universal Type

■ Applicable tubing O.D. : Metric Size ■ Connection thread : G, R

How to Order

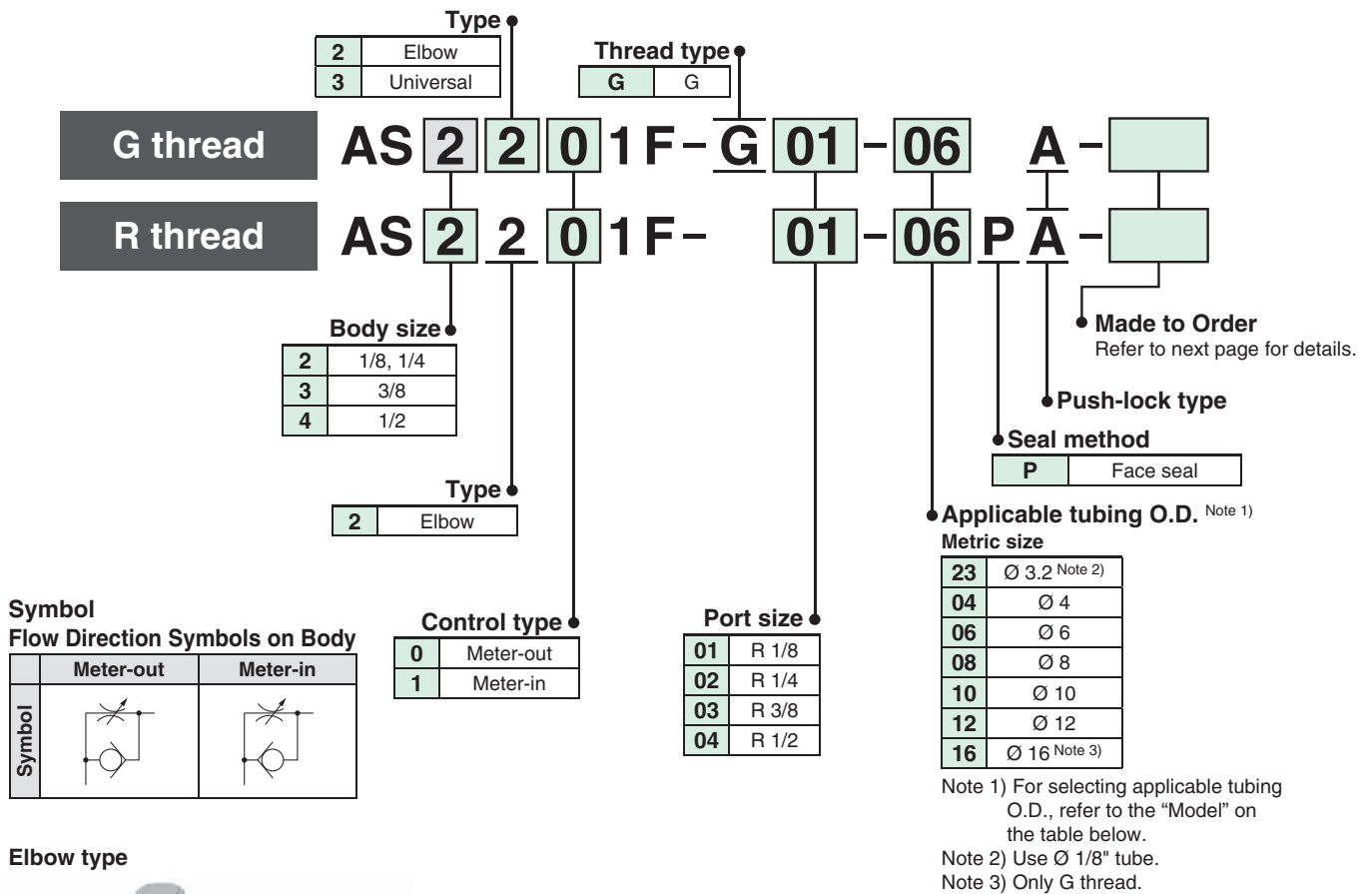

Elbow type



Universal type



Model

Port size	Applicable tubing O.D.						Elbow type		Universal type	
	Metric size						Meter-out	Meter-in	Meter-out	Meter-in
	3.2	4	6	8	10	16				
G 1/8	●	●	●	●	● ^{Note)}		AS2201F-G01	AS2211F-G01	AS2301F-G01	AS2311F-G01
G 1/4	● ^{Note)}	●	●	●	●		AS2201F-G02	AS2211F-G02	AS2301F-G02	AS2311F-G02
G 1/4			●	●	●	●	AS3201F-G02	AS3211F-G02	AS3301F-G02	AS3311F-G02
G 3/8			●	●	●	●	AS3201F-G03	AS3211F-G03	AS3301F-G03	AS3311F-G03
G 1/2					●	● ^{Note)}	AS4201F-G04	AS4211F-G04	AS4301F-G04	AS4311F-G04
R 1/8	●	●	●	●	●		AS2201F-01-□PA	AS2211F-01-□PA	—	—
R 1/4	●	●	●	●	●		AS2201F-02-□PA	AS2211F-02-□PA	—	—
R 3/8			●	●	●	●	AS3201F-03-□PA	AS3211F-03-□PA	—	—
R 1/2					●	●	AS4201F-04-□PA	AS4211F-04-□PA	—	—

Note) Universal type is not available.

Specifications

Fluid	Air
Proof pressure	1.5 MPa
Max. operating pressure	1 MPa
Min. operating pressure	0.1 MPa
Ambient and fluid temperature	-5 to 60 °C (No freezing)
Applicable tubing material	Nylon, Soft nylon, Polyurethane ^{Note)} , FEP, PFA

Note) Use caution at the max. operating pressure when using soft nylon or polyurethane tubing.
(Refer to the WEB catalogue at www.smc.eu for details)

Elbow Type/Universal Type

AS□□□1F-A

Applicable tubing O.D. [mm]	Connection thread	Model			
		Elbow type		Universal type	
		Meter-out	Meter-in	Meter-out	Meter-in
Ø 3.2	G 1/8	AS2201F-G01-23A	AS2211F-G01-23A	AS2301F-G01-23A	AS2311F-G01-23A
	G 1/4	AS2201F-G02-23A	AS2211F-G02-23A	—	—
	R 1/8	AS2201F-01-23PA	AS2211F-01-23PA	—	—
	R 1/4	AS2201F-02-23PA	AS2211F-02-23PA	—	—
Ø 4	G 1/8	AS2201F-G01-04A	AS2211F-G01-04A	AS2301F-G01-04A	AS2311F-G01-04A
	G 1/4	AS2201F-G02-04A	AS2211F-G02-04A	AS2301F-G02-04A	AS2311F-G02-04A
	R 1/8	AS2201F-01-04PA	AS2211F-01-04PA	—	—
	R 1/4	AS2201F-02-04PA	AS2211F-02-04PA	—	—
Ø 6	G 1/8	AS2201F-G01-06A	AS2211F-G01-06A	AS2301F-G01-06A	AS2311F-G01-06A
	G 1/4	AS2201F-G02-06A	AS2211F-G02-06A	AS2301F-G02-06A	AS2311F-G02-06A
		AS3201F-G02-06A	AS3211F-G02-06A	AS3301F-G02-06A	AS3311F-G02-06A
	G 3/8	AS3201F-G03-06A	AS3211F-G03-06A	AS3301F-G03-06A	AS3311F-G03-06A
	R 1/8	AS2201F-01-06PA	AS2211F-01-06PA	—	—
	R 1/4	AS2201F-02-06PA	AS2211F-02-06PA	—	—
R 3/8	AS3201F-03-06PA	AS3211F-03-06PA	—	—	
Ø 8	G 1/8	AS2201F-G01-08A	AS2211F-G01-08A	AS2301F-G01-08A	AS2311F-G01-08A
	G 1/4	AS2201F-G02-08A	AS2211F-G02-08A	AS2301F-G02-08A	AS2311F-G02-08A
		AS3201F-G02-08A	AS3211F-G02-08A	AS3301F-G02-08A	AS3311F-G02-08A
	G 3/8	AS3201F-G03-08A	AS3211F-G03-08A	AS3301F-G03-08A	AS3311F-G03-08A
	R 1/8	AS2201F-01-08PA	AS2211F-01-08PA	—	—
	R 1/4	AS2201F-02-08PA	AS2211F-02-08PA	—	—
R 3/8	AS3201F-03-08PA	AS3211F-03-08PA	—	—	
Ø 10	G 1/8	AS2201F-G01-10A	AS2211F-G01-10A	—	—
	G 1/4	AS2201F-G02-10A	AS2211F-G02-10A	AS2301F-G02-10A	AS2311F-G02-10A
		AS3201F-G02-10A	AS3211F-G02-10A	AS3301F-G02-10A	AS3311F-G02-10A
	G 3/8	AS3201F-G03-10A	AS3211F-G03-10A	AS3301F-G03-10A	AS3311F-G03-10A
	G 1/2	AS4201F-G04-10A	AS4211F-G04-10A	AS4301F-G04-10A	AS4311F-G04-10A
	R 1/8	AS2201F-01-10PA	AS2211F-01-10PA	—	—
	R 1/4	AS2201F-02-10PA	AS2211F-02-10PA	—	—
	R 3/8	AS3201F-03-10PA	AS3211F-03-10PA	—	—
R 1/2	AS4201F-04-10PA	AS4211F-04-10PA	—	—	
Ø 12	G 1/4	AS3201F-G02-12A	AS3211F-G02-12A	AS3301F-G02-12A	AS3311F-G02-12A
	G 3/8	AS3201F-G03-12A	AS3211F-G03-12A	AS3301F-G03-12A	AS3311F-G03-12A
	G 1/2	AS4201F-G04-12A	AS4211F-G04-12A	AS4301F-G04-12A	AS4311F-G04-12A
	R 3/8	AS3201F-03-12PA	AS3211F-03-12PA	—	—
	R 1/2	AS4201F-04-12PA	AS4211F-04-12PA	—	—
Ø 16	G 1/2	AS4201F-G04-16A	AS4211F-G04-16A	—	—

Refer to the WEB catalogue at www.smc.eu for inch size.

Note) For dimensions and other details refer to specific catalogue of the series at www.smc.eu



Made to Order

1 Lubricant: Vaseline **-X12**

Example) AS2201F-G01-04A-X12

2 Grease-free (Seal: Fluorine-coated) + Restrictor (Without check valve) **-X21**

Example) AS2201F-G01-04A-X21

Note 1) Not particle-free
Note 2) The restrictor is only compatible with the part number of the meter-out type.
Note 3) Only the needle and O-ring are fluorine-coated.

3 Restrictor (Without check valve) **-X214**

Example) AS2201F-G01-04A-X214

Note) The restrictor is only compatible with the part number of the meter-out type.

4 Clean Series **10-**

Example) 10-AS2201F-G01-04A

Note 1) Fluorine grease is used.
Note 2) The particulate generation class is 5.

AS
AS-FS
AS-1F
AS-P
AS-F
AS-W2D
AS-X737
AS-2F
AS-1F-3
AS-DPP
ASD
Uni-AS
Uni-AS-FS
Uni-AS-1F
AS-FE
AS-FG
AS-FSG
AS-1FG
ASD-FG
ASG
AS-FPQ/
FPG
AS-FM
ASD-FM
AS-F-D
ASD-F-D
AS-F-T
ASD-F-T
ASP
ASV
AS-R
AS-Q
Related

Speed Controller with One-touch Fitting

RoHS

Push-lock type
AS Series

In-line Type

■ Applicable tubing O.D. : Metric Size

How to Order



Flow Direction
Symbol on Body

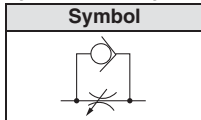

AS 200 2 F - 06 A

Body size	
100	M5 standard
200	1/8 standard
205	1/4 standard
300	3/8 standard
400	1/2 standard

With One-touch fittings

Push-lock type	Applicable tubing O.D.
	Metric size
23	Ø 3.2*1
04	Ø 4
06	Ø 6
08	Ø 8
10	Ø 10
12	Ø 12

*1: Use Ø 1/8" tubing.

Model

Model	Applicable tubing O.D.					
	Metric size					
	3.2	4	6	8	10	12
AS1002F-□A	●	●	●			
AS2002F-□A		●	●			
AS2052F-□A			●	●		
AS3002F-□A			●	●	●	●
AS4002F-□A					●	●

Specifications

Fluid	Air
Proof pressure	1.5 MPa
Max. operating pressure	1 MPa
Min. operating pressure	0.1 MPa
Ambient and fluid temperature	-5 to 60 °C (No freezing)
Applicable tubing material	Nylon, Soft nylon, Polyurethane*1, FEP, PFA

*1: Use caution at the max. operating pressure when using soft nylon or polyurethane tubing. (Refer to the catalogue at www.smc.eu for details.)

Applicable tubing O.D. [mm]	Model
Ø 3.2	AS1002F-23A
Ø 4	AS1002F-04A
	AS2002F-04A
Ø 6	AS1002F-06A
	AS2002F-06A
	AS2052F-06A
	AS3002F-06A
Ø 8	AS2052F-08A
	AS3002F-08A
Ø 10	AS3002F-10A
	AS4002F-10A
Ø 12	AS3002F-12A
	AS4002F-12A

Speed Controller with Indicator

RoHS

Speed
Controllers

AS-FS Series

Push-lock type

Elbow / Universal Type

■ Applicable tubing O.D. : Metric Size ■ Connection thread : M, R, G



How to Order

Body size 1 AS 1 2 0 1 FS [] - M5 E - 06 - []

Body size 2/3/4 AS 2 2 0 1 FS [] - [] 01 - 06 S - []

Body size

1	M5 x 0.8
---	----------

Port size

M5	M5 x 0.8
----	----------

Width across flats (H)

E	8 mm
—	9 mm

Body size

2	1/8, 1/4
3	3/8
4	1/2

Type

2	Elbow
3	Universal

Control type (Note)

0	Meter-out
1	Meter-in

With indicator

Thread type

—	R
G	G

Indicator window direction

		Elbow	Universal
—	0°	●	—
1	180°	●	●
2	90°	●	—
3	270°	●	—

Applicable tubing O.D. (Note 1)

Metric size

02	Ø 2
23	Ø 3.2 (Note 2)
04	Ø 4
06	Ø 6

Note 1) For selecting applicable tubing O.D., refer to "Model".
Note 2) Use Ø 1/8" tube.

Port size

01	R 1/8
02	R 1/4
03	R 3/8
04	R 1/2

Seal method

—	Without sealant
S	With sealant

Note) Face seal type is used for the G thread type. Select "—" : Without sealant" option.
Example) AS2201FS-G01-06

Applicable tubing O.D. (Note 1)

Metric size

23	Ø 3.2 (Note 2)	10	Ø 10
04	Ø 4	12	Ø 12
06	Ø 6	16	Ø 16
08	Ø 8		

Note 1) For selecting applicable tubing O.D., refer to "Model".
Note 2) Use Ø 1/8" tube.

Symbol

Flow Direction Symbols on Body

	Meter-out	Meter-in
Symbol		

Specifications

Fluid	Air
Proof pressure	1.5 MPa
Max. operating pressure	1 MPa
Min. operating pressure	0.1 MPa
Ambient and fluid temperature	-5 to 60 °C (No freezing)
Applicable tubing material	Nylon, Soft nylon, Polyurethane (Note), FEP, PFA

Note) Use caution at the max. operating pressure when using soft nylon or polyurethane tubing.
(Refer to the WEB catalogue at www.smc.eu for details)



AS

AS-FS

AS-1F

AS-P

AS-F

AS-W2D

AS-X737

AS-2F

AS-1F-3

AS-DPP

ASD

Uni-AS

Uni-AS-FS

Uni-AS-1F

AS-FE

AS-FG

AS-FSG

AS-1FG

ASD-FG

ASG

AS-FPQ/
FPG

AS-FM

ASD-FM

AS-F-D

ASD-F-D

AS-F-T

ASD-F-T

ASP

ASV

AS-R

AS-Q

Related

Elbow Type

AS-FS

Model

Model	Port size	Applicable tubing O.D.							
		Metric size							
		2 ^{Note 1)}	3.2	4	6	8	10	12	16
AS1□□1FS□-M5□	M5 x 0.8	● ^{Note 2)}	●	●	●				
AS1□□1FS□-U10/32□	10-32UNF	● ^{Note 2)}	●	●	●				
AS2□□1FS□-□01	R G	1/8	●	●	●	●	● ^{Note 2)}		
AS2□□1FS□-□02		1/4	● ^{Note 2)}	●	●	●	●		
AS3□□1FS□-□02		1/4			●	●	●	●	
AS3□□1FS□-□03		3/8			●	●	●	●	
AS4□□1FS□-□04		1/2					●	●	● ^{Note 2)}

Note 1) Only polyurethane tubing is applicable for Ø 2.

Note 2) Universal type is not available.



Applicable tubing O.D. [mm]	Connection thread	Model		Model	
		Elbow type		Universal type	
		Meter-out	Meter-in	Meter-out	Meter-in
Ø 2	M5 x 0.8	AS1201FS-M5E-02	AS1211FS-M5E-02	—	—
Ø 3.2	M5 x 0.8	AS1201FS-M5E-23	AS1211FS-M5E-23	AS1301FS-M5-23	AS1311FS-M5-23
	R 1/8	AS2201FS-01-23	AS2211FS-01-23	AS2301FS-01-23S	AS2311FS-01-23S
Ø 4	M5 x 0.8	AS1201FS-M5E-04	AS1211FS-M5E-04	AS1301FS-M5-04	AS1311FS-M5-04
	R 1/8	AS2201FS-01-04S	AS2211FS-01-04(S)	AS2301FS-01-04S	AS2311FS-01-04
	R 1/4	AS2201FS-02-04S	AS2211FS-02-04(S)	AS2301FS-02-04S	AS2311FS-02-04
Ø 6	M5 x 0.8	AS1201FS-M5E-06	AS1211FS-M5E-06	AS1301FS-M5-06	AS1311FS-M5-06
	R 1/8	AS2201FS-01-06S	AS2211FS-01-06(S)	AS2301FS-01-06S	AS2311FS-01-06
	R 1/4	AS2201FS-02-06S	AS2211FS-02-06(S)	AS2301FS-02-06S	AS2311FS-02-06
		AS3201FS-02-06S	AS3211FS-02-06(S)	AS3301FS-02-06S	AS3311FS-02-06
R 3/8	AS3201FS-03-06S	AS3211FS-03-06(S)	AS3301FS-03-06S	AS3311FS-03-06	
Ø 8	R 1/8	AS2201FS-01-08S	AS2211FS-01-08(S)	AS2301FS-01-08S	AS2311FS-01-08
	R 1/4	AS2201FS-02-08S	AS2211FS-02-08(S)	AS2301FS-02-08S	AS2311FS-02-08
		AS3201FS-02-08S	AS3211FS-02-08(S)	AS3301FS-02-08S	AS3311FS-02-08
	R 3/8	AS3201FS-03-08S	AS3211FS-03-08(S)	AS3301FS-03-08S	AS3311FS-03-08
Ø 10	R 1/8	AS2201FS-01-10S	AS2211FS-01-10(S)	AS2301FS-01-10S	AS2311FS-01-10
	R 1/4	AS2201FS-02-10S	AS2211FS-02-10(S)	—	—
		AS3201FS-02-10S	AS3211FS-02-10(S)	AS3301FS-02-10S	AS3311FS-02-10
	R 3/8	AS3201FS-03-10S	AS3211FS-03-10(S)	AS3301FS-03-10S	AS3311FS-03-10
R 1/2	AS4201FS-04-10S	AS4211FS-04-10(S)	AS4301FS-04-10S	AS4311FS-04-10	
Ø 12	R 1/4	AS3201FS-02-12S	AS3211FS-02-12(S)	AS3301FS-02-12S	AS3311FS-02-12
	R 3/8	AS3201FS-03-12S	AS3211FS-03-12(S)	AS3301FS-03-12S	AS3311FS-03-12
	R 1/2	AS4201FS-04-12S	AS4211FS-04-12(S)	AS4301FS-04-12S	AS4311FS-04-12
Ø 16	R 1/2	AS4201FS-04-16S	AS4211FS-04-16(S)	—	—

Refer to the WEB catalogue at www.smc.eu for inch size.

Note) For dimensions and other details refer to specific catalogue of the series at www.smc.eu



Made to Order

1 Lubricant: Vaseline -X12

Example) AS2201FS-01-04S-X12

2 Grease-free (Seal: Fluorine-coated) + Restrictor (Without check valve) -X21

Example) AS2201FS-01-04S-X21

Note 1) Not particle-free

Note 2) The restrictor is only compatible with the part number of the meter-out type.

Note 3) Only the needle and O-ring are fluorine-coated.

3 Restrictor (Without check valve) -X214

Example) AS2201FS-01-04S-X214

Note) The restrictor is only compatible with the part number of the meter-out type.

4 Clean Series 10-

Example) 10-AS2201FS-01-04S

Note 1) Fluorine grease is used.

Note 2) The particulate generation class is 5.

Speed Controller with Indicator

RoHS

Speed
Controllers

Push-lock type
AS-FS Series

In-line Type

■ Applicable tubing O.D. : Metric Size

How to Order



Flow Direction
Symbol on Body

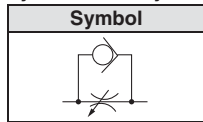

AS 200 2 F S 1 - 06

Body size

100	M5 standard
200	1/8 standard
205	1/4 standard
300	3/8 standard
400	1/2 standard

With One-touch fittings

With indicator

Applicable tubing O.D.*1

Metric size

23	∅ 3.2*1
04	∅ 4
06	∅ 6
08	∅ 8
10	∅ 10
12	∅ 12

*1: Use ∅ 1/8" tubing.

Indicator window direction

—	0°		2	90°	
1	180°		3	270°	

Model

Model	Applicable tubing O.D.					
	Metric size					
	3.2	4	6	8	10	12
AS1002FS□	●	●	●			
AS2002FS□		●	●			
AS2052FS□			●	●		
AS3002FS□			●	●	●	●
AS4002FS□					●	●

Specifications

Fluid	Air
Proof pressure	1.5 MPa
Max. operating pressure	1 MPa
Min. operating pressure	0.1 MPa
Ambient and fluid temperature	-5 to 60 °C (No freezing)
Applicable tubing material	Nylon, Soft nylon, Polyurethane*1, FEP, PFA

*1: Use caution at the max. operating pressure when using soft nylon or polyurethane tubing. (Refer to the catalogue at www.smc.eu for details.)

Applicable tubing O.D. [mm]	Model
∅ 3.2	AS1002FS-23
∅ 4	AS1002FS-04
	AS2002FS-04
∅ 6	AS1002FS-06
	AS2002FS-06
	AS2052FS-06
	AS3002FS-06
∅ 8	AS2052FS-08
	AS3002FS-08
∅ 10	AS3002FS-10
	AS4002FS-10
∅ 12	AS3002FS-12
	AS4002FS-12

AS

AS-FS

AS-1F

AS-P

AS-F

AS-W2D

AS-X737

AS-2F

AS-1F-3

AS-DPP

ASD

Uni-AS

Uni-AS-FS

Uni-AS-1F

AS-FE

AS-FG

AS-FSG

AS-1FG

ASD-FG

ASG

AS-FPQ/
FPG

AS-FM

ASD-FM

AS-F-D

ASD-F-D

AS-F-T

ASD-F-T

ASP

ASV

AS-R

AS-Q

Related

Speed Controller with One-touch Fitting

RoHS

AS□□□1F Series

Elbow Type/Universal Type

■Applicable tubing O.D. : Metric Size ■Connection thread : M, R

How to Order

AS 2 2 0 1 F - 01 - 06 S - [] - []

Body size

1	M3, M5 standard
2	1/8, 1/4 standard
3	3/8 standard
4	1/2 standard

Type

2	Elbow
3	Universal

Control type

0	Meter-out
1	Meter-in

With One-touch fitting

Port size

M3	M3 x 0.5
M5	M5 x 0.8
01	R 1/8
02	R 1/4
03	R 3/8
04	R 1/2

Applicable tubing O.D. Metric size

02	∅ 2
23	∅ 3.2*
04	∅ 4
06	∅ 6
08	∅ 8
10	∅ 10
12	∅ 12

Lock nut option

—	Hexagon lock nut
J	Round lock nut

Made to Order
Refer to page 201 for details.

Option

—	None
S	With seal
N	Electroless nickel plated

*1 If more than one option is required, write option part numbers in the order of "S", "N".
*2 M3 and M5 are not available with seals.

* Use ∅ 1/8" tube.

Elbow type



Model

Models marked with are electroless nickel plated as standard. (N specifications)

Port size	Applicable tubing O.D.							Elbow type		Universal type	
	Metric size							Meter-out	Meter-in	Meter-out	Meter-in
	2	3.2	4	6	8	10	12				
M3 x 0.5 <small>Note 1)</small>								AS1201F-M3	AS1211F-M3	AS1301F-M3	AS1311F-M3
M5 x 0.8 <small>Note 1)</small>								AS1201F-M5	AS1211F-M5	AS1301F-M5	AS1311F-M5
R 1/8							<small>Note 1)</small>	AS2201F-01	AS2211F-01	AS2301F-01	AS2311F-01
R 1/4								AS2201F-02	AS2211F-02	AS2301F-02	AS2311F-02
R 1/4								AS3201F-02	AS3211F-02	AS3301F-02	AS3311F-02
R 3/8								AS3201F-03	AS3211F-03	AS3301F-03	AS3311F-03
R 1/2								AS4201F-04	AS4211F-04	AS4301F-04	AS4311F-04

Note 1) Elbow type only

Note 2) Meter-out and meter-in types can be visually differentiated by the lock nut. The lock nut on the meter-out type is zinc chromated (the round lock nut is electroless nickel plated), while the meter-in type is black zinc chromate plated.

Universal type



Specifications

Fluid	Air
Proof pressure	1.5 MPa (1.05 MPa <small>Note 1)</small>)
Max. operating pressure	1 MPa (0.7 MPa <small>Note 1)</small>)
Min. operating pressure	0.1 MPa
Ambient and fluid temperature	-5 to 60 °C (No freezing)
Applicable tubing material <small>Note 2)</small>	Nylon, Soft nylon, Polyurethane <small>Note 3)</small>
Option	With seal <small>Note 4)</small> , Round lock nut, Electroless nickel plated <small>Note 5)</small>

Note 1) In case of AS12□1F-M3-02, AS12□1F-M5-02

Note 2) Use caution regarding the max. operating pressure when soft nylon or polyurethane tubing is used. (For details, refer to the **WEB catalogue** at www.smc.eu)

Note 3) In case of AS12□1F-M3-02 and AS12□1F-M5-02, polyurethane only.

Note 4) M3, M5 type ports are not available with seals.

Note 5) Brass parts are all electroless nickel plated.

Elbow Type/Universal Type

AS□□□1F

Symbol
Flow Direction Symbols on Body

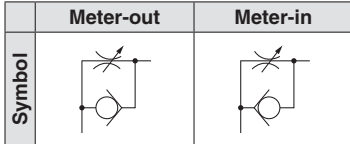

* Photo shows the model without seal.



Applicable tubing O.D. [mm]	Connection thread	Model			
		Elbow type		Universal type	
		Meter-out	Meter-in	Meter-out	Meter-in
Ø 2	M3 x 0.5	AS1201F-M3-02	AS1211F-M3-02	—	—
	M5 x 0.8	AS1201F-M5-02	AS1211F-M5-02	—	—
Ø 3.2	M3 x 0.5	AS1201F-M3-23	AS1211F-M3-23	AS1301F-M3-23	AS1311F-M3-23
	M5 x 0.8	AS1201F-M5-23	AS1211F-M5-23	AS1301F-M5-23	AS1311F-M5-23
	R 1/8	AS2201F-01-23	AS2211F-01-23	AS2301F-01-23	AS2311F-01-23
Ø 4	M3 x 0.5	AS1201F-M3-04	AS1211F-M3-04	AS1301F-M3-04	AS1311F-M3-04
	M5 x 0.8	AS1201F-M5-04	AS1211F-M5-04	AS1301F-M5-04	AS1311F-M5-04
	R 1/8	AS2201F-01-04S	AS2211F-01-04S	AS2301F-01-04S	AS2311F-01-04S
	R 1/4	AS2201F-02-04S	AS2211F-02-04S	AS2301F-02-04S	AS2311F-02-04S
Ø 6	M5 x 0.8	AS1201F-M5-06	AS1211F-M5-06	AS1301F-M5-06	AS1311F-M5-06
	R 1/8	AS2201F-01-06S	AS2211F-01-06S	AS2301F-01-06S	AS2311F-01-06S
	R 1/4	AS2201F-02-06S	AS2211F-02-06S	AS2301F-02-06S	AS2311F-02-06S
		AS3201F-02-06S	AS3211F-02-06S	AS3301F-02-06S	AS3311F-02-06S
R 3/8	AS3201F-03-06S	AS3211F-03-06S	AS3301F-03-06S	AS3311F-03-06S	
Ø 8	R 1/8	AS2201F-01-08S	AS2211F-01-08S	AS2301F-01-08S	AS2311F-01-08S
	R 1/4	AS2201F-02-08S	AS2211F-02-08S	AS2301F-02-08S	AS2311F-02-08S
		AS3201F-02-08S	AS3211F-02-08S	AS3301F-02-08S	AS3311F-02-08S
R 3/8	AS3201F-03-08S	AS3211F-03-08S	AS3301F-03-08S	AS3311F-03-08S	
Ø 10	R 1/8	AS2201F-01-10S	AS2211F-01-10S	—	—
	R 1/4	AS2201F-02-10S	AS2211F-02-10S	AS2301F-02-10S	AS2311F-02-10S
		AS3201F-02-10S	AS3211F-02-10S	AS3301F-02-10S	AS3311F-02-10S
	R 3/8	AS3201F-03-10S	AS3211F-03-10S	AS3301F-03-10S	AS3311F-03-10S
R 1/2	AS4201F-04-10S	AS4211F-04-10S	AS4301F-04-10S	AS4311F-04-10S	
Ø 12	R 1/4	AS3201F-02-12S	AS3211F-02-12S	AS3301F-02-12S	AS3311F-02-12S
	R 3/8	AS3201F-03-12S	AS3211F-03-12S	AS3301F-03-12S	AS3311F-03-12S
	R 1/2	AS4201F-04-12S	AS4211F-04-12S	AS4301F-04-12S	AS4311F-04-12S

For inch size, refer to the **WEB catalogue** at www.smc.eu

Note) For dimensions and other details refer to specific catalogue of the series at www.smc.eu

- AS
- AS-FS
- AS-1F
- AS-P
- AS-F
- AS-W2D
- AS-X737
- AS-2F
- AS-1F-3
- AS-DPP
- ASD
- Uni-AS
- Uni-AS-FS
- Uni-AS-1F
- AS-FE
- AS-FG
- AS-FSG
- AS-1FG
- ASD-FG
- ASG
- AS-FPQ/FPG
- AS-FM
- ASD-FM
- AS-F-D
- ASD-F-D
- AS-F-T
- ASD-F-T
- ASP
- ASV
- AS-R
- AS-Q
- Related



Made to Order

1 Lubricant: Vaseline X12

Example) AS2201F-01-04S-X12

2 Grease-free (Seal: Fluorine-coated) + Restrictor (Without check valve) X21

Example) AS2201F-01-04S-X21

Note 1) Not particle-free

Note 2) The restrictor is only compatible with the part number of the meter-out type.

3 Restrictor (Without check valve) X214

Example) AS2201F-01-04S-X214

Note) The restrictor is only compatible with the part number of the meter-out type.

4 Clean Series 10-

Lubricant: Fluorine-based grease Double package

Example) 10-AS2201F-01-06

5 Fixed Throttle (No needle function) X250

How to Order

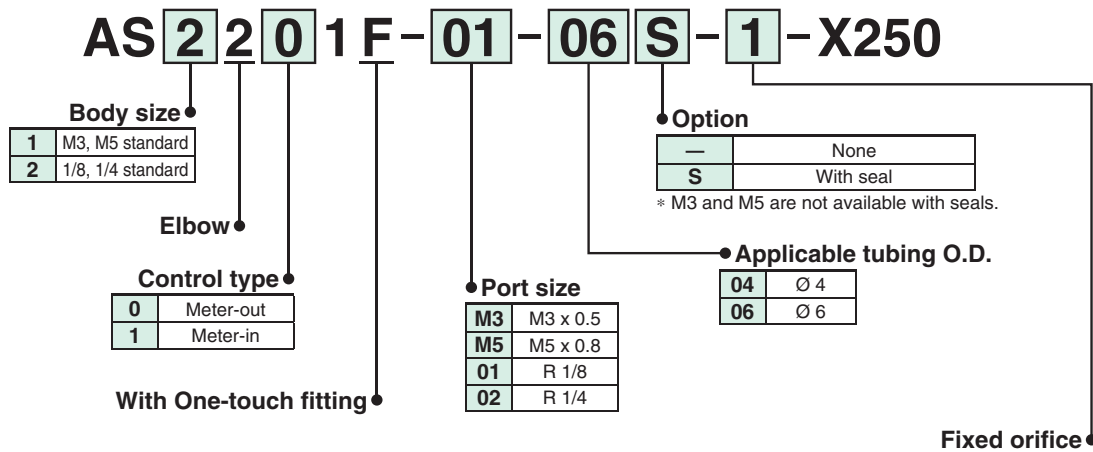

Symbol	Fixed orifice	Applicable model			
		AS12□1F-M3-04	AS12□1F-M5-04 AS12□1F-M5-06	AS22□1F-01-04 AS22□1F-01-06	AS22□1F-02-06
1	Ø 0.1	●	●	●	●
2	Ø 0.2	●	●	●	●
3	Ø 0.3	●	●	●	●
4	Ø 0.4	●	●	●	●
5	Ø 0.5	●	●	●	●
6	Ø 0.6	●	●	●	●
7	Ø 0.7	●	●	●	●
8	Ø 0.8	●	●	●	●
9	Ø 0.9		●	●	●
10	Ø 1.0		●	●	●

The graph below shows the relationship between orifices for each cylinder bore and cylinder speed. Please refer to it during selection. The cylinder speeds on the graph are theoretical values. Actual values may differ depending on the piping conditions or sliding friction, so please use this graph as a guideline only.

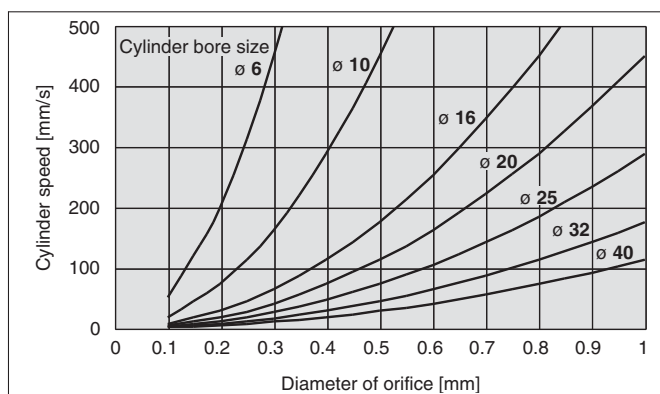

AS

AS-FS

AS-1F

AS-P

AS-F

AS-W2D

AS-X737

AS-2F

AS-1F-3

AS-DPP

ASD

Uni-
ASUni-
AS-FSUni-
AS-1F

AS-FE

AS-FG

AS-FSG

AS-1FG

ASD-FG

ASG

AS-FPQ/
FPG

AS-FM

ASD-FM

AS-F-D

ASD-F-D

AS-F-T

ASD-F-T

ASP

ASV

AS-R
AS-Q

Related

Flame Resistant (Equivalent to UL-94 Standard V-0): Speed Controller with One-touch Fittings

AS□□□1F-W2 Series

Elbow Type

■ Applicable tubing O.D. : Metric Size ■ Connection thread : R

Spatter Proof

How to Order

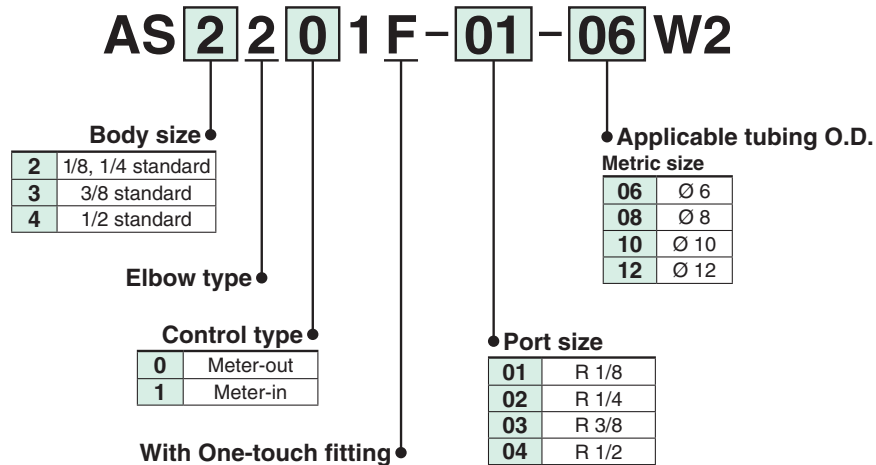

Elbow type



Model

Models marked with "●" are electroless nickel plated as standard. (N specifications)

Port size	Applicable tubing O.D.				Elbow type	
	Metric size				Meter-out	Meter-in
	6	8	10	12		
R 1/8	●	●	●		AS2201F-01-□W2	AS2211F-01-□W2
R 1/4	●	●	●		AS2201F-02-□W2	AS2211F-02-□W2
R 1/4	●	●	●	●	AS3201F-02-□W2	AS3211F-02-□W2
R 3/8	●	●	●	●	AS3201F-03-□W2	AS3211F-03-□W2
R 1/2			●	●	AS4201F-04-□W2	AS4211F-04-□W2

Note) Meter-out and meter-in types can be visually differentiated by the lock nut.

The lock nut on the meter-out type is electroless nickel plated, while the meter-in type is black zinc chromate plated.

Specifications

Fluid	Air
Proof pressure	1.5 MPa
Max. operating pressure	1 MPa
Min. operating pressure	0.1 MPa
Ambient and fluid temperature	-5 to 60 °C (No freezing)
Applicable tubing material ^{Note)}	FR double layer, FR soft nylon

Note) Use caution at the max. operating pressure when using soft nylon or polyurethane tubing.
(For details, refer to the **WEB catalogue** at www.smc.eu)

Elbow Type

AS□□□1F-W2

Symbol
Flow Direction Symbols on Body

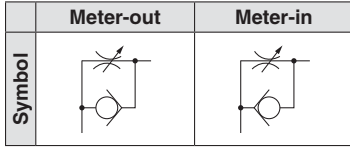

Applicable tubing O.D. [mm]	Connection thread	Model	
		Elbow type	
		Meter-out	Meter-in
Ø 6	R 1/8	AS2201F-01-06W2	AS2211F-01-06W2
	R 1/4	AS2201F-02-06W2	AS2211F-02-06W2
		AS3201F-02-06W2	AS3211F-02-06W2
R 3/8	AS3201F-03-06W2	AS3211F-03-06W2	
Ø 8	R 1/8	AS2201F-01-08W2	AS2211F-01-08W2
	R 1/4	AS2201F-02-08W2	AS2211F-02-08W2
		AS3201F-02-08W2	AS3211F-02-08W2
R 3/8	AS3201F-03-08W2	AS3211F-03-08W2	
Ø 10	R 1/8	AS2201F-01-10W2	AS2211F-01-10W2
	R 1/4	AS2201F-02-10W2	AS2211F-02-10W2
		AS3201F-02-10W2	AS3211F-02-10W2
	R 3/8	AS3201F-03-10W2	AS3211F-03-10W2
R 1/2	AS4201F-04-10W2	AS4211F-04-10W2	
Ø 12	R 1/4	AS3201F-02-12W2	AS3211F-02-12W2
	R 3/8	AS3201F-03-12W2	AS3211F-03-12W2
	R 1/2	AS4201F-04-12W2	AS4211F-04-12W2

Note) For dimensions and other details refer to specific catalogue of the series at www.smc.eu

- AS
- AS-FS
- AS·1F
- AS·P
- AS·F
- AS-W2D
- AS-X737
- AS·2F
- AS-1F-3
- AS-DPP
- ASD
- Uni-AS
- Uni-AS-FS
- Uni-AS·1F
- AS·FE
- AS·FG
- AS-FSG
- AS-1FG
- ASD-FG
- ASG
- AS-FPQ/
FPG
- AS·FM
- ASD·FM
- AS·F-D
- ASD·F-D
- AS·F-T
- ASD·F-T
- ASP
- ASV
- AS-R
- AS-Q
- Related

Speed Controller with One-touch Fitting Plug-in Type RoHS

AS□□□□P Series

Elbow Type

■ Applicable rod O.D. - tubing O.D. : Metric Size

How to Order

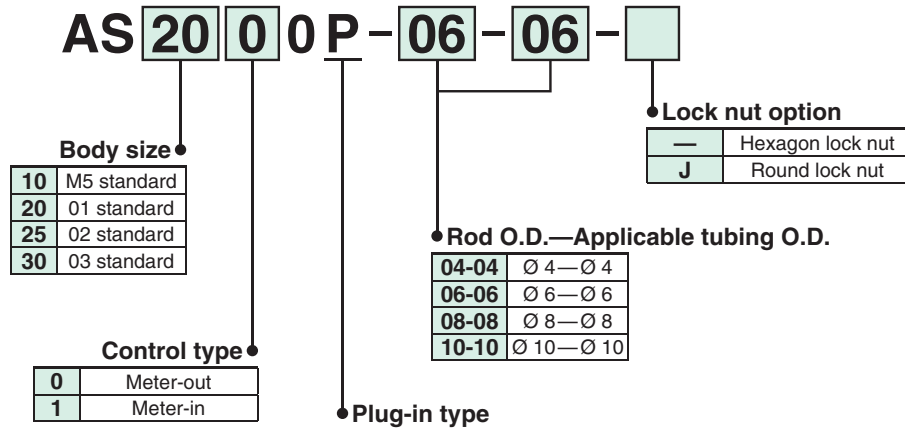

Can be mounted directly to the One-touch fitting!
No need for tools, reducing time required for mounting.

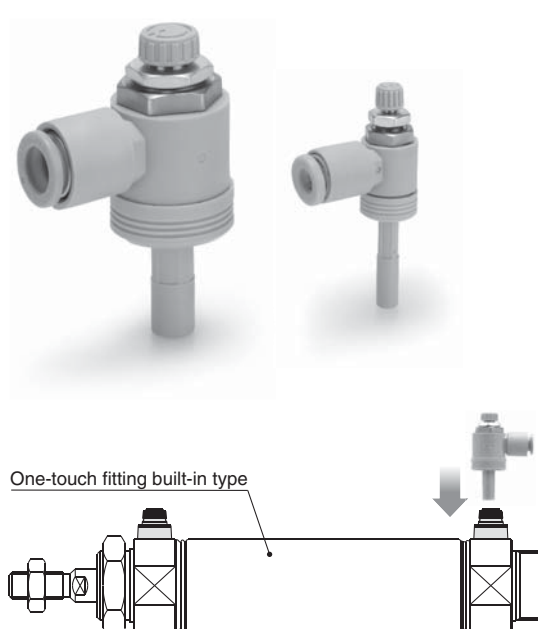

Model

Model		Rod and applicable tubing O.D.			
Meter-out	Meter-in	4	6	8	10
AS1000P-04-04	AS1010P-04-04	●	—	—	—
AS2000P-04-04	AS2010P-04-04	●	—	—	—
AS2000P-06-06	AS2010P-06-06	—	●	—	—
AS2500P-06-06	AS2510P-06-06	—	●	—	—
AS3000P-08-08	AS3010P-08-08	—	—	●	—
AS3000P-10-10	AS3010P-10-10	—	—	—	●

<Visual identification between meter-out and meter-in types>
 The lock nut provides identification. The lock nut of the meter-out type is zinc chromated (The round lock nut is electroless nickel plated), and the one of the meter-in type is black zinc chromated.

Specifications

Fluid	Air
Proof pressure	1.5 MPa
Max. operating pressure	1 MPa
Min. operating pressure	0.1 MPa
Ambient and fluid temperature	-5 to 60 °C (No freezing)
Applicable tubing material	Nylon, Soft nylon, Polyurethane

Elbow Type

AS□□□□P

Symbol
Flow Direction Symbols on Body

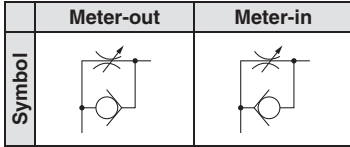

Applicable tubing O.D. [mm]	Applicable rod O.D. [mm]	Model	
		Elbow type	
		Meter-out	Meter-in
Ø 4	Ø 4	AS1000P-04-04	AS1010P-04-04
		AS2000P-04-04	AS2010P-04-04
Ø 6	Ø 6	AS2000P-06-06	AS2010P-06-06
		AS2500P-06-06	AS2510P-06-06
Ø 8	Ø 8	AS3000P-08-08	AS3010P-08-08
Ø 10	Ø 10	AS3000P-10-10	AS3010P-10-10

Note) For dimensions and other details refer to specific catalogue of the series at www.smc.eu

AS

AS-FS

AS-1F

AS·P

AS·F

AS-W2D

AS-X737

AS-2F

AS-1F-3

AS-DPP

ASD

Uni-AS

Uni-AS-FS

Uni-AS-1F

AS·FE

AS·FG

AS-FSG

AS-1FG

ASD-FG

ASG

AS-FPQ/
FPG

AS·FM

ASD·FM

AS·F-D

ASD·F-D

AS·F-T

ASD·F-T

ASP

ASV

AS-R
AS-Q

Related

Metal Body: Speed Controller with One-touch Fitting

AS□□□1-F Series

Elbow Type

■Applicable tubing O.D. : Metric Size ■Connection thread : M5, R

Spatter Proof

How to Order

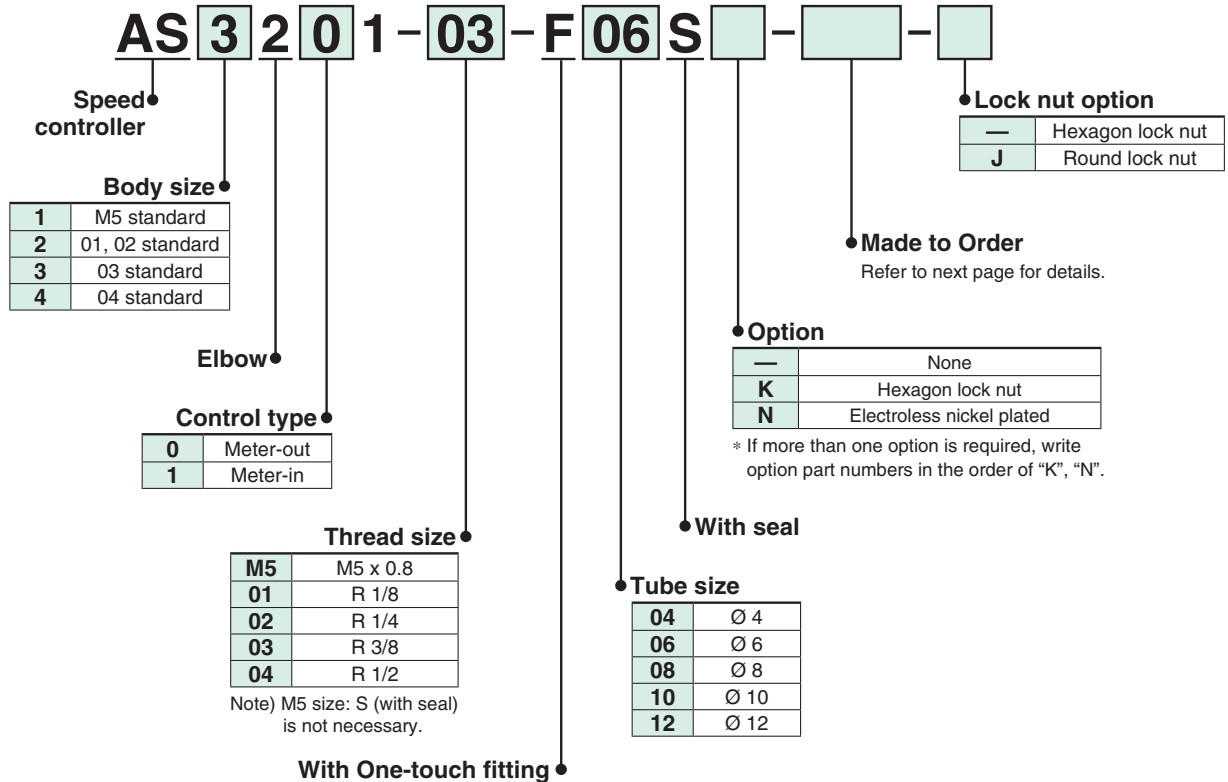

Flame resistant resin is used for One-touch fittings. (Equivalent to UL-94 Standard V-0)

Elbow type

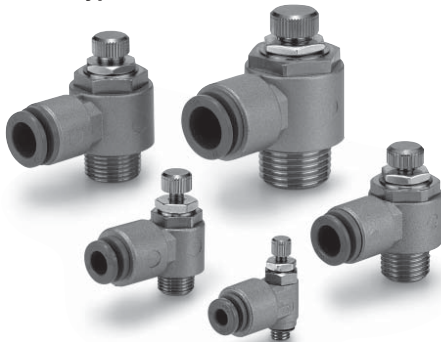

Model

Models marked with "●" are electroless nickel plated as standard. (N specifications)

Port size	Applicable tubing O.D.					Elbow type	
	Metric size					Meter-out	Meter-in
	4	6	8	10	12		
M5 x 0.8	●	●				AS1201-M5	AS1211-M5
R 1/8		●	●			AS2201-01	AS2211-01
R 1/4		●	●	●		AS2201-02	AS2211-02
R 1/4			●	●		AS3201-02	AS3211-02
R 3/8			●	●		AS3201-03	AS3211-03
R 1/2				●	●	AS4201-04	AS4211-04

Specifications

Fluid	Air
Proof pressure	1.5 MPa
Max. operating pressure	1 MPa
Min. operating pressure	0.1 MPa
Ambient and fluid temperature	-5 to 60 °C (No freezing)
Applicable tubing material	Nylon, Soft nylon, Polyurethane
Option	Hexagon lock nut, Electroless nickel plated ^{Note)}

Meter-out and meter-in types can be visually differentiated by the lock nut.

The lock nut on the meter-out type is electroless nickel plated, while the meter-in type is black zinc chromate plated.

Note) Brass parts are all electroless nickel plated.

Elbow Type

AS□□□1-F

Symbol

Flow Direction Symbols on Body

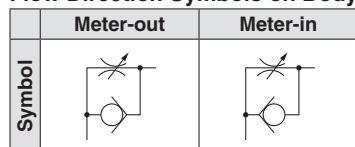

Applicable tubing O.D. [mm]	Connection thread	Model	
		Elbow type	
		Meter-out	Meter-in
Ø 4	M5 x 0.8	AS1201-M5-F04	AS1211-M5-F04
Ø 6	M5 x 0.8	AS1201-M5-F06	AS1211-M5-F06
	R 1/8	AS2201-01-F06S	AS2211-01-F06S
	R 1/4	-02-F06S	-02-F06S
Ø 8	R 1/8	AS2201-01-F08S	AS2211-01-F08S
	R 1/4	-02-F08S	-02-F08S
	R 1/4	AS3201-02-F08S	AS3211-02-F08S
	R 3/8	-03-F08S	-03-F08S
Ø 10	R 1/4	AS2201-02-F10S	AS2211-02-F10S
	R 1/4	AS3201-02-F10S	AS3211-02-F10S
	R 3/8	-03-F10S	-03-F10S
	R 1/2	AS4201-04-F10S	AS4211-04-F10S
Ø 12	R 1/2	AS4201-04-F12S	AS4211-04-F12S

Note) For dimensions and other details refer to specific catalogue of the series at www.smc.eu



Made to Order

1 Lubricant: Vaseline

X12

Example) AS1201-M5-F04-X12

2 Grease-free (Seal: Fluorine-coated)
+ Restrictor (Without check valve)

X21

Example) AS1201-M5-F04-X21

Note 1) Not particle-free

Note 2) The restrictor is only compatible with the part number of the meter-out type.

3 Restrictor (Without check valve)

X214

Example) AS1201-M5-F04-X214

Note) The restrictor is only compatible with the part number of the meter-out type.

AS

AS-FS

AS-1F

AS-P

AS-F

AS-W2D

AS-X737

AS-2F

AS-1F-3

AS-DPP

ASD

Uni-AS

Uni-AS-FS

Uni-AS-1F

AS-FE

AS-FG

AS-FSG

AS-1FG

ASD-FG

ASG

AS-FPQ/
FPG

AS-FM

ASD-FM

AS-F-D

ASD-F-D

AS-F-T

ASD-F-T

ASP

ASV

AS-R
AS-Q

Related

AS□2□1F-W2D Series

Elbow Type

■ Applicable tubing O.D. : Metric Size

■ Connection thread : G

How to Order



AS 2 2 0 1 F - G 01 - 06 W2D

Body size

2	1/8, 1/4 standard
3	3/8 standard
4	1/2 standard

Elbow

Control method

0	Meter-out
1	Meter-in

With One-touch fitting

Thread type

G	G thread
---	----------

Port size

01	1/8
02	1/4
03	3/8
04	1/2

● Flame resistant flat head screwdriver adjustable Equivalent to UL-94 standard V-O

● Applicable tubing O.D.*1

Metric size

06	Ø 6
08	Ø 8
10	Ø 10
12	Ø 12

*1 For selecting applicable tubing O.D., refer to the Model shown above.

Model

Elbow type	Port size	Applicable tubing O.D.			
		Ø 6	Ø 8	Ø 10	Ø 12
AS22□1F-G01-□W2D	G 1/8	●	●	●	
AS22□1F-G02-□W2D	G 1/4	●	●	●	
AS32□1F-G03-□W2D	G 3/8		●	●	●
AS42□1F-G04-□W2D	G 1/2			●	●

Specifications

Fluid	Air
Proof pressure	1.5 MPa
Max. operating pressure	1 MPa
Min. operating pressure	0.1 MPa
Ambient and fluid temperature	-5 to 60 °C (No freezing)
Applicable tubing material	FR double layer, FR soft nylon

*1: Use caution at the max. operating pressure when using soft nylon or polyurethane tubing. (Refer to the catalogue at www.smc.eu for details.)

Applicable tubing O.D. [mm]	Model	
	Meter-out	Meter-in
Ø 6	AS2201F-G01-06W2D	AS2211F-G01-06W2D
	AS2201F-G02-06W2D	AS2211F-G02-06W2D
Ø 8	AS2201F-G01-08W2D	AS2211F-G01-08W2D
	AS2201F-G02-08W2D	AS2211F-G02-08W2D
	AS3201F-G03-08W2D	AS3211F-G03-08W2D
Ø 10	AS2201F-G01-10W2D	AS2211F-G01-10W2D
	AS2201F-G02-10W2D	AS2211F-G02-10W2D
	AS3201F-G03-10W2D	AS3211F-G03-10W2D
	AS4201F-G04-10W2D	AS4211F-G04-10W2D
Ø 12	AS3201F-G03-12W2D	AS3211F-G03-12W2D
	AS4201F-G04-12W2D	AS4211F-G04-12W2D

All Metal Exterior Speed Controller

AS-X737 Series

Elbow Type

■ Applicable tubing O.D. : Metric Size ■ Connection thread : R

How to Order



AS 3 2 0 1 - 03 - F 08 S - X737

Body size

2	1/8, 1/4 standard
3	3/8 standard

Control type

0	Meter-out
1	Meter-in

Thread size

01	R 1/8
02	R 1/4
03	R 3/8

• With sealant

All metal exterior

• Applicable tubing O.D. (Note)

06	Ø 6
08	Ø 8
10	Ø 10

Note) For selecting applicable tubing O.D., refer to the "Model".

• With One-touch fitting

Model

Elbow type	Port size	Applicable tubing O.D.		
		Ø 6	Ø 8	Ø 10
AS22□1-01-F□S-X737	G 1/8	●	●	
AS22□1-02-F□S-X737	G 1/4	●	●	●
AS32□1-03-F□S-X737	G 3/8		●	●

Specifications

Fluid	Air
Proof pressure	1.5 MPa
Max. operating pressure	1 MPa
Min. operating pressure	0.1 MPa
Ambient and fluid temperature	-5 to 60 °C (No freezing)
Applicable tubing material	Nylon, Soft nylon, Polyurethane FR double layer, FR Three-layer, FR soft nylon

*1: Use caution at the max. operating pressure when using soft nylon or polyurethane tubing. (Refer to the catalogue at www.smc.eu for details.)

Applicable tubing O.D. [mm]	Model	
	Meter-out	Meter-in
Ø 6	AS2201-01-F06S-X737	AS2211-01-F06S-X737
	AS2201-02-F06S-X737	AS2211-02-F06S-X737
Ø 8	AS2201-01-F08S-X737	AS2211-01-F08S-X737
	AS2201-02-F08S-X737	AS2211-02-F08S-X737
	AS3201-03-F08S-X737	AS3211-03-F08S-X737
Ø 10	AS2201-02-F10S-X737	AS2211-02-F10S-X737
	AS3201-03-F10S-X737	AS3211-03-F10S-X737

AS

AS-FS

AS-1F

AS-P

AS-F

AS-W2D

AS-X737

AS-2F

AS-1F-3

AS-DPP

ASD

Uni-AS

Uni-AS-FS

Uni-AS-1F

AS-FE

AS-FG

AS-FSG

AS-1FG

ASD-FG

ASG

AS-FPQ/
FPG

AS-FM

ASD-FM

AS-F-D

ASD-F-D

AS-F-T

ASD-F-T

ASP

ASV

AS-R
AS-Q

Related

Speed Controller with One-touch Fittings RoHS

AS□2F Series

In-line Type

■ Applicable tubing O.D. : Metric Size

How to Order

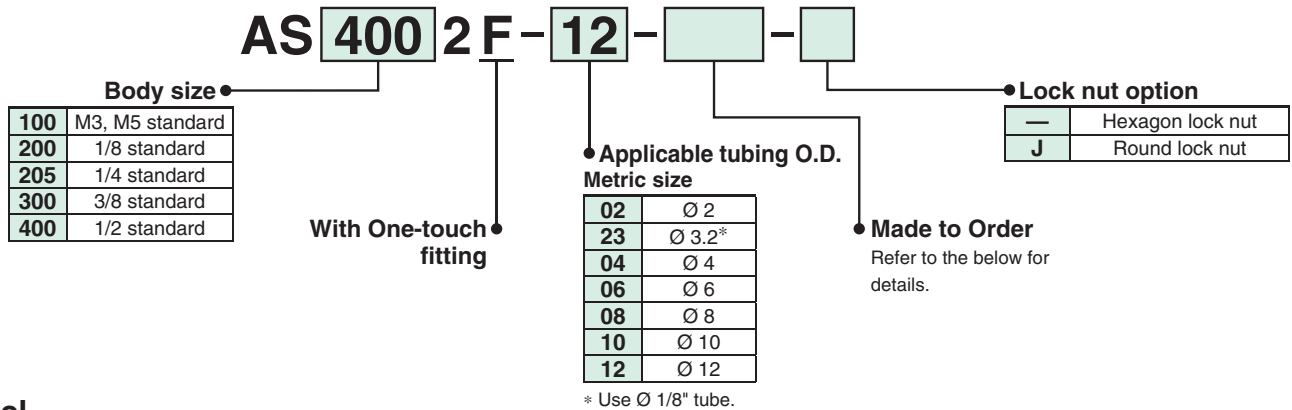

Model

Models marked with "●" are electroless nickel plated as standard. (N specifications)

Model	Applicable tubing O.D.						
	Metric size						
	2	3.2	4	6	8	10	12
AS1002F	●	●	●	●			
AS2002F			●	●			
AS2052F				●	●		
AS3002F				●	●	●	●
AS4002F						●	●

Specifications

Fluid	Air
Proof pressure	1.5 MPa (1.05 MPa)
Max. operating pressure	1 MPa (0.7 MPa)
Min. operating pressure	0.1 MPa
Ambient and fluid temperature	-5 to 60 °C (No freezing)
Applicable tubing material ^(Note 1)	Nylon, Soft nylon, Polyurethane

Note 1) Use caution at the max. operating pressure when using soft nylon or polyurethane tubing. (For details, refer to the **WEB catalogue** at www.smc.eu)

Note 2) Brass parts are all electroless nickel plated.

In-line Type

AS□2F

In-line type



Symbol



Applicable tubing O.D. [mm]	In-line type
	Model
Ø 2	AS1002F-02
	AS1002F-23
Ø 4	AS1002F-04
	AS2002F-04
Ø 6	AS1002F-06
	AS2002F-06
	AS2052F-06
	AS3002F-06

Applicable tubing O.D. [mm]	In-line type
	Model
Ø 8	AS2052F-08
	AS3002F-08
Ø 10	AS3002F-10
	AS4002F-10
Ø 12	AS3002F-12
	AS4002F-12

For inch size, refer to the **WEB catalogue** at www.smc.eu

Made to Order

Made to Order

1 Lubricant: Vaseline

X12

Example) AS2002F-04-X12

3 Restrictor (Without check valve)

X214

Example) AS2002F-04-X214

2 Grease-free (Seal: Fluorine-coated) + Restrictor (Without check valve)

X21

Example) AS2002F-04-X21

Note) Not particle-free

Speed Controller with One-touch Fittings RoHS

AS□1F-3 Series

In-line Type/Panel Mount Type

■ Applicable tubing O.D. : Metric Size

How to Order

AS 200 1 F - 06 - 3 - [] - []

Body size

100	M5 standard
200	1/8 standard
205	1/4 standard
300	3/8 standard
400	1/2 standard

Applicable tubing O.D. Metric size

23	∅ 3.2*
04	∅ 4
06	∅ 6
08	∅ 8
10	∅ 10
12	∅ 12

* Use ∅ 1/8" tube.

Panel mount type

Panel mount thickness: 3.5 mm at the maximum

Lock nut option

—	Hexagon lock nut
J	Round lock nut

With One-touch fitting

Made to Order
Refer to the below for details.

Model

Model	Applicable tubing O.D.					
	Metric size					
	3.2	4	6	8	10	12
AS1001F	●	●	●			
AS2001F		●	●			
AS2051F			●	●		
AS3001F			●	●	●	●
AS4001F					●	●

Specifications

Fluid	Air
Proof pressure	1.5 MPa
Max. operating pressure	1 MPa
Min. operating pressure	0.1 MPa
Ambient and fluid temperature	-5 to 60 °C (No freezing)
Applicable tubing material <small>Note 1)</small>	Nylon, Soft nylon, Polyurethane

Note 1) Use caution at the max. operating pressure when using soft nylon or polyurethane tubing. (For details, refer to the **WEB catalogue** at www.smc.eu)

Note 2) Brass parts are all electroless nickel plated.

In-line Type/Panel Mount Type

AS□1F-3

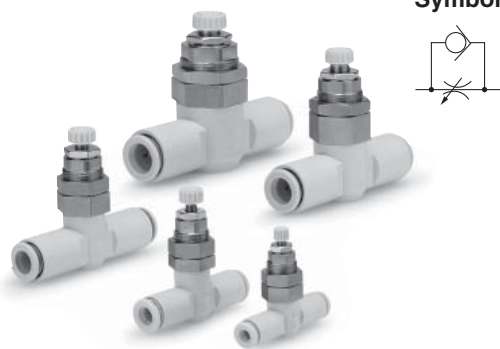

Symbol



Applicable tubing O.D. [mm]	In-line type/Panel mount type
	Model
∅ 3.2	AS1001F-23-3
	AS1001F-04-3
∅ 4	AS2001F-04-3
	AS1001F-06-3
∅ 6	AS2001F-06-3
	AS2051F-06-3
	AS3001F-06-3
	AS3001F-06-3

Applicable tubing O.D. [mm]	In-line type/Panel mount type
	Model
∅ 8	AS2051F-08-3
	AS3001F-08-3
∅ 10	AS3001F-10-3
	AS4001F-10-3
∅ 12	AS3001F-12-3
	AS4001F-12-3

For inch size, refer to the **WEB catalogue** at www.smc.eu

Made to Order

Made to Order

1 Lubricant: Vaseline

X12

Example) AS2001F-04-X12

2 Grease-free (Seal: Fluorine-coated) + Restrictor (Without check valve)

X21

Example) AS2001F-04-X21

Note) Not particle-free

3 Restrictor (Without check valve)

X214

Example) AS2001F-04-X214

Speed Controller with One-touch Fittings

AS-DPP00092/00093 Series

Centralised Piping Type

■ Applicable tubing O.D. : Metric Size

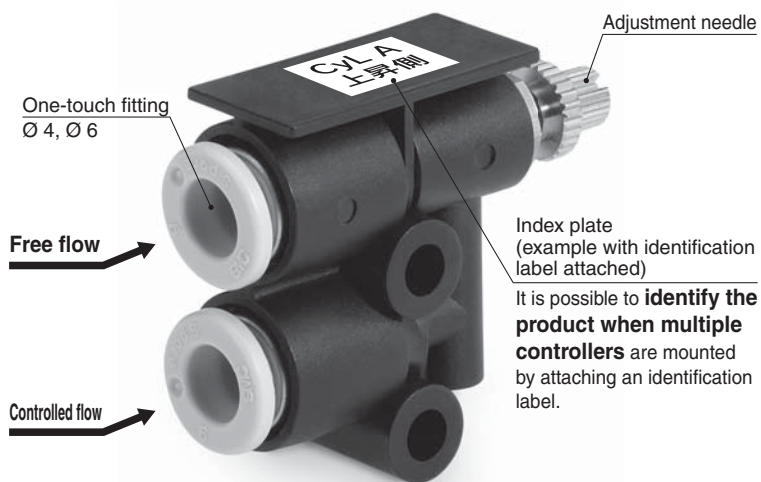

Installation example

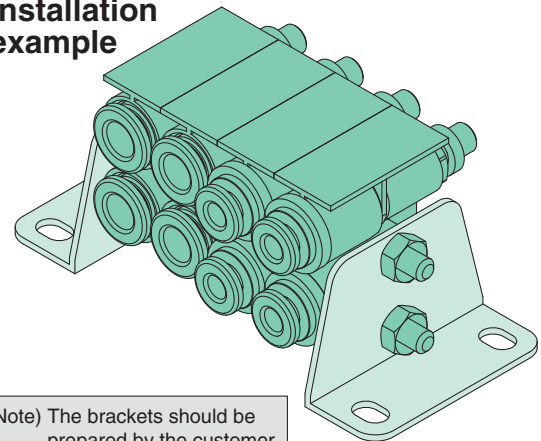

Model

Model	Applicable tubing O.D.	
	Metric size	
	4	6
AS-DPP00092	●	—
AS-DPP00093	—	●

Specifications

Fluid	Air
Proof pressure	1.5 MPa
Max. operating pressure	1 MPa (0.7 MPa ^{Note 1)})
Min. operating pressure	0.1 MPa
Ambient and fluid temperature	-5 to 60 °C (No freezing)
Applicable tubing material ^{Note 1)}	Nylon, Soft nylon, Polyurethane

Note 1) Use caution at the max. operating pressure when using soft nylon or polyurethane tubing.

(Refer to the **WEB catalogue** at www.smc.eu for details)

Note 2) Brass parts are all electroless nickel plated.

Dual Speed Controller with One-touch Fitting

RoHS

Speed
Controllers

ASD□30F series

Universal Type

■Applicable tubing O.D. : Metric Size ■Connection thread : M5, R

Lurch Prevention

How to Order

ASD **3** **30F** - **01** - **06** S - [] - []

Body size

2	M5 standard
3	1/8 standard
4	1/4 standard
5	3/8 standard
6	1/2 standard

Universal

With One-touch fitting

Port size

M5	M5 x 0.8
01	R 1/8
02	R 1/4
03	R 3/8
04	R 1/2

Applicable tubing O.D.

Metric size

04	Ø 4
06	Ø 6
08	Ø 8
10	Ø 10
12	Ø 12

Lock nut option

—	Hexagon lock nut
J	Round lock nut

Made to Order

X12	Lubricant: Vaseline
-----	---------------------

Example) ASD330F-01-06S-X12

With seal ^{Note)}
Note) M5 size: S (with seal) is not necessary.

Model

Model	Port size	Applicable tubing O.D.				
		Metric size				
		4	6	8	10	12
ASD230F-M5	M5 x 0.8	●	●			
ASD330F-01	R 1/8		●	●		
ASD430F-02	R 1/4		●	●	●	
ASD530F-02	R 1/4		●	●	●	●
ASD530F-03	R 3/8		●	●	●	●
ASD630F-04	R 1/2				●	●

Specifications

Fluid	Air
Proof pressure	1.5 MPa
Max. operating pressure	1 MPa
Min. operating pressure	0.1 MPa
Ambient and fluid temperature	-5 to 60 °C (No freezing)
Applicable tubing material ^{Note 2)}	Nylon, Soft nylon, Polyurethane
Option	Round lock nut

Note 1) In case of ASD230F

Note 2) Use caution at the max. operating pressure when using soft nylon or polyurethane tubing. (For details, refer to the **WEB catalogue** at www.smc.eu)

Note 3) Brass parts are all electroless nickel plated.

The lock nut on the meter-out type is zinc chromated (the round lock nut is electroless nickel plated), while the meter-in type is black zinc chromate plated.

Universal Type

ASD□30F

Meter-in/Meter-out control type
Prevention of a stick-slip phenomenon, and
speed control of a single acting cylinder.

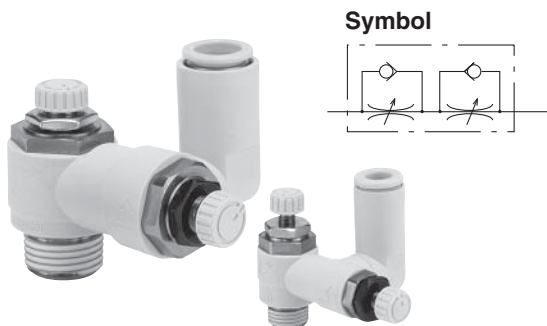

Applicable tubing O.D. [mm]	Connection thread	Model
		Universal type
Ø 4	M5 x 0.8	ASD230F-M5-04
	M5 x 0.8	ASD230F-M5-06
Ø 6	R 1/8	ASD330F-01-06S
	R 1/4	ASD430F-02-06S
		ASD530F-02-06S
	R 3/8	ASD530F-03-06S
	R 1/8	ASD330F-01-08S
Ø 8	R 1/4	ASD430F-02-08S
		ASD530F-02-08S
	R 3/8	ASD530F-03-08S

Applicable tubing O.D. [mm]	Connection thread	Model
		Universal type
Ø 10	R 1/4	ASD430F-02-10S
		ASD530F-02-10S
	R 3/8	ASD530F-03-10S
	R 1/2	ASD630F-04-10S
Ø 12	R 1/4	ASD530F-02-12S
	R 3/8	ASD530F-03-12S
	R 1/2	ASD630F-04-12S

For inch size, refer to the **WEB catalogue** at www.smc.eu

Made to Order

Made to Order

1 Lubricant: Vaseline

X12

2 Clean Series

10-

Example) ASD230F-M5-04-X12

Lubricant: Fluorine-based grease, Double package
Example) 10-ASD230F-M5-04

AS
AS-FS
AS-1F
AS-P
AS-F
AS-W2D
AS-X737
AS-2F
AS-1F-3
AS-DPP
ASD
Uni-AS
Uni-AS-FS
Uni-AS-1F
AS-FE
AS-FG
AS-FSG
AS-1FG
ASD-FG
ASG
AS-FPQ/
FPG
AS-FM
ASD-FM
AS-F-D
ASD-F-D
AS-F-T
ASD-F-T
ASP
ASV
AS-R
AS-Q
Related

Speed Controller with Uni One-touch Fitting

AS□□□1F-U□-A Series

Push-lock type

Elbow Type/Universal Type

■ Applicable tubing O.D. : Metric Size ■ Connection thread : Uni

How to Order

AS 2 2 0 1 F - U01 - 06 A

Body size

2	1/8, 1/4
3	3/8
4	1/2

Type

2	Elbow
3	Universal

Control type

0	Meter-out
1	Meter-in

Note) Meter-out and meter-in types can be visually identified by colour of the knob.
Meter-out: Grey
Meter-in: Light blue

With One-touch fitting

Port size

U01	Uni 1/8
U02	Uni 1/4
U03	Uni 3/8
U04	Uni 1/2

Push-lock type

Applicable tubing O.D. Note 1)

Metric size

Tubing O.D.	
23	Ø 3.2 <small>Note 2)</small>
04	Ø 4
06	Ø 6
08	Ø 8
10	Ø 10
12	Ø 12
16	Ø 16

Note 1) For selecting applicable tubing O.D., refer to "Model" on the table below.
Note 2) Use Ø 1/8" tube.



Model

Connection thread Uni thread	Applicable tubing O.D.						Elbow type		Universal type	
	Metric size						Meter-out	Meter-in	Meter-out	Meter-in
	3.2	4	6	8	10	12				
1/8	●	●	●	●	● <small>Note)</small>		AS2201F-U01	AS2211F-U01	AS2301F-U01	AS2311F-U01
1/4	● <small>Note)</small>	●	●	●	●		AS2201F-U02	AS2211F-U02	AS2301F-U02	AS2311F-U02
1/4			●	●	●	●	AS3201F-U02	AS3211F-U02	AS3301F-U02	AS3311F-U02
3/8			●	●	●	●	AS3201F-U03	AS3211F-U03	AS3301F-U03	AS3311F-U03
1/2					●	● <small>Note)</small>	AS4201F-U04	AS4211F-U04	AS4301F-U04	AS4311F-U04

Note) Universal type is not available.

Specifications

Fluid	Air
Proof pressure	1.5 MPa
Max. operating pressure	1 MPa
Min. operating pressure	0.1 MPa
Ambient and fluid temperature	-5 to 60 °C (No freezing)
Applicable tubing material	Nylon, Soft nylon, Polyurethane <small>Note)</small>

Note) Use caution at the max. operating pressure when using soft nylon or polyurethane tubing.
(Refer to the WEB catalogue at www.smc.eu for details.)

Refer to the WEB catalogue at www.smc.eu for inch size.

Elbow Type/Universal Type

AS□□□1F-U□-A

Symbol
Flow Direction Symbols on Body

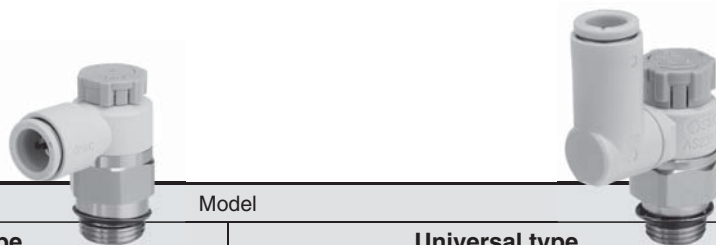
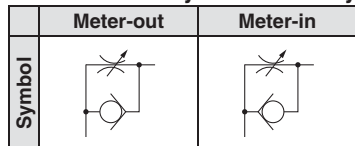

Applicable tubing O.D. [mm]	Uni thread	Model			
		Elbow type		Universal type	
		Meter-out	Meter-in	Meter-out	Meter-in
Ø 3.2	1/8	AS2201F-U01-23	AS2211F-U01-23	AS2301F-U01-23	AS2311F-U01-23
Ø 4	1/8	AS2201F-U01-04	AS2211F-U01-04	AS2301F-U01-04	AS2311F-U01-04
	1/4	AS2201F-U02-04	AS2211F-U02-04	AS2301F-U02-04	AS2311F-U02-04
Ø 6	1/8	AS2201F-U01-06	AS2211F-U01-06	AS2301F-U01-06	AS2311F-U01-06
	1/4	AS2201F-U02-06	AS2211F-U02-06	AS2301F-U02-06	AS2311F-U02-06
		AS3201F-U02-06	AS3211F-U02-06	AS3301F-U02-06	AS3311F-U02-06
	3/8	AS3201F-U03-06	AS3211F-U03-06	AS3301F-U03-06	AS3311F-U03-06
Ø 8	1/8	AS2201F-U01-08	AS2211F-U01-08	AS2301F-U01-08	AS2311F-U01-08
	1/4	AS2201F-U02-08	AS2211F-U02-08	AS2301F-U02-08	AS2311F-U02-08
		AS3201F-U02-08	AS3211F-U02-08	AS3301F-U02-08	AS3311F-U02-08
	3/8	AS3201F-U03-08	AS3211F-U03-08	AS3301F-U03-08	AS3311F-U03-08
Ø 10	1/8	AS2201F-U01-10	AS2211F-U01-10	—	—
	1/4	AS2201F-U02-10	AS2211F-U02-10	AS2301F-U02-10	AS2311F-U02-10
		AS3201F-U02-10	AS3211F-U02-10	AS3301F-U02-10	AS3311F-U02-10
	3/8	AS3201F-U03-10	AS3211F-U03-10	AS3301F-U03-10	AS3311F-U03-10
	1/2	AS4201F-U04-10	AS4211F-U04-10	AS4301F-U04-10	AS4311F-U04-10
Ø 12	1/4	AS3201F-U02-12	AS3211F-U02-12	AS3301F-U02-12	AS3311F-U02-12
	3/8	AS3201F-U03-12	AS3211F-U03-12	AS3301F-U03-12	AS3311F-U03-12
	1/2	AS4201F-U04-12	AS4211F-U04-12	AS4301F-U04-12	AS4311F-U04-12
Ø 16	1/2	AS4201F-U04-16	AS4211F-U04-16	AS4301F-U04-16	AS4311F-U04-16

Note) For dimensions and other details refer to specific catalogue of the series at www.smc.eu

- AS
- AS-FS
- AS-1F
- AS·P
- AS·F
- AS-W2D
- AS-X737
- AS-2F
- AS-1F-3
- AS-DPP
- ASD
- Uni-AS
- Uni-AS-FS
- Uni-AS-1F
- AS-FE
- AS-FG
- AS-FSG
- AS-1FG
- ASD-FG
- ASG
- AS-FPQ/FPG
- AS·FM
- ASD·FM
- AS-F-D
- ASD-F-D
- AS-F-T
- ASD-F-T
- ASP
- ASV
- AS-R
- AS-Q
- Related

Speed Controller with Indicator/Uni Thread Type

AS-FS Series

Push-lock type

Elbow Type

■ Applicable tubing O.D. : Metric Size ■ Connection thread : Uni

How to Order

AS 2 2 0 1 FS [] - U01 - 06

Body size

2	1/8, 1/4
3	3/8
4	1/2

Type

2	Elbow
---	-------



Control type Note)

0	Meter-out
1	Meter-in

Note) Meter-out and meter-in types can be visually identified by colour of the knob.
Meter-out: Grey
Meter-in: Light blue

With indicator

Indicator direction

—	0°	
1	180°	

Note) Orientation of indicator direction is fixed when manufacturing, and cannot be changed by the user.

Applicable tubing O.D. Note 1)

Metric size

Tubing O.D.	
23	Ø 3.2 <small>Note 2)</small>
04	Ø 4
06	Ø 6
08	Ø 8
10	Ø 10
12	Ø 12
16	Ø 16

Note 1) For selecting applicable tubing O.D., refer to "Model" on the table below.
Note 2) Use Ø 1/8" tube.

Port size

U01	Uni 1/8
U02	Uni 1/4
U03	Uni 3/8
U04	Uni 1/2



Model

Port size	Applicable tubing O.D.							Elbow type	
	Metric size							Meter-out	Meter-in
	3.2	4	6	8	10	12	16		
R 1/8	●	●	●	●	●			AS2201FS-U01	AS2211FS-U01
R 1/4	●	●	●	●	●			AS2201FS-U02	AS2211FS-U02
R 1/4			●	●	●	●		AS3201FS-U02	AS3211FS-U02
R 3/8			●	●	●	●		AS3201FS-U03	AS3211FS-U03
R 1/2					●	●	●	AS4201FS-U04	AS4211FS-U04

Specifications

Fluid	Air
Proof pressure	1.5 MPa
Max. operating pressure	1 MPa
Min. operating pressure	0.1 MPa
Ambient and fluid temperature	-5 to 60 °C (No freezing)
Applicable tubing material	Nylon, Soft nylon, Polyurethane <small>Note)</small>

Note) Use caution at the max. operating pressure when using soft nylon or polyurethane tubing.
(Refer to the **WEB catalogue** at www.smc.eu for details.)

Refer to the **WEB catalogue** at www.smc.eu for inch size.

Elbow Type

AS-FS

Symbol

Flow Direction Symbols on Body

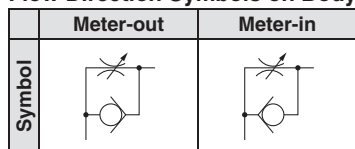

Applicable tubing O.D. [mm]	Uni thread	Model	
		Elbow type	
		Meter-out	Meter-in
Ø 3.2	R 1/8	AS2201FS-U01-23	AS2211FS-U01-23
	R 1/4	AS2201FS-U02-23	AS2211FS-U02-23
Ø 4	R 1/8	AS2201FS-U01-04	AS2211FS-U01-04
	R 1/4	AS2201FS-U02-04	AS2211FS-U02-04
Ø 6	R 1/8	AS2201FS-U01-06	AS2211FS-U01-06
	R 1/4	AS2201FS-U02-06	AS2211FS-U02-06
		AS3201FS-U02-06	AS3211FS-U02-06
Ø 8	R 3/8	AS3201FS-U03-06	AS3211FS-U03-06
	R 1/8	AS2201FS-U01-08	AS2211FS-U01-08
		AS2201FS-U02-08	AS2211FS-U02-08
Ø 10	R 1/4	AS3201FS-U02-08	AS3211FS-U02-08
	R 3/8	AS3201FS-U03-08	AS3211FS-U03-08
		AS2201FS-U01-10	AS2211FS-U01-10
Ø 12	R 1/4	AS2201FS-U02-10	AS2211FS-U02-10
	R 1/4	AS3201FS-U02-10	AS3211FS-U02-10
		AS3201FS-U03-10	AS3211FS-U03-10
	R 1/2	AS4201FS-U04-10	AS4211FS-U04-10
Ø 16	R 1/4	AS3201FS-U02-12	AS3211FS-U02-12
	R 3/8	AS3201FS-U03-12	AS3211FS-U03-12
	R 1/2	AS4201FS-U04-12	AS4211FS-U04-12
Ø 16	R 1/2	AS4201FS-U04-16	AS4211FS-U04-16

Note) For dimensions and other details refer to specific catalogue of the series at www.smc.eu

AS

AS-FS

AS·1F

AS·P

AS·F

AS·W2D

AS·X737

AS·2F

AS·1F·3

AS·DPP

ASD

Uni-AS

Uni-AS·FS

Uni-AS·1F

AS·FE

AS·FG

AS·FSG

AS·1FG

ASD·FG

ASG

AS·FPQ/
FPG

AS·FM

ASD·FM

AS·F·D

ASD·F·D

AS·F·T

ASD·F·T

ASP

ASV

AS·R
AS·Q

Related

Speed Controller with Uni One-touch Fitting

AS□□□1F-U Series

Elbow Type/Universal Type

■Applicable tubing O.D. : Metric Size ■Connection thread : Uni

How to Order

AS 2 2 1 1 F - U02 - 06 □ - □ - □

Body size

2	1/8, 1/4 standard
3	3/8 standard
4	1/2 standard

Type

2	Elbow
3	Universal

Control type

0	Meter-out
1	Meter-in

With One-touch fitting

Port size

U01	Uni 1/8
U02	Uni 1/4
U03	Uni 3/8
U04	Uni 1/2

Lock nut option

—	Hexagon lock nut
J	Round lock nut

Made to Order

X260	Antistatic type
------	-----------------

Refer to next page for details.

Option

—	None
N	Nickel plated

Applicable tubing O.D.

Metric size

23	∅ 3.2*
04	∅ 4
06	∅ 6
08	∅ 8
10	∅ 10
12	∅ 12

* Use ∅ 1/8" tube.



Model

Models marked with "●" are nickel plated as standard.

Connection thread Uni thread	Applicable tubing O.D.						Elbow type		Universal type	
	Metric size						Meter-out	Meter-in	Meter-out	Meter-in
	3.2	4	6	8	10	12				
1/8	●	●	●	●	Note 1)		AS2201F-U01	AS2211F-U01	AS2301F-U01	AS2311F-U01
1/4		●	●	●	●		AS2201F-U02	AS2211F-U02	AS2301F-U02	AS2311F-U02
1/4			●	●	●	●	AS3201F-U02	AS3211F-U02	AS3301F-U02	AS3311F-U02
3/8			●	●	●	●	AS3201F-U03	AS3211F-U03	AS3301F-U03	AS3311F-U03
1/2					●	●	AS4201F-U04	AS4211F-U04	AS4301F-U04	AS4311F-U04

Note 1) Elbow type only
 Note 2) Meter-out and meter-in types can be visually differentiated by the lock nut. The lock nut on the meter-out type is zinc chromated (the round lock nut is electroless nickel plated), while the meter-in type is black zinc chromate plated.

Specifications

Fluid	Air
Max. operating pressure	1 MPa
Min. operating pressure	0.1 MPa
Proof pressure	1.5 MPa
Ambient and fluid temperature	-5 to 60 °C (No freezing)
Applicable tubing material ^{Note 1)}	Nylon, Soft nylon, Polyurethane
Mounting thread	Uni thread
Thread seal	Gasket
Option	Round lock nut, Electroless nickel plated ^{Note 2)}

Note 1) Use caution at the max. operating pressure when using soft nylon or polyurethane tubing. (For details, refer to the WEB catalogue at www.smc.eu)
 Note 2) Brass parts are all electroless nickel plated.

For inch size, refer to the WEB catalogue at www.smc.eu



Elbow Type/Universal Type

AS□□□1F-U

Symbol

Flow Direction Symbols on Body

	Meter-out	Meter-in
Symbol		



Applicable tubing O.D. [mm]	Uni thread	Model			
		Elbow type		Universal type	
		Meter-out	Meter-in	Meter-out	Meter-in
Ø 3.2	1/8	AS2201F-U01-23	AS2211F-U01-23	AS2301F-U01-23	AS2311F-U01-23
	1/4	AS2201F-U01-04	AS2211F-U01-04	AS2301F-U01-04	AS2311F-U01-04
Ø 4	1/8	AS2201F-U02-04	AS2211F-U02-04	AS2301F-U02-04	AS2311F-U02-04
	1/4	AS2201F-U02-06	AS2211F-U02-06	AS2301F-U02-06	AS2311F-U02-06
Ø 6	1/8	AS2201F-U01-06	AS2211F-U01-06	AS2301F-U01-06	AS2311F-U01-06
	1/4	AS2201F-U02-06	AS2211F-U02-06	AS2301F-U02-06	AS2311F-U02-06
		AS3201F-U02-06	AS3211F-U02-06	AS3301F-U02-06	AS3311F-U02-06
Ø 8	3/8	AS3201F-U03-06	AS3211F-U03-06	AS3301F-U03-06	AS3311F-U03-06
	1/8	AS2201F-U01-08	AS2211F-U01-08	AS2301F-U01-08	AS2311F-U01-08
		AS2201F-U02-08	AS2211F-U02-08	AS2301F-U02-08	AS2311F-U02-08
Ø 10	1/4	AS3201F-U02-08	AS3211F-U02-08	AS3301F-U02-08	AS3311F-U02-08
	3/8	AS3201F-U03-08	AS3211F-U03-08	AS3301F-U03-08	AS3311F-U03-08
		AS2201F-U01-10	AS2211F-U01-10	—	—
Ø 12	1/4	AS2201F-U02-10	AS2211F-U02-10	AS2301F-U02-10	AS2311F-U02-10
	3/8	AS3201F-U02-10	AS3211F-U02-10	AS3301F-U02-10	AS3311F-U02-10
		AS3201F-U03-10	AS3211F-U03-10	AS3301F-U03-10	AS3311F-U03-10
Ø 12	1/2	AS4201F-U04-10	AS4211F-U04-10	AS4301F-U04-10	AS4311F-U04-10
	1/4	AS3201F-U02-12	AS3211F-U02-12	AS3301F-U02-12	AS3311F-U02-12
		AS3201F-U03-12	AS3211F-U03-12	AS3301F-U03-12	AS3311F-U03-12
Ø 12	3/8	AS3201F-U03-12	AS3211F-U03-12	AS3301F-U03-12	AS3311F-U03-12
	1/2	AS4201F-U04-12	AS4211F-U04-12	AS4301F-U04-12	AS4311F-U04-12

Note) For dimensions and other details refer to specific catalogue of the series at www.smc.eu



Made to Order

1 Antistatic type

X260

Model

Model	Applicable tubing O.D.			
	Metric size			
	4	6	8	10
AS22□1F-U01	●	●	●	●
AS22□1F-U02	●	●	●	●
AS32□1F-U03		●	●	

Note) Electroless nickel plated



How to Order

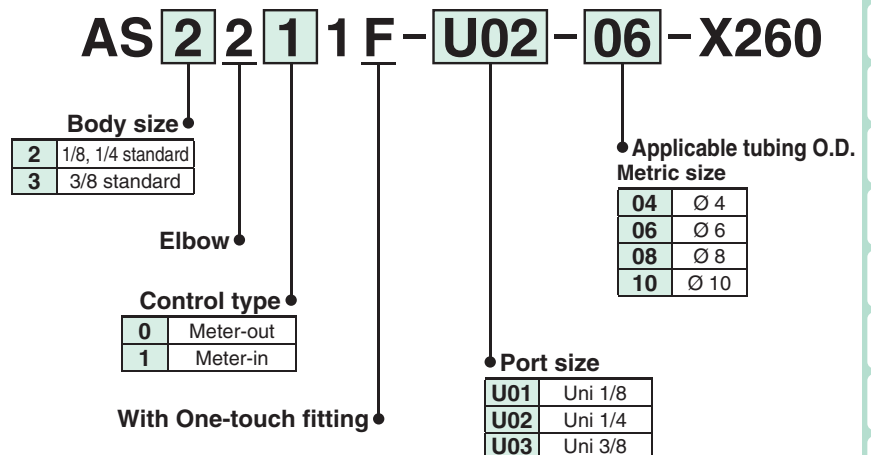

- AS
- AS-FS
- AS-1F
- AS·P
- AS·F
- AS-W2D
- AS-X737
- AS-2F
- AS-1F-3
- AS-DPP
- ASD
- Uni-AS
- Uni-AS-FS
- Uni-AS-1F
- AS-FE
- AS-FG
- AS-FSG
- AS-1FG
- ASD-FG
- ASG
- AS-FPQ/FPG
- AS-FM
- ASD-FM
- AS-F-D
- ASD-F-D
- AS-F-T
- ASD-F-T
- ASP
- ASV
- AS-R
- AS-Q
- Related

Speed Controller with Residual Pressure Release Valve

AS□□□1FE Series

Elbow Type/Universal Type

■ Applicable tubing O.D. : Metric Size ■ Connection thread : R

Residual Pressure Exhaust

How to Order

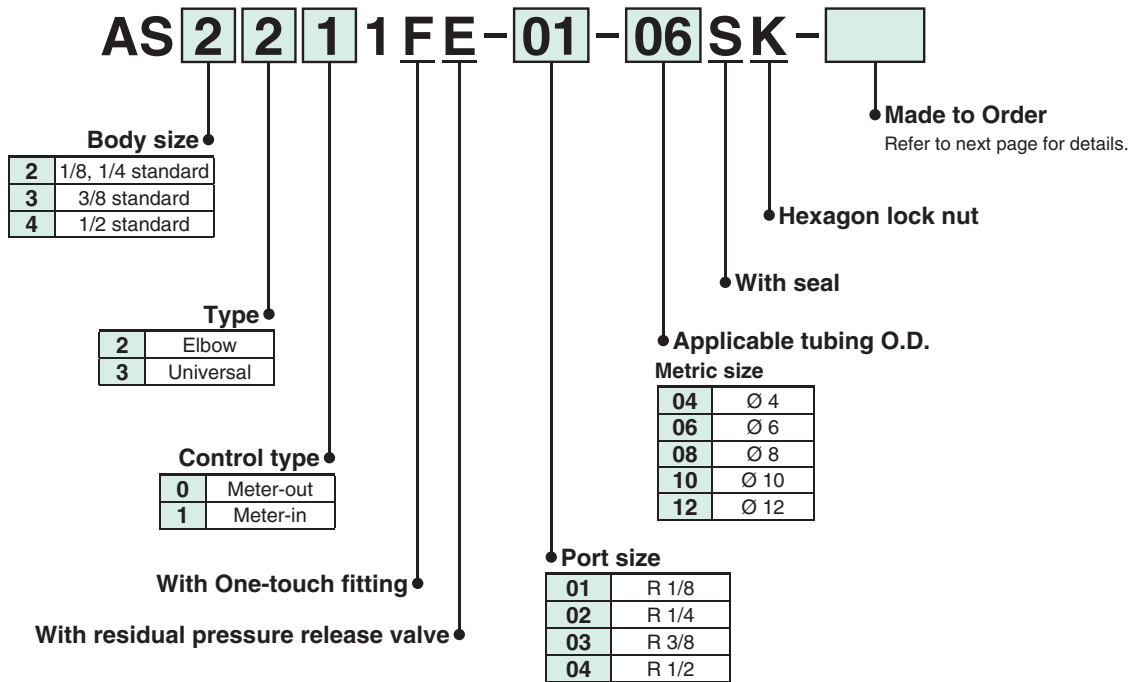

Residual pressure exhaust of the cylinder
Residual pressure can be easily released with one push of button.

Elbow type



Universal type



Model

Port size	Applicable tubing O.D.				Elbow type		Universal type		
	Metric size				Meter-out	Meter-in	Meter-out	Meter-in	
	4	6	8	10					12
R 1/8	●	●	●	Note 1)	AS2201FE-01	AS2211FE-01	AS2301FE-01	AS2311FE-01	
R 1/4	●	●	●	●	AS2201FE-02	AS2211FE-02	AS2301FE-02	AS2311FE-02	
R 3/8	●	●	●	●	AS3201FE-03	AS3211FE-03	AS3301FE-03	AS3311FE-03	
R 1/2				●	●	AS4201FE-04	AS4211FE-04	AS4301FE-04	AS4311FE-04

Note 1) Elbow type only

Note 2) Meter-out and meter-in types can be visually differentiated by the lock nut.

The lock nut on the meter-out type is electroless nickel plated, while the meter-in type is black zinc chromate plated.

Specifications

Fluid	Air
Proof pressure	1.5 MPa
Max. operating pressure	1 MPa
Min. operating pressure	0.1 MPa
Ambient and fluid temperature	-5 to 60 °C (No freezing)
Effective area of residual pressure release valve	0.8 mm ²
Applicable tubing material	Nylon, Soft nylon, Polyurethane

Elbow Type/Universal Type

AS□□□1FE

Symbol

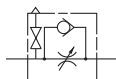

Applicable tubing O.D. [mm]	Uni thread	Model			
		Elbow type		Universal type	
		Meter-out	Meter-in	Meter-out	Meter-in
Ø 4	R 1/8	AS2201FE-01-04SK	AS2211FE-01-04SK	AS2301FE-01-04SK	AS2311FE-01-04SK
	R 1/4	AS2201FE-02-04SK	AS2211FE-02-04SK	AS2301FE-02-04SK	AS2311FE-02-04SK
Ø 6	R 1/8	AS2201FE-01-06SK	AS2211FE-01-06SK	AS2301FE-01-06SK	AS2311FE-01-06SK
	R 1/4	AS2201FE-02-06SK	AS2211FE-02-06SK	AS2301FE-02-06SK	AS2311FE-02-06SK
	R 3/8	AS3201FE-03-06SK	AS3211FE-03-06SK	AS3301FE-03-06SK	AS3311FE-03-06SK
Ø 8	R 1/8	AS2201FE-01-08SK	AS2211FE-01-08SK	AS2301FE-01-08SK	AS2311FE-01-08SK
	R 1/4	AS2201FE-02-08SK	AS2211FE-02-08SK	AS2301FE-02-08SK	AS2311FE-02-08SK
	R 3/8	AS3201FE-03-08SK	AS3211FE-03-08SK	AS3301FE-03-08SK	AS3311FE-03-08SK
Ø 10	R 1/8	AS2201FE-01-10SK	AS2211FE-01-10SK	—	—
	R 1/4	AS2201FE-02-10SK	AS2211FE-02-10SK	AS2301FE-02-10SK	AS2311FE-02-10SK
	R 3/8	AS3201FE-03-10SK	AS3211FE-03-10SK	AS3301FE-03-10SK	AS3311FE-03-10SK
	R 1/2	AS4201FE-04-10SK	AS4211FE-04-10SK	AS4301FE-04-10SK	AS4311FE-04-10SK
Ø 12	R 3/8	AS3201FE-03-12SK	AS3211FE-03-12SK	AS3301FE-03-12SK	AS3311FE-03-12SK
	R 1/2	AS4201FE-04-12SK	AS4211FE-04-12SK	AS4301FE-04-12SK	AS4311FE-04-12SK

Note) For dimensions and other details refer to specific catalogue of the series at www.smc.eu



Made to Order

1 Lubricant: Vaseline

X12

Example) AS2201FE-01-04SK-X12

2 Grease-free (Seal: Fluorine-coated) + Restrictor (Without check valve)

X21

Example) AS2201FE-01-04SK-X21

Note 1) Not particle-free

Note 2) The restrictor is only compatible with the part number of the meter-out type.

3 Restrictor (Without check valve)

X214

Example) AS2201FE-01-04SK-X214

Note) The restrictor is only compatible with the part number of the meter-out type.

AS

AS-FS

AS-1F

AS·P

AS·F

AS-W2D

AS-X737

AS-2F

AS-1F-3

AS-DPP

ASD

Uni-AS

Uni-AS-FS

Uni-AS-1F

AS·FE

AS·FG

AS-FSG

AS-1FG

ASD-FG

ASG

AS-FPQ/
FPG

AS·FM

ASD-FM

AS·F-D

ASD-F-D

AS·F-T

ASD-F-T

ASP

ASV

AS-R

AS-Q

Related

Stainless Steel: Speed Controller with One-touch Fitting RoHS

AS-FG Series

Push-lock type

Elbow Type/Universal Type

■ Applicable tubing O.D. : Metric Size ■ Connection thread : M, R

Corrosion Resistant

How to Order

Body size

1	M5 x 0.8
---	----------

Body size 1

Body size 2/3/4

2	1/8, 1/4
3	3/8
4	1/2

Control type Note 1)

0	Meter-out
1	Meter-in

Note 1) Meter-out and meter-in types can be visually identified by colour of the knob.
Meter-out: Grey
Meter-in: Light blue

Port size

M5	M5 x 0.8
----	----------

Stainless steel specifications (SUS303)

Note 1) The material can be visually identified by colour of the release button.
Stainless steel type: White

Port size

01	R 1/8
02	R 1/4
03	R 3/8
04	R 1/2

Applicable tubing O.D. Note 1)

Metric size

02	∅ 2
23	∅ 3.2 <small>Note 2)</small>
04	∅ 4
06	∅ 6

Note 1) For selecting applicable tubing O.D., refer to "Model" on the table below.
Note 2) Use ∅ 1/8" tube.

Applicable tubing O.D. Note 1)

Metric size

23	∅ 3.2 <small>Note 2)</small>	10	∅ 10
04	∅ 4	12	∅ 12
06	∅ 6	16	∅ 16
08	∅ 8		

Note 1) For selecting applicable tubing O.D., refer to "Model" on the table below.
Note 2) Use ∅ 1/8" tube.

Model

AS 1 2 0 1 FG - M5 - 06 A - []

AS 2 2 0 1 FG - 01 - 06 S A - []

Made to Order
Refer to next page for details.

Push-lock type

Seal method

—	Without sealant
S	With sealant

Elbow type

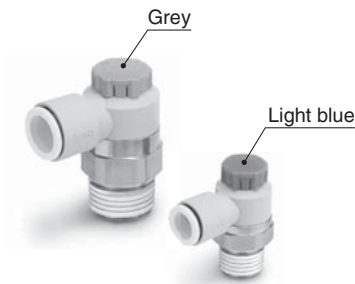

Universal type



Model

Port size	Applicable tubing O.D.							Elbow type		Universal type	
	Metric size							Meter-out	Meter-in	Meter-out	Meter-in
	2 <small>Note 2)</small>	3.2	4	6	8	10	12				
M5 x 0.8	<small>Note 1)</small>	●	●	●	●	●	●	AS1201FG-M5	AS1211FG-M5	AS1301FG-M5	AS1311FG-M5
R 1/8		●	●	●	●	●		AS2201FG-01	AS2211FG-01	AS2301FG-01	AS2311FG-01
R 1/4		●	●	●	●	●		AS2201FG-02	AS2211FG-02	AS2301FG-02	AS2311FG-02
R 1/4			●	●	●	●		AS3201FG-02	AS3211FG-02	AS3301FG-02	AS3311FG-02
R 3/8			●	●	●	●		AS3201FG-03	AS3211FG-03	AS3301FG-03	AS3311FG-03
R 1/2					●	●	<small>Note 1)</small>	AS4201FG-04	AS4211FG-04	AS4301FG-04	AS4311FG-04

Note 1) Universal type is not available.

Note 2) Only polyurethane tubing is applicable for ∅ 2.

Specifications

Fluid	Air
Proof pressure	1.5 MPa
Max. operating pressure	1 MPa
Min. operating pressure	0.1 MPa
Ambient and fluid temperature	-5 to 60 °C (No freezing)
Applicable tubing material	Nylon, Soft nylon, Polyurethane <small>Note 1)</small> , FEP, PFA

Note 1) Use caution at the max. operating pressure when using soft nylon or polyurethane tubing.
(For details, refer to the WEB catalogue at www.smc.eu)

Elbow Type/Universal Type

AS-FG

Symbol
Flow Direction Symbols on Body

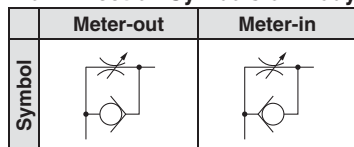

Applicable tubing O.D. [mm]	Connection thread	Model			
		Elbow type		Universal type	
		Meter-out	Meter-in	Meter-out	Meter-in
Ø 2	M5 x 0.8	AS1201FG-M5-02	AS1211FG-M5-02	—	—
Ø 3.2	M5 x 0.8	AS1201FG-M5-23	AS1211FG-M5-23	AS1301FG-M5-23	AS1311FG-M5-23
	R 1/8	AS2201FG-01-23	AS2211FG-01-23	AS2301FG-01-23	AS2311FG-01-23
Ø 4	M5 x 0.8	AS1201FG-M5-04	AS1211FG-M5-04	AS1301FG-M5-04	AS1311FG-M5-04
	R 1/8	AS2201FG-01-04S	AS2211FG-01-04S	AS2301FG-01-04S	AS2311FG-01-04S
	R 1/4	AS2201FG-02-04S	AS2211FG-02-04S	AS2301FG-02-04S	AS2311FG-02-04S
Ø 6	M5 x 0.8	AS1201FG-M5-06	AS1211FG-M5-06	AS1301FG-M5-06	AS1311FG-M5-06
	R 1/8	AS2201FG-01-06S	AS2211FG-01-06S	AS2301FG-01-06S	AS2311FG-01-06S
	R 1/4	AS2201FG-02-06S	AS2211FG-02-06S	AS2301FG-02-06S	AS2311FG-02-06S
		AS3201FG-02-06S	AS3211FG-02-06S	AS3301FG-02-06S	AS3311FG-02-06S
R 3/8	AS3201FG-03-06S	AS3211FG-03-06S	AS3301FG-03-06S	AS3311FG-03-06S	
Ø 8	R 1/8	AS2201FG-01-08S	AS2211FG-01-08S	AS2301FG-01-08S	AS2311FG-01-08S
	R 1/4	AS2201FG-02-08S	AS2211FG-02-08S	AS2301FG-02-08S	AS2311FG-02-08S
		AS3201FG-02-08S	AS3211FG-02-08S	AS3301FG-02-08S	AS3311FG-02-08S
R 3/8	AS3201FG-03-08S	AS3211FG-03-08S	AS3301FG-03-08S	AS3311FG-03-08S	
Ø 10	R 1/8	AS2201FG-01-10S	AS2211FG-01-10S	—	—
	R 1/4	AS2201FG-02-10S	AS2211FG-02-10S	AS2301FG-02-10S	AS2311FG-02-10S
		AS3201FG-02-10S	AS3211FG-02-10S	AS3301FG-02-10S	AS3311FG-02-10S
	R 3/8	AS3201FG-03-10S	AS3211FG-03-10S	AS3301FG-03-10S	AS3311FG-03-10S
	R 1/2	AS4201FG-04-10S	AS4211FG-04-10S	AS4301FG-04-10S	AS4311FG-04-10S
Ø 12	R 1/4	AS3201FG-02-12S	AS3211FG-02-12S	AS3301FG-02-12S	AS3311FG-02-12S
	R 3/8	AS3201FG-03-12S	AS3211FG-03-12S	AS3301FG-03-12S	AS3311FG-03-12S
	R 1/2	AS4201FG-04-12S	AS4211FG-04-12S	AS4301FG-04-12S	AS4311FG-04-12S
Ø 16	R 1/2	AS4201FG-04-16S	AS4211FG-04-16S	AS4301FG-04-16S	AS4311FG-04-16S

Refer to the WEB catalogue at www.smc.eu for inch size.

Note) For dimensions and other details refer to specific catalogue of the series at www.smc.eu



Made to Order

1 Lubricant: Vaseline **-X12**

Example) AS2201FG-01-04SA-X12

2 Grease-free (Seal: Fluorine-coated) + Restrictor (Without check valve) **-X21**

Example) AS2201FG-01-04SA-X21

Note 1) Not particle-free
Note 2) The restrictor is only compatible with the part number of the meter-out type.

3 Restrictor (Without check valve) **-X214**

Example) AS2201FG-01-04SA-X214

Note) The restrictor is only compatible with the part number of the meter-out type.

4 Clean Series **10-**

Example) 10-AS2201FG-01-04SA

Note 1) Fluorine grease is used.
Note 2) The particulate generation class is 5.
Note 3) Excluding G thread type.

- AS
- AS-FS
- AS-1F
- AS-P
- AS-F
- AS-W2D
- AS-X737
- AS-2F
- AS-1F-3
- AS-DPP
- ASD
- Uni-AS
- Uni-AS-FS
- Uni-AS-1F
- AS-FE
- AS-FG
- AS-FSG
- AS-1FG
- ASD-FG
- ASG
- AS-FPQ/FPG
- AS-FM
- ASD-FM
- AS-F-D
- ASD-F-D
- AS-F-T
- ASD-F-T
- ASP
- ASV
- AS-R
- AS-Q
- Related

Stainless Steel: Speed Controller with Indicator RoHS

AS-FSG Series

Push-lock type

Elbow / Universal Type

■ Applicable tubing O.D. : Metric Size ■ Connection thread : M5, R, G



Corrosion Resistant

How to Order

Body size

1	M5 x 0.8
---	----------

Port size

M5	M5 x 0.8
----	----------

Applicable tubing O.D. ^{Note 1)}

Metric size

02	Ø 2	04	Ø 4
23	Ø 3.2 ^{Note 2)}	06	Ø 6

Note 1) For selecting applicable tubing O.D., refer to "Model".
The material can be visually identified by colour of the release button. Stainless steel type: White
Note 2) Use Ø 1/8" tube.

Body size 1 AS 1 2 0 1 F S G [] - M5 - 06 - []

Body size 2/3/4 AS 2 2 0 1 F S G [] - [] 01 - 06 S - []

Body size

2	1/8, 1/4
3	3/8
4	1/2

Type

2	Elbow
3	Universal

With indicator
Stainless steel type

Control type ^{Note)}

0	Meter-out
1	Meter-in

Note) Meter-out and meter-in types can be visually identified by colour of the knob.
Meter-out: Grey
Meter-in: Light blue

Thread type

-	R
G	G

Indicator window direction

		Elbow	Universal
-	0°	●	-
1	180°	●	●
2	90°	●	-
3	270°	●	-

Made to Order
Refer to next page for details.

Seal method

-	Without sealant
S	With sealant

Applicable tubing O.D. ^{Note 1)}

Metric size

23	Ø 3.2 ^{Note 2)}	10	Ø 10
04	Ø 4	12	Ø 12
06	Ø 6	16	Ø 16
08	Ø 8		

Note 1) For selecting applicable tubing O.D., refer to "Model".
Note 2) Use Ø 1/8" tube.

Port size

01	R 1/8
02	R 1/4
03	R 3/8
04	R 1/2

Symbol Flow Direction Symbols on Body

	Meter-out	Meter-in
Symbol		

Specifications

Fluid	Air
Proof pressure	1.5 MPa
Max. operating pressure	1 MPa
Min. operating pressure	0.1 MPa
Ambient and fluid temperature	-5 to 60 °C (No freezing)
Applicable tubing material	Nylon, Soft nylon, Polyurethane ^{Note)} , FEP, PFA

Note 1) Use caution at the max. operating pressure when using soft nylon or polyurethane tubing.
(For details, refer to the WEB catalogue at www.smc.eu)



Elbow Type

AS-FSG

Model

Model	Port size	Applicable tubing O.D.						
		Metric size						
		2 <small>Note 1)</small>	3.2	4	6	8	10	12
AS1□□1FSG□-M5	M5 x 0.8	● <small>Note 2)</small>	●	●	●			
AS1□□1FSG□-U10/32	10-32UNF	● <small>Note 2)</small>	●	●	●			
AS2□□1FSG□-□01	R G	1/8	●	●	●	●	● <small>Note 2)</small>	
AS2□□1FSG□-□02		1/4	● <small>Note 2)</small>	●	●	●	●	
AS3□□1FSG□-□02		1/4			●	●	●	●
AS3□□1FSG□-□03		3/8			●	●	●	●
AS4□□1FSG□-□04		1/2					●	● <small>Note 2)</small>

Note 1) Only polyurethane tubing is applicable for Ø 2.

Note 2) Universal type is not available.



Applicable tubing O.D. [mm]	Connection thread	Model		Model	
		Elbow type		Universal type	
		Meter-out	Meter-in	Meter-out	Meter-in
Ø 2	M5 x 0.8	AS1201FSG-M5-02	AS1211FSG-M5-02	-	-
Ø 3.2	M5 x 0.8	AS1201FSG-M5-23	AS1211FSG-M5-23	AS1301FSG-M5-23	AS1311FSG-M5-23
	R 1/8	AS2201FSG-01-23S	AS2211FSG-01-23S	AS2301FSG-01-23S	AS2311FSG-01-23S
Ø 4	M5 x 0.8	AS1201FSG-M5-04	AS1211FSG-M5-04	AS1301FSG-M5-04	AS1311FSG-M5-04
	R 1/8	AS2201FSG-01-04S	AS2211FSG-01-04S	AS2301FSG-01-04S	AS2311FSG-01-04
	R 1/4	AS2201FSG-02-04S	AS2211FSG-02-04S	AS2301FSG-02-04S	AS2311FSG-02-04
Ø 6	M5 x 0.8	AS1201FSG-M5-06	AS1211FSG-M5-06	AS1301FSG-M5-06	AS1311FSG-M5-06
	R 1/8	AS2201FSG-01-06S	AS2211FSG-01-06S	AS2301FSG-01-06S	AS2311FSG-01-06
	R 1/4	AS2201FSG-02-06S	AS2211FSG-02-06S	AS2301FSG-02-06S	AS2311FSG-02-06
		AS3201FSG-02-06S	AS3211FSG-02-06S	AS3301FSG-02-06S	AS3311FSG-02-06
	R 3/8	AS3201FSG-03-06S	AS3211FSG-03-06S	AS3301FSG-03-06S	AS3311FSG-03-06
Ø 8	R 1/8	AS2201FSG-01-08S	AS2211FSG-01-08S	AS2301FSG-01-08S	AS2311FSG-01-08
	R 1/4	AS2201FSG-02-08S	AS2211FSG-02-08S	AS2301FSG-02-08S	AS2311FSG-02-08
		AS3201FSG-02-08S	AS3211FSG-02-08S	AS3301FSG-02-08S	AS3311FSG-02-08
	R 3/8	AS3201FSG-03-08S	AS3211FSG-03-08S	AS3301FSG-03-08S	AS3311FSG-03-08
	R 1/8	AS2201FSG-01-10S	AS2211FSG-01-10S	AS2301FSG-01-10S	AS2311FSG-01-10
Ø 10	R 1/4	AS2201FSG-02-10S	AS2211FSG-02-10S	-	-
		AS3201FSG-02-10S	AS3211FSG-02-10S	AS3301FSG-02-10S	AS3311FSG-02-10
	R 3/8	AS3201FSG-03-10S	AS3211FSG-03-10S	AS3301FSG-03-10S	AS3311FSG-03-10
	R 1/2	AS4201FSG-04-10S	AS4211FSG-04-10S	AS4301FSG-04-10S	AS4311FSG-04-10
Ø 12	R 1/4	AS3201FSG-02-12S	AS3211FSG-02-12S	AS3301FSG-02-12S	AS3311FSG-02-12
	R 3/8	AS3201FSG-03-12S	AS3211FSG-03-12S	AS3301FSG-03-12S	AS3311FSG-03-12
	R 1/2	AS4201FSG-04-12S	AS4211FSG-04-12S	AS4301FSG-04-12S	AS4311FSG-04-12
Ø 16	R 1/2	AS4201FSG-04-16S	AS4211FSG-04-16S	-	-

To order thread type "G", add a "G" and remove the final "S". Example: AS2201FSG-G02-04. Refer to the **WEB Catalogue** at www.smc.eu for inch size.

Note) For dimensions and other details refer to specific catalogue of the series at www.smc.eu



Made to Order

1 Lubricant: Vaseline -X12

Example) AS2201FSG-01-04S-X12

2 Grease-free (Seal: Fluorine-coated) + Restrictor (Without check valve) -X21

Example) AS2201FSG-01-04S-X21

Note 1) Not particle-free
 Note 2) The restrictor is only compatible with the part number of the meter-out type.
 Note 3) Only the needle and O-ring are fluorine-coated.

3 Restrictor (Without check valve) -X214

Example) AS2201FSG-01-04S-X214

Note) The restrictor is only compatible with the part number of the meter-out type.

4 Clean Series 10-

Example) 10-AS2201FSG-01-04S

Note 1) Fluorine grease is used.
 Note 2) The particulate generation class is 5.

- AS
- AS-FS
- AS-1F
- AS-P
- AS-F
- AS-W2D
- AS-X737
- AS-2F
- AS-1F-3
- AS-DPP
- ASD
- Uni-AS
- Uni-AS-FS
- Uni-AS-1F
- AS-FE
- AS-FG
- AS-FSG
- AS-1FG
- ASD-FG
- ASG
- AS-FPQ/FPG
- AS-FM
- ASD-FM
- AS-F-D
- ASD-F-D
- AS-F-T
- ASD-F-T
- ASP
- ASV
- AS-R
- AS-Q
- Related

Stainless Steel: Speed Controller with One-touch Fitting RoHS

AS□□□1FG Series

Elbow Type/Universal Type

■ Applicable tubing O.D. : Metric Size ■ Connection thread : M5, R

Corrosion Resistant

How to Order

AS 2 3 0 1 FG - 01 - 06 □ - □ - □

Body size

1	M5 standard
2	1/8, 1/4 standard
3	3/8 standard
4	1/2 standard

Type

2	Elbow
3	Universal

Control type

0	Meter-out
1	Meter-in

With One-touch fitting

Stainless steel specifications (SUS303)

Port size

M5	M5 x 0.8
01	R 1/8
02	R 1/4
03	R 3/8
04	R 1/2

Lock nut option

—	Hexagon lock nut
J	Round lock nut

Made to Order
Refer to next page for details.

Seal method

—	Without sealant
S	With seal*

* M5 is not available with seals.

Applicable tubing O.D. Metric size

23	∅ 3.2*
04	∅ 4
06	∅ 6
08	∅ 8
10	∅ 10
12	∅ 12

* Use ∅ 1/8" tube.

Stainless steel 303 used for metal parts.

Elbow type



Universal type



Model

Port size	Applicable tubing O.D.						Elbow type		Universal type	
	Metric size						Meter-out	Meter-in	Meter-out	Meter-in
	3.2	4	6	8	10	12				
M5 x 0.8	●	●	●				AS1201FG-M5	AS1211FG-M5	AS1301FG-M5	AS1311FG-M5
R 1/8	●	●	●	●	Note 2)		AS2201FG-01	AS2211FG-01	AS2301FG-01	AS2311FG-01
R 1/4		●	●	●	●		AS2201FG-02	AS2211FG-02	AS2301FG-02	AS2311FG-02
R 1/4			●	●	●	●	AS3201FG-02	AS3211FG-02	AS3301FG-02	AS3311FG-02
R 3/8			●	●	●	●	AS3201FG-03	AS3211FG-03	AS3301FG-03	AS3311FG-03
R 1/2					●	●	AS4201FG-04	AS4211FG-04	AS4301FG-04	AS4311FG-04

Note 1) Meter-out and meter-in types can be visually differentiated by the flow direction symbol on the resin body.

Note 2) Elbow type only

Specifications

Fluid	Air
Proof pressure	1.5 MPa
Max. operating pressure	1 MPa
Min. operating pressure	0.1 MPa
Ambient and fluid temperature	-5 to 60 °C (No freezing)
Applicable tubing material ^{Note)}	Nylon, Soft nylon, Polyurethane

Note) Use caution at the max. operating pressure when using soft nylon or polyurethane tubing.
(For details, refer to the **WEB catalogue** at www.smc.eu)

For inch size, refer to the **WEB catalogue** at www.smc.eu

Elbow Type/Universal Type

AS□□□1FG

Symbol

Flow Direction Symbols on Body

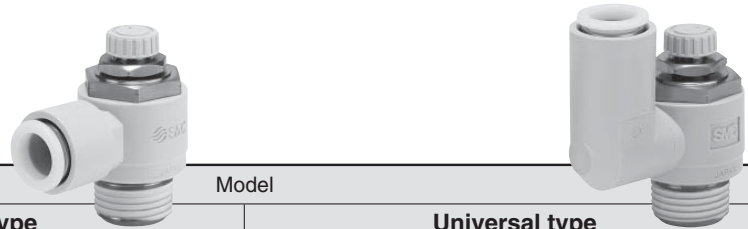
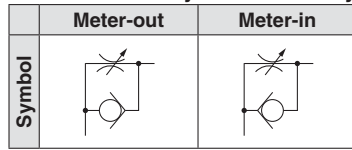

Applicable tubing O.D. [mm]	Uni thread	Model			
		Elbow type		Universal type	
		Meter-out	Meter-in	Meter-out	Meter-in
Ø 3.2	M5 x 0.8	AS1201FG-M5-23	AS1211FG-M5-23	AS1301FG-M5-23	AS1311FG-M5-23
	R 1/8	AS2201FG-01-23S	AS2211FG-01-23S	AS2301FG-01-23S	AS2311FG-01-23S
Ø 4	M5 x 0.8	AS1201FG-M5-04	AS1211FG-M5-04	AS1301FG-M5-04	AS1311FG-M5-04
	R 1/8	AS2201FG-01-04S	AS2211FG-01-04S	AS2301FG-01-04S	AS2311FG-01-04S
	R 1/4	AS2201FG-02-04S	AS2211FG-02-04S	AS2301FG-02-04S	AS2311FG-02-04S
Ø 6	M5 x 0.8	AS1201FG-M5-06	AS1211FG-M5-06	AS1301FG-M5-06	AS1311FG-M5-06
	R 1/8	AS2201FG-01-06S	AS2211FG-01-06S	AS2301FG-01-06S	AS2311FG-01-06S
	R 1/4	AS2201FG-02-06S	AS2211FG-02-06S	AS2301FG-02-06S	AS2311FG-02-06S
		AS3201FG-02-06S	AS3211FG-02-06S	AS3301FG-02-06S	AS3311FG-02-06S
R 3/8	AS3201FG-03-06S	AS3211FG-03-06S	AS3301FG-03-06S	AS3311FG-03-06S	
Ø 8	R 1/8	AS2201FG-01-08S	AS2211FG-01-08S	AS2301FG-01-08S	AS2311FG-01-08S
	R 1/4	AS2201FG-02-08S	AS2211FG-02-08S	AS2301FG-02-08S	AS2311FG-02-08S
		AS3201FG-02-08S	AS3211FG-02-08S	AS3301FG-02-08S	AS3311FG-02-08S
	R 3/8	AS3201FG-03-08S	AS3211FG-03-08S	AS3301FG-03-08S	AS3311FG-03-08S
Ø 10	R 1/8	AS2201FG-01-10S	AS2211FG-01-10S	—	—
	R 1/4	AS2201FG-02-10S	AS2211FG-02-10S	AS2301FG-02-10S	AS2311FG-02-10S
		AS3201FG-02-10S	AS3211FG-02-10S	AS3301FG-02-10S	AS3311FG-02-10S
	R 3/8	AS3201FG-03-10S	AS3211FG-03-10S	AS3301FG-03-10S	AS3311FG-03-10S
	R 1/2	AS4201FG-04-10S	AS4211FG-04-10S	AS4301FG-04-10S	AS4311FG-04-10S
Ø 12	R 1/4	AS3201FG-02-12S	AS3211FG-02-12S	AS3301FG-02-12S	AS3311FG-02-12S
	R 3/8	AS3201FG-03-12S	AS3211FG-03-12S	AS3301FG-03-12S	AS3311FG-03-12S
	R 1/2	AS4201FG-04-12S	AS4211FG-04-12S	AS4301FG-04-12S	AS4311FG-04-12S

Note) For dimensions and other details refer to specific catalogue of the series at www.smc.eu



Made to Order

1 Lubricant: Vaseline

X12

Example) AS1201FG-M5-23-X12

2 Grease-free (Seal: Fluorine-coated) + Restrictor (Without check valve)

X21

Example) AS1201FG-M5-23-X21

Note 1) Not particle-free

Note 2) The restrictor is only compatible with the part number of the meter-out type.

3 Restrictor (Without check valve)

X214

Example) AS1201FG-M5-23-X214

Note) The restrictor is only compatible with the part number of the meter-out type.

4 Clean Series

10-

Lubricant: Fluorine-based grease, Double package

Example) 10-AS1201FG-M5-23

- AS
- AS-FS
- AS-1F
- AS-P
- AS-F
- AS-W2D
- AS-X737
- AS-2F
- AS-1F-3
- AS-DPP
- ASD
- Uni-AS
- Uni-AS-FS
- Uni-AS-1F
- AS-FE
- AS-FG
- AS-FSG
- AS-1FG
- ASD-FG
- ASG
- AS-FPQ/FPG
- AS-FM
- ASD-FM
- AS-F-D
- ASD-F-D
- AS-F-T
- ASD-F-T
- ASP
- ASV
- AS-R
- AS-Q
- Related

Stainless steel: Speed Controller with one touch fittings RoHS

Push-lock type
AS-FG Series

In-line Type

■ Applicable tubing O.D. : Metric Size

How to Order



Flow Direction
Symbol on Body

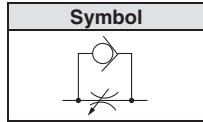

AS 200 2 FG - 06 A

Body size

100	M5 standard
200	1/8 standard
205	1/4 standard
300	3/8 standard
400	1/2 standard

With One-touch fittings

Stainless steel type
(Stainless steel 303)

Push-lock type

Applicable tubing O.D.

Metric size

23	Ø 3.2*1
04	Ø 4
06	Ø 6
08	Ø 8
10	Ø 10
12	Ø 12

*1: Use Ø 1/8" tubing.

Model

Model	Applicable tubing O.D.					
	Metric size					
	3.2	4	6	8	10	12
AS1002FG	●	●	●			
AS2002FG		●	●			
AS2052FG			●	●		
AS3002FG			●	●	●	●
AS4002FG					●	●

Specifications

Fluid	Air
Proof pressure	1.5 MPa
Max. operating pressure	1 MPa
Min. operating pressure	0.1 MPa
Ambient and fluid temperature	-5 to 60 °C (No freezing)
Applicable tubing material	Nylon, Soft nylon, Polyurethane*1, FEP, PFA

*1: Use caution at the max. operating pressure when using soft nylon or polyurethane tubing. (Refer to the catalogue at www.smc.eu for details.)

Applicable tubing O.D. [mm]	Model
Ø 3.2	AS1002FG-23A
Ø 4	AS1002FG-04A
	AS2002FG-04A
Ø 6	AS1002FG-06A
	AS2002FG-06A
	AS2052FG-06A
	AS3002FG-06A
Ø 8	AS2052FG-08A
	AS3002FG-08A
Ø 10	AS3002FG-10A
	AS4002FG-10A
Ø 12	AS3002FG-12A
	AS4002FG-12A

Stainless steel: Speed Controller with Indicator RoHS

AS-FSG Series

Push-lock type

In-line Type

■ Applicable tubing O.D. : Metric Size

How to Order



Flow Direction
Symbol on Body

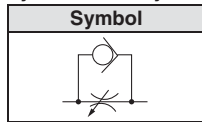

AS 200 2 F S G 1 - 06

Body size	
100	M5 standard
200	1/8 standard
205	1/4 standard
300	3/8 standard
400	1/2 standard

With One-touch fittings

With indicator

Stainless steel type
(Stainless steel 303)

Applicable tubing O.D.*1

Metric size	
23	∅ 3.2*1
04	∅ 4
06	∅ 6
08	∅ 8
10	∅ 10
12	∅ 12

*1: Use ∅ 1/8" tubing.

Indicator window direction

—	0°		2	90°	
1	180°		3	270°	

Model

Model	Applicable tubing O.D.					
	Metric size					
	3.2	4	6	8	10	12
AS1002FSG	●	●	●			
AS2002FSG		●	●			
AS2052FSG			●	●		
AS3002FSG			●	●	●	●
AS4002FSG					●	●

Specifications

Fluid	Air
Proof pressure	1.5 MPa
Max. operating pressure	1 MPa
Min. operating pressure	0.1 MPa
Ambient and fluid temperature	-5 to 60 °C (No freezing)
Applicable tubing material	Nylon, Soft nylon, Polyurethane*1, FEP, PFA

*1: Use caution at the max. operating pressure when using soft nylon or polyurethane tubing. (Refer to the catalogue at www.smc.eu for details.)

Applicable tubing O.D. [mm]	Model
∅ 3.2	AS1002FSG-23
∅ 4	AS1002FSG-04
	AS2002FSG-04
∅ 6	AS1002FSG-06
	AS2002FSG-06
	AS2052FSG-06
	AS3002FSG-06
∅ 8	AS2052FSG-08
	AS3002FSG-08
∅ 10	AS3002FSG-10
	AS4002FSG-10
∅ 12	AS3002FSG-12
	AS4002FSG-12

- AS
- AS-FS
- AS-1F
- AS-P
- AS-F
- AS-W2D
- AS-X737
- AS-2F
- AS-1F-3
- AS-DPP
- ASD
- Uni-AS
- Uni-AS-FS
- Uni-AS-1F
- AS-FE
- AS-FG
- AS-FSG
- AS-1FG
- ASD-FG
- ASG
- AS-FPQ/FPG
- AS-FM
- ASD-FM
- AS-F-D
- ASD-F-D
- AS-F-T
- ASD-F-T
- ASP
- ASV
- AS-R
- AS-Q
- Related

Stainless Steel: Speed Controller with One-touch Fitting

RoHS

AS□1FG Series

In-line Type

■ Applicable tubing O.D. : Metric Size

Corrosion Resistant

How to Order

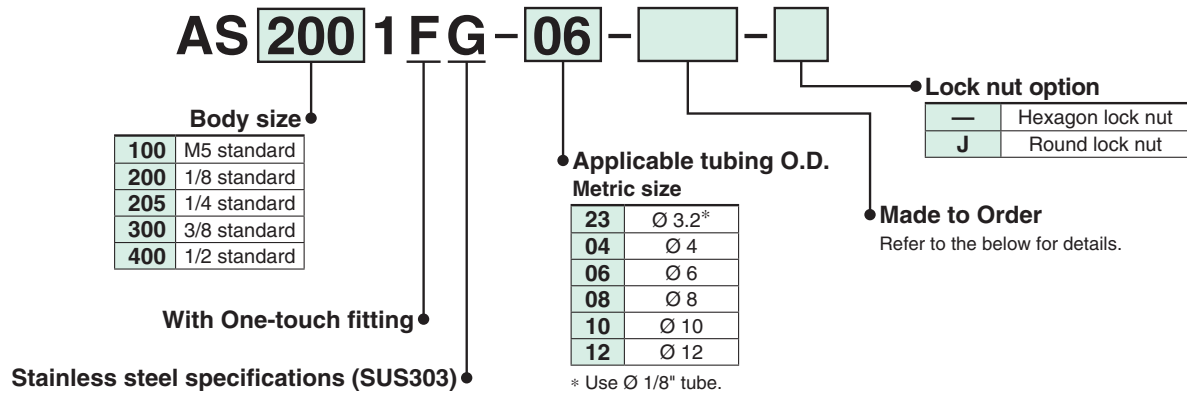

Model

Model	Applicable tubing O.D.					
	Metric size					
	3.2	4	6	8	10	12
AS1001FG	●	●	●			
AS2001FG		●	●			
AS2051FG			●	●		
AS3001FG			●	●	●	●
AS4001FG					●	●

Specifications

Fluid	Air
Proof pressure	1.5 MPa
Max. operating pressure	1 MPa
Min. operating pressure	0.1 MPa
Ambient and fluid temperature	-5 to 60°C (No freezing)
Applicable tubing material ^(Note)	Nylon, Soft nylon, Polyurethane

Note) Use caution at the max. operating pressure when using soft nylon or polyurethane tubing.
(For details, refer to the WEB catalogue at www.smc.eu)

In-line Type

AS□1FG

Stainless steel 303 used for metal parts.

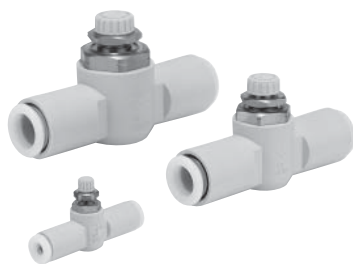

Symbol



Applicable tubing O.D. mm	Model	Applicable tubing O.D. mm	Model
	In-line type		In-line type
∅ 3.2	AS1001FG-23	∅ 8	AS2051FG-08
	AS1001FG-04		AS3001FG-08
	AS2001FG-04		AS3001FG-10
∅ 4	AS1001FG-06	∅ 10	AS4001FG-10
	AS2001FG-06		AS3001FG-12
	AS2051FG-06		AS4001FG-12
∅ 6	AS3001FG-06	∅ 12	

For inch size, refer to the WEB catalogue at www.smc.eu

Made to Order

Made to Order

1 Lubricant: Vaseline

X12

Example) AS1001FG-04-X12

2 Grease-free (Seal: Fluorine-coated) + Restrictor (Without check valve)

X21

Example) AS1001FG-04-X21

Note) Not particle-free

3 Restrictor (Without check valve)

X214

Example) AS1001FG-04-X214

4 Clean Series

10-

Lubricant: Fluorine-based grease Double package

Example) 10-AS1001FG-04

ASD□30FG Series

Universal Type

■ Applicable tubing O.D. : Metric Size ■ Connection thread : M5, R

How to Order

Corrosion Resistant

Lurch Prevention

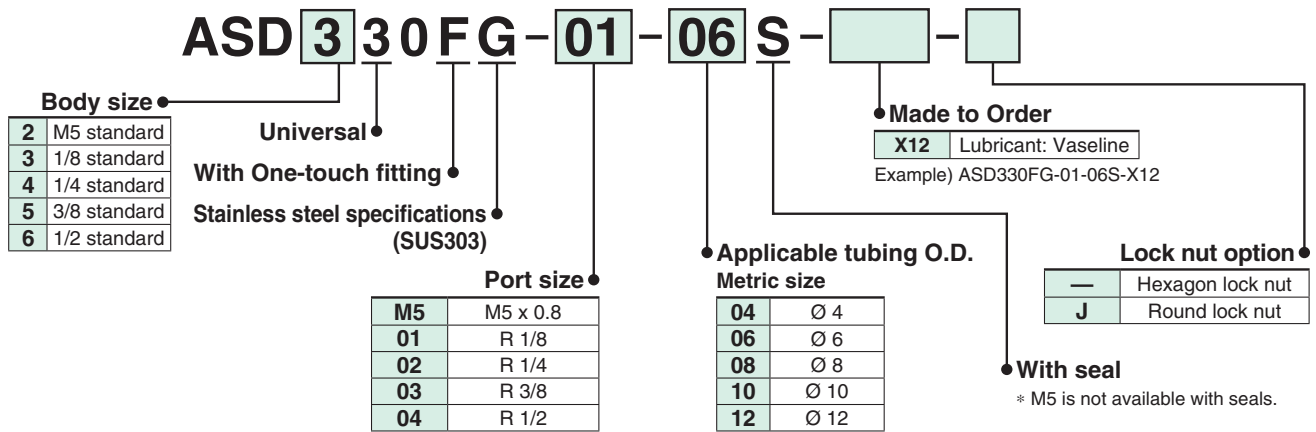

Model

Model	Port size	Applicable tubing O.D.				
		Metric size				
		4	6	8	10	12
ASD230FG-M5	M5 x 0.8	●	●			
ASD330FG-01	R 1/8		●	●		
ASD430FG-02	R 1/4		●	●	●	
ASD530FG-02	R 1/4		●	●	●	●
ASD530FG-03	R 3/8		●	●	●	●
ASD630FG-04	R 1/2				●	●

Specifications

Fluid	Air
Proof pressure	1.5 MPa
Max. operating pressure	1 MPa
Min. operating pressure	0.1 MPa
Ambient and fluid temperature	-5 to 60 °C (No freezing)
Applicable tubing material <small>(Note)</small>	Nylon, Soft nylon, Polyurethane

Note) Use caution at the max. operating pressure when using soft nylon or polyurethane tubing. (For details, refer to the **WEB catalogue** at www.smc.eu)

Universal Type

ASD□30FG

Stainless steel 303 used for metal parts. Prevention of stick-slip phenomenon, and speed control of a single acting cylinder.

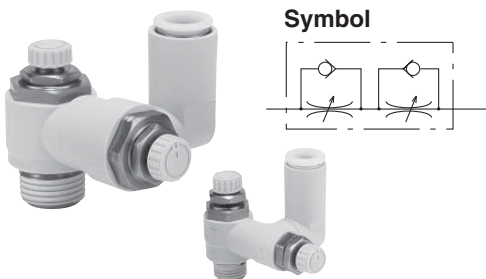

Applicable tubing O.D. [mm]	Connection thread	Model
		Universal type
Ø 4	M5 x 0.8	ASD230FG-M5-04
	M5 x 0.8	ASD230FG-M5-06
Ø 6	R 1/8	ASD330FG-01-06S
	R 1/4	ASD430FG-02-06S
	R 3/8	ASD530FG-02-06S
	R 3/8	ASD530FG-03-06S
Ø 8	R 1/8	ASD330FG-01-08S
	R 1/4	ASD430FG-02-08S
	R 3/8	ASD530FG-02-08S

Applicable tubing O.D. [mm]	Connection thread	Model
		Universal type
Ø 10	R 1/4	ASD430FG-02-10S
	R 3/8	ASD530FG-02-10S
	R 1/2	ASD630FG-04-10S
	R 1/4	ASD530FG-02-12S
Ø 12	R 3/8	ASD530FG-03-12S
	R 1/2	ASD630FG-04-12S

For inch size, refer to the **WEB catalogue** at www.smc.eu

Made to Order

Made to Order

1 Lubricant: Vaseline

X12

2 Clean Series

10-

Example) ASD230FG-M5-04-X12

Lubricant: Fluorine-based grease, Double package
Example) 10-ASD230FG-M5-04

- AS
- AS-FS
- AS-1F
- AS-P
- AS-F
- AS-W2D
- AS-X737
- AS-2F
- AS-1F-3
- AS-DPP
- ASD
- Uni-AS
- Uni-AS-FS
- Uni-AS-1F
- AS-FE
- AS-FG
- AS-FSG
- AS-1FG
- ASD-FG
- ASG
- AS-FPQ/FPG
- AS-FM
- ASD-FM
- AS-F-D
- ASD-F-D
- AS-F-T
- ASD-F-T
- ASP
- ASV
- AS-R
- AS-Q
- Related

Stainless Steel 316 Series Speed Controller

ASG Series

Elbow Type

■ Applicable tubing O.D. : Metric Size ■ Connection thread : M5, R

Corrosion Resistant

How to Order

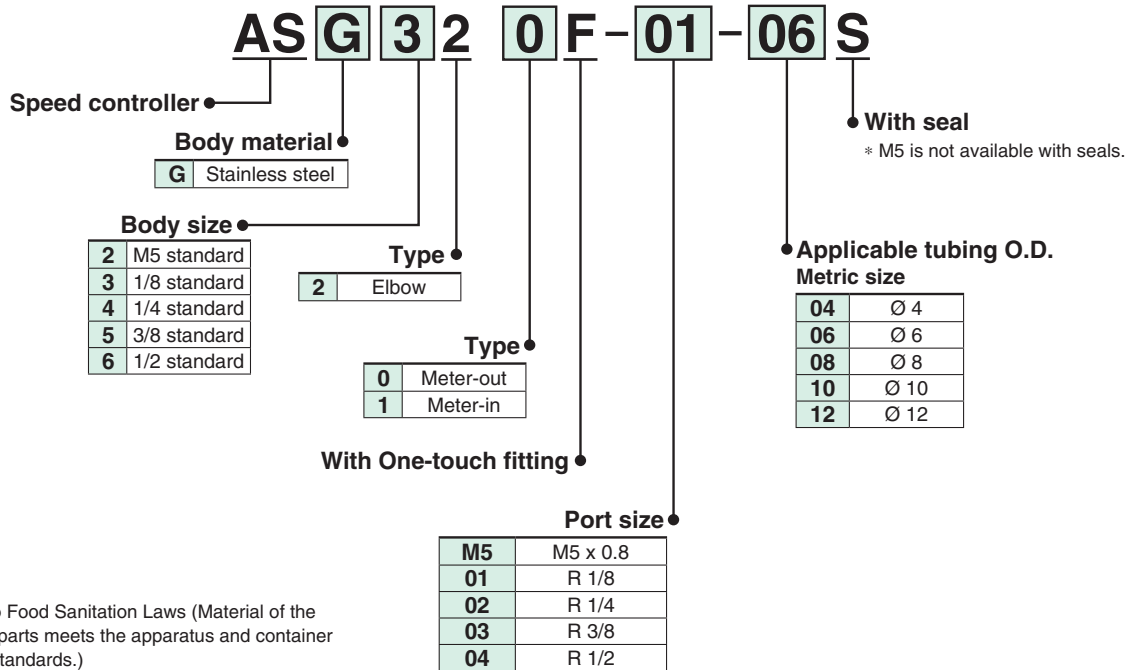

Conforms to Food Sanitation Laws (Material of the component parts meets the apparatus and container packaging standards.)

Material: Stainless steel 316

Sealant: Special FKM
Seat ring: Stainless steel 303

Applicable tubing materials

- FEP
- PFA
- Nylon
- Soft nylon
- Polyurethane
- Polyolefin

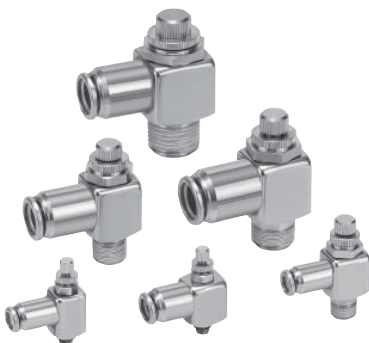

Model

Model	Port size	Applicable tubing O.D.					Applicable cylinder bore size [mm]
		Metric size					
		4	6	8	10	12	
ASG22□F-M5	M5 x 0.8	●	●				6, 10, 16, 20
ASG32□F-01	R 1/8	●	●	●			20, 25, 32
ASG42□F-02	R 1/4		●	●	●		20, 25, 32, 40
ASG52□F-03	R 3/8			●	●	●	40, 50, 63
ASG62□F-04	R 1/2					●	63, 80, 100

Specifications

Fluid	Air
Proof pressure	1.5 MPa
Max. operating pressure	1 MPa
Min. operating pressure	0.1 MPa
Ambient and fluid temperature	-5 to 60 °C (No freezing)
Number of needle rotations	10 turns (8 turns ^{Note 1)})
Applicable tubing material	FEP, PFA, Nylon, Soft nylon, Polyurethane ^{Note 3)} , Polyolefin

Note 1) In case of ASG22□F-M5

Note 2) Please be cautious of the max. operating pressure when soft nylon or polyurethane tubing is used.

Note 3) When polyurethane tubing is used, please use an inner sleeve.

Elbow Type

ASG

Symbol

Flow Direction Symbols on Body

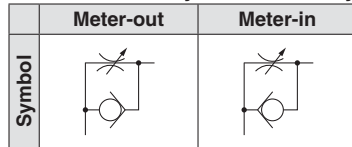

Applicable tubing O.D. [mm]	Connection thread	Model	
		Elbow type	
		Meter-out	Meter-in
Ø 4	M5 x 0.8	ASG220F-M5-04	ASG221F-M5-04
	R 1/8	ASG320F-01-04S	ASG321F-01-04S
Ø 6	M5 x 0.8	ASG220F-M5-06	ASG221F-M5-06
	R 1/8	ASG320F-01-06S	ASG321F-01-06S
	R 1/4	ASG420F-02-06S	ASG421F-02-06S
Ø 8	R 1/8	ASG320F-01-08S	ASG321F-01-08S
	R 1/4	ASG420F-02-08S	ASG421F-02-08S
	R 3/8	ASG520F-03-08S	ASG521F-03-08S
Ø 10	R 1/4	ASG420F-02-10S	ASG421F-02-10S
	R 3/8	ASG520F-03-10S	ASG521F-03-10S
Ø 12	R 3/8	ASG520F-03-12S	ASG521F-03-12S
	R 1/2	ASG620F-04-12S	ASG621F-04-12S

Note) For dimensions and other details refer to specific catalogue of the series at www.smc.eu

AS

AS-FS

AS-1F

AS-P

AS-F

AS-W2D

AS-X737

AS-2F

AS-1F-3

AS-DPP

ASD

Uni-AS

Uni-AS-FS

Uni-AS-1F

AS-FE

AS-FG

AS-FSG

AS-1FG

ASD-FG

ASG

AS-FPQ/
FPG

AS-FM

ASD-FM

AS-F-D

ASD-F-D

AS-F-T

ASD-F-T

ASP

ASV

AS-R

AS-Q

Related

Clean Speed Controller with One-touch Fitting RoHS

AS-FPQ/FPG Series

Elbow Type

■Applicable tubing O.D. : Metric Size ■Connection thread : M5, R

Clean

How to Order

AS 2 2 1 1 FP Q - 01 - 06 - □

Body size

1	M5 standard
2	1/8, 1/4 standard
3	3/8 standard
4	1/2 standard

Elbow

Control type

0	Meter-out
1	Meter-in

With One-touch fitting

Clean specifications

Metal parts material

Q	Brass (electroless nickel plated)
G	Stainless steel 304

•Lock nut option

—	Hexagon lock nut
J	Round lock nut

•Applicable tubing O.D. Metric size

04	∅ 4
06	∅ 6
08	∅ 8
10	∅ 10
12	∅ 12

•Port size

M5	M5 x 0.8
01	R 1/8
02	R 1/4
03	R 3/8
04	R 1/2

AS-FPQ/Brass (electroless nickel plated)
Release button colour: Light grey



AS-FPG/Stainless steel 304
Release button colour: Light blue



Model

Port size	Applicable tubing O.D.					Elbow type	
	Metric size					Meter-out	Meter-in
	4	6	8	10	12		
M5 x 0.8	●	●				AS1201FP□-M5	AS1211FP□-M5
R 1/8	●	●	●			AS2201FP□-01	AS2211FP□-01
R 1/4	●	●	●	●		AS2201FP□-02	AS2211FP□-02
R 3/8		●	●	●	●	AS3201FP□-03	AS3211FP□-03
R 1/2				●	●	AS4201FP□-04	AS4211FP□-04

Specifications

Fluid	Air
Cleanliness class (ISO class)	Class 3 ^{Note 1)}
Proof pressure (20 °C)	1.5 MPa ^{Note 2)}
Max. operating pressure (20 °C)	1 MPa ^{Note 3)}
Min. operating pressure	0.1 MPa
Ambient and fluid temperature	-5 to 60 °C (No freezing)
Oil	Fluorine-based grease

Note 1) Refer to particle generation classification.

Note 2) Proof pressure is 1.5 times higher than maximum operating pressure.

Note 3) The value of the maximum operating pressure is at a temperature of 20 °C.

In other cases, refer to "Relationship between Operating Temperature and Max. Operating Pressure" in the WEB catalogue at www.smc.eu

Particle generation classification

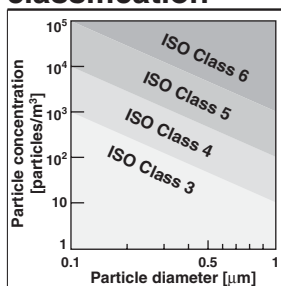

Note) Refer to the WEB catalogue at www.smc.eu for details.

Recommended Applicable Tubing

Tubing material	Clean series polyurethane tubing: Series 10-
Tubing O.D.	∅ 4, ∅ 6, ∅ 8, ∅ 10, ∅ 12

Polyurethane tubing: Series TU, Nylon tubing: Series T and Soft nylon tubing: Series TS can also be used. However, the degree of clean performance will decline.

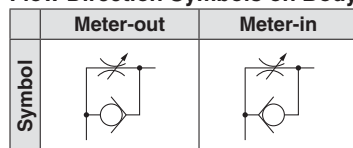
Elbow Type
AS-FPQ/FPG
Symbol
Flow Direction Symbols on Body

AS-FPQ/Brass (electroless nickel plated)

Applicable tubing O.D. [mm]	Uni thread	Model	
		Elbow type	
		Meter-out	Meter-in
Ø 4	M5 x 0.8	AS1201FPQ-M5-04	AS1211FPQ-M5-04
	R 1/8	AS2201FPQ-01-04	AS2211FPQ-01-04
	R 1/4	AS2201FPQ-02-04	AS2211FPQ-02-04
Ø 6	M5 x 0.8	AS1201FPQ-M5-06	AS1211FPQ-M5-06
	R 1/8	AS2201FPQ-01-06	AS2211FPQ-01-06
	R 1/4	AS2201FPQ-02-06	AS2211FPQ-02-06
	R 3/8	AS3201FPQ-03-06	AS3211FPQ-03-06
Ø 8	R 1/8	AS2201FPQ-01-08	AS2211FPQ-01-08
	R 1/4	AS2201FPQ-02-08	AS2211FPQ-02-08
	R 3/8	AS3201FPQ-03-08	AS3211FPQ-03-08
Ø 10	R 1/4	AS2201FPQ-02-10	AS2211FPQ-02-10
	R 3/8	AS3201FPQ-03-10	AS3211FPQ-03-10
	R 1/2	AS4201FPQ-04-10	AS4211FPQ-04-10
Ø 12	R 3/8	AS3201FPQ-03-12	AS3211FPQ-03-12
	R 1/2	AS4201FPQ-04-12	AS4211FPQ-04-12

AS-FPG/Stainless steel 304

Applicable tubing O.D. [mm]	Uni thread	Model	
		Elbow type	
		Meter-out	Meter-in
Ø 4	M5 x 0.8	AS1201FPG-M5-04	AS1211FPG-M5-04
	R 1/8	AS2201FPG-01-04	AS2211FPG-01-04
	R 1/4	AS2201FPG-02-04	AS2211FPG-02-04
Ø 6	M5 x 0.8	AS1201FPG-M5-06	AS1211FPG-M5-06
	R 1/8	AS2201FPG-01-06	AS2211FPG-01-06
	R 1/4	AS2201FPG-02-06	AS2211FPG-02-06
	R 3/8	AS3201FPG-03-06	AS3211FPG-03-06
Ø 8	R 1/8	AS2201FPG-01-08	AS2211FPG-01-08
	R 1/4	AS2201FPG-02-08	AS2211FPG-02-08
	R 3/8	AS3201FPG-03-08	AS3211FPG-03-08
Ø 10	R 1/4	AS2201FPG-02-10	AS2211FPG-02-10
	R 3/8	AS3201FPG-03-10	AS3211FPG-03-10
	R 1/2	AS4201FPG-04-10	AS4211FPG-04-10
Ø 12	R 3/8	AS3201FPG-03-12	AS3211FPG-03-12
	R 1/2	AS4201FPG-04-12	AS4211FPG-04-12

Note) For dimensions and other details refer to specific catalogue of the series at www.smc.eu

AS

AS-FS

AS-1F

AS-P

AS-F

AS-W2D

AS-X737

AS-2F

AS-1F-3

AS-DPP

ASD

Uni-AS

Uni-AS-FS

Uni-AS-1F

AS-FE

AS-FG

AS-FSG

AS-1FG

ASD-FG

ASG

AS-FPQ/
FPG

AS-FM

ASD-FM

AS-F-D

ASD-F-D

AS-F-T

ASD-F-T

ASP

ASV

AS-R

AS-Q

Related

Speed Controller for Low Speed Operation with One-touch Fitting RoHS

AS□□□/FM Series

Elbow Type/Universal Type

■ Applicable tubing O.D. : Metric Size ■ Connection thread : M5, R

Low Speed Control

How to Order

AS 2 2 0 1 FM - 01 - 06 □ - □ - □

Body size

1	M5 standard
2	1/8, 1/4 standard

Type

2	Elbow
3	Universal

Control type

0	Meter-out
1	Meter-in

With One-touch fitting

For low speed control

Port size

M5	M5 x 0.8
01	R 1/8
02	R 1/4

Lock nut option

—	Hexagon lock nut
J	Round lock nut

Made to Order
Refer to next page for details.

Seal method

—	Without sealant
S	With seal

* M5 is not available with seals.

Applicable tubing O.D.

Metric size

23	∅ 3.2*
04	∅ 4
06	∅ 6
08	∅ 8
10	∅ 10

* Use ∅ 1/8" tube.

Ideal for low speed control at 10 to 50 mm/sec

Elbow type



Universal type



Model

Port size	Applicable tubing O.D.					Elbow type		Universal type	
	Metric size					Meter-out	Meter-in	Meter-out	Meter-in
	3.2	4	6	8	10				
M5 x 0.8	●	●	●			AS1201FM-M5	AS1211FM-M5	AS1301FM-M5	AS1311FM-M5
R 1/8	●	●	●	●		AS2201FM-01	AS2211FM-01	AS2301FM-01	AS2311FM-01
R 1/4		●	●	●	●	AS2201FM-02	AS2211FM-02	AS2301FM-02	AS2311FM-02

Specifications

Fluid	Air
Proof pressure	1.5 MPa
Max. operating pressure	1 MPa
Min. operating pressure	0.1 MPa
Ambient and fluid temperature	-5 to 60 °C (No freezing)
Applicable tubing material ^{Note 1)}	Nylon, Soft nylon, Polyurethane
Option ^{Note 2)}	With seal

Note 1) Use caution at the max. operating pressure when using soft nylon or polyurethane tubing.

(For details, refer to the **WEB catalogue** at www.smc.eu)

Note 2) M5 type port is not available with seal.

Note 3) Brass parts are all electroless nickel plated. The lock nut of the meter-out type is zinc chromate plated (the round lock nut is electroless nickel plated), then, the knob of the M5 type and the lock nut of the meter-in type are black zinc chromate plated.

For inch size, refer to the **WEB catalogue** at www.smc.eu

Elbow Type/Universal Type

AS□□□1FM

Symbol

Flow Direction Symbols on Body

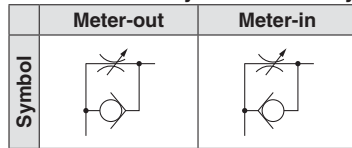

Applicable tubing O.D. [mm]	Uni thread	Model			
		Elbow type		Universal type	
		Meter-out	Meter-in	Meter-out	Meter-in
Ø 3.2	M5 x 0.8	AS1201FM-M5-23	AS1211FM-M5-23	AS1301FM-M5-23	AS1311FM-M5-23
	R 1/8	AS2201FM-01-23S	AS2211FM-01-23S	AS2301FM-01-23S	AS2311FM-01-23S
Ø 4	M5 x 0.8	AS1201FM-M5-04	AS1211FM-M5-04	AS1301FM-M5-04	AS1311FM-M5-04
	R 1/8	AS2201FM-01-04S	AS2211FM-01-04S	AS2301FM-01-04S	AS2311FM-01-04S
	R 1/4	AS2201FM-02-04S	AS2211FM-02-04S	AS2301FM-02-04S	AS2311FM-02-04S
Ø 6	M5 x 0.8	AS1201FM-M5-06	AS1211FM-M5-06	AS1301FM-M5-06	AS1311FM-M5-06
	R 1/8	AS2201FM-01-06S	AS2211FM-01-06S	AS2301FM-01-06S	AS2311FM-01-06S
	R 1/4	AS2201FM-02-06S	AS2211FM-02-06S	AS2301FM-02-06S	AS2311FM-02-06S
Ø 8	R 1/8	AS2201FM-01-08S	AS2211FM-01-08S	AS2301FM-01-08S	AS2311FM-01-08S
	R 1/4	AS2201FM-02-08S	AS2211FM-02-08S	AS2301FM-02-08S	AS2311FM-02-08S
Ø 10	R 1/4	AS2201FM-02-10S	AS2211FM-02-10S	AS2301FM-02-10S	AS2311FM-02-10S

Note) For dimensions and other details refer to specific catalogue of the series at www.smc.eu



Made to Order

1 Lubricant: Vaseline X12

Example) AS1201FM-M5-23-X12

2 Grease-free (Seal: Fluorine-coated) + Restrictor (Without check valve) X21

Example) AS1201FM-M5-23-X21

Note 1) Not particle-free

Note 2) The restrictor is only compatible with the part number of the meter-out type.

3 Restrictor (Without check valve) X214

Example) AS1201FM-M5-23-X214

Note) The restrictor is only compatible with the part number of the meter-out type.

4 Clean Series 10-

Lubricant: Fluorine-based grease, Double package

Example) 10-AS1201FM-M5-23

- AS
- AS-FS
- AS-1F
- AS-P
- AS-F
- AS-W2D
- AS-X737
- AS-2F
- AS-1F-3
- AS-DPP
- ASD
- Uni-AS
- Uni-AS-FS
- Uni-AS-1F
- AS-FE
- AS-FG
- AS-FSG
- AS-1FG
- ASD-FG
- ASG
- AS-FPQ/
FPG
- AS-FM
- ASD-FM
- AS-F-D
- ASD-F-D
- AS-F-T
- ASD-F-T
- ASP
- ASV
- AS-R
- AS-Q
- Related

Speed Controller for Low Speed Operation

AS□1FM Series

In-line Type

■ Applicable tubing O.D. : Metric Size

Low Speed Control

How to Order

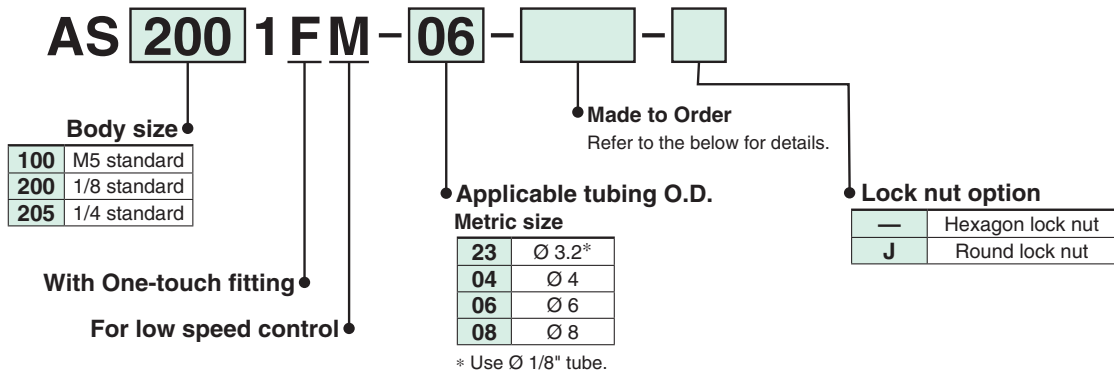

Model

Model	Applicable tubing O.D.			
	Metric size			
	3.2	4	6	8
AS1001FM	●	●	●	
AS2001FM		●	●	
AS2051FM			●	●

Specifications

Fluid	Air
Proof pressure	1.5 MPa
Max. operating pressure	1 MPa
Min. operating pressure	0.1 MPa
Ambient and fluid temperature	-5 to 60 °C (No freezing)
Applicable tubing material ^{Note 1)}	Nylon, Soft nylon, Polyurethane

Note 1) Use caution at the max. operating pressure when using soft nylon or polyurethane tubing. (For details, refer to the **WEB catalogue** at www.smc.eu)

Note 2) Brass parts are all electroless nickel plated.

The knob of the M5 type is black zinc chromate plated.

In-line Type

AS□1FM

Ideal for low speed control at 10 to 50 mm/sec



Applicable tubing O.D. [mm]	Model
	In-line type
∅ 3.2	AS1001FM-23
	AS1001FM-04
∅ 4	AS2001FM-04
	AS1001FM-06
∅ 6	AS2001FM-06
	AS2051FM-06
∅ 8	AS2051FM-08

For inch size, refer to the **WEB catalogue** at www.smc.eu

Made to Order

Made to Order

1 Lubricant: Vaseline

X12

Example) AS2001FM-04-X12

2 Grease-free (Seal: Fluorine-coated) + Restrictor (Without check valve)

X21

Example) AS2001FM-04-X21

Note) Not particle-free

3 Restrictor (Without check valve)

X214

Example) AS2001FM-04-X214

4 Clean Series

10-

Lubricant: Fluorine-based grease, Double package
Example) 10-AS2001FM-04

Dual Speed Controller for Low Speed Operation RoHS

ASD□30FM Series

Universal Type

■ Applicable tubing O.D. : Metric Size ■ Connection thread : M5, R

Speed Controllers

- AS
- AS-FS
- AS-1F
- AS-P
- AS-F
- AS-W2D
- AS-X737
- AS-2F
- AS-1F-3
- AS-DPP
- ASD
- Uni-AS
- Uni-AS-FS
- Uni-AS-1F
- AS-FE
- AS-FG
- AS-FSG
- AS-1FG
- ASD-FG
- ASG
- AS-FPQ/FPG
- AS-FM
- ASD-FM
- AS-F-D
- ASD-F-D
- AS-F-T
- ASD-F-T
- ASP
- ASV
- AS-R
- AS-Q
- Related

How to Order

Low Speed Control

Lurch Prevention

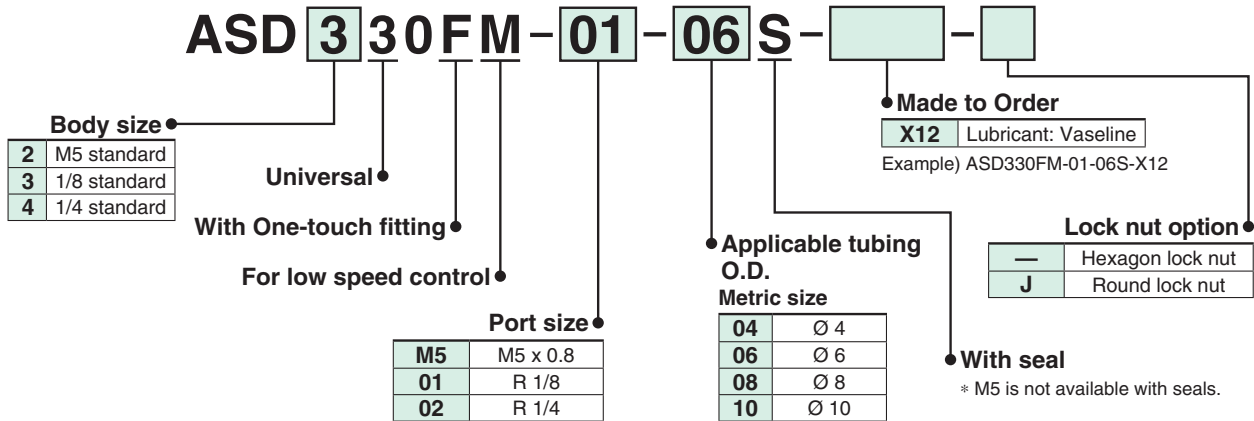

Model

Model	Port size	Applicable tubing O.D.			
		Metric size			
		4	6	8	10
ASD230FM-M5	M5 x 0.8	●	●		
ASD330FM-01	R 1/8		●	●	
ASD430FM-02	R 1/4		●	●	●

Specifications

Fluid	Air
Proof pressure	1.5 MPa
Max. operating pressure	1 MPa
Min. operating pressure	0.1 MPa
Ambient and fluid temperature	-5 to 60 °C (No freezing)
Applicable tubing material ^{Note 1)}	Nylon, Soft nylon, Polyurethane

Note 1) Use caution at the max. operating pressure when using soft nylon or polyurethane tubing. (For details, refer to the **WEB catalogue** at www.smc.eu)

Note 2) Brass parts are all electroless nickel plated. The lock nut of the meter-out type is zinc chromate plated (the round lock nut is electroless nickel plated), then, the knob of the M5 type and the lock nut of the meter-in type are black zinc chromate plated.

Universal Type

ASD□30FM

Two flow control valves and check valves integrated. Prevention of a stick-slip phenomenon, and speed control of a single acting cylinder. Stable speed control is achievable even with load fluctuations. Low speed control for small bore cylinders.



Symbol

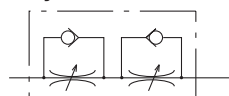

Applicable tubing O.D. [mm]	Connection thread	Model
		Universal type
Ø 4	M5 x 0.8	ASD230FM-M5-04
	M5 x 0.8	ASD230FM-M5-06
Ø 6	R 1/8	ASD330FM-01-06S
	R 1/4	ASD430FM-02-06S
Ø 8	R 1/8	ASD330FM-01-08S
	R 1/4	ASD430FM-02-08S
Ø 10	R 1/4	ASD430FM-02-10S

For inch size, refer to the **WEB catalogue** at www.smc.eu

Made to Order

Made to Order

1 Lubricant: Vaseline

X12

2 Clean Series

10-

Example) ASD230FM-M5-X12

Lubricant: Fluorine-based grease, Double package
Example) 10-ASD230FM-M5

AS□□□1F-D Series

Elbow Type/Universal Type

■Applicable tubing O.D. : Metric Size ■Connection thread : M5, R

How to Order

AS 2 2 1 1 F - 01 - 06 SD -

Body size

1	M5 standard
2	1/8, 1/4 standard
3	3/8 standard
4	1/2 standard

Type

2	Elbow
3	Universal

Control type

0	Meter-out
1	Meter-in

Applicable tubing O.D. Metric size

23	∅ 3.2*
04	∅ 4
06	∅ 6
08	∅ 8
10	∅ 10
12	∅ 12

* Use ∅ 1/8" tube.

Port size

M5	M5 x 0.8
01	R 1/8
02	R 1/4
03	R 3/8
04	R 1/2

With One-touch fitting

With sealant
Note) In case that connecting port is either M5 thread, it is not available with seal. With gasket is provided as standard.

Made to Order
Refer to next page for details.

Flow adjustable by flat head screwdriver For safety measures

Elbow type



Universal type



Model

Port size	Applicable tubing O.D.						Elbow type		Universal type	
	Metric size						Meter-out	Meter-in	Meter-out	Meter-in
	3.2	4	6	8	10	12				
M5 x 0.8	●	●	●				AS1201F-M5	AS1211F-M5	AS1301F-M5	AS1311F-M5
R 1/8	●	●	●	●	Note 1)	●	AS2201F-01	AS2211F-01	AS2301F-01	AS2311F-01
R 1/4		●	●	●	●		AS2201F-02	AS2211F-02	AS2301F-02	AS2311F-02
R 1/4			●	●	●	●	AS3201F-02	AS3211F-02	AS3301F-02	AS3311F-02
R 3/8			●	●	●	●	AS3201F-03	AS3211F-03	AS3301F-03	AS3311F-03
R 1/2					●	●	AS4201F-04	AS4211F-04	AS4301F-04	AS4311F-04

Note 1) Elbow type only

Note 2) Meter-out and meter-in types can be visually differentiated by the flow direction symbol on the resin body.

Specifications

Fluid	Air
Proof pressure	1.5 MPa
Max. operating pressure	1 MPa
Min. operating pressure	0.1 MPa
Ambient and fluid temperature	-5 to 60 °C (No freezing)
Applicable tubing material ^{Note1)}	Nylon, Soft nylon, Polyurethane

Note 1) Use caution at the max. operating pressure when using soft nylon or polyurethane tubing.

(For details, refer to the **WEB catalogue** at www.smc.eu)

Note 2) Brass parts are all electroless nickel plated, provided as standard.

For inch size, refer to the **WEB catalogue** at www.smc.eu

Elbow Type/Universal Type

AS□□□1F-D

Symbol
Flow Direction Symbols on Body

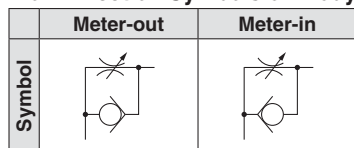

Applicable tubing O.D. [mm]	Uni thread	Model			
		Elbow type		Universal type	
		Meter-out	Meter-in	Meter-out	Meter-in
Ø 3.2	M5 x 0.8	AS1201F-M5-23D	AS1211F-M5-23D	AS1301F-M5-23D	AS1311F-M5-23D
	R 1/8	AS2201F-01-23SD	AS2211F-01-23SD	AS2301F-01-23SD	AS2311F-01-23SD
Ø 4	M5 x 0.8	AS1201F-M5-04D	AS1211F-M5-04D	AS1301F-M5-04D	AS1311F-M5-04D
	R 1/8	AS2201F-01-04SD	AS2211F-01-04SD	AS2301F-01-04SD	AS2311F-01-04SD
	R 1/4	AS2201F-02-04SD	AS2211F-02-04SD	AS2301F-02-04SD	AS2311F-02-04SD
Ø 6	M5 x 0.8	AS1201F-M5-06D	AS1211F-M5-06D	AS1301F-M5-06D	AS1311F-M5-06D
	R 1/8	AS2201F-01-06SD	AS2211F-01-06SD	AS2301F-01-06SD	AS2311F-01-06SD
	R 1/4	AS2201F-02-06SD	AS2211F-02-06SD	AS2301F-02-06SD	AS2311F-02-06SD
		AS3201F-02-06SD	AS3211F-02-06SD	AS3301F-02-06SD	AS3311F-02-06SD
R 3/8	AS3201F-03-06SD	AS3211F-03-06SD	AS3301F-03-06SD	AS3311F-03-06SD	
Ø 8	R 1/8	AS2201F-01-08SD	AS2211F-01-08SD	AS2301F-01-08SD	AS2311F-01-08SD
	R 1/4	AS2201F-02-08SD	AS2211F-02-08SD	AS2301F-02-08SD	AS2311F-02-08SD
		AS3201F-02-08SD	AS3211F-02-08SD	AS3301F-02-08SD	AS3311F-02-08SD
R 3/8	AS3201F-03-08SD	AS3211F-03-08SD	AS3301F-03-08SD	AS3311F-03-08SD	
Ø 10	R 1/8	AS2201F-01-10SD	AS2211F-01-10SD	—	—
	R 1/4	AS2201F-02-10SD	AS2211F-02-10SD	AS2301F-02-10SD	AS2311F-02-10SD
		AS3201F-02-10SD	AS3211F-02-10SD	AS3301F-02-10SD	AS3311F-02-10SD
	R 3/8	AS3201F-03-10SD	AS3211F-03-10SD	AS3301F-03-10SD	AS3311F-03-10SD
R 1/2	AS4201F-04-10SD	AS4211F-04-10SD	AS4301F-04-10SD	AS4311F-04-10SD	
Ø 12	R 1/4	AS3201F-02-12SD	AS3211F-02-12SD	AS3301F-02-12SD	AS3311F-02-12SD
	R 3/8	AS3201F-03-12SD	AS3211F-03-12SD	AS3301F-03-12SD	AS3311F-03-12SD
	R 1/2	AS4201F-04-12SD	AS4211F-04-12SD	AS4301F-04-12SD	AS4311F-04-12SD

Note) For dimensions and other details refer to specific catalogue of the series at www.smc.eu



Made to Order

1 Lubricant: Vaseline **X12**

Example) AS1201F-M5-23D-X12

2 Grease-free (Seal: Fluorine-coated) + Restrictor (Without check valve) **X21**

Example) AS1201F-M5-23D-X21

Note 1) Not particle-free

Note 2) The restrictor is only compatible with the part number of the meter-out type.

3 Restrictor (Without check valve) **X214**

Example) AS1201F-M5-23D-X214

Note) The restrictor is only compatible with the part number of the meter-out type.

- AS
- AS-FS
- AS-1F
- AS·P
- AS·F
- AS-W2D
- AS-X737
- AS-2F
- AS-1F-3
- AS-DPP
- ASD
- Uni-AS
- Uni-AS-FS
- Uni-AS-1F
- AS-FE
- AS-FG
- AS-FSG
- AS-1FG
- ASD-FG
- ASG
- AS-FPQ/FPG
- AS·FM
- ASD·FM
- AS·F-D
- ASD·F-D
- AS·F-T
- ASD·F-T
- ASP
- ASV
- AS-R
- AS-Q
- Related

Speed Controller Adjustable by Flat Head Screwdriver

AS□1F-D Series

In-line Type

■ Applicable tubing O.D. : Metric Size

How to Order

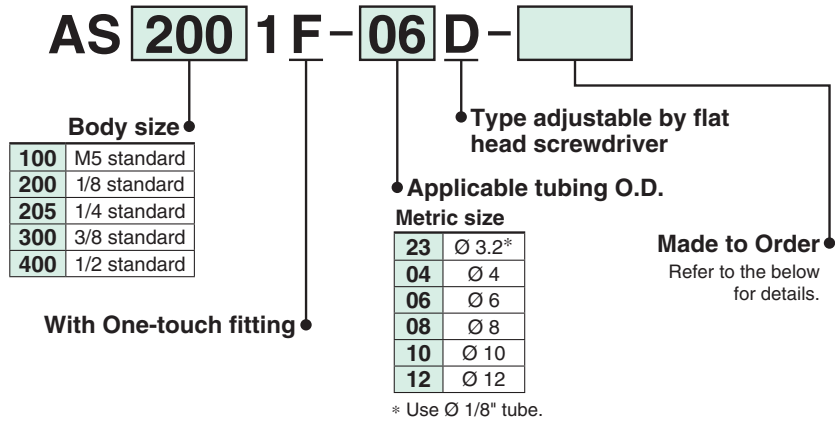

Model

Model	Applicable tubing O.D.					
	Metric size					
	3.2	4	6	8	10	12
AS1001F	●	●	●			
AS2001F		●	●			
AS2051F			●	●		
AS3001F			●	●	●	●
AS4001F					●	●

Specifications

Fluid	Air
Proof pressure	1.5 MPa
Max. operating pressure	1 MPa
Min. operating pressure	0.1 MPa
Ambient and fluid temperature	-5 to 60 °C (No freezing)
Applicable tubing material ^{Note 1)}	Nylon, Soft nylon, Polyurethane

Note 1) Use caution at the max. operating pressure when using soft nylon or polyurethane tubing. (For details, refer to the **WEB catalogue** at www.smc.eu)

Note 2) Brass parts are all electroless nickel plated.

In-line Type

AS□1F-D

Flow adjustable by flat head screwdriver
For safety measures



Applicable tubing O.D. [mm]	Model	Applicable tubing O.D. [mm]	Model
	In-line type		In-line type
∅ 3.2	AS1001F-23D	∅ 8	AS2051F-08D
	AS1001F-04D		AS3001F-08D
∅ 4	AS2001F-04D	∅ 10	AS3001F-10D
	AS1001F-06D		AS4001F-10D
∅ 6	AS2001F-06D	∅ 12	AS3001F-12D
	AS2051F-06D		AS4001F-12D
	AS3001F-06D		

For inch size, refer to the **WEB catalogue** at www.smc.eu

Made to Order

Made to Order

1 Lubricant: Vaseline

X12

Example) AS1001F-23D-X12

2 Grease-free (Seal: Fluorine-coated) + Restrictor (Without check valve)

X21

Example) AS1001F-23D-X21

Note) Not particle-free

3 Restrictor (Without check valve)

X214

Example) AS1001F-23D-X214

243

Dual Speed Controller Adjustable by Flat Head Screwdriver



Speed
Controllers

ASD□30F-D Series

Universal Type

■Applicable tubing O.D. : Metric Size ■Connection thread : M5, R

Lurch Prevention

How to Order

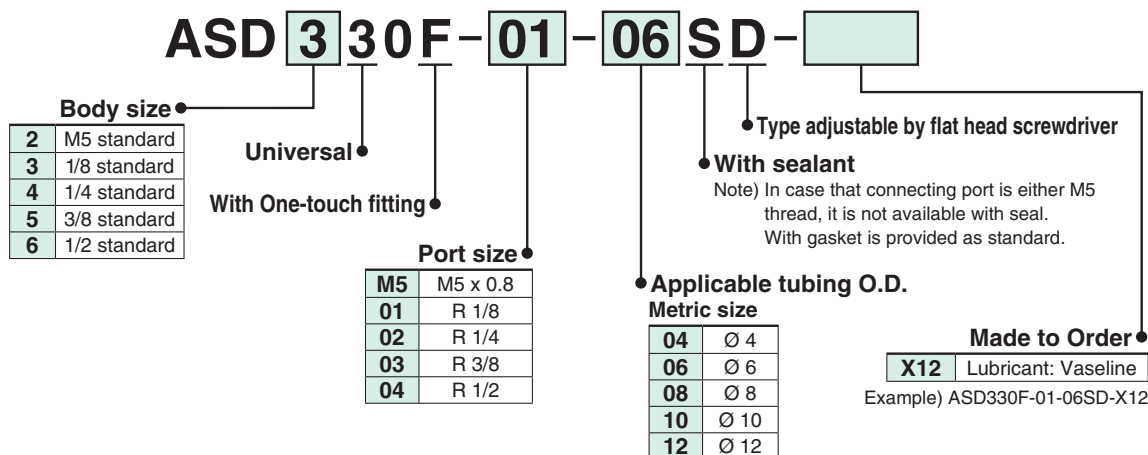

Model

Model	Port size	Applicable tubing O.D.				
		Metric size				
		4	6	8	10	12
ASD230F-M5	M5 x 0.8	●	●			
ASD330F-01	R 1/8		●	●		
ASD430F-02	R 1/4		●	●	●	
ASD530F-02	R 1/4		●	●	●	●
ASD530F-03	R 3/8		●	●	●	●
ASD630F-04	R 1/2				●	●

Specifications

Fluid	Air
Proof pressure	1.5 MPa
Max. operating pressure	1 MPa
Min. operating pressure	0.1 MPa
Ambient and fluid temperature	-5 to 60°C (No freezing)
Applicable tubing material <small>Note 1)</small>	Nylon, Soft nylon, Polyurethane

Note 1) Use caution at the max. operating pressure when using soft nylon or polyurethane tubing. (For details, refer to the **WEB catalogue** at www.smc.eu)

Note 2) Brass parts are all electroless nickel plated.

Universal Type

ASD□30F-D

Prevention of stick-slip phenomenon, and speed control of a single acting cylinder. Flow adjustable by flat head screwdriver. For safety measures

Symbol

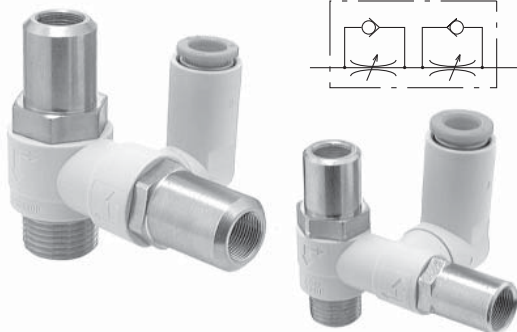
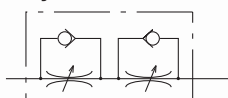

Applicable tubing O.D. [mm]	Connection thread	Model
		Universal type
Ø 4	M5 x 0.8	ASD230F-M5-04D
	M5 x 0.8	ASD230F-M5-06D
Ø 6	R 1/8	ASD330F-01-06SD
	R 1/4	ASD430F-02-06SD
	R 1/4	ASD530F-02-06SD
	R 3/8	ASD530F-03-06SD
Ø 8	R 1/8	ASD330F-01-08SD
	R 1/4	ASD430F-02-08SD
	R 3/8	ASD530F-03-08SD

For inch size, refer to the **WEB catalogue** at www.smc.eu

Applicable tubing O.D. [mm]	Connection thread	Model
		Universal type
Ø 10	R 1/4	ASD430F-02-10SD
	R 1/4	ASD530F-02-10SD
	R 3/8	ASD530F-03-10SD
	R 1/2	ASD630F-04-10SD
Ø 12	R 1/4	ASD530F-02-12SD
	R 3/8	ASD530F-03-12SD
	R 1/2	ASD630F-04-12SD

Made to Order

Made to Order

1 Lubricant: Vaseline

X12

Example) ASD230F-M5-04D-X12



- AS
- AS-FS
- AS-1F
- AS-P
- AS-F
- AS-W2D
- AS-X737
- AS-2F
- AS-1F-3
- AS-DPP
- ASD
- Uni-AS
- Uni-AS-FS
- Uni-AS-1F
- AS-FE
- AS-FG
- AS-FSG
- AS-1FG
- ASD-FG
- ASG
- AS-FPQ/FPG
- AS-FM
- ASD-FM
- AS-F-D
- ASD-F-D
- AS-F-T
- ASD-F-T
- ASP
- ASV
- AS-R
- AS-Q
- Related

Tamper Proof Speed Controller

RoHS

AS□□□1F-T Series

Elbow Type/Universal Type

■Applicable tubing O.D. : Metric Size ■Connection thread : M5, R

How to Order

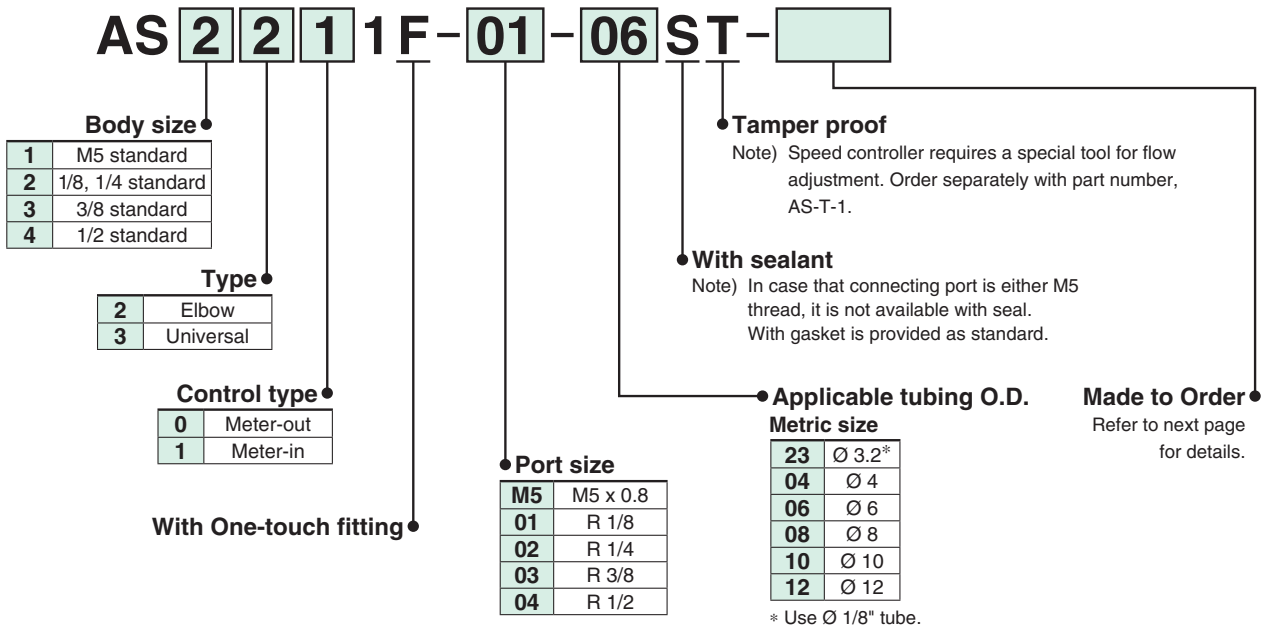

Able to adjust flow by a special tool
For safety measures

Elbow type

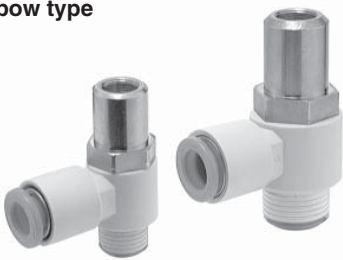

Universal type



Special tool (AS-T-1)



Model

Port size	Applicable tubing O.D.						Elbow type		Universal type	
	Metric size						Meter-out	Meter-in	Meter-out	Meter-in
	3.2	4	6	8	10	12				
M5 x 0.8	●	●	●				AS1201F-M5	AS1211F-M5	AS1301F-M5	AS1311F-M5
R 1/8	●	●	●	●	Note 1)		AS2201F-01	AS2211F-01	AS2301F-01	AS2311F-01
R 1/4		●	●	●	●		AS2201F-02	AS2211F-02	AS2301F-02	AS2311F-02
R 1/4			●	●	●	●	AS3201F-02	AS3211F-02	AS3301F-02	AS3311F-02
R 3/8			●	●	●	●	AS3201F-03	AS3211F-03	AS3301F-03	AS3311F-03
R 1/2					●	●	AS4201F-04	AS4211F-04	AS4301F-04	AS4311F-04

Note 1) Elbow type only

Note 2) Meter-out and meter-in types can be visually differentiated by the flow direction symbol on the resin body.

Specifications

Fluid	Air
Proof pressure	1.5 MPa
Max. operating pressure	1 MPa
Min. operating pressure	0.1 MPa
Ambient and fluid temperature	-5 to 60 °C (No freezing)
Applicable tubing material ^{Note 1)}	Nylon, Soft nylon, Polyurethane

Note 1) Use caution at the max. operating pressure when using soft nylon or polyurethane tubing. (For details, refer to the **WEB catalogue** at www.smc.eu)

Note 2) Brass parts are all electroless nickel plated, provided as standard.

For inch size, refer to the **WEB catalogue** at www.smc.eu

Elbow Type/Universal Type

AS□□□1F-T

Symbol

Flow Direction Symbols on Body

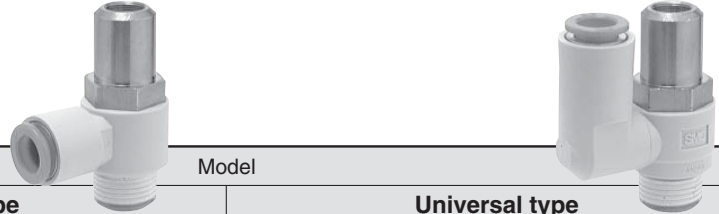
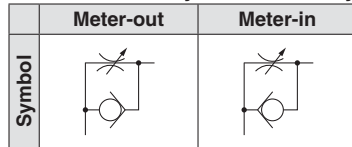

Applicable tubing O.D. [mm]	Uni thread	Model			
		Elbow type		Universal type	
		Meter-out	Meter-in	Meter-out	Meter-in
Ø 3.2	M5 x 0.8	AS1201F-M5-23T	AS1211F-M5-23T	AS1301F-M5-23T	AS1311F-M5-23T
	R 1/8	AS2201F-01-23ST	AS2211F-01-23ST	AS2301F-01-23ST	AS2311F-01-23ST
Ø 4	M5 x 0.8	AS1201F-M5-04T	AS1211F-M5-04T	AS1301F-M5-04T	AS1311F-M5-04T
	R 1/8	AS2201F-01-04ST	AS2211F-01-04ST	AS2301F-01-04ST	AS2311F-01-04ST
	R 1/4	AS2201F-02-04ST	AS2211F-02-04ST	AS2301F-02-04ST	AS2311F-02-04ST
Ø 6	M5 x 0.8	AS1201F-M5-06T	AS1211F-M5-06T	AS1301F-M5-06T	AS1311F-M5-06T
	R 1/8	AS2201F-01-06ST	AS2211F-01-06ST	AS2301F-01-06ST	AS2311F-01-06ST
	R 1/4	AS2201F-02-06ST	AS2211F-02-06ST	AS2301F-02-06ST	AS2311F-02-06ST
		AS3201F-02-06ST	AS3211F-02-06ST	AS3301F-02-06ST	AS3311F-02-06ST
R 3/8	AS3201F-03-06ST	AS3211F-03-06ST	AS3301F-03-06ST	AS3311F-03-06ST	
Ø 8	R 1/8	AS2201F-01-08ST	AS2211F-01-08ST	AS2301F-01-08ST	AS2311F-01-08ST
	R 1/4	AS2201F-02-08ST	AS2211F-02-08ST	AS2301F-02-08ST	AS2311F-02-08ST
		AS3201F-02-08ST	AS3211F-02-08ST	AS3301F-02-08ST	AS3311F-02-08ST
	R 3/8	AS3201F-03-08ST	AS3211F-03-08ST	AS3301F-03-08ST	AS3311F-03-08ST
Ø 10	R 1/8	AS2201F-01-10ST	AS2211F-01-10ST	—	—
	R 1/4	AS2201F-02-10ST	AS2211F-02-10ST	AS2301F-02-10ST	AS2311F-02-10ST
		AS3201F-02-10ST	AS3211F-02-10ST	AS3301F-02-10ST	AS3311F-02-10ST
	R 3/8	AS3201F-03-10ST	AS3211F-03-10ST	AS3301F-03-10ST	AS3311F-03-10ST
	R 1/2	AS4201F-04-10ST	AS4211F-04-10ST	AS4301F-04-10ST	AS4311F-04-10ST
Ø 12	R 1/4	AS3201F-02-12ST	AS3211F-02-12ST	AS3301F-02-12ST	AS3311F-02-12ST
	R 3/8	AS3201F-03-12ST	AS3211F-03-12ST	AS3301F-03-12ST	AS3311F-03-12ST
	R 1/2	AS4201F-04-12ST	AS4211F-04-12ST	AS4301F-04-12ST	AS4311F-04-12ST

Note) For dimensions and other details refer to specific catalogue of the series at www.smc.eu



Made to Order

1 Lubricant: Vaseline **X12**

Example) AS1201F-M5-23T-X12

2 Grease-free (Seal: Fluorine-coated) + Restrictor (Without check valve) **X21**

Example) AS1201F-M5-23T-X21

Note 1) Not particle-free

Note 2) The restrictor is only compatible with the part number of the meter-out type.

3 Restrictor (Without check valve) **X214**

Example) AS1201F-M5-23T-X214

Note) The restrictor is only compatible with the part number of the meter-out type.

- AS
- AS-FS
- AS-1F
- AS·P
- AS·F
- AS-W2D
- AS-X737
- AS-2F
- AS-1F-3
- AS-DPP
- ASD
- Uni-AS
- Uni-AS-FS
- Uni-AS-1F
- AS-FE
- AS-FG
- AS-FSG
- AS-1FG
- ASD-FG
- ASG
- AS-FPQ/FPG
- AS-FM
- ASD-FM
- AS-F-D
- ASD-F-D
- AS-F-T
- ASD-F-T
- ASP
- ASV
- AS-R
- AS-Q
- Related

Tamper Proof Speed Controller

AS□1F-T Series

In-line Type

■ Applicable tubing O.D. : Metric Size

How to Order

AS 200 1 F - 06 T -

Body size

100	M5 standard
200	1/8 standard
205	1/4 standard
300	3/8 standard
400	1/2 standard

With One-touch fitting

Made to Order
Refer to next page for details.

Tamper proof
Note) Speed controller requires a special tool for flow adjustment.
Order separately with part number, AS-T-1.

Applicable tubing O.D.
Metric size

23	∅ 3.2*	08	∅ 8
04	∅ 4	10	∅ 10
06	∅ 6	12	∅ 12

* Use ∅ 1/8" tube.

Model

Model	Applicable tubing O.D.					
	Metric size					
	3.2	4	6	8	10	12
AS1001F	●	●	●			
AS2001F		●	●			
AS2051F			●	●		
AS3001F			●	●	●	●
AS4001F					●	●

Specifications

Fluid	Air
Proof pressure	1.5 MPa
Max. operating pressure	1 MPa
Min. operating pressure	0.1 MPa
Ambient and fluid temperature	-5 to 60 °C (No freezing)
Applicable tubing material ^{Note 1)}	Nylon, Soft nylon, Polyurethane

Note 1) Use caution at the max. operating pressure when using soft nylon or polyurethane tubing. (For details, refer to the **WEB catalogue** at www.smc.eu)

Note 2) Brass parts are all electroless nickel plated.

In-line Type

AS□1F-T

Able to adjust flow by a special tool
For safety measures



Applicable tubing O.D. [mm]	Model
	In-line type
∅ 3.2	AS1001F-23T
	AS1001F-04T
∅ 4	AS2001F-04T
	AS1001F-06T
∅ 6	AS2001F-06T
	AS2051F-06T
	AS3001F-06T

Applicable tubing O.D. [mm]	Model
	In-line type
∅ 8	AS2051F-08T
	AS3001F-08T
∅ 10	AS3001F-10T
	AS4001F-10T
∅ 12	AS3001F-12T
	AS4001F-12T

For inch size, refer to the **WEB catalogue** at www.smc.eu

Made to Order

Made to Order

1 Lubricant: Vaseline

X12

Example) AS1001F-23T-X12

2 Grease-free (Seal: Fluorine-coated) + Restrictor (Without check valve)

X21

Example) AS1001F-23T-X21

Note) Not particle-free

3 Restrictor (Without check valve)

X214

Example) AS1001F-23T-X214

Tamper Proof Dual Speed Controller



ASD□30F-T Series

Universal Type

■Applicable tubing O.D. : Metric Size ■Connection thread : M5, R

Lurch Prevention

How to Order

ASD 3 30F-01-06 ST- []

Body size

2	M5 standard
3	1/8 standard
4	1/4 standard
5	3/8 standard
6	1/2 standard

Universal

With One-touch fitting

Port size

M5	M5 x 0.8
01	R 1/8
02	R 1/4
03	R 3/8
04	R 1/2

Tamper proof
Note) Speed controller requires a special tool for flow adjustment.
Order separately with part number, AS-T-1.

With sealant
Note) In case that connecting port is either M5 thread, it is not available with seal.
With gasket is provided as standard.

Applicable tubing O.D.

Metric size

04	Ø 4
06	Ø 6
08	Ø 8
10	Ø 10
12	Ø 12

Made to Order

X12 Lubricant: Vaseline
Example) ASD330F-01-06ST-X12

Model

Model	Port size	Applicable tubing O.D.				
		Metric size				
		4	6	8	10	12
ASD230F-M5	M5 x 0.8	●	●			
ASD330F-01	R 1/8		●	●		
ASD430F-02	R 1/4		●	●	●	
ASD530F-02	R 1/4		●	●	●	●
ASD530F-03	R 3/8		●	●	●	●
ASD630F-04	R 1/2				●	●

Specifications

Fluid	Air
Proof pressure	1.5 MPa
Max. operating pressure	1 MPa
Min. operating pressure	0.1 MPa
Ambient and fluid temperature	-5 to 60 °C (No freezing)
Applicable tubing material <small>Note 1)</small>	Nylon, Soft nylon, Polyurethane

Note 1) Use caution at the max. operating pressure when using soft nylon or polyurethane tubing. (For details, refer to the **WEB catalogue** at www.smc.eu)

Note 2) Brass parts are all electroless nickel plated, provided as standard.

Universal Type

ASD□30F-T

Prevention of stick-slip phenomenon, and speed control of a single acting cylinder.

Able to adjust flow by a special tool
For safety measures

Symbol

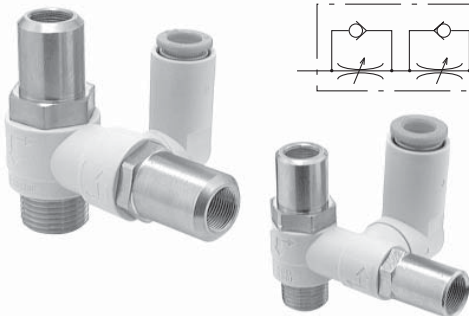

Applicable tubing O.D. [mm]	Connection thread	Model
		Universal type
Ø 4	M5 x 0.8	ASD230F-M5-04T
	M5 x 0.8	ASD230F-M5-06T
	R 1/8	ASD330F-01-06ST
Ø 6	R 1/8	ASD330F-01-06ST
	R 1/4	ASD430F-02-06ST
		ASD530F-02-06ST
	R 3/8	ASD530F-03-06ST
	R 1/8	ASD330F-01-08ST
Ø 8	R 1/4	ASD430F-02-08ST
		ASD530F-02-08ST
	R 3/8	ASD530F-03-08ST

Applicable tubing O.D. [mm]	Connection thread	Model
		Universal type
Ø 10	R 1/4	ASD430F-02-10ST
		ASD530F-02-10ST
	R 3/8	ASD530F-03-10ST
Ø 12	R 1/2	ASD630F-04-10ST
	R 1/4	ASD530F-02-12ST
	R 3/8	ASD530F-03-12ST
	R 1/2	ASD630F-04-12ST

For inch size, refer to the **WEB catalogue** at www.smc.eu



Made to Order

1 Lubricant: Vaseline

X12

Example) ASD230F-M5-04T-X12

Speed Controller with Pilot Check Valve RoHS

ASP□30F Series

Universal Type

■ Applicable tubing O.D. : Metric Size ■ Connection thread : R

Drop Prevention

How to Order

ASP 3 30F - 01 - 06 S - [] - []

- Pilot check valve**
- Body size**

3	1/8 standard
4	1/4 standard
5	3/8 standard
6	1/2 standard
- Universal**
- With One-touch fitting**
- With seal**
- Applicable tubing O.D. Metric size**

06	∅ 6
08	∅ 8
10	∅ 10
12	∅ 12
- Lock nut option**

—	Hexagon lock nut
J	Round lock nut
- Made to Order**

X12	Lubricant: Vaseline
-----	---------------------

Example) ASP330F-01-08S-X12
- Port size**

Symbol	Cylinder side	Pilot port
01	R 1/8	M5 x 0.8
02	R 1/4	Rc 1/8
03	R 3/8	Rc 1/8
04	R 1/2	Rc 1/4

Model

Model	Port size	Applicable tubing O.D.				Pilot port
		Metric size				
		16	8	10	12	
ASP330F-01	R 1/8	●	●			M5 x 0.8
ASP430F-02	R 1/4	●	●			Rc 1/8
ASP530F-03	R 3/8		●	●		Rc 1/8
ASP630F-04	R 1/2			●	●	Rc 1/4

Note) Brass parts are all electroless nickel plated.

Specifications

Fluid	Air
Proof pressure	1.5 MPa
Max. operating pressure	1 MPa
Min. operating pressure	0.1 MPa
Pilot check valve operating pressure	More than 50 % the operating pressure (Over 0.1 MPa)
Ambient and fluid temperature	-5 to 60 °C (No freezing)
Applicable tubing material	Nylon, Soft nylon, Polyurethane

Note 1) Use caution at the max. operating pressure when using soft nylon or polyurethane tubing. (For details, refer to the **WEB catalogue** at www.smc.eu)

Universal Type

ASP□30F

Built-in pilot check valve for drop prevention.
Temporary intermediate stop. Emergency stop

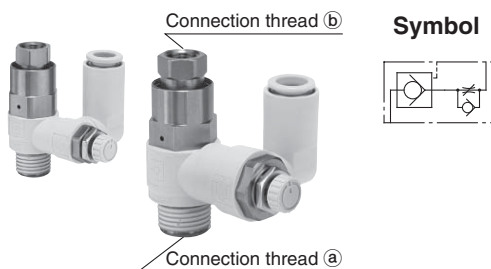

Applicable tubing O.D. [mm]	Connection thread (a) (cylinder side)	Connection thread (b) (pilot port)	Model
			Universal type
∅ 6	R 1/8	M5 x 0.8	ASP330F-01-06S
	R 1/4	Rc 1/8	ASP430F-02-06S
∅ 8	R 1/8	M5 x 0.8	ASP330F-01-08S
	R 1/4	Rc 1/8	ASP430F-02-08S
	R 3/8	Rc 1/8	ASP530F-03-08S
∅ 10	R 3/8	Rc 1/8	ASP530F-03-10S
	R 1/2	Rc 1/4	ASP630F-04-10S
∅ 12	R 1/2	Rc 1/4	ASP630F-04-12S

For inch size, refer to the **WEB catalogue** at www.smc.eu

Made to Order

Made to Order

1 Lubricant: Vaseline

X12

Example) ASP330F-01-06S-X12

Speed Exhaust Controller

RoHS

ASV Series

Elbow Type/Tee Type

■ Applicable tubing O.D. : Metric Size ■ Connection thread : M, R

Spatter Proof

Quick Exhaust

How to Order

(Tee type only)

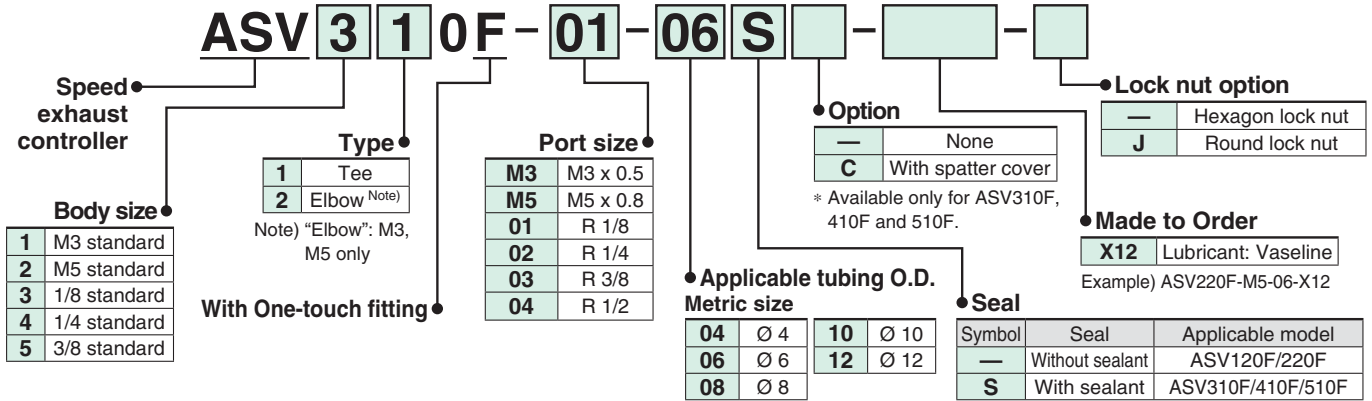

Model

Model	Port size	Applicable tubing O.D.				
		Metric size				
		4	6	8	10	12
ASV120F-M3	M3 x 0.5	●				
ASV220F-M5	M5 x 0.8	●	●			
ASV310F-01	R 1/8		●	●		
ASV310F-02	R 1/4		●	●		
ASV410F-01	R 1/8			●	●	
ASV410F-02	R 1/4			●	●	
ASV410F-03	R 3/8			●	●	
ASV510F-02	R 1/4				●	●
ASV510F-03	R 3/8				●	●
ASV510F-04	R 1/2				●	●

Specifications

Series	ASV120F	ASV220F	ASV310F/410F	ASV510F
Fluid	Air			
Proof pressure	1.5 MPa			
Max. operating pressure	1 MPa			
Min. operating pressure	0.1 MPa			
Ambient and fluid temperature	-5 to 60 °C (No freezing)			
Applicable tubing material (Note)	Nylon, Soft nylon, Polyurethane			
Option	Round lock nut		With spatter cover, Round lock nut	

Note 1) Use caution at the max. operating pressure when using soft nylon or polyurethane tubing. (For details, refer to the WEB catalogue at www.smc.eu)

Elbow Type/Tee

ASV

Integration of a quick exhaust valve and an exhaust restrictor permits high-speed cylinder operation.

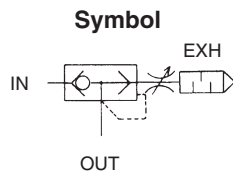

Applicable tubing O.D. [mm]	Connection thread	Model
		Elbow
Ø 4	M3 x 0.5	ASV120F-M3-04
	M5 x 0.8	ASV220F-M5-04
Ø 6	M5 x 0.8	ASV220F-M5-06
Ø 6	R 1/8	ASV310F-01-06S
	R 1/4	ASV310F-02-06S
Ø 8	R 1/8	ASV310F-01-08S
	R 1/4	ASV310F-02-08S
Ø 8	R 1/8	ASV410F-01-08S

Applicable tubing O.D. [mm]	Connection thread	Model
		Tee
Ø 8	R 1/4	ASV410F-02-08S
	R 3/8	ASV410F-03-08S
Ø 10	R 1/8	ASV410F-01-10S
	R 1/4	ASV410F-02-10S
	R 3/8	ASV410F-03-10S
	R 1/4	ASV510F-02-10S
	R 3/8	ASV510F-03-10S
Ø 10	R 1/2	ASV510F-04-10S
	R 1/4	ASV510F-02-12S
	R 3/8	ASV510F-03-12S
Ø 12	R 1/2	ASV510F-04-12S

Made to Order

Made to Order

1 Lubricant: Vaseline

X12

Example) ASV120F-M3-04-X12

Note) Only for ASV120F and ASV220F



Speed Controllers
AS
AS-FS
AS-1F
AS-P
AS-F
AS-W2D
AS-X737
AS-2F
AS-1F-3
AS-DPP
ASD
Uni-AS
Uni-AS-FS
Uni-AS-1F
AS-FE
AS-FG
AS-FSG
AS-1FG
ASD-FG
ASG
AS-FPQ/FPG
AS-FM
ASD-FM
AS-F-D
ASD-F-D
AS-F-T
ASD-F-T
ASP
ASV
AS-R
AS-Q
Related

Air Saving Speed Controller

RoHS

Push-lock type

AS-R / AS-Q Series

Elbow Type

■ Applicable tubing O.D. : Metric Size ■ Connection thread : R, G

How to Order

AS-R



With pressure reduction function

With pressure reduction function

* Knob color: White

AS-Q



With rapid supply and exhaust function

With rapid supply and exhaust function

* Knob color: Light blue

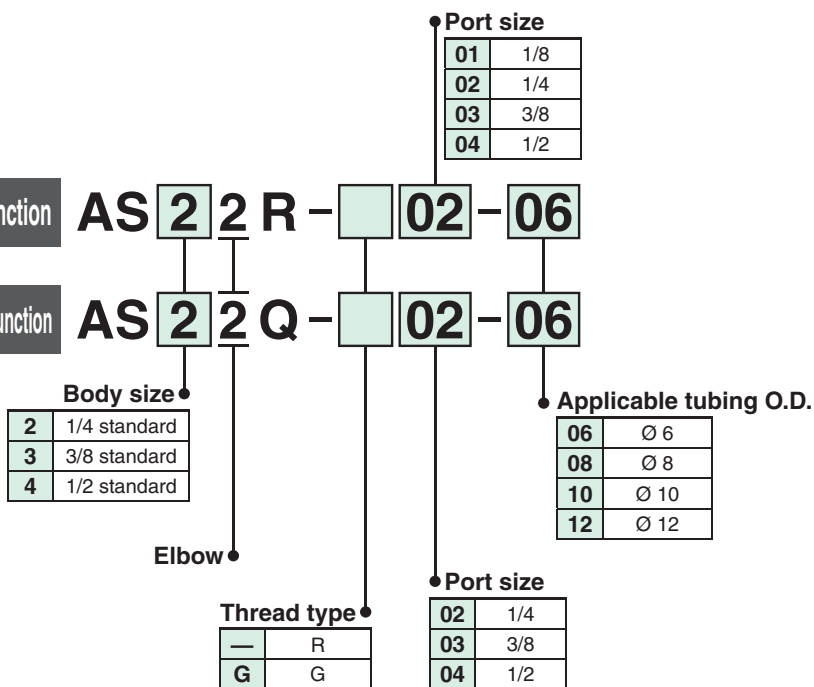

Model

Model	Port size	Applicable tubing O.D.											
		Metric size (Applicable thread: R, G)				Inch size (Applicable thread: NPT)							
		6	8	10	12	1/4"	5/16"	3/8"	1/2"				
AS22R-□01-□	—	1/8	●	●	●	●	●	●	●	●	●	●	●
AS22R-□02-□	AS22Q-□02-□	1/4	●	●	●	●	●	●	●	●	●	●	●
AS32R-□02-□	AS32Q-□02-□	1/4	●	●	●	●	●	●	●	●	●	●	●
AS32R-□03-□	AS32Q-□03-□	3/8	●	●	●	●	●	●	●	●	●	●	●
AS42R-□03-□	AS42Q-□03-□	3/8	●	●	●	●	●	●	●	●	●	●	●
AS42R-□04-□	AS42Q-□04-□	1/2	●	●	●	●	●	●	●	●	●	●	●

Flow Direction Symbols on Body

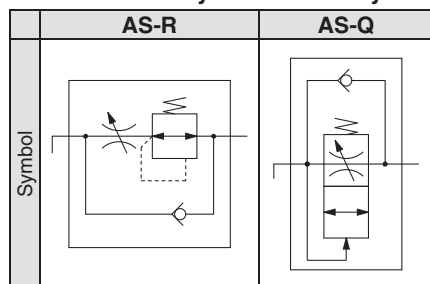

Specifications

Item	With pressure reduction function	With rapid supply and exhaust function
	AS-R	AS-Q
Fluid	Air	
Proof pressure	1.05 MPa	
Maximum operating pressure	0.7 MPa	
Minimum operating pressure	0.3 MPa	
Set pressure	0.2 MPa	—
(Supply pressure at 0.5 MPa)	Set pressure for pressure reduction function	Minimum pressure for rapid supply function initiation
Ambient and fluid temperature	-5 to 60°C (No freezing)	
Applicable tubing material	Nylon, Soft nylon, Polyurethane*1 FEP, PFA	

*1 Use caution at the maximum operating pressure when using soft nylon or polyurethane tubing. (For details, refer to the **Web Catalog** or Best Pneumatics.)

Air Saving Valve

RoHS

Speed
Controllers

Push-lock type

ASR / ASQ Series

Elbow Type

■Applicable tubing O.D. : Metric Size ■Connection thread : R

40 % reduction in air consumption

It is not necessary to supply high pressure to both sides of the piston operation. It is enough to supply pressure (0.2 MPa) that ensures only smooth operation within the set time to the non-working side. Reduction system with the PFC valve and QFC valve cuts the consumption amount by 40 %, reducing running costs and equipment costs greatly.

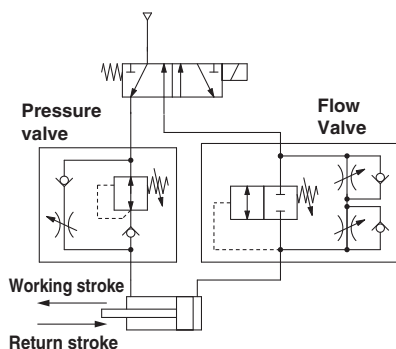

Pressure Valve Series ASR

Regulator with check valve + Speed controller



Regulator with check valve and flow control valve integrated into a single construction

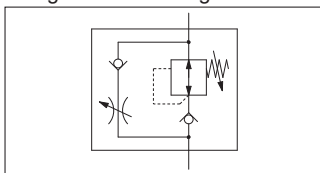

Flow Valve Series ASQ

Quick supply and exhaust valve + Speed controller (Meter-in, Meter-out)



Pilot valve and two-way flow control valve integrated into a single construction

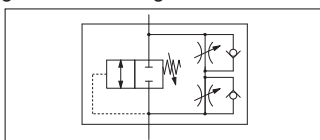

How to Order

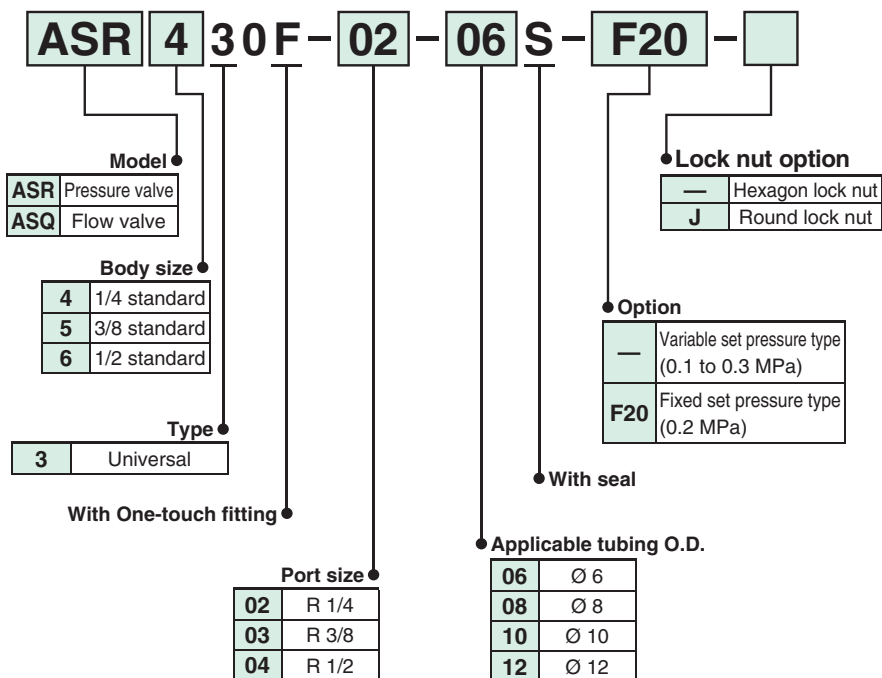

Model

Model		Port size	Applicable tubing O.D. [mm]			
Pressure valve	Flow Valve		6	8	10	12
ASR430F-02	ASQ430F-02	R 1/4	●	●	●	
ASR530F-02	ASQ530F-02	R 1/4	●	●	●	●
ASR530F-03	ASQ530F-03	R 3/8	●	●	●	●
ASR630F-03	ASQ630F-03	R 3/8			●	●
ASR630F-04	ASQ630F-04	R 1/2			●	●

Specifications

Fluid		Air
Proof pressure		1.5 MPa
Maximum operating pressure		1 MPa
Set pressure range	Variable	0.1 to 0.3 MPa
	Fixed (option)	0.2 MPa
Ambient and fluid temperature		-5 to 60 °C (No freezing)
Applicable tubing material		Nylon, Soft nylon, Polyurethane

AS

AS-FS

AS-1F

AS-P

AS-F

AS-W2D

AS-X737

AS-2F

AS-1F-3

AS-DPP

ASD

Uni-AS

Uni-AS-FS

Uni-AS-1F

AS-FE

AS-FG

AS-FSG

AS-1FG

ASD-FG

ASG

AS-FPQ/
FPG

AS-FM

ASD-FM

AS-F-D

ASD-F-D

AS-F-T

ASD-F-T

ASP

ASV

AS-R
AS-Q

Related

Air Saving Valve Pressure Valve/Flow Valve

ASR/ASQ Series

Pressure valve: ASR



Variable Set Pressure Type

Applicable tubing O.D. [mm]	Connection thread	Model
Ø 6	R 1/4	ASR430F-02-06S
	R 1/4	ASR530F-02-06S
	R 3/8	ASR530F-03-06S
Ø 8	R 1/4	ASR430F-02-08S
	R 1/4	ASR530F-02-08S
	R 3/8	ASR530F-03-08S
Ø 10	R 1/4	ASR430F-02-10S
	R 1/4	ASR530F-02-10S
	R 3/8	ASR530F-03-10S
	R 3/8	ASR630F-03-10S
Ø 12	R 1/2	ASR630F-04-10S
	R 1/4	ASR530F-02-12S
	R 3/8	ASR530F-03-12S
	R 3/8	ASR630F-03-12S
	R 1/2	ASR630F-04-12S

Fixed Set Pressure Type

Applicable tubing O.D. [mm]	Connection thread	Model
Ø 6	R 1/4	ASR430F-02-06S-F20
	R 1/4	ASR530F-02-06S-F20
	R 3/8	ASR530F-03-06S-F20
Ø 8	R 1/4	ASR430F-02-08S-F20
	R 1/4	ASR530F-02-08S-F20
	R 3/8	ASR530F-03-08S-F20
Ø 10	R 1/4	ASR430F-02-10S-F20
	R 1/4	ASR530F-02-10S-F20
	R 3/8	ASR530F-03-10S-F20
	R 3/8	ASR630F-03-10S-F20
Ø 12	R 1/2	ASR630F-04-10S-F20
	R 1/4	ASR530F-02-12S-F20
	R 3/8	ASR530F-03-12S-F20
	R 3/8	ASR630F-03-12S-F20
	R 1/2	ASR630F-04-12S-F20

Flow valve: ASQ



Variable Set Pressure Type

Applicable tubing O.D. [mm]	Connection thread	Model
Ø 6	R 1/4	ASQ430F-02-06S
	R 1/4	ASQ530F-02-06S
	R 3/8	ASQ530F-03-06S
Ø 8	R 1/4	ASQ430F-02-08S
	R 1/4	ASQ530F-02-08S
	R 3/8	ASQ530F-03-08S
Ø 10	R 1/4	ASQ430F-02-10S
	R 1/4	ASQ530F-02-10S
	R 3/8	ASQ530F-03-10S
	R 3/8	ASQ630F-03-10S
Ø 12	R 1/2	ASQ630F-04-10S
	R 1/4	ASQ530F-02-12S
	R 3/8	ASQ530F-03-12S
	R 3/8	ASQ630F-03-12S
	R 1/2	ASQ630F-04-12S

Fixed Set Pressure Type

Applicable tubing O.D. [mm]	Connection thread	Model
Ø 6	R 1/4	ASQ430F-02-06S-F20
	R 1/4	ASQ530F-02-06S-F20
	R 3/8	ASQ530F-03-06S-F20
Ø 8	R 1/4	ASQ430F-02-08S-F20
	R 1/4	ASQ530F-02-08S-F20
	R 3/8	ASQ530F-03-08S-F20
Ø 10	R 1/4	ASQ430F-02-10S-F20
	R 1/4	ASQ530F-02-10S-F20
	R 3/8	ASQ530F-03-10S-F20
	R 3/8	ASQ630F-03-10S-F20
Ø 12	R 1/2	ASQ630F-04-10S-F20
	R 1/4	ASQ530F-02-12S-F20
	R 3/8	ASQ530F-03-12S-F20
	R 3/8	ASQ630F-03-12S-F20
	R 1/2	ASQ630F-04-12S-F20

Note) For dimensions and other details refer to specific catalogue of the series at www.smc.eu

Speed Controller with One-touch Fitting Related Equipment

Holder

TMH Series

A holder for securing a speed controller with One-touch fittings (In-line type)

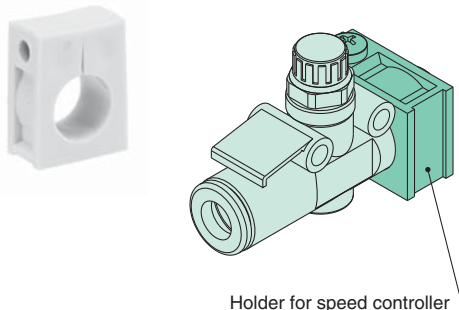

Holder for speed controller

In-line Speed Controllers and Holders

Tubing size	Applicable series					
	23	04	06	08	10	12
Body size	Ø 3.2	Ø 4	Ø 6	Ø 8	Ø 10	Ø 12
AS1002F	TMH-23J					
AS2002F		TMH-04J	TMH-06J			
AS2052F			TMH-06	TMH-08		
AS3002F			TMH-07		TMH-10	TMH-12
AS4002F						TMH-13

Residual Pressure Release Valve with One-touch Fitting

Series KE□

Residual pressure in the cylinder can be easily released with one push of the push button.

Residual Pressure Exhaust

With One-touch fitting without a push button guard

With One-touch fitting with a push button guard

Rc thread with a push button guard

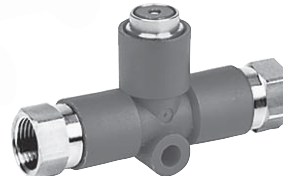

Symbol

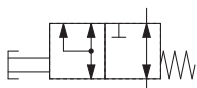

Applicable tubing O.D. [mm]	Model
Ø 6	KEA06
Ø 8	KEA08
Ø 10	KEA10
Ø 12	KEA12

Applicable tubing O.D. [mm]	Model
Ø 6	KEB06
Ø 8	KEB08
Ø 10	KEB10
Ø 12	KEB12

Connection thread	Model
Rc 1/4	KEC-02
Rc 3/8	KEC-03

Multi-holder

TMA Series

Can be used to secure the KE□ series exhaust valve with One-touch fitting.

One-touch fitting New KQ2, union tee, elbow, and straight can also be secured.



Model

Model	Stations	Applicable exhaust valve	Applicable One-touch fitting		
			Union tee	Union elbow	Straight union
TMA-04	10	—	KQ2T06-00A	KQ2L06-00A	KQ2H06-00A
TMA-06	8	KEA06	KQ2T08-00A	KQ2L08-00A	KQ2H08-00A
		KEB06			
TMA-08	8	KEA08	KQ2T10-00A	KQ2L10-00A	KQ2H10-00A
		KEB08			
		KEC-02			
TMA-10	6	KEA10	KQ2T12-00A	KQ2L12-00A	KQ2H12-00A
		KEB10			
TMA-12	6	KEA12	—	—	—
		KEB12			
		KEC-03			

Metering Valve with Silencer

RoHS **ASN2 Series**

Superior sound reducing performance

Over 20 dB at max. flow rate

Cylinder speed easily set

Shape of needle is the same as that of speed controller

Retainer prevents accidental loss of needle

<Example of mounting> Connection to the EXH port of the cylinder with valve

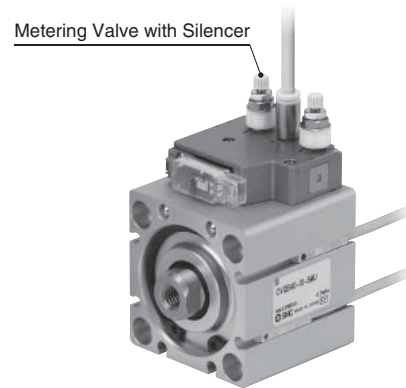

Symbol

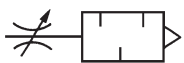

Model

Model	Port size
ASN2-M5	M5 x 0.8
ASN2-U10/32	10-32UNF
ASN2-01	1/8
ASN2-02	1/4
ASN2-03	3/8
ASN2-04	1/2

Quick Exhaust Valve with One-touch Fittings

RoHS **AQ□F Series**

Space-saving: Rectilinear IN-OUT tubing connections

Quick Exhaust

Symbol

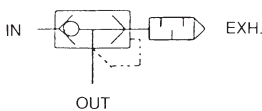

With silencer

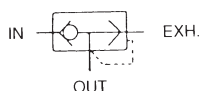

With exhaust port fitting

With silencer



Applicable tubing O.D. [mm]	Model
Ø 4	AQ240F-04-00
Ø 6	AQ240F-06-00
Ø 6	AQ340F-06-00

With exhaust port fitting



Applicable tubing O.D. [mm]	Model
Ø 4	AQ240F-04-04
Ø 6	AQ240F-06-06
Ø 6	AQ340F-06-06

Note) For dimensions and other details refer to specific catalogue of the series at www.smc.eu

Bushing Type Check Valve with One-touch Fittings

RoHS **AKH/AKB Series**

Drop Prevention

Straight type: **AKH**



Male connector type: **AKH**



Bushing type: **AKB**

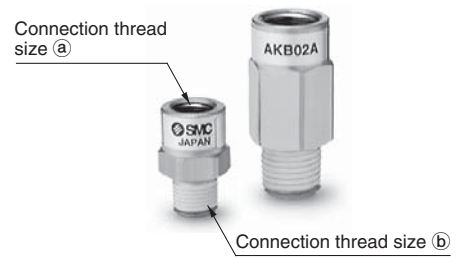

Applicable tubing O.D. [mm]	Model
Ø 4	AKH04-00
Ø 6	AKH06-00
Ø 8	AKH08-00
Ø 10	AKH10-00
Ø 12	AKH12-00

Applicable tubing O.D. [mm]	Connection thread	Model	
Ø 4	M5 x 0.8	AKH04A-M5	AKH04B-M5
	R 1/8	AKH04A-01S	AKH04B-01S
Ø 6	M5 x 0.8	AKH06A-M5	AKH06B-M5
	R 1/8	AKH06A-01S	AKH06B-01S
	R 1/4	AKH06A-02S	AKH06B-02S
Ø 8	R 1/8	AKH08A-01S	AKH08B-01S
	R 1/4	AKH08A-02S	AKH08B-02S
	R 3/8	AKH08A-03S	AKH08B-03S
Ø 10	R 1/4	AKH10A-02S	AKH10B-02S
	R 3/8	AKH10A-03S	AKH10B-03S
	R 1/2	AKH10A-04S	AKH10B-04S
Ø 12	R 3/8	AKH12A-03S	AKH12B-03S
	R 1/2	AKH12A-04S	AKH12B-04S

Connection thread size		Model	
①	②		
Rc 1/8	R 1/8	AKB01A-01S	AKB01B-01S
Rc 1/4	R 1/4	AKB02A-02S	AKB02B-02S
Rc 3/8	R 3/8	AKB03A-03S	AKB03B-03S
Rc 1/2	R 1/2	AKB04A-04S	AKB04B-04S

Note) For dimensions and other details refer to specific catalogue of the series at www.smc.eu

Check Valve

Made to Order

INA-14-290



INA-14-□



XTO-674-□□









Model	Port size	Specifications					Fluid	Operating temperature range [°C]	Minimum operating pressure [MPa]	Application
		Body Brass	All stainless steel	Low cracking pressure 0.01 MPa	Main parts: Stainless steel	Rubber material				
INA-14-290	Rc 1/8	●			●	NBR	Air / Water	-5 to 60	0.02	
INA-14-47-□	□: Port size 02: Rc 1/4 03: Rc 3/8 04: Rc 1/2		●			NBR	Air / Water	-5 to 60	0.05	Anti-corrosion
INA-14-85-□			●			FKM	Air / Water	-5 to 80	0.05	Anti-corrosion
XTO-674-□		●				NBR	Air	-5 to 60	0.05	Basic type
XTO-674-□A		●			●	NBR	Air / Water	-5 to 60	0.05	For water
XTO-674-□E		●			●	NBR	Air	-5 to 60	0.01	For vacuum, oscillation measures
XTO-674-□H		●				FKM	Air	-5 to 80	0.05	For high temperature
XTO-674-□L		●				CR	Air	-30 to 60	0.05	For low temperature
XTO-674-□AE		●			●	NBR	Air / Water	-5 to 60	0.01	
XTO-674-□AH		●			●	FKM	Air / Water	-5 to 80	0.05	
XTO-674-□AL		●			●	CR	Air	-30 to 60	0.05	
XTO-674-□EH		●			●	FKM	Air	-5 to 80	0.01	
XTO-674-□EL		●			●	CR	Air	-30 to 60	0.01	
XTO-674-□AEH		●			●	FKM	Air/Water	-5 to 80	0.01	
XTO-674-□AEL		●			●	CR	Air	-30 to 60	0.01	



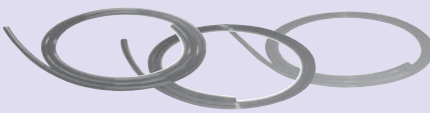









- AS
- AS-FS
- AS-1F
- AS-P
- AS-F
- AS-W2D
- AS-X737
- AS-2F
- AS-1F-3
- AS-DPP
- ASD
- Uni-AS
- Uni-AS-FS
- Uni-AS-1F
- AS-FE
- AS-FG
- AS-FSG
- AS-1FG
- ASD-FG
- ASG
- AS-FPQ/FPG
- AS-FM
- ASD-FM
- AS-F-D
- ASD-F-D
- AS-F-T
- ASD-F-T
- ASP
- ASV
- AS-R
- AS-Q
- Related

Tubing

Tubing





	Colour	Tubing O.D. [mm]						Applicable fluid: Temperature [°C]	Page
		Ø 2	Ø 4 (Ø 5/32")	Ø 6 (Ø 5/16")	Ø 8	Ø 10	Ø 12		
<p>General tubing 3.3 MPa max. at 20 °C*</p> <p>Nylon Tubing T Series</p> <p>*It varies according to each size.</p> 	Black White Red Blue Yellow Green							Air: -40 to 100 Water: 0 to 70	260
<p>Slightly flexible 2.0 MPa max. at 20 °C*</p> <p>Soft Nylon Tubing TS Series</p> <p>*It varies according to each size.</p> 	Black White Red Blue Yellow Green							Air: -40 to 100 Water: 0 to 50	263
<p>Flexible 0.8 MPa max. at 20 °C</p> <p>Polyurethane Tubing TU Series</p> 	Black White Red Blue Yellow Green Clear Orange Solid blue Clear blue Medium blue Brown Solid green Clear green Neon green Dark green Grey Light Grey Neon pink Solid purple Clear purple Solid red Clear red Silver Solid yellow Clear yellow Neon yellow Clear orange Neon orange							Air: -20 to 60 Water: 0 to 40	265
<p>Extremely flexible 0.6 MPa max. at 20 °C</p> <p>Soft Polyurethane Tubing TUS Series</p> 	Black White Red Blue Yellow Green Translucent Yellow brown							Air: -20 to 60	267
<p>0.8 MPa standard type, 1.0 MPa for high pressure type</p> <p>Hard Polyurethane Tubing TUH Series</p> 	Black White Blue Translucent							Air: -20 to 60	269
<p>Improved abrasion resistance</p> <p>Wear Resistant Tubing TUZ Series</p> 	Black White Red Blue Yellow Green							Air: -20 to 60	271
<p>For flexible and moving applications</p> <p>Polyurethane Coil Tubing TCU Series</p> 	1 core 2 cores 3 cores							Air: -20 to 60	273

Tubing

	Colour	Tubing O.D. [mm]											Applicable fluid: Temperature [°C]	Page		
		Ø 2	Ø 3	Ø 4 (Ø 5/32")	Ø 6	Ø 8 (Ø 5/16")	Ø 10	Ø 12	Ø 16	Ø 19	Ø 25					
Compact piping Polyurethane Flat Tubing TFU Series 	2 cores 3 cores														Air: -20 to 60	275
Multi-core, Multi Colour Specification Flat Tubing TU, TUS, TUZ Series 	Series TU 2 to 6 cores Series TUS 2 to 5 cores Series TUZ 2 to 6 cores														Air: -20 to 60	276
Use in spatter generating atmosphere/Flame resistant material FR Soft Nylon Tubing TRS Series Flame resistance (Equivalent to UL-94 standard V-0) 	Black White Red Blue Green														Air: -20 to 60 Water: 0 to 60	285
FR Double Layer Tubing TRB Series Flame resistance (Equivalent to UL-94 standard V-0) 	Black White Red Blue Yellow Green														Air: -20 to 60 Water: 0 to 60	287
FR Double Layer Polyurethane Tubing TRBU Series Flame resistance (Equivalent to UL-94 standard V-0) 	Black White Red Blue Yellow Green														Air: -20 to 60 Water: 0 to 40	289
FR Three-layer Polyurethane Tubing TRTU Series Flame resistance (Equivalent to UL-94 standard V-0) 	Black White Red Blue Yellow Green														Air: -20 to 60 Water: 0 to 40	291
2-Layer Soft Fluoropolymer Tubing TQ Series 	Translucent														Air: -20 to 100 Water: 0 to 70	293
For preventing static electricity Antistatic Tubing TA□ Series 	Black															295
Material: Super PFA Fluoropolymer Tubing TL/TIL Series 	Translucent														Refer to the applicable fluid in page 282.: 260	297
Material: PFA Fluoropolymer Tubing (PFA) TLM/TILM Series 	Translucent Red (Translucent) Blue (Translucent) Black (Opaque)														Air, Water (DI water (Pure water)), Inert gas: 260	299 301
Compatible with the Food Sanitation Law and dissolution test approved by FDA FEP Tubing (Fluoropolymer) TH/TH Series 	Translucent Red (Translucent) Blue (Translucent) Black (Opaque)														Air, Inert gas: -20 to 200 Water: 0 to 100	303
Compatible with the Food Sanitation Law and dissolution test approved by FDA Soft Fluoropolymer Tubing (Modified PTFE) TD/TID Series 	Translucent														Air, Water Inert gas: 260	305

T
TS
TU
TUS
TUH
TUZ
TCU
TFU
TU/TUS TUZ
IDK
TRS
TRB
TRBU
TRTU
TQ
TAS
TAU
TL/ TIL
TLM/ TILM
TH/ THI
TD/ TID
TPH
TPS
Related

Clean Series Tubing





	Colour	Tubing O.D. [mm]							Applicable fluid: Temperature [°C]	Page	
		Ø 2 (Ø 5/32")	Ø 4	Ø 6 (Ø 5/16")	Ø 8	Ø 10	Ø 12	Ø 16			Ø 19
Flexible tubing 0.8 MPa max. (at 20 °C) Polyurethane Tubing 10-TU Series 	Black White Red Blue Yellow Green Clear Orange	•	•	•	•	•	•			266	
For flexible and moving applications Polyurethane Coil Tubing 10-TCU Series 	1 core 2 cores 3 cores	•	•	•					273		
Compact piping Polyurethane Flat Tubing 10-TFU Series 	2 cores 3 cores	•	•	•							275
Blow system and air system for drive in clean room Polyolefin Tubing TPH Series 	Black White Red Blue Yellow Green	•	•	•	•	•	•				
Soft Polyolefin Tubing TPS Series 		•	•	•	•	•	•		309		

Air, Nitrogen gas: -20 to 80

Water (DI water (Pure water)): 5 to 80

Note) For details, refer to the **WEB catalogue** on www.smc.eu

Related Products

	Colour	Tubing O.D. [mm]							Page	
		Ø 2 (Ø 5/32")	Ø 4	Ø 6 (Ø 5/16")	Ø 8	Ø 10	Ø 12	Ø 16		Ø 19
The outer layer for double layer tubing, Series TRB, TRBU is peeled off easily. Double Layer Tube Stripper TKS Series 	Orange Yellow Blue Green			•						288
Multi-tube Holder TM Series 		•	•	•	•	•			311	
Tube Cutter TK Series 		•	•	•	•	•	•			311
Tube Releasing Tool TG Series 		•	•	•	•	•	•		312	
Tube Stand & Tube Reel TB/TBR Series 		•	•	•	•	•	•			312

T Series

■ Tubing size: Metric Size

How to Order



T0425 B - 20

Tubing model

Length per roll

Symbol	Length
20	20 m roll
100	100 m roll (Black and white only)

Colour

Symbol	Colour
B	Black (Opaque)
W	White (Material Colour)
R	Red (Opaque)
BU	Blue (Opaque)
Y	Yellow (Opaque)
G	Green (Opaque)

Max. Operating Pressure

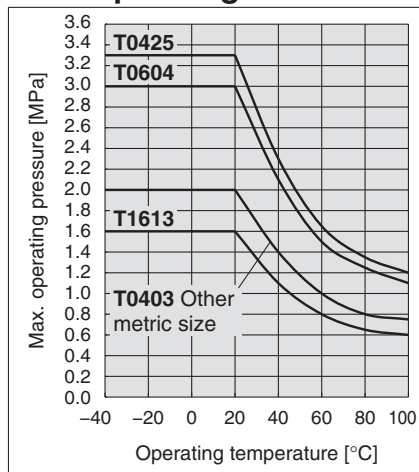

Model

● -20 m roll □ -100 m roll (T1613 is reel.)

Model	Tubing size							
	Metric size (Series T)							
	T0425	T0403	T0604	T0645	T0806	T1075	T1209	T1613
Tubing O.D. [mm]	4	4	6	6	8	10	12	16
Tubing I.D. [mm]	2.5	3	4	4.5	6	7.5	9	13
Black (B)	●	●	●	●	●	●	●	●
White (W)	●	●	●	●	●	●	●	●
Red (R)	●		●		●	●	●	●
Blue (BU)	●		●		●	●	●	●
Yellow (Y)	●		●		●	●	●	●
Green (G)	●		●		●	●	●	●

Specifications

Fluid		Air / Water							
Max. operating pressure [MPa]	20 °C or less	3.3	2.0	3.0	2.0	2.0	2.0	2.0	1.6
	40 °C	2.3	1.4	2.1	1.4	1.4	1.4	1.4	1.1
	60 °C	1.65	1.0	1.5	1.0	1.0	1.0	1.0	0.8
	80 °C	1.35	0.8	1.25	0.8	0.8	0.8	0.8	0.65
	100 °C	1.2	0.75	1.1	0.75	0.75	0.75	0.75	0.6
Applicable fittings		One-touch fittings, Insert fittings, Self-align fittings, Miniature fittings							
Min. bending radius [mm]	Min. bending radius	13	20	24	30	40	50	60	100
	Tube close bend radius (Reference)	10	15	18	23	30	40	45	75
Operating temperature		-40 to +100 °C, Water: 0 to +70 °C (No freezing)							
Material		Nylon 12							

- Note 1) Be sure to operate under the maximum operating pressure and operating temperature conditions using the lower specifications of either the tubing or fittings.
- Note 2) Mount an inner sleeve when using metal One-touch fittings in high-temperature environments of 60 °C or more. Use self-align fittings at a temperature of 60 °C or less.
- Note 3) The minimum bending radius is the representative value measured as shown in the right figure.
- Use a tube above the recommended minimum bending radius.
 - The tubing may be bent if used under the recommended minimum bending radius. Therefore, refer to the tube close bend radius and make sure that the tubing is not bent or flattened.
 - Please note that the tube close bend radius is not warranted because of the value when 2R is measured by the method in the next page if the tubing is bent or flattened, etc.

- T
- TS
- TU
- TUS
- TUH
- TUZ
- TCU
- TFU
- TU/TUS
- TUZ
- IDK
- TRS
- TRB
- TRBU
- TRTU
- TQ
- TAS
- TAU
- TL/TIL
- TLM/TILM
- TH/TIH
- TD/TID
- TPH
- TPS
- Related

Length per roll **20** m roll

O.D.	I.D.	Colour (Symbol)	Model
Ø 4	Ø 2.5	Black (B)	T0425 [Colour symbol] -20
		White (W)	
		Red (R)	
		Blue (BU)	
		Yellow (Y)	
Ø 4	Ø 3	Black (B)	T0403 [Colour symbol] -20
		White (W)	
Ø 6	Ø 4	Black (B)	T0604 [Colour symbol] -20
		White (W)	
		Red (R)	
		Blue (BU)	
		Yellow (Y)	
	Green (G)		
	Ø 6	Ø 4.5	Black (B)
White (W)			
Ø 8	Ø 6	Black (B)	T0806 [Colour symbol] -20
		White (W)	
		Red (R)	
		Blue (BU)	
		Yellow (Y)	
Ø 10	Ø 7.5	Black (B)	T1075 [Colour symbol] -20
		White (W)	
		Red (R)	
		Blue (BU)	
		Yellow (Y)	
Ø 12	Ø 9	Black (B)	T1209 [Colour symbol] -20
		White (W)	
		Red (R)	
		Blue (BU)	
		Yellow (Y)	
Ø 16	Ø 13	Black (B)	T1613 [Colour symbol] -20
		White (W)	

Length per roll **100** m roll

O.D.	I.D.	Model
Ø 4	Ø 2.5	T0425 [Colour symbol] -100
Ø 6	Ø 4	T0604 [Colour symbol] -100
	Ø 4.5	T0645 [Colour symbol] -100 ^{Note 1)}
Ø 8	Ø 6	T0806 [Colour symbol] -100
Ø 10	Ø 7.5	T1075 [Colour symbol] -100
Ø 12	Ø 9	T1209 [Colour symbol] -100
Ø 16	Ø 13	T1613 [Colour symbol] -100 ^{Note 2) Note 3)}

[Colour symbol] -B: Black, W: White, R: Red, BU: Blue, Y: Yellow, G: Green
 Nota 1) -B: Black
 Nota 2) -B: Black, W: White
 Nota 3) T1613 is reel.



Made to Order

1 Reel **X3**

O.D.	I.D.	Model	Length per roll [m]
Ø 4	Ø 2.5	T0425 [Colour symbol] -100-X3	100
		T0425 [Colour symbol] -500-X3	500
Ø 6	Ø 4	T0604 [Colour symbol] -100-X3	100
		T0604 [Colour symbol] -500-X3	500
Ø 8	Ø 6	T0806 [Colour symbol] -100-X3	100
		T0806 [Colour symbol] -200-X3	200
Ø 10	Ø 7.5	T1075 [Colour symbol] -100-X3	100
		T1075 [Colour symbol] -150-X3	150
Ø 12	Ø 9	T1209 [Colour symbol] -100-X3	100

[Colour symbol] -B: Black, W: White, R: Red, BU: Blue, Y: Yellow, G: Green

2 Reinforced Corrugated Cardboard Specification Longer Length Reel **X64**

O.D.	I.D.	Model	Length per roll [m]
Ø 6	Ø 4	T0604 [Colour symbol] -250-X64	250
		T0604 [Colour symbol] -500-X64	500

[Colour symbol] -B: Black, W: White

⚠ Precautions

Be sure to read this before handling.
Refer to page 327 for Safety Instructions and pages 329 to 332 for Fittings and Tubing Precautions.

⚠ Caution

1. Applicable for general industrial water. Please consult with SMC if using for the other kind of fluid. Also, the surge pressure must not exceed the maximum operating pressure. If the surge pressure exceeds the maximum operating pressure, it will result in damage to fittings and tubes.
2. Please exercise caution when using this item in a clean room. There is a possibility of plasticizer and other materials precipitating on the tube surface and detracting from the cleanliness level of the room.

How to measure the minimum bending radius.

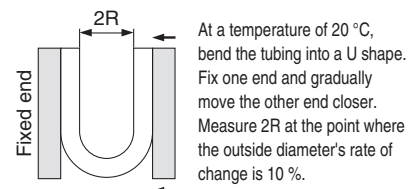

Nylon Tubing with Printed Number

T□□-100-□-X190 Series

■ Identification number (1 to 99) printed on the tube

Please contact SMC for availability

Tubing O.D. x I.D.: $\varnothing 6 \times \varnothing 4, \varnothing 8 \times \varnothing 6$

This prevents piping mistakes when there are many pipes and the tubes are long.

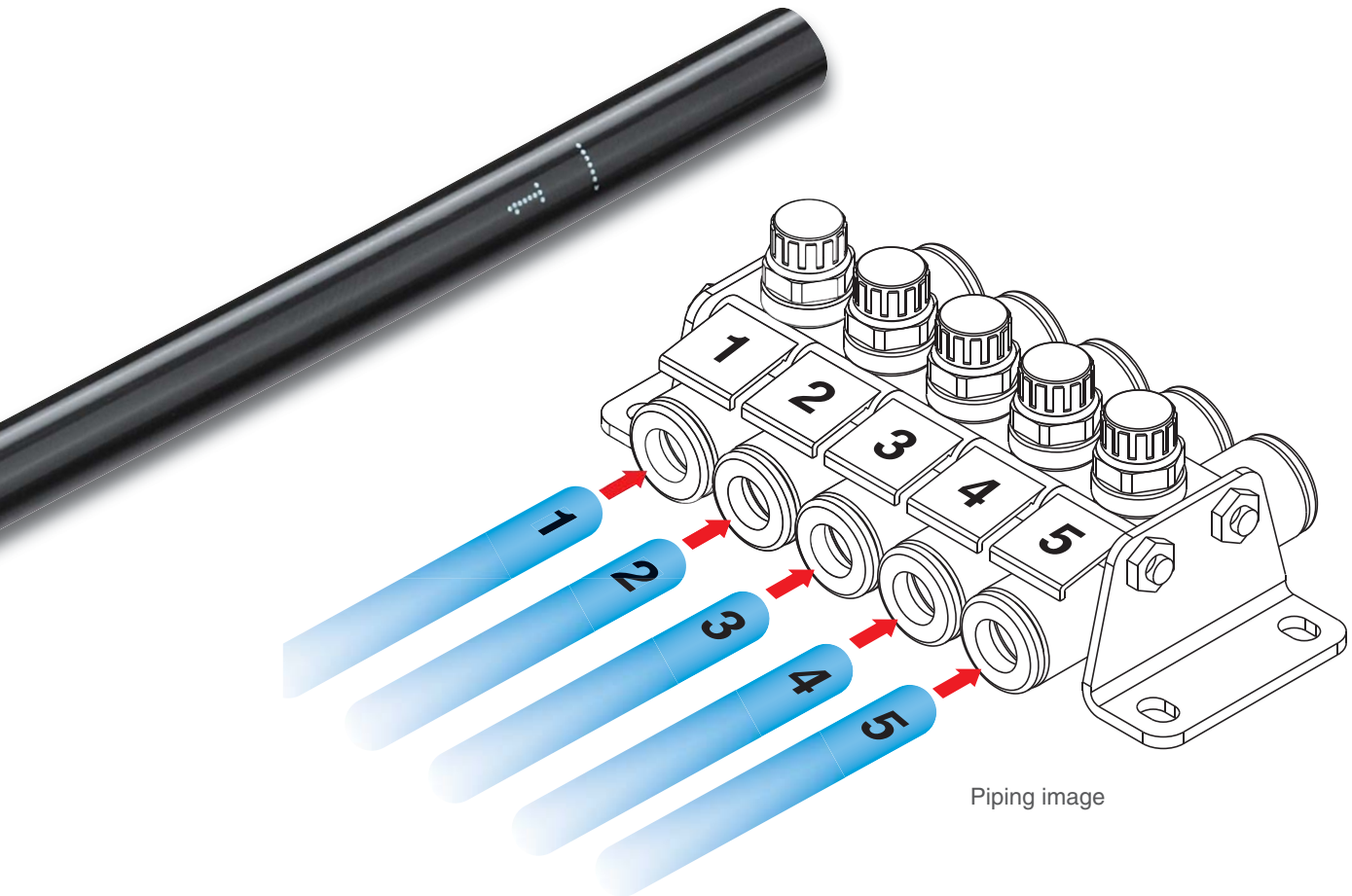

Available numbers: 1 to 99

Direction and clearance of letters can be changed. Letters can also be printed. Please inquire with us for details.

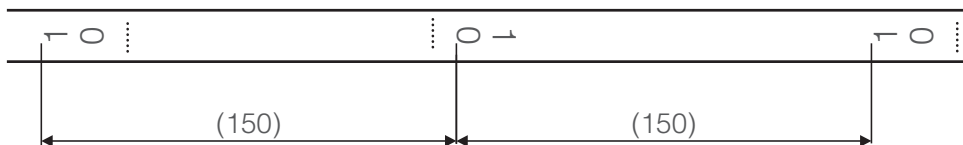

Tubing O.D. x I.D.	$\varnothing 6 \times \varnothing 4, \varnothing 8 \times \varnothing 6$
Colour	Black (Translucent), White (Material colour), Red (Translucent), Blue (Translucent), Yellow (Translucent), Green (Translucent)
Length	100 m roll

- T
- TS
- TU
- TUS
- TUH
- TUZ
- TCU
- TFU
- TU/TUS
TUZ
- IDK
- TRS
- TRB
- TRBU
- TRTU
- TQ
- TAS
- TAU
- TL/
TIL
- TLM/
TILM
- TH/
TIH
- TD/
TID
- TPH
- TPS
- Related

■ Tubing size: Metric Size

Slightly flexible tubing



How to Order

TS0604 W - 100

Tubing model

Colour

Symbol	Colour
B	Black (Opaque)
W	White (Material Colour)
R	Red (Opaque)
BU	Blue (Opaque)
Y	Yellow (Opaque)
G	Green (Opaque)

Length per roll

Symbol	Length
20	20 m roll
100	100 m roll (Black and white only)

Max. Operating Pressure

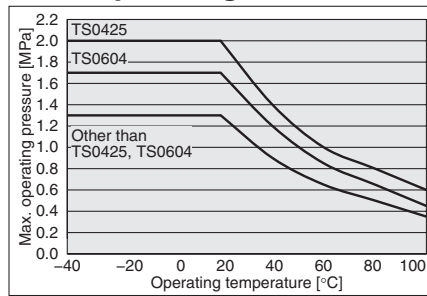

Model

● - 20 m roll □ - 100 m roll (TS1612 is reel.)

Model	Tubing size					
	Metric size					
	TS0425	TS0604	TS0806	TS1075	TS1209	TS1612
Tubing O.D. [mm]	4	6	8	10	12	16
Tubing I.D. [mm]	2.5	4	6	7.5	9	12
Black (B)	●	□	●	●	●	●
White (W)	●	□	●	●	●	●
Red (R)	●	●	●	●	●	●
Blue (BU)	●	●	●	●	●	●
Yellow (Y)	●	●	●	●	●	●
Green (G)	●	●	●	●	●	●

Specifications

Fluid		Air / Water ^{Note 1)}					
Max. operating pressure [MPa] ^{Note 2)}	20 °C or less	2.0	1.7	1.3	1.3	1.3	1.3
	40 °C	1.4	1.2	0.9	0.9	0.9	0.9
	60 °C	1.0	0.85	0.65	0.65	0.65	0.65
	80 °C	0.8	0.65	0.5	0.5	0.5	0.5
	100 °C	0.6	0.45	0.35	0.35	0.35	0.4
Applicable fittings ^{Note 2)} ^{Note 3)}		One-touch fittings, Insert fittings, Self-align fittings, Miniature fittings					
Min. bending radius [mm] ^{Note 4)}	Min. bending radius	15	23	45	55	65	90
	Tube close bend radius (Reference)	12	17	34	42	50	70
Operating temperature ^{Note 2)}		-40 to +100 °C, Water: 0 to +50 °C (No freezing)					
Material		Nylon 12					

Note 1) Refer to the "Printing/Fluid".

Note 2) Be sure to operate under the maximum operating pressure and operating temperature conditions using the lower specifications of either the tubing or fittings.

Note 3) Mount an inner sleeve when using metal One-touch fittings in high-temperature environments of 60 °C or more. Use self-align fittings at a temperature of 60 °C or less.

Note 4) The minimum bending radius is the representative value measured as shown in the right figure.

- Use a tube above the recommended minimum bending radius.
- The tubing may be bent if used under the recommended minimum bending radius. Therefore, refer to the tube close bend radius and make sure that the tubing is not bent or flattened.
- Please note that the tube close bend radius is not warranted because of the value when 2R is measured by the method in the next page if the tubing is bent or flattened, etc.

Printing/Fluid

Print code		Fluid
Previous	SMC TS 0604 SOFTNYLON 6 x 4	Air
NEW	● SMC TS 0604 SOFTNYLON 6 x 4	Air / Water

Length per roll **20** m roll

O.D.	I.D.	Colour (Symbol)	Model
Ø 4	Ø 2.5	Black (B)	TS0425 [Colour symbol] -20
		White (W)	
		Red (R)	
		Blue (BU)	
		Yellow (Y)	
Ø 6	Ø 4	Black (B)	TS0604 [Colour symbol] -20
		White (W)	
		Red (R)	
		Blue (BU)	
		Yellow (Y)	
Ø 8	Ø 6	Black (B)	TS0806 [Colour symbol] -20
		White (W)	
		Red (R)	
		Blue (BU)	
		Yellow (Y)	
Ø 10	Ø 7.5	Black (B)	TS1075 [Colour symbol] -20
		White (W)	
		Red (R)	
		Blue (BU)	
		Yellow (Y)	
Ø 12	Ø 9	Black (B)	TS1209 [Colour symbol] -20
		White (W)	
		Red (R)	
		Blue (BU)	
		Yellow (Y)	
Ø 16	Ø 12	Black (B)	TS1612 [Colour symbol] -20
		White (W)	

Length per roll **100** m roll

O.D.	I.D.	Colour (Symbol)	Model
Ø 4	Ø 2.5	Black (B)	TS0425 [Colour symbol] -100
		White (W)	
Ø 6	Ø 4	Black (B)	TS0604 [Colour symbol] -100
		White (W)	
Ø 8	Ø 6	Black (B)	TS0806 [Colour symbol] -100
		White (W)	
Ø 10	Ø 7.5	Black (B)	TS1075 [Colour symbol] -100
		White (W)	
Ø 12	Ø 9	Black (B)	TS1209 [Colour symbol] -100
		White (W)	
Ø 16	Ø 12	Black (B)	TS1612 [Colour symbol] -100
		White (W)	

* TS1612 is reel.



Made to Order

1 Reel **X3**

O.D.	I.D.	Model	Length per roll
Ø 4	Ø 2.5	TS0425 [Colour symbol] -100-X3	100
		TS0425 [Colour symbol] -500-X3	500
Ø 6	Ø 4	TS0604 [Colour symbol] -100-X3	100
		TS0604 [Colour symbol] -500-X3	500
Ø 8	Ø 6	TS0806 [Colour symbol] -100-X3	100
		TS0806 [Colour symbol] -200-X3	200
Ø 10	Ø 7.5	TS1075 [Colour symbol] -100-X3	100
		TS1075 [Colour symbol] -150-X3	150
Ø 12	Ø 9	TS1209 [Colour symbol] -100-X3	100

[Colour symbol]-B: Black, W: White, R: Red, BU: Blue, Y: Yellow, G: Green

⚠ Precautions

Be sure to read this before handling.
Refer to page 327 for Safety Instructions and pages 329 to 332 for Fittings and Tubing Precautions.

⚠ Caution

- Compatible with water due to a change in materials. Compatible fluid types are printed on the tube body for differentiation, so please be sure to check this. (Note) If using the previous TS/TISA series with "water", the tube may shrink and cause air leakage or the tube may fall out.
- The products which changed the material are applicable for general industrial water. Please contact SMC if using other kinds of fluid.
Surge pressure must be under the max. operating pressure. If the surge pressure exceeds the maximum operating pressure, it will result in damage to fittings and tubes.
- Please exercise caution when using this item in a clean room. There is a possibility of plasticizer and other materials precipitating on the tube surface and detracting from the cleanliness level of the room.

How to measure the minimum bending radius.

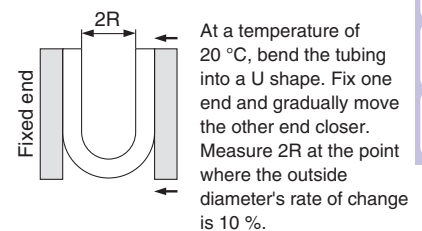

- T
- TS
- TU
- TUS
- TUH
- TUZ
- TCU
- TFU
- TU/TUS
- TUZ
- IDK
- TRS
- TRB
- TRBU
- TRTU
- TQ
- TAS
- TAU
- TL/TIL
- TLM/TILM
- TH/TIH
- TD/TID
- TPH
- TPS
- Related

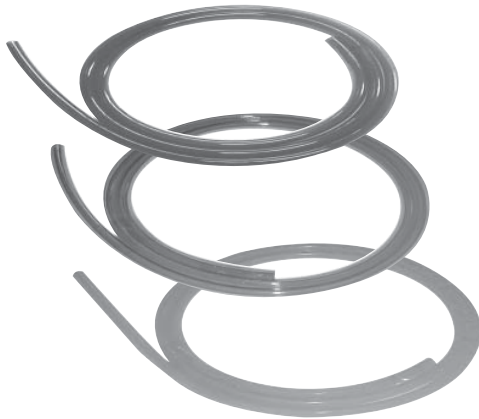

How to Order

TU0425 BU - 20

Tubing model

● Length per roll

Symbol	Length
20	20 m roll
100	100 m roll

● Colour

Symbol	Colour	Symbol	Colour	Symbol	Colour
B	Black	BU1	Solid blue	P1	Neon pink
W	White	BU2	Clear blue	PU2	Solid purple
R	Red	BU3	Medium blue	PU1	Clear purple
BU	Blue	BR1	Brown	R1	Solid red
Y	Yellow	G1	Solid green	R2	Clear red
G	Green	G2	Clear green	S1	Silver
C	Clear	G3	Neon green	Y1	Solid yellow
YR	Orange	G4	Dark green	Y2	Clear yellow
		GR1	Grey	Y3	Neon yellow
		GR2	Light Grey	YR1	Clear orange
				YR2	Neon orange

Burst Pressure Characteristics Curve and Operating Pressure

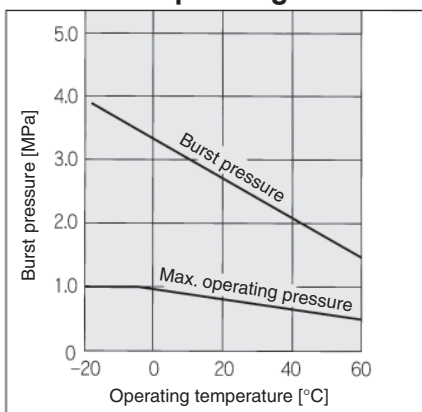

Specifications

Model	TU0212	TU0425	TU0604	TU0805	TU1065	TU1208	TU1610
Fluid	Air / Water						
Max. operating pressure (at 20 °C)	0.8 MPa						
Burst pressure	Refer to the burst pressure characteristics curve.						
Applicable fittings	One-touch fittings, Insert fittings, Miniature fittings						
Min. bending radius	4	10	15	20	27	35	45
Operating temperature	-20 to +60 °C, Water: 0 to +40 °C (No freezing)						
Material	Polyurethane						

⚠ Precautions

Be sure to read this before handling.

Refer to page 327 for Safety Instructions and pages 329 to 332 for Fittings and Tubing Precautions.

⚠ Caution

- Applicable for general industrial water. Please consult with SMC if using for the other kind of fluid. Also, the surge pressure must not exceed the maximum operating pressure. If the surge pressure exceeds the maximum operating pressure, it will result in damage to fittings and tubes.
- The value of the max. operating pressure is at a temperature of 20 °C. Refer to the burst pressure characteristics curve for other temperatures. Furthermore, abnormal temperature rise caused by adiabatic compression may result in the tube bursting.
- The value of the minimum bending radius is measured at the temperature of 20 °C as shown in the right figure.

How to measure the minimum bending radius.

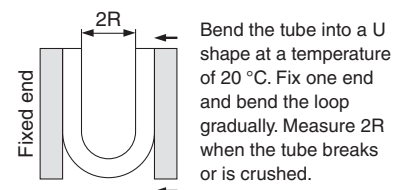

● - 20 m roll □ - 100 m roll (TU1610 is reel.) ■ - Manufactured upon receipt of order (Please consult with SMC.)

Model	Tubing size						
	Metric size						
	TU0212	TU0425	TU0604	TU0805	TU1065	TU1208	TU1610
O.D. [mm]	2	4	6	8	10	12	16
I.D. [mm]	1.2	2.5	4	5	6.5	8	10
Black (B)	●	●	●	●	●	●	●
White (W)	●	●	●	●	●	●	●
Red (R)	●	●	●	●	●	●	■
Blue (BU)	●	●	●	●	●	●	●
Yellow (Y)	●	●	●	●	●	●	■
Green (G)	●	●	●	●	●	●	■
Clear (C)	●	●	●	●	●	●	●
Orange (YR)	■	●	●	●	●	●	■
Solid blue (BU1)	■	●	●	●	●	●	■
Clear blue (BU2)	■	●	●	●	●	●	■
Medium blue (BU3)	■	●	●	●	●	●	■
Brown (BR1)	■	●	●	●	●	●	■
Solid green (G1)	■	●	●	●	●	●	■
Clear green (G2)	■	●	●	●	●	●	■
Neon green (G3)	■	●	●	●	●	●	■
Dark green (G4)	■	●	●	●	●	●	■
Grey (GR1)	■	●	●	●	●	●	■
Light Grey (GR2)	■	●	●	●	●	●	■
Neon pink (P1)	■	●	●	●	●	●	■
Solid purple (PU1)	■	●	●	●	●	●	■
Clear purple (PU2)	■	●	●	●	●	●	■
Solid red (R1)	■	●	●	●	●	●	■
Clear red (R2)	■	●	●	●	●	●	■
Silver (S1)	■	●	●	●	●	●	■
Solid yellow (Y1)	■	●	●	●	●	●	■
Clear yellow (Y2)	■	●	●	●	●	●	■
Neon yellow (Y3)	■	●	●	●	●	●	■
Clear orange (YR1)	■	●	●	●	●	●	■
Neon orange (YR2)	■	●	●	●	●	●	■

- T
- TS
- TU
- TUS
- TUH
- TUZ
- TCU
- TFU
- TU/TUS
- TUZ
- IDK
- TRS
- TRB
- TRBU
- TRTU
- TQ
- TAS
- TAU
- TL/TIL
- TLM/TILM
- TH/THH
- TD/TID
- TPH
- TPS
- Related



Made to Order

1 Reel X3

O.D.	I.D.	Model	Length per roll [m]
Ø 4	Ø 2.5	TU0425 [Colour symbol]-100-X3	100
		TU0425 [Colour symbol]-500-X3	500
Ø 6	Ø 4	TU0604 [Colour symbol]-100-X3	100
		TU0604 [Colour symbol]-400-X3	400
Ø 8	Ø 5	TU0805 [Colour symbol]-100-X3	100
		TU0805 [Colour symbol]-200-X3	200
Ø 10	Ø 6.5	TU1065 [Colour symbol]-100-X3	100
Ø 12	Ø 8	TU1208 [Colour symbol]-100-X3	100

[Colour symbol]-B: Black, W: White, R: Red, BU: Blue, Y: Yellow, G: Green, C: Clear, YR: Orange

2 Clean Series 10-

O.D.	I.D.	Model
Ø 2	Ø 1.2	10-TU0212 [Colour symbol]-20
Ø 4	Ø 2.5	10-TU0425 [Colour symbol]-20
Ø 6	Ø 4	10-TU0604 [Colour symbol]-20
Ø 8	Ø 5	10-TU0805 [Colour symbol]-20
Ø 10	Ø 6.5	10-TU1065 [Colour symbol]-20
Ø 12	Ø 8	10-TU1208 [Colour symbol]-20

[Colour symbol]-B: Black, W: White, R: Red, BU: Blue, Y: Yellow, G: Green, C: Clear, YR: Orange. Except Ø 2 for YR (orange)

3 Compatible with Food Sanitation Law X217

O.D.	I.D.	Model
Ø 4	Ø 2.5	TU0425 [Colour symbol]-20-X217
Ø 6	Ø 4	TU0604 [Colour symbol]-20-X217
Ø 8	Ø 5	TU0805 [Colour symbol]-20-X217
Ø 10	Ø 6.5	TU1065 [Colour symbol]-20-X217
Ø 12	Ø 8	TU1208 [Colour symbol]-20-X217

[Colour symbol]-B: Black, W: White, BU: Blue, C: Clear

* Note that the model number is not printed on the tube body.

Soft Polyurethane Tubing

RoHS

TUS Series

■ Tubing size: Metric Size

Extremely flexible



Burst Pressure Characteristics Curve and Operating Pressure

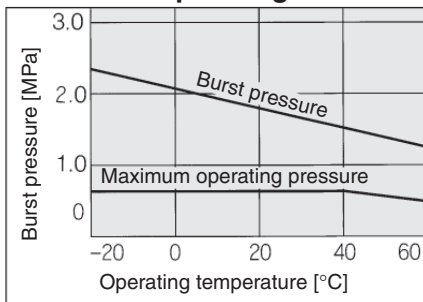

TUS related accessories

Inner sleeve

TJ Series

Reinforces soft polyurethane tubing. Insert an inner sleeve into soft polyurethane tubing when used with a One-touch fitting.

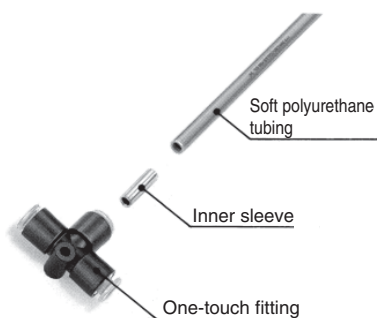

Model

Model	Applicable tubing model	Length [mm]
TJ-0425	TUS0425	18
TJ-0604	TUS0604	19
TJ-0805	TUS0805	20.5
TJ-1065	TUS1065	23
TJ-1208	TUS1208	24

How to Order

TUS1065 B - 100

Tubing model

Length per roll

Symbol	Length
20	20 m roll
100	100 m reel (Black and blue only)

Colour

Symbol	Colour
B	Black
W	White
R	Red
BU	Blue
Y	Yellow
G	Green
N	Translucent
YB	Yellow brown

Model

● -20 m roll □ -100 m reel

Model	Tubing size				
	Metric size				
	TUS0425	TUS0604	TUS0805	TUS1065	TUS1208
Tubing O.D. [mm]	4	6	8	10	12
Tubing I.D. [mm]	2.5	4	5	6.5	8
Black (B)	●	□	●	□	●
White (W)	●	●	●	●	●
Red (R)	●	●	●	●	●
Blue (BU)	●	□	●	□	●
Yellow (Y)	●	●	●	●	●
Green (G)	●	●	●	●	●
Translucent (N) ^{Note 1)}	●	●	●	●	●
Yellow brown (YB)	●	●	●	●	●

Specifications

Fluid	Air					
Max. operating pressure (at 20 °C)	0.6 MPa					
Burst pressure	Refer to the burst pressure characteristics curve.					
Applicable fittings	^{Note 3)} One-touch fittings, Insert fittings, Hose nipple					
Min. bending radius [mm] ^{Note 2)}	8	15	15	22	29	
Operating temperature	-20 to +60 °C (No freezing)					
Material	Polyurethane					
Tube drawing strength [N] (Using One-touch fitting)	Without inner sleeve	15	60	60	85	110
	With inner sleeve	80	230	250	300	480

Note 1) Not clear, but translucent due to material.

Note 2) Min. bending radius is measured as shown in the next page.

Note 3) Always use inner sleeve (Series TJ) in safety circuit or critical area.

Length per roll **20** m roll

O.D.	I.D.	Colour (Symbol)	Model
Ø 4	Ø 2.5	Black (B)	TUS0425 [Colour symbol]-20
		White (W)	
		Red (R)	
		Blue (BU)	
		Yellow (Y)	
		Green (G)	
		Translucent (N) ^{Note)}	
		Yellow brown (YB)	
Ø 6	Ø 4	Black (B)	TUS0604 [Colour symbol]-20
		White (W)	
		Red (R)	
		Blue (BU)	
		Yellow (Y)	
		Green (G)	
		Translucent (N) ^{Note)}	
		Yellow brown (YB)	
Ø 8	Ø 5	Black (B)	TUS0805 [Colour symbol]-20
		White (W)	
		Red (R)	
		Blue (BU)	
		Yellow (Y)	
		Green (G)	
		Translucent (N) ^{Note)}	
		Yellow brown (YB)	
Ø 10	Ø 6.5	Black (B)	TUS1065 [Colour symbol]-20
		White (W)	
		Red (R)	
		Blue (BU)	
		Yellow (Y)	
		Green (G)	
		Translucent (N) ^{Note)}	
		Yellow brown (YB)	
Ø 12	Ø 8	Black (B)	TUS1208 [Colour symbol]-20
		White (W)	
		Red (R)	
		Blue (BU)	
		Yellow (Y)	
		Green (G)	
		Translucent (N) ^{Note)}	
		Yellow brown (YB)	

Note) Not clear, but translucent due to material.

Length per roll **100** m reel

O.D.	I.D.	Colour (Symbol)	Model
Ø 4	Ø 2.5	Black (B)	TUS0425 [Colour symbol]-100
		Blue (BU)	
Ø 6	Ø 4	Black (B)	TUS0604 [Colour symbol]-100
		Blue (BU)	
Ø 8	Ø 5	Black (B)	TUS0805 [Colour symbol]-100
		Blue (BU)	
Ø 10	Ø 6.5	Black (B)	TUS1065 [Colour symbol]-100
		Blue (BU)	
Ø 12	Ø 8	Black (B)	TUS1208 [Colour symbol]-100
		Blue (BU)	

- T
- TS
- TU
- TUS**
- TUH
- TUZ
- TCU
- TFU
- TU/TUS
- TUZ
- IDK
- TRS
- TRB
- TRBU
- TRTU
- TQ
- TAS
- TAU
- TL/TIL
- TLM/TILM
- TH/THI
- TD/TID
- TPH
- TPS
- Related

⚠ Precautions

Be sure to read this before handling.
Refer to page 327 for Safety Instructions and pages 329 to 332 for Fittings and Tubing Precautions.

⚠ Caution

1. Use a nylon or polyurethane tubing for general industrial water, otherwise the tube may result in being fallen out or bursted when the max. operating pressure is lower and the surge pressure is occurred.
2. The value of the max. operating pressure is at a temperature of 20 °C. Refer to the burst pressure characteristics curve for other temperatures.
Furthermore, abnormal temperature rise caused by adiabatic compression may result in the tube bursting.
3. The value of the minimum bending radius is measured at the temperature of 20 °C as shown in the right figure.
4. Use inner sleeve, taking the removing force into consideration when used with One-touch fittings.

How to measure the minimum bending radius.

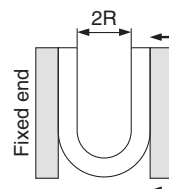

Bend the tube into a U shape at a temperature of 20 °C. Fix one end and bend the loop gradually. Measure 2R when the tube breaks or is crushed.

Hard Polyurethane Tubing

RoHS

TUH Series

■ Tubing size: Metric Size

Standard type



Effective area is improved up to approx. 44 %.
TUH/Standard type

(When compared to the polyurethane tubing TU0805 (O.D.: 8 mm, Length: 1 m))

High pressure type



Operating pressure: 1 MPa (at 20 °C)
TUH/High pressure type

Bending radius equivalent to the polyurethane tubing TU series at the same operating pressure as soft nylon tubing TS series

Burst Pressure Characteristics Curve and Operating Pressure

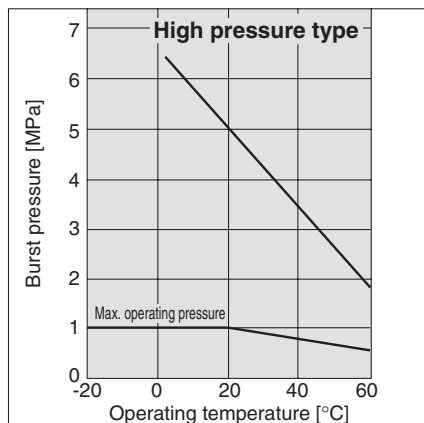
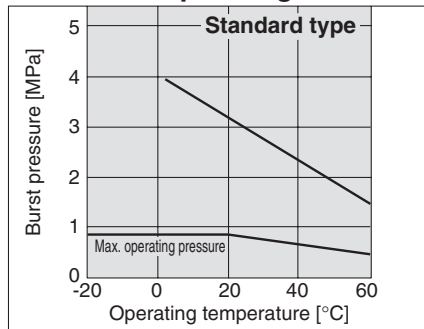

How to Order

Standard type **TUH0644 B - 20**

High pressure type **TUH0604 B - 20**

Tubing model

Length per roll

Colour

Symbol	Colour
B	Black
W	White
BU	Blue
N	Translucent

Symbol	Length
20	20 m roll
100	100 m roll

Model

● - 20 m roll □ - 100 m roll

Size	Tubing size					
	Metric size					
	Model	TUH0428	TUH0644	TUH0858	TUH1073	TUH1288
Standard type	O.D. [mm]	4	6	8	10	12
	I.D. [mm]	2.8	4.4	5.8	7.3	8.8
High pressure type	Model	TUH0425	TUH0604	TUH0805	TUH1065	TUH1208
	O.D. [mm]	4	6	8	10	12
	I.D. [mm]	2.5	4	5	6.5	8

Black (B)	●	●	●	●	●
White (W)	□	□	□	□	□
Blue (BU)	●	●	●	●	●
Translucent (N)	□	□	□	□	□

Specifications

Fluid	Air					
Max. operating pressure (at 20 °C)	Standard type	0.8 MPa				
	High pressure type	1 MPa				
Applicable fittings	Standard type	One-touch fittings				
	High pressure type	One-touch fittings, Insert fittings, Miniature fittings				
Min. bending radius [mm]	Standard type	10	18	24	30	36
	High pressure type	10	15	20	27	35
Burst pressure	Refer to the burst pressure characteristics curve.					
Operating temperature	-20 to 60 °C (No freezing)					
Material	Polyurethane					

Length per roll **20** m roll

Standard Type

O.D.	I.D.	Colour (Symbol)	Model
Ø 4	Ø 2.8	Black (B)	TUH0428 Colour symbol -20
		White (W)	
		Blue (BU)	
		Translucent (N)	
Ø 6	Ø 4.4	Black (B)	TUH0644 Colour symbol -20
		White (W)	
		Blue (BU)	
		Translucent (N)	
Ø 8	Ø 5.8	Black (B)	TUH0858 Colour symbol -20
		White (W)	
		Blue (BU)	
		Translucent (N)	
Ø 10	Ø 7.3	Black (B)	TUH1073 Colour symbol -20
		White (W)	
		Blue (BU)	
		Translucent (N)	
Ø 12	Ø 8.8	Black (B)	TUH1288 Colour symbol -20
		White (W)	
		Blue (BU)	
		Translucent (N)	

High Pressure Type

O.D.	I.D.	Colour (Symbol)	Model
Ø 4	Ø 2.5	Black (B)	TUH0425 Colour symbol -20
		White (W)	
		Blue (BU)	
		Translucent (N)	
Ø 6	Ø 4	Black (B)	TUH0604 Colour symbol -20
		White (W)	
		Blue (BU)	
		Translucent (N)	
Ø 8	Ø 5	Black (B)	TUH0805 Colour symbol -20
		White (W)	
		Blue (BU)	
		Translucent (N)	
Ø 10	Ø 6.5	Black (B)	TUH1065 Colour symbol -20
		White (W)	
		Blue (BU)	
		Translucent (N)	
Ø 12	Ø 8	Black (B)	TUH1208 Colour symbol -20
		White (W)	
		Blue (BU)	
		Translucent (N)	

Length per roll **100** m roll

O.D.	I.D.	Colour (Symbol)	Model
Ø 4	Ø 2.8	Black (B)	TUH0428 Colour symbol -100
		White (W)	
		Blue (BU)	
		Translucent (N)	
Ø 6	Ø 4.4	Black (B)	TUH0644 Colour symbol -100
		White (W)	
		Blue (BU)	
		Translucent (N)	
Ø 8	Ø 5.8	Black (B)	TUH0858 Colour symbol -100
		White (W)	
		Blue (BU)	
		Translucent (N)	
Ø 10	Ø 7.3	Black (B)	TUH1073 Colour symbol -100
		White (W)	
		Blue (BU)	
		Translucent (N)	
Ø 12	Ø 8.8	Black (B)	TUH1288 Colour symbol -100
		White (W)	
		Blue (BU)	
		Translucent (N)	

O.D.	I.D.	Colour (Symbol)	Model
Ø 4	Ø 2.5	Black (B)	TUH0425 Colour symbol -100
		White (W)	
		Blue (BU)	
		Translucent (N)	
Ø 6	Ø 4	Black (B)	TUH0604 Colour symbol -100
		White (W)	
		Blue (BU)	
		Translucent (N)	
Ø 8	Ø 5	Black (B)	TUH0805 Colour symbol -100
		White (W)	
		Blue (BU)	
		Translucent (N)	
Ø 10	Ø 6.5	Black (B)	TUH1065 Colour symbol -100
		White (W)	
		Blue (BU)	
		Translucent (N)	
Ø 12	Ø 8	Black (B)	TUH1208 Colour symbol -100
		White (W)	
		Blue (BU)	
		Translucent (N)	

⚠ Precautions

Be sure to read this before handling.
Refer to page 327 for Safety Instructions and pages 329 to 332 for Fittings and Tubing Precautions.

⚠ Caution

1. Please consult with SMC regarding other fluids. Because ester polyurethane is used, water cannot be used due to the occurrence of hydrolysis.
2. The value of the max. operating pressure is at a temperature of 20 °C. Refer to the burst pressure characteristics curve for other temperatures.
Furthermore, abnormal temperature rise caused by adiabatic compression may result in the tube bursting.
3. The value of the minimum bending radius is measured at the temperature of 20 °C as shown in the right figure.

How to measure the minimum bending radius.

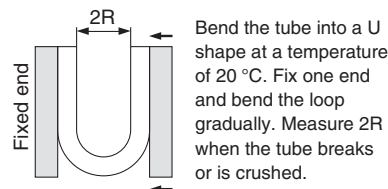

T
 TS
 TU
 TUS
TUH
 TUZ
 TCU
 TFCU
 T/TUS
 TUZ
 IDK
 TRS
 TRB
 TRBU
 TRTU
 TQ
 TAS
 TAU
 TL/
 TIL
 TLM/
 TILM
 TH/
 TIH
 TD/
 TID
 TPH
 TPS
 Related



Burst Pressure Characteristics Curve and Operating Pressure

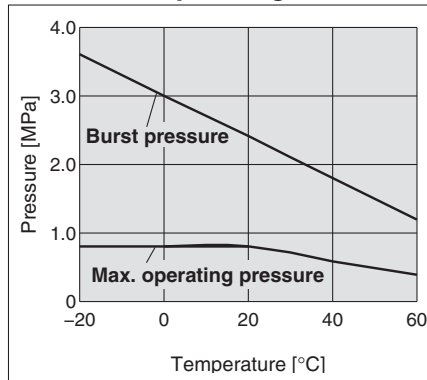

⚠ Precautions

Be sure to read this before handling. Refer to page 327 for Safety Instructions and pages 329 to 332 for Fittings and Tubing Precautions.

⚠ Caution

- The value of the max. operating pressure is at a temperature of 20 °C. Refer to the burst pressure characteristics curve for other temperatures. Furthermore, abnormal temperature rise caused by adiabatic compression may result in the tube bursting.
- The value of the minimum bending radius is measured at the temperature of 20 °C as shown in the right figure.

How to measure the minimum bending radius.

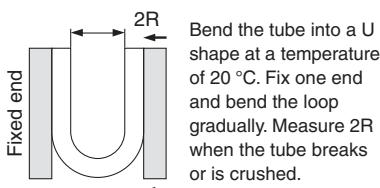

How to Order

TUZ0425 BU - 20

Tubing model		Colour		Length per roll	
Model	O.D. x I.D. [mm]	Symbol	Colour	Symbol	Length
TUZ0212	2 x 1.2	B	Black	20	20 m roll
TUZ3220	3.2 x 2	W	White	100	100 m roll
TUZ0425	4 x 2.5	R	Red		
TUZ0604	6 x 4	BU	Blue		
TUZ0805	8 x 5	Y	Yellow		
TUZ1065	10 x 6.5	G	Green		
TUZ1208	12 x 8				
TUZ1610	16 x 10				

Note) Not clear, but translucent due to material.

Model

Model	Tubing size							
	Metric size							
	TUZ0212	TUZ3220	TUZ0425	TUZ0604	TUZ0805	TUZ1065	TUZ1208	TUZ1610
Tubing O.D. [mm]	2	3.2	4	6	8	10	12	16
Tubing I.D. [mm]	1.2	2	2.5	4	5	6.5	8	10
Black (B)	<input type="checkbox"/>	<input checked="" type="checkbox"/>	<input checked="" type="checkbox"/>	<input checked="" type="checkbox"/>	<input checked="" type="checkbox"/>	<input checked="" type="checkbox"/>	<input checked="" type="checkbox"/>	<input type="checkbox"/>
White (W)		<input checked="" type="checkbox"/>	<input checked="" type="checkbox"/>	<input checked="" type="checkbox"/>	<input checked="" type="checkbox"/>	<input checked="" type="checkbox"/>	<input checked="" type="checkbox"/>	
Red (R)			<input checked="" type="checkbox"/>	<input checked="" type="checkbox"/>	<input checked="" type="checkbox"/>	<input checked="" type="checkbox"/>	<input checked="" type="checkbox"/>	
Blue (BU)		<input checked="" type="checkbox"/>	<input checked="" type="checkbox"/>	<input checked="" type="checkbox"/>	<input checked="" type="checkbox"/>	<input checked="" type="checkbox"/>	<input checked="" type="checkbox"/>	
Yellow (Y)			<input checked="" type="checkbox"/>	<input checked="" type="checkbox"/>	<input checked="" type="checkbox"/>	<input checked="" type="checkbox"/>	<input checked="" type="checkbox"/>	
Green (G)			<input checked="" type="checkbox"/>	<input checked="" type="checkbox"/>	<input checked="" type="checkbox"/>	<input checked="" type="checkbox"/>	<input checked="" type="checkbox"/>	

Specifications

Fluid	Air / Water							
Applicable fittings	One-touch fittings KQ2 series, Insert fittings KF series, Stainless steel 316 insert fittings KFG2 series, Miniature fittings M/MS series (hose nipple type)							
Max. operating pressure	20 °C	0.8 MPa						
	60 °C	0.4 MPa						
Burst pressure	Refer to the burst pressure characteristics curve.							
Min. bending radius [mm]	4	10	10	15	20	27	35	45
Operating temperature	-20 to +60 °C (Water: 0 to 40 °C) (No freezing)							
Material	Special polyurethane							

Note 1) The minimum bending radius means the value measured by the method shown in the figure at the left at the temperature of 20 °C when the tube is bent. The minimum bending radius assumes static piping. If the tube is used in a moving part, provide extra length to the tube. Check the bending radius recommended by the flexible protection tube manufacturer for sure if the tube is used in the flexible protection tube.

Note 2) Applicable for general industrial water. Please consult with SMC if using for the other kind of fluid. Also, the surge pressure must not exceed the maximum operating pressure. If the surge pressure exceeds the maximum operating pressure, it will result in damage to fittings and tubes.

Length per roll **20** m roll

O.D.	I.D.	Colour (Symbol)	Model
Ø 4	Ø 2.5	Black (B)	TUZ0425 [Colour symbol]-20
		White (W)	
		Red (R)	
		Blue (BU)	
		Yellow (Y)	
Ø 6	Ø 4	Black (B)	TUZ0604 [Colour symbol]-20
		White (W)	
		Red (R)	
		Blue (BU)	
		Yellow (Y)	
Ø 8	Ø 5	Black (B)	TUZ0805 [Colour symbol]-20
		White (W)	
		Red (R)	
		Blue (BU)	
		Yellow (Y)	
Ø 10	Ø 6.5	Black (B)	TUZ1065 [Colour symbol]-20
		White (W)	
		Red (R)	
		Blue (BU)	
		Yellow (Y)	
Ø 12	Ø 8	Black (B)	TUZ1208 [Colour symbol]-20
		White (W)	
		Red (R)	
		Blue (BU)	
		Yellow (Y)	
		Green (G)	

Length per roll **100** m roll

O.D.	I.D.	Colour (Symbol)	Model
Ø 4	Ø 2.5	Black (B)	TUZ0425 [Colour symbol]-100
		White (W)	
		Red (R)	
		Blue (BU)	
		Yellow (Y)	
Ø 6	Ø 4	Black (B)	TUZ0604 [Colour symbol]-100
		White (W)	
		Red (R)	
		Blue (BU)	
		Yellow (Y)	
Ø 8	Ø 5	Black (B)	TUZ0805 [Colour symbol]-100
		White (W)	
		Red (R)	
		Blue (BU)	
		Yellow (Y)	
Ø 10	Ø 6.5	Black (B)	TUZ1065 [Colour symbol]-100
		White (W)	
		Red (R)	
		Blue (BU)	
		Yellow (Y)	
Ø 12	Ø 8	Black (B)	TUZ1208 [Colour symbol]-100
		White (W)	
		Red (R)	
		Blue (BU)	
		Yellow (Y)	
		Green (G)	



Made to Order

1 Flat Type

X73

Wear Resistant Flat Tubing: Multi-core, same Colour specification Flat type of the TUZ series

The identification line is not shown. Please contact SMC for detailed specifications, dimensions, and delivery.

How to Order

TFU0425 BU - 2 - 20 - X73

Colour

Symbol	Colour
B	Black
W	White
R	Red
BU	Blue
Y	Yellow
G	Green

Note) Not clear, but translucent due to material.

Number of cores
2 to 12

Special polyurethane (Multi-core, same colour specification)

Length per roll

—	10 m
n	n m (Note)

Note) It is also available in lengths other than 10 m. Enter the length you need (1, 2, 3, 4, 5, 20).

Tubing model

Model	O.D. x I.D. [mm]
TFU0425	4 x 2.5
TFU0604	6 x 4
TFU0805	8 x 5
TFU1065	10 x 6.5
TFU1208	12 x 8

Example) TFU0425BU - 2 - 20 - X73

20 m

- T
- TS
- TU
- TUS
- TUH
- TUZ**
- TCU
- TFU
- TU/TUS
- TUZ
- IDK
- TRS
- TRB
- TRBU
- TRTU
- TQ
- TAS
- TAU
- TL/TIL
- TLM/TILM
- TH/TIH
- TD/TID
- TPH
- TPS
- Related

Compact piping possible



Burst Pressure Characteristics Curve and Operating Pressure

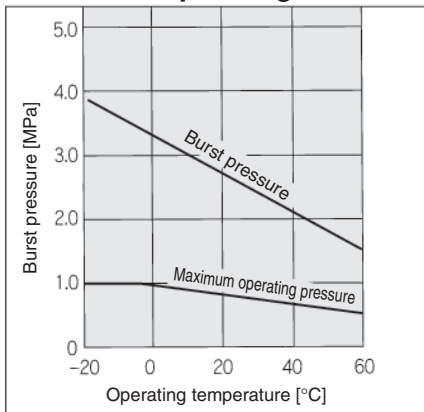

⚠ Precautions

Be sure to read this before handling. Refer to page 327 for Safety Instructions and pages 329 to 332 for Fittings and Tubing Precautions.

⚠ Caution

- Please consult with SMC regarding use with any fluids other than air.
- The value of the max. operating pressure is at a temperature of 20 °C. Refer to the burst pressure characteristics curve for other temperatures. Furthermore, abnormal temperature rise caused by adiabatic compression may result in the tube bursting.
- Please do not cut the coil and insert it into the fitting. This may cause air leakage, or tubing to come out after installation.

Specifications

Model	TCU 0425B-1	TCU 0425B-2	TCU 0425B-3	TCU 0604B-1	TCU 0604B-2	TCU 0604B-3	TCU 0805B-1
Number of cores	1 core	2 cores	3 cores	1 core	2 cores	3 cores	1 core
Tubing O.D. [mm]	4			6			8
Tubing I.D. [mm]	2.5			4			5
Fluid	Air						
Max. operating pressure (at 20 °C)	0.8 MPa						
Applicable fittings	One-touch fittings, Insert fittings, Miniature fittings						
Burst pressure	Refer to the burst pressure characteristics curve.						
Operating temperature	-20 to +60 °C						
Material	Polyurethane						
Colour	Black						

Coil Tubing

O.D.	I.D.	Colour	Number of cores	Max. operating length [m]	Model
Ø 4	Ø 2.5	Black (B)	1	1.5	TCU0425B-1
		Black (B)	2		TCU0425B-2
		Black (B)	3	1	TCU0425B-3
Ø 6	Ø 4	Black (B)	1	2	TCU0604B-1
		Black (B)	2	1.5	TCU0604B-2
		Black (B)	3	1	TCU0604B-3
Ø 8	Ø 5	Black (B)	1	2	TCU0805B-1



Made to Order

1 Change of Coil Turns, Change of Colour

X6

O.D.	I.D.	Number of cores	No. of coil windings per tube length	Model
Ø 4	Ø 2.5	1	3 to 90	TCU0425 [Colour symbol]-1-[No. of coil windings per tube length]-X6
		2	3 to 90	TCU0425 [Colour symbol]-2-[No. of coil windings per tube length]-X6
		3	3 to 63	TCU0425 [Colour symbol]-3-[No. of coil windings per tube length]-X6
Ø 6	Ø 4	1	3 to 90	TCU0604 [Colour symbol]-1-[No. of coil windings per tube length]-X6
		2	3 to 66	TCU0604 [Colour symbol]-2-[No. of coil windings per tube length]-X6
		3	3 to 44	TCU0604 [Colour symbol]-3-[No. of coil windings per tube length]-X6
Ø 8	Ø 5	1	3 to 90	TCU0805 [Colour symbol]-1-[No. of coil windings per tube length]-X6
		2	3 to 40	TCU0805 [Colour symbol]-2-[No. of coil windings per tube length]-X6
Ø 10	Ø 6.5	1	3 to 45	TCU1065 [Colour symbol]-1-[No. of coil windings per tube length]-X6
		2	3 to 35	TCU1065 [Colour symbol]-2-[No. of coil windings per tube length]-X6
Ø 12	Ø 8	1	3 to 35	TCU1208 [Colour symbol]-1-[No. of coil windings per tube length]-X6
		2	3 to 30	TCU1208 [Colour symbol]-2-[No. of coil windings per tube length]-X6

[Colour symbol]-B: Black, W: White, R: Red, BU: Blue, Y: Yellow, G: Green, C: Clear, YR: Orange

2 Clean Series

10-

Example) 10-TCU0425B-1

Multi-core, Multi-colour Polyurethane Coil Tubing



TCU-X192, X193, X198, X199 series

■ Can be identified and managed by colours!

Please contact SMC for availability

Series	Number of cores	Tubing colour (8 colours in total)							
		Black	White	Red	Blue	Yellow	Green	Clear	Orange
Polyurethane Coil Tubing TCU Series	2 cores 3 cores								

2 cores

Tubing O.D.: Ø 4 to Ø 12

Number of coil windings per tube length: 3 to 100¹⁾



3 cores

Tubing O.D.: Ø 4, Ø 6

Number of coil windings per tube length: 3 to 100¹⁾



Note 1) The maximum number of windings changes with the tube size.

Model	-X192	-X198	-X193	-X199
Number of cores	2 cores		3 cores	
Straight line length	100 mm	100 to 500 mm (Can be selected by 50 mm units.)	100 mm	100 to 500 mm (Can be selected by 50 mm units.)

- T
- TS
- TU
- TUS
- TUH
- TUZ
- TCU
- TFU
- TU/TUS
TUZ
- IDK
- TRS
- TRB
- TRBU
- TRTU
- TQ
- TAS
- TAU
- TL/
TIL
- TLM/
TILM
- TH/
TIH
- TD/
TID
- TPH
- TPS
- Related

Polyurethane Flat Tubing

RoHS

TFU Series

■ Tubing size: Metric Size

Compact piping possible



Burst Pressure Characteristics Curve and Operating Pressure

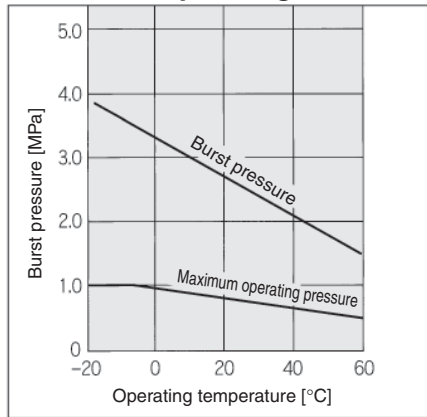

⚠ Precautions

Be sure to read this before handling. Refer to page 327 for Safety Instructions and pages 329 to 332 for Fittings and Tubing Precautions.

⚠ Caution

- Please consult with SMC regarding use with any fluids other than air.
- The value of the max. operating pressure is at a temperature of 20 °C. Refer to the burst pressure characteristics curve for other temperatures. Furthermore, abnormal temperature rise caused by adiabatic compression may result in the tube bursting.
- The value of the minimum bending radius is measured at the temperature of 20 °C as shown in the right figure.
- As a result of product design characteristics, there are cases of very slight leakage.

How to measure the minimum bending radius.

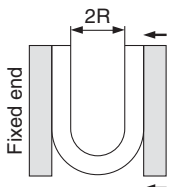

Bend the tube into a U shape at a temperature of 20 °C. Fix one end and bend the loop gradually. Measure 2R when the tube breaks or is crushed.

How to Order

TFU0425 B - 2

Tubing model Colour No. of tubes

Symbol	Colour
B	Black

Symbol	Number of cores
2	2 cores
3	3 cores

Specifications

Model	TFU 0425B-2	TFU 0425B-3	TFU 0604B-2	TFU 0604B-3	TFU 0805B-2	TFU 0805B-3
Number of cores	2 cores	3 cores	2 cores	3 cores	2 cores	3 cores
Tubing O.D. [mm]	4		6		8	
Tubing I.D. [mm]	2.5		4		5	
Fluid	Air					
Max. operating pressure (at 20 °C)	0.8 MPa					
Burst pressure	Refer to the burst pressure characteristics curve.					
Applicable fittings	One-touch fittings, Insert fittings, Miniature fittings					
Operating temperature	-20 to +60 °C (No freezing)					
Material	Polyurethane					
Colour	Black					
Min. bending radius [mm]	10		15		20	
Tube length per roll [m]	10					

Length per roll 10 m roll

O.D.	I.D.	Colour (Symbol)	Number of cores	Model
Ø 4	Ø 2.5	Black (B)	2	TFU0425B-2
		Black (B)	3	TFU0425B-3
Ø 6	Ø 4	Black (B)	2	TFU0604B-2
		Black (B)	3	TFU0604B-3
Ø 8	Ø 5	Black (B)	2	TFU0805B-2
		Black (B)	3	TFU0805B-3



Made to Order

1 No. of Cores, Change of Colour X4

Length per roll 10 m roll

O.D.	I.D.	Number of cores	Model
Ø 4	Ø 2.5	2 to 8	TFU0425 [Colour symbol] - [Number of cores] -10-X4
Ø 6	Ø 4	2 to 8	TFU0604 [Colour symbol] - [Number of cores] -10-X4
Ø 8	Ø 5	2 to 6	TFU0805 [Colour symbol] - [Number of cores] -10-X4
Ø 10	Ø 6.5	2 to 4	TFU1065 [Colour symbol] - [Number of cores] -10-X4
Ø 12	Ø 8	2 to 3	TFU1208 [Colour symbol] - [Number of cores] -10-X4

Colour symbol - W: White, R: Red, BU: Blue, Y: Yellow, G: Green, C: Clear, YR: Orange
All tubes are the same Colour regardless

2 Reel X3

Length per roll 50 m

O.D.	I.D.	Number of cores	Model
Ø 4	Ø 2.5	2	TFU0425 [Colour symbol] -2-50-X3
		3	TFU0425 [Colour symbol] -3-50-X3
Ø 6	Ø 4	2	TFU0604 [Colour symbol] -2-50-X3
		3	TFU0604 [Colour symbol] -3-50-X3
Ø 8	Ø 5	2	TFU0805 [Colour symbol] -2-50-X3
		3	TFU0805 [Colour symbol] -3-50-X3

Colour symbol - B: Black, W: White, R: Red, BU: Blue, Y: Yellow, G: Green, C: Clear, YR: Orange

3 Clean Series 10-

Example) 10-TFU0425B-2

Length per roll 100 m

O.D.	I.D.	Number of cores	Model
Ø 4	Ø 2.5	2	TFU0425 [Colour symbol] -2-100-X3
		3	TFU0425 [Colour symbol] -3-100-X3
Ø 6	Ø 4	2	TFU0604 [Colour symbol] -2-100-X3
		3	TFU0604 [Colour symbol] -3-100-X3
Ø 8	Ø 5	2	TFU0805 [Colour symbol] -2-100-X3

Colour symbol - B: Black, W: White, R: Red, BU: Blue, Y: Yellow, G: Green, C: Clear, YR: Orange

TU Series

■ Tubing size: **Metric Size**

■ Multi-core, Multi-colour Specification

Compact piping possible
8 colour variation



Burst Pressure Characteristics Curve and Operating Pressure

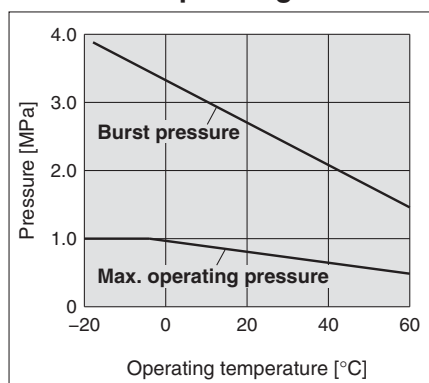

Specifications

Model	TU0212	TU0425	TU0604	TU0805	TU1065	TU1208
Tubing O.D. [mm]	2	4	6	8	10	12
Tubing I.D. [mm]	1.2	2.5	4	5	6.5	8
Black (B)	●	●	●	●	●	●
White (W)	●	●	●	●	●	●
Red (R)	●	●	●	●	●	●
Blue (BU)	●	●	●	●	●	●
Yellow (Y)	●	●	●	●	●	●
Green (G)	●	●	●	●	●	●
Clear (C)	●	●	●	●	●	●
Orange (YR)	●	●	●	●	●	●
Number of cores <small>(Note)</small>	2 cores	X169 (Roll)/X200 (Reel)				
	3 cores	X170 (Roll)/X201 (Reel)				
	4 cores	X171 (Roll)/X202 (Reel)				
	5 cores	X172 (Roll)/X203 (Reel)				
	6 cores	X204 (Roll)/X207 (Reel)				
Fluid	Air					
Max. operating pressure (at 20 °C)	0.8 MPa					
Burst pressure	Refer to the burst pressure characteristics curve.					
Applicable fittings	One-touch fitting, Insert fitting, Miniature fitting					
Min. bending radius [mm]	4	10	15	20	27	35
Operating temperature	-20 to +60 °C					
Material	Polyurethane					

Note) Refer to "How to Order" for the combination of tubing size and the number of cores.

⚠ Precautions

Be sure to read this before handling. Refer to page 327 for Safety Instructions and pages 329 to 332 for Fittings and Tubing Precautions.

⚠ Caution

- Please consult with SMC regarding use with any fluids other than air.
- The value of the max. operating pressure is at a temperature of 20 °C. Refer to the burst pressure characteristics curve for other temperatures. Furthermore, abnormal temperature rise caused by adiabatic compression may result in the tube bursting.
- The value of the minimum bending radius is measured at the temperature of 20 °C as shown in the right figure.
- As a result of product design characteristics, there are cases of very slight leakage.

How to measure the minimum bending radius.

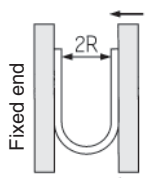

Bend the tube into a U shape at a temperature of 20 °C. Fix one end and bend the loop gradually. Measure 2R when the tube breaks or is crushed.

- T
- TS
- TU
- TUS
- TUH
- TUZ
- TCU
- TFU
- TU/TUS
- TUZ
- IDK
- TRS
- TRB
- TRBU
- TRTU
- TQ
- TAS
- TAU
- TL/TIL
- TLM/TILM
- TH/TIH
- TD/TID
- TPH
- TPS
- Related

How to Order

Roll

Tube length per roll: **1, 2, 3, 4, 5, 10, 20** m

TU 0425 - 12345 A - X172

• Tubing model

• Tubing size

Symbol	O.D. x I.D.
0212	Ø 2 x Ø 1.2
0425	Ø 4 x Ø 2.5
0604	Ø 6 x Ø 4
0805	Ø 8 x Ø 5
1065	Ø 10 x Ø 6.5
1208	Ø 12 x Ø 8

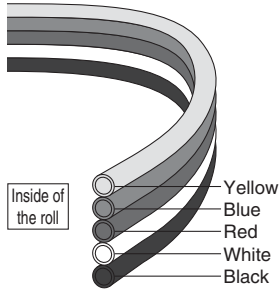

• Colour*1

Symbol	Colour	Symbol	Colour
1	Black	5	Yellow
2	White	6	Green
3	Red	7	Clear
4	Blue	8	Orange*2

*1 Colours of the example (12345)
*2 Except TU0212

• Multi-core, multi-colour specification

Symbol	Number of cores
X169	2 cores
X170	3 cores
X171	4 cores
X172	5 cores
X204	6 cores

• Tube length per roll [m]

Symbol	Length	Symbol	Length
A	1	E	5
B	2	F	10
C	3	G	20
D	4		

Tube length per roll: **50** m

TU 0425 - 12345 H - X172

• Tubing model

• Tubing size

Symbol	O.D. x I.D.
0425	Ø 4 x Ø 2.5
0604	Ø 6 x Ø 4
0805	Ø 8 x Ø 5
1065	Ø 10 x Ø 6.5
1208	Ø 12 x Ø 8

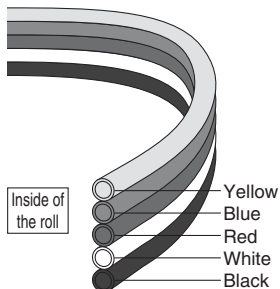

• Colour*1

Symbol	Colour	Symbol	Colour
1	Black	5	Yellow
2	White	6	Green
3	Red	7	Clear
4	Blue	8	Orange

*1 Colours of the example (12345)

• Multi-core, multi-colour specification

Symbol	Number of cores	Applicable tubing O.D.				
		Ø 4	Ø 6	Ø 8	Ø 10	Ø 12
X169	2 cores	•	•	•	•	•
X170	3 cores	•	•	•	•	•
X171	4 cores	•	•	•	•	•
X172	5 cores	•	•	•	•	•
X204	6 cores	•	•	•	•	•

• Tube length per roll [m]

Symbol	Length
H	50

Tube length per roll: **100** m

TU 0425 - 12345 J - X172

• Tubing model

• Tubing size

Symbol	O.D. x I.D.
0425	Ø 4 x Ø 2.5
0604	Ø 6 x Ø 4
0805	Ø 8 x Ø 5

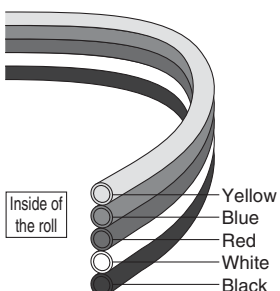

• Colour*1

Symbol	Colour	Symbol	Colour
1	Black	5	Yellow
2	White	6	Green
3	Red	7	Clear
4	Blue	8	Orange

*1 Colours of the example (12345)

• Multi-core, multi-colour specification

Symbol	Number of cores	Applicable tubing O.D.		
		Ø 4	Ø 6	Ø 8
X169	2 cores	•	•	•
X170	3 cores	•	•	•
X171	4 cores	•	•	•
X172	5 cores	•	•	•
X204	6 cores	•	•	•

• Tube length per roll [m]

Symbol	Length
J	100

How to Order

Reel

Tube length per roll: **10, 20** m

TU 0212 - 12345 F - X203

Colour Note 1)

Symbol	Colour	Symbol	Colour
1	Black	5	Yellow
2	White	6	Green
3	Red	7	Clear
4	Blue	8	Orange ²⁾

Note 1) Colours of the example (12345)
Note 2) Except TU0212

Multi-core, multi-colour specification

Symbol	Number of cores	Applicable tubing O.D.					
		Ø 2	Ø 4	Ø 6	Ø 8	Ø 10	Ø 12
X200	2 cores	●	●	●	●	●	●
X201	3 cores	●	●	●	●	●	●
X202	4 cores	●	●	●	●	●	●
X203	5 cores	●	●	●	●	●	●
X207	6 cores	●	●	●	●	●	●

Tube length per roll [m]

Symbol	Length
F	10
G	20

Tubing size

Symbol	O.D. x I.D.
0212	Ø 2 x Ø 1.2
0425	Ø 4 x Ø 2.5
0604	Ø 6 x Ø 4
0805	Ø 8 x Ø 5
1065	Ø 10 x Ø 6.5
1208	Ø 12 x Ø 8

Tube length per roll: **50** m

TU 0425 - 12345 H - X203

Colour Note 1)

Symbol	Colour	Symbol	Colour
1	Black	5	Yellow
2	White	6	Green
3	Red	7	Clear
4	Blue	8	Orange

Note 1) Colours of the example (12345)

Multi-core, multi-colour specification

Symbol	Number of cores	Applicable tubing O.D.			
		Ø 4	Ø 6	Ø 8	Ø 10
X200	2 cores	●	●	●	●
X201	3 cores	●	●	●	●
X202	4 cores	●	●	●	●
X203	5 cores	●	●	●	●
X207	6 cores	●	●	●	●

Tube length per roll [m]

Symbol	Length
H	50

Tubing size

Symbol	O.D. x I.D.
0425	Ø 4 x Ø 2.5
0604	Ø 6 x Ø 4
0805	Ø 8 x Ø 5
1065	Ø 10 x Ø 6.5

Tube length per roll: **100** m

TU 0425 - 12345 J - X203

Colour Note 1)

Symbol	Colour	Symbol	Colour
1	Black	5	Yellow
2	White	6	Green
3	Red	7	Clear
4	Blue	8	Orange

Note 1) Colours of the example (12345)

Multi-core, multi-colour specification

Symbol	Number of cores	Applicable tubing O.D.		
		Ø 4	Ø 6	Ø 8
X200	2 cores	●	●	●
X201	3 cores	●	●	●
X202	4 cores	●	●	●
X203	5 cores	●	●	●
X207	6 cores	●	●	●

Tube length per roll [m]

Symbol	Length
J	100

Tubing size

Symbol	O.D. x I.D.
0425	Ø 4 x Ø 2.5
0604	Ø 6 x Ø 4
0805	Ø 8 x Ø 5

Tube reel dimensions

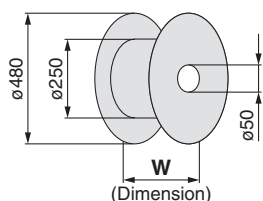

Model	W [mm]	Tube length per roll [m]			
		10	20	50	100
X200 (2 cores)	TU0212	51	51	—	—
	TU0425	51	51	51	51
	TU0604	51	51	81	156
	TU0805	81	81	156	156
	TU1065	156	156	156	—
	TU1208	156	156	—	—
X201 (3 cores)	TU0212	51	51	—	—
	TU0425	51	51	51	51
	TU0604	81	81	156	156
	TU0805	156	156	156	—

Model	W [mm]	Tube length per roll [m]			
		10	20	50	100
X202 (4 cores)	TU0212	51	51	—	—
	TU0425	51	51	81	81
	TU0604	81	81	156	205
	TU0805	156	156	—	—
X203 (5 cores)	TU0212	51	51	—	—
	TU0425	51	51	81	156
	TU0604	156	156	156	—
X207 (6 cores)	TU0212	51	51	—	—
	TU0425	51	51	81	156
	TU0604	156	156	156	—

- T
- TS
- TU
- TUS
- TUH
- TUZ
- TCU
- TFU
- TUTUS
- TUZ
- IDK
- TRS
- TRB
- TRBU
- TRTU
- TQ
- TAS
- TAU
- TL/TIL
- TLM/TILM
- TH/TIH
- TD/TID
- TPH
- TPS
- Related

Flat Tubing: Soft Polyurethane

RoHS

TUS Series

■ Tubing size: Metric Size

■ Multi-core, Multi-colour Specification

Compact piping possible
8 colour variations



TUS related accessories Inner sleeve Series TJ

Reinforces soft polyurethane tubing.

Insert an inner sleeve into soft polyurethane tubing when used with a One-touch fitting.

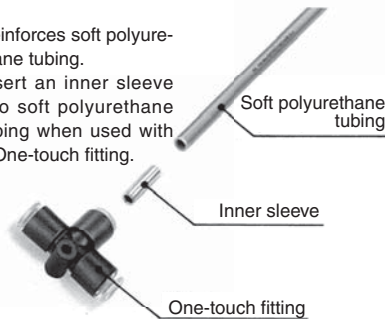

Model

Model	Applicable tubing model	Length
TJ-0425	TUS0425	18
TJ-0604	TUS0604	19
TJ-0805	TUS0805	20.5
TJ-1065	TUS1065	23
TJ-1208	TUS1208	24

Specifications

Material	C2700T (Electroless nickel plated)
Wall thickness	0.2 mm

⚠ Precautions

Be sure to read this before handling. Refer to page 327 for Safety Instructions and pages 329 to 332 for Fittings and Tubing Precautions.

⚠ Caution

- The value of the max. operating pressure is at a temperature of 20 °C. Refer to the burst pressure characteristics curve and operating pressure for other temperatures. Furthermore, abnormal temperature rise caused by adiabatic compression may result in the tube bursting.
- The value of the minimum bending radius is measured at the temperature of 20 °C as shown in the figure on the upper right.
- Use inner sleeve, taking the removing force into consideration when used with One-touch fittings.
- As a result of product design characteristics, there are cases of very slight leakage.

How to Order

TUS 0425 - 12345 A - X172

Tubing model

Tubing size

Symbol	O.D. x I.D.
0425	∅ 4 x ∅ 2.5
0604	∅ 6 x ∅ 4
0805	∅ 8 x ∅ 5
1065	∅ 10 x ∅ 6.5
1208	∅ 12 x ∅ 8

Multi-core, multi-colour specification

Symbol	Number of cores
X169	2 cores
X170	3 cores
X171	4 cores
X172	5 cores

Colour*1

Symbol	Colour	Symbol	Colour
1	Black	5	Yellow
2	White	6	Green
3	Red	7	Translucent*2
4	Blue	8	Yellow brown

*1 Colours of the example (12345)

*2 Not clear, but translucent due to material.

Tube length per roll [m]

Symbol	Length
A	1
B	2
C	3
D	4
E	5
F	10
G	20

Specifications

Model	TUS0425	TUS0604	TUS0805	TUS1065	TUS1208
Tubing O.D. [mm]	4	6	8	10	12
Tubing I.D. [mm]	2.5	4	5	6.5	8
Black (B)	●	●	●	●	●
White (W)	●	●	●	●	●
Red (R)	●	●	●	●	●
Blue (BU)	●	●	●	●	●
Yellow (Y)	●	●	●	●	●
Green (G)	●	●	●	●	●
Translucent (N)	●	●	●	●	●
Yellow brown (YB)	●	●	●	●	●

Number of cores	2 cores	X169 (Roll)				
	3 cores	X170 (Roll)				
	4 cores	X171 (Roll)				
	5 cores	X172 (Roll)				
Fluid	Air					
Max. operating pressure (at 20 °C)	0.6 MPa					
Burst pressure	Refer to the burst pressure characteristics curve.					
Applicable fittings	One-touch fitting ^{Note 2)} , Insert fitting, Hose nipple					
Min. bending radius ^{Note 1)} [mm]	8	15	15	22	29	
Operating temperature	-20 to +60 °C					
Material	Polyurethane					
Tube drawing strength (N) (Using One-touch fitting)	Without inner sleeve	15	60	60	85	110
	With inner sleeve	80	230	250	300	480

Note 1) Min. bending radius is measured as shown in the figure below.

How to measure the minimum bending radius

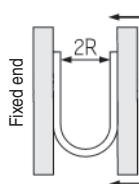

Bend the tube into a U shape at a temperature of 20 °C. Fix one end and bend the loop gradually. Measure 2R when the tube breaks or is crushed.

Note 2) Always use inner sleeve (Series TJ) in safety circuit or critical area.

Burst Pressure Characteristics Curve and Operating Pressure

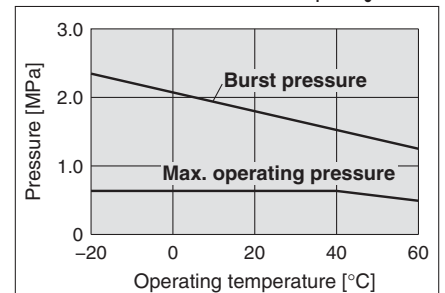

Flat Tubing: Wear Resistant



Tubing

TUZ Series

■ Tubing size: **Metric Size**

■ Multi-core, Multi-colour Specification

Compact piping possible
6 colour variation



Abrasion: Approx. 1/3

* Compared with SMC polyurethane tubing TU series (Refer to the table below)

Description	Maximum abrasion [mm]
	After 10 million cycles
Wear resistant tubing Series TUZ	0.16
Polyurethane tubing Series TU	0.46

Note) Comparison based on the SMC's specific testing condition

Burst Pressure Characteristics Curve and Operating Pressure

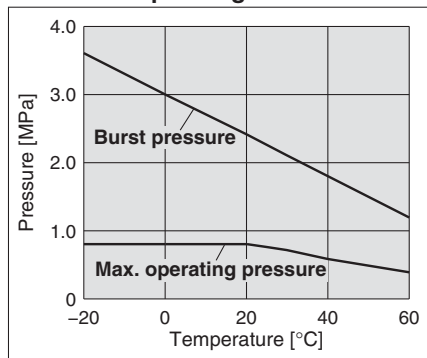

⚠ Precautions

Be sure to read this before handling. Refer to page 327 for Safety Instructions and pages 329 to 332 for Fittings and Tubing Precautions.

⚠ Caution

1. Please consult with SMC regarding use with any fluids other than air.
2. The value of the max. operating pressure is at a temperature of 20 °C. Refer to the burst pressure characteristics curve for other temperatures. Furthermore, abnormal temperature rise caused by adiabatic compression may result in the tube bursting.
3. As a result of product design characteristics, there are cases of very slight leakage.

How to measure the minimum bending radius.

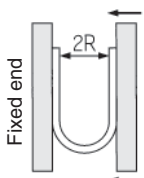

Bend the tube into a U shape at a temperature of 20 °C. Fix one end and bend the loop gradually. Measure 2R when the tube breaks or is crushed.

Specifications

Model	TUZ0425	TUZ0604	TUZ0805	TUZ1065	TUZ1208
Tubing O.D. [mm]	4	6	8	10	12
Tubing I.D. [mm]	2.5	4	5	6.5	8
Black (B)	●	●	●	●	●
White (W)	●	●	●	●	●
Red (R)	●	●	●	●	●
Blue (BU)	●	●	●	●	●
Yellow (Y)	●	●	●	●	●
Green (G)	●	●	●	●	●
Number of cores	2 cores	X169 (Roll)			
	3 cores	X170 (Roll)			
	4 cores	X171 (Roll)			
	5 cores	X172 (Roll)			
	6 cores	X204 (Roll)			
Fluid	Air				
Max. operating pressure	20 °C	0.8 MPa			
	60 °C	0.4 MPa			
Burst pressure	Refer to the burst pressure characteristics curve.				
Applicable fittings	One-touch fitting, Insert fitting, Hose nipple				
Min. bending radius ^{Note)} [mm]	10	15	20	27	35
Operating temperature	-20 to +60 °C				
Material	Special polyurethane				

Note) The minimum bending radius means the value measured by the method shown in the figure on the left below at the temperature of 20 °C when the tube is bent. The minimum bending radius assumes static piping. If the tube is used in a moving part, provide extra length to the tube. Check the bending radius recommended by the flexible protection tube manufacturer for sure if the tube is used in the flexible protection tube. In addition, refer to the [WEB catalogue at www-smc.eu](http://www-smc.eu)

- T
- TS
- TU
- TUS
- TUH
- TUZ
- TCU
- TFU
- TU/TUS TUZ
- IDK
- TRS
- TRB
- TRBU
- TRTU
- TQ
- TAS
- TAU
- TL/TIL
- TLM/TILM
- TH/TIH
- TD/TID
- TPH
- TPS
- Related

How to Order

Roll

Tube length per roll: **1, 2, 3, 4, 5, 10, 20** m

TUZ 0425 - 12345 A - X172

Multi-core, multi-colour specification

Symbol	Number of cores
X169	2 cores
X170	3 cores
X171	4 cores
X172	5 cores
X204	6 cores

Tube length per roll [m]

Symbol	Length	Symbol	Length
A	1	E	5
B	2	F	10
C	3	G	20
D	4		

Tubing size

Symbol	O.D. x I.D.
0425	Ø 4 x Ø 2.5
0604	Ø 6 x Ø 4
0805	Ø 8 x Ø 5
1065	Ø 10 x Ø 6.5
1208	Ø 12 x Ø 8

Colour*1*2

Symbol	Colour	Symbol	Colour
1	Black	4	Blue
2	White	5	Yellow
3	Red	6	Green

*1 Colours of the example (12345)
*2 Not clear, but translucent due to material.

Inside of the roll

Yellow
Blue
Red
White
Black

Tube length per roll: **50** m

TUZ 0425 - 12345 H - X172

Multi-core, multi-colour specification

Symbol	Number of cores	Applicable tubing O.D.				
		Ø 4	Ø 6	Ø 8	Ø 10	Ø 12
X169	2 cores	●	●	●	●	●
X170	3 cores	●	●	●	●	●
X171	4 cores	●	●	●	●	●
X172	5 cores	●	●	●	●	●
X204	6 cores	●	●	●	●	●

Tube length per roll [m]

Symbol	Length
H	50

Tubing size

Symbol	O.D. x I.D.
0425	Ø 4 x Ø 2.5
0604	Ø 6 x Ø 4
0805	Ø 8 x Ø 5
1065	Ø 10 x Ø 6.5
1208	Ø 12 x Ø 8

Colour*1*2

Symbol	Colour	Symbol	Colour
1	Black	4	Blue
2	White	5	Yellow
3	Red	6	Green

*1 Colours of the example (12345)
*2 Not clear, but translucent due to material.

Inside of the roll

Yellow
Blue
Red
White
Black

Tube length per roll: **100** m

TUZ 0425 - 12345 J - X172

Multi-core, multi-colour specification

Symbol	Number of cores	Applicable tubing O.D.		
		Ø 4	Ø 6	Ø 8
X169	2 cores	●	●	●
X170	3 cores	●	●	●
X171	4 cores	●	●	●
X172	5 cores	●	●	●
X204	6 cores	●	●	●

Tube length per roll [m]

Symbol	Length
J	100

Tubing size

Symbol	O.D. x I.D.
0425	Ø 4 x Ø 2.5
0604	Ø 6 x Ø 4
0805	Ø 8 x Ø 5

Colour*1*2

Symbol	Colour	Symbol	Colour
1	Black	4	Blue
2	White	5	Yellow
3	Red	6	Green

*1 Colours of the example (12345)
*2 Not clear, but translucent due to material.

Inside of the roll

Yellow
Blue
Red
White
Black

Fluoropolymer Tubing

IDK Series

■ Tubing size: Metric Size

Prevents condensation in piping

for small cylinders/air grippers.

Diffuses water vapour in the piping to the outside!

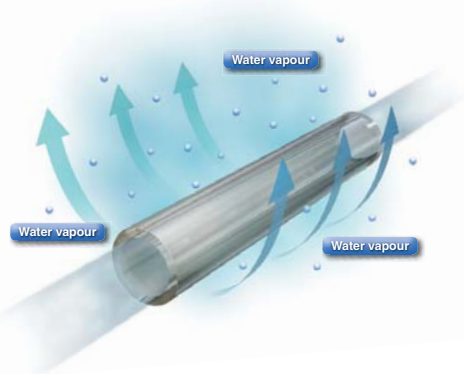

Linear shape

Suitable for applications where cylinders do not rotate.



How to Order

IDK **02** - **100**

Tube O.D.

Symbol	O.D.
02	2 mm
04	4 mm
06	6 mm

Tube effective length

Symbol	Effective length
100	100 mm
200	200 mm

Specifications (Linear shape)

Model	IDK02	IDK04	IDK06
Fluid	Compressed air		
Max. operating pressure	0.7 MPa		
Installation temperature Relative humidity	40 °C / 75 % RH or less		
Operating temperature (°C)	0 to 60 (No freezing)		
Operating environment *1	Indoors, where product is not exposed to water (0 to 40 °C, Relative humidity 0 to 75 % RH)		
Min. bending radius *2 (mm)	10	20	40
O.D. (mm)	2	4	6
I.D. (mm)	1.2	2.5	4
Inner sleeve I.D. [mm]	0.8	2.1	3.4
Quantity of moisture control tubes	2 pcs.		
Accessories	Inner sleeve 4 pcs. (already mounted into tube)		
Colour	Transparent	[Colour will change to brown over time, but the functions are not affected.]	
Applicable fittings	KQ2, KJ		
Material	Fluoropolymer		

Note 1) Use the moisture control tube in a line with a refrigerated air dryer and a mist separator installed in the upstream compressed air line. The condensation prevention performance may be lowered depending on the quality of the supply compressed air (oil, dew point).

Note 2) The inner sleeve is already mounted and cannot be removed. If the inner sleeve comes off, re-insert the sleeve before mounting the fitting.

Note 3) Do not cut the tube.

*1 Use the product in an operating environment where humidity is as low as possible.

*2 The value at which the moisture control tube is bent or flattened at 20 °C. Be careful not to bend or flatten the tube and the inner sleeve even if the value is more than the minimum bending radius.

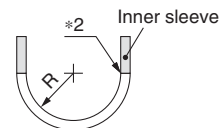

How to Order



IDK **04** - **100** - **C1**

• Tube O.D.

Symbol	O.D.
04	4 mm
06	6 mm

• Coil shape

• Tube effective length

Symbol	Effective length
100	100 mm
200	200 mm

Note) Part number for a set of 2 tubes

Specifications (Coil shape)

Model	IDK04-□-C1	IDK06-□-C1
Fluid	Compressed air	
Max. operating pressure	0.7 MPa	
Fluid temperature	0 to 60°C (No freezing)	
Ambient temperature	0 to 40°C, Relative humidity 0 to 75%RH	
Operating environment ^{*1}	Indoors, where product is not exposed to water (0 to 40°C, Relative humidity 0 to 75%RH)	
O.D. [mm]	4	6
I.D. [mm]	2.5	4
Tube effective length ^{*2} [mm]	100, 200	
Quantity of moisture control tubes	2 pcs.	
Color	Transparent [Color will change to brown over time, but the functions are not affected.]	
Applicable fittings	KQ2	
Material	Fluoropolymer	

Note 1) Use the moisture control tube in a line with a refrigerated air dryer and a mist separator installed in the upstream compressed air line. The condensation prevention performance may be lowered depending on the quality of the supply compressed air (oil, dew point).

Note 2) The inner sleeve is already mounted and cannot be removed. If the inner sleeve comes off, re-insert the sleeve before mounting the fitting.

Note 3) Do not cut the tube.

*1 Use the product in an operating environment where humidity is as low as possible.

*2 The length when the tube is straight. This effective length is made into a coil shape.

New

Coil shape

Reduces tube buckling of moving part.



Mounting

⚠ Caution

1. Do not use the moisture control tubes bundled together.
Otherwise, the performance may be decreased.
2. Connect the tube directly to the fitting of the actuator or air operated valve.
If the tube is connected to other places, condensation will not be prevented and vapor will be generated.

Mounting position

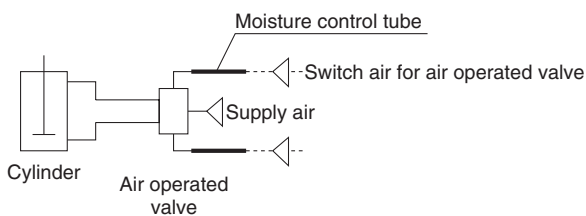
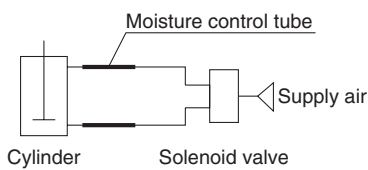

3. Clean the tube and actuator by air blowing to eliminate moisture before connecting them to the circuit with condensation.

⚠ Caution

If the moisture control tube is mounted to an actuator where condensation has been generated, it is possible that the grease has been washed away. Make sure to add grease to the actuator based on the maintenance procedure of the actuator.

Installation

⚠ Caution

1. Install a refrigerated air dryer and a mist separator in the compressed air line. The condensation prevention performance may be lowered depending on the quality of the supply compressed air (oil, dew point).

Recommended Model

Description	Model
Refrigerated air dryer	IDF/IDU
Mist separator	AM/AFM

2. Select the moisture control tube with the same diameter as the tube connected.

Example) TU0604 → IDK06-□00

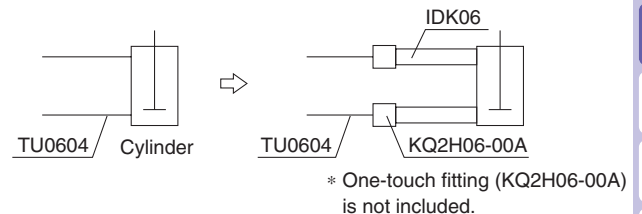

3. The inner sleeve is already mounted. It cannot be removed. If the inner sleeve comes off, re-insert the inner sleeve into the tube again before mounting it to the fitting.
4. Do not cut the moisture control tube.
5. Applicable fittings: One-touch fittings KQ2, KJ. Other types of fittings must not be used.

T

TS

TU

TUS

TUH

TUZ

TCU

TFU

TU/TUS
TUZ

IDK

TRS

TRB

TRBU

TRTU

TQ

TAS

TAU

TL/
TIL

TLM/
TILM

TH/
TIH

TD/
TID

TPH

TPS

Related

TRS series

■ Tubing size: **Metric Size**

Spatter Proof

Suitable for air and water piping in environments where sparks from spot welders, etc., may be a problem.
Flame resistant tubing

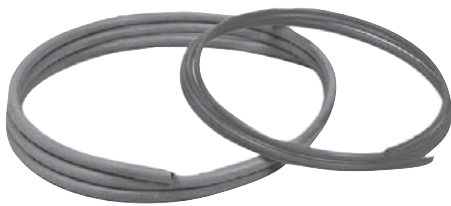

How to Order

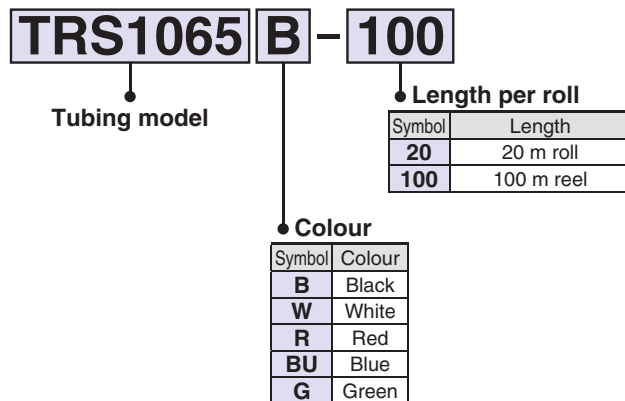

Burst Pressure Characteristics Curve and Operating Pressure

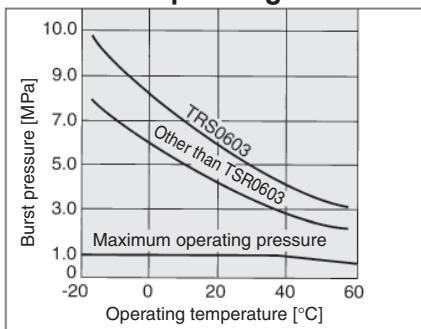

⚠ Precautions

Be sure to read this before handling. Refer to page 327 for Safety Instructions and pages 329 to 332 for Fittings and Tubing Precautions.

⚠ Caution

- Applicable for general industrial water. Please consult with SMC if using for the other kind of fluid. Also, the surge pressure must not exceed the maximum operating pressure. If the surge pressure exceeds the maximum operating pressure, it will result in damage to fittings and tubes.
- The value of the max. operating pressure is at a temperature of 20 °C. Refer to the burst pressure characteristics curve for other temperatures. Furthermore, abnormal temperature rise caused by adiabatic compression may result in the tube bursting.

Model

● -20 m roll □ -100 m reel

Model	Tubing size			
	Metric size			
	TRS0603	TRS0805	TRS1065	TRS1208
Tubing O.D. [mm]	6	8	10	12
Tubing I.D. [mm]	3	5	6.5	8
Black (B)	●	●	●	●
White (W)	●	●	●	●
Red (R)	●	●	●	●
Blue (BU)	●	●	●	●
Green (G)	●	●	●	●

Specifications

Fluid	Air / Water			
Max. operating pressure (at 20 °C)	1.2 MPa			
Burst pressure	Refer to the burst pressure characteristics curve.			
Recommended fittings	FR One-touch fittings: Series KR-W2			
Min. bending radius [mm]	17	19	27	32
Operating temperature	-20 to +60 °C, Water: 0 to 60 °C (No freezing)			
Material	Flame resistant nylon (Equivalent to UL-94 standard V-0)			

Length per roll **20** m roll

O.D.	I.D.	Colour (Symbol)	Model
Ø 6	Ø 3	Black (B)	TRS0603 Colour symbol -20
		White (W)	
		Red (R)	
		Blue (BU)	
		Green (G)	
Ø 8	Ø 5	Black (B)	TRS0805 Colour symbol -20
		White (W)	
		Red (R)	
		Blue (BU)	
		Green (G)	
Ø 10	Ø 6.5	Black (B)	TRS1065 Colour symbol -20
		White (W)	
		Red (R)	
		Blue (BU)	
		Green (G)	
Ø 12	Ø 8	Black (B)	TRS1208 Colour symbol -20
		White (W)	
		Red (R)	
		Blue (BU)	
		Green (G)	

Length per roll **100** m reel

O.D.	I.D.	Colour (Symbol)	Model
Ø 6	Ø 3	Black (B)	TRS0603 Colour symbol -100
		White (W)	
		Red (R)	
		Blue (BU)	
		Green (G)	
Ø 8	Ø 5	Black (B)	TRS0805 Colour symbol -100
		White (W)	
		Red (R)	
		Blue (BU)	
		Green (G)	
Ø 10	Ø 6.5	Black (B)	TRS1065 Colour symbol -100
		White (W)	
		Red (R)	
		Blue (BU)	
		Green (G)	
Ø 12	Ø 8	Black (B)	TRS1208 Colour symbol -100
		White (W)	
		Red (R)	
		Blue (BU)	
		Green (G)	

- T
- TS
- TU
- TUS
- TUH
- TUZ
- TCU
- TFU
- TU/TUS
TUZ
- IDK
- TRS**
- TRB
- TRBU
- TRTU
- TQ
- TAS
- TAU
- TL/
TIL
- TLM/
TILM
- TH/
TIH
- TD/
TID
- TPH
- TPS
- Related

TRB Series

■ Tubing size: **Metric Size**

Suitable for air and water piping in environments where sparks from spot welders, etc., may be a problem. Double layer design using flame resistant resin (equivalent to UL-94 Standard V-0) for outer layer.

Spatter Proof

How to Order

TRB1075 B - 100

Tubing model ●

● Length per roll

Symbol	Length
20	20 m roll
100	100 m roll

● Colour

Symbol	Colour
B	Black
W	White
R	Red
BU	Blue
Y	Yellow
G	Green

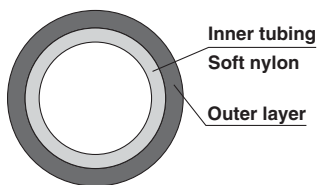

Sectional view of FR double layer tubing

Burst Pressure Characteristics Curve and Operating Pressure

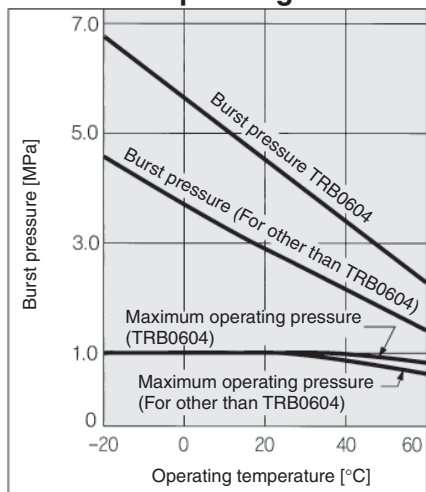

Model

● -20 m roll □ - 100 m reel

Model	Tubing size			
	Metric size			
	TRB0604	TRB0806	TRB1075	TRB1209
Inner tubing O.D. [mm]	6	8	10	12
Inner tubing I.D. [mm]	4	6	7.5	9
Outer layer thickness [mm]	1	1	1	1

External layer colour (Note)	Black (B)	White (W)	Red (R)	Blue (BU)	Yellow (Y)	Green (G)
	●	□	●	□	●	□
	●	□	●	□	●	□
	●	□	●	□	●	□
	●	□	●	□	●	□
	●	□	●	□	●	□

Specifications

Fluid	Air/Water			
Max. operating pressure (at 20 °C)	1 MPa			
Burst pressure	Refer to the burst pressure characteristics curve.			
Recommended fittings	FR One-touch fittings: Series KR-W2			
Min. bending radius [mm]	15	28	35	45
Ambient and fluid temperature	-20 to +60 °C, Water: 0 to 60 °C (No freezing)			
Material	Inner tubing	Nylon 12		
	Outer layer	PVC (Equivalent to UL-94 Standard V-0)		

Note) The colour of all inner tubing is black.

Length per roll **20** m roll

O.D.	I.D.	Colour (Symbol)	Model
Ø 6	Ø 4	Black (B)	TRB0604 Colour symbol -20
		White (W)	
		Red (R)	
		Blue (BU)	
		Yellow (Y)	
Ø 8	Ø 6	Black (B)	TRB0806 Colour symbol -20
		White (W)	
		Red (R)	
		Blue (BU)	
		Yellow (Y)	
Ø 10	Ø 7.5	Black (B)	TRB1075 Colour symbol -20
		White (W)	
		Red (R)	
		Blue (BU)	
		Yellow (Y)	
Ø 12	Ø 9	Black (B)	TRB1209 Colour symbol -20
		White (W)	
		Red (R)	
		Blue (BU)	
		Yellow (Y)	
		Green (G)	

Length per roll **100** m reel

O.D.	I.D.	Colour (Symbol)	Model
Ø 6	Ø 4	Black (B)	TRB0604 Colour symbol -100
		White (W)	
		Red (R)	
		Blue (BU)	
		Yellow (Y)	
Ø 8	Ø 6	Black (B)	TRB0806 Colour symbol -100
		White (W)	
		Red (R)	
		Blue (BU)	
		Yellow (Y)	
Ø 10	Ø 7.5	Black (B)	TRB1075 Colour symbol -100
		White (W)	
		Red (R)	
		Blue (BU)	
		Yellow (Y)	
Ø 12	Ø 9	Black (B)	TRB1209 Colour symbol -100
		White (W)	
		Red (R)	
		Blue (BU)	
		Yellow (Y)	
		Green (G)	

- T
- TS
- TU
- TUS
- TUH
- TUZ
- TCU
- TFU
- TU/TUS
TUZ
- IDK
- TRS
- TRB**
- TRBU
- TRTU
- TQ
- TAS
- TAU
- TL/
TIL
- TLM/
TILM
- TH/
TIH
- TD/
TID
- TPH
- TPS
- Related

⚠ Precautions

Be sure to read this before handling.
Refer to page 327 for Safety Instructions and pages 329 to 332 for Fittings and Tubing Precautions.

⚠ Caution

- Applicable for general industrial water. Please consult with SMC if using for the other kind of fluid. Also, the surge pressure must not exceed the maximum operating pressure. If the surge pressure exceeds the maximum operating pressure, it will result in damage to fittings and tubes.
- The value of the max. operating pressure is at a temperature of 20 °C. Refer to the burst pressure characteristics curve for other temperatures. Furthermore, abnormal temperature rise caused by adiabatic compression may result in the tube bursting.
- The value of the minimum bending radius is measured at the temperature of 20 °C as shown in the right figure.

How to measure the minimum bending radius.

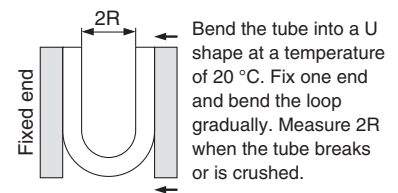

Double Layer Tube Stripper

Series TKS

Allows easy stripping of the outer layer from double layer tubes.

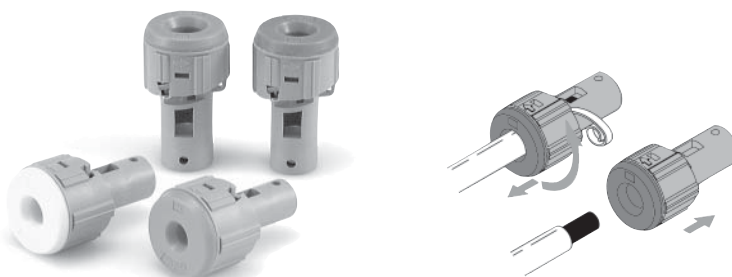

Variations

Model	Tip colour	Applicable tubing*
TKS-06	Orange	TRB0604, TRBU0604
TKS-08	Yellow	TRB0806, TRBU0805
TKS-10	Blue	TRB1075, TRBU1065
TKS-12	Green	TRB1209, TRBU1208

* Inner tubing material/TRB: Soft nylon,
TRBU: Polyurethane

TRBU Series

■ Tubing size: **Metric Size**

Spatter Proof

Suitable for air and water piping in environments where sparks from spot welders, etc., may be a problem. Double layer design using flame resistant resin (equivalent to UL-94 Standard V-0) for outer layer.

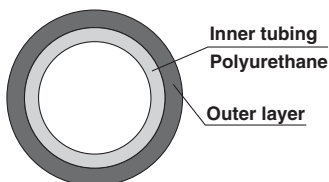

Sectional view of FR double layer polyurethane tubing

Burst Pressure Characteristics Curve and Operating Pressure

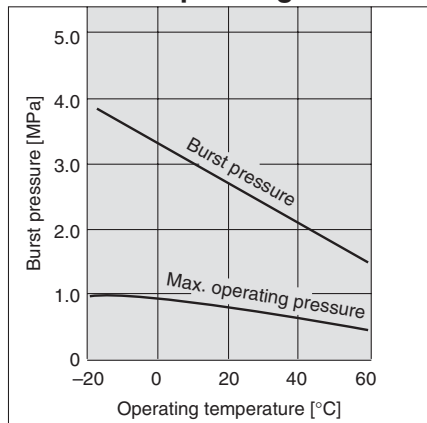

Related Products:

Tube Stripper Series TKS

A special tool for stripping off outer tube layers



How to Order

TRBU1065 B - 100

Tubing model

Length per roll

Symbol	Length
20	20 m roll
100	100 m reel

Colour

Symbol	Colour	Symbol	Colour
B	Black	BU	Blue
W	White	Y	Yellow
R	Red	G	Green

Model

● - 20 m roll □ - 100 m reel

Model	Tubing size				
	Metric size				
	TRBU0604	TRBU0805	TRBU1065	TRBU1208	
Inner tubing O.D. [mm]	6	8	10	12	
Inner tubing I.D. [mm]	4	5	6.5	8	
Outer layer thickness [mm]	1	1	1	1	
External layer colour <small>(Note)</small>	Black (B)	●	●	●	●
	White (W)	●	●	●	●
	Red (R)	●	●	●	●
	Blue (BU)	●	●	●	●
	Yellow (Y)	●	●	●	●
	Green (G)	●	●	●	●

Specifications

Fluid	Air / Water			
Max. operating pressure (at 20 °C)	0.8 MPa			
Burst pressure	Refer to the burst pressure characteristics curve.			
Recommended fittings	FR One-touch fittings: Series KR-W2			
Min. bending radius [mm]	15	20	27	35
Ambient and fluid temperature	-20 to +60 °C, Water: 0 to 40 °C (No freezing)			
Material	Inner tubing	Polyurethane		
	Outer layer	Polyolefin (Equivalent to UL-94 standard V-0)		

(Note) The colour of all inner tubing is black.

Length per roll **20** m roll

O.D.	I.D.	Colour (Symbol)	Model
Ø 6	Ø 4	Black (B)	TRBU0604 Colour symbol -20
		White (W)	
		Red (R)	
		Blue (BU)	
		Yellow (Y)	
Ø 8	Ø 5	Black (B)	TRBU0805 Colour symbol -20
		White (W)	
		Red (R)	
		Blue (BU)	
		Yellow (Y)	
Ø 10	Ø 6.5	Black (B)	TRBU1065 Colour symbol -20
		White (W)	
		Red (R)	
		Blue (BU)	
		Yellow (Y)	
Ø 12	Ø 8	Black (B)	TRBU1208 Colour symbol -20
		White (W)	
		Red (R)	
		Blue (BU)	
		Yellow (Y)	
		Green (G)	

Length per roll **100** m reel

O.D.	I.D.	Colour (Symbol)	Model
Ø 6	Ø 4	Black (B)	TRBU0604 Colour symbol -100
		White (W)	
		Red (R)	
		Blue (BU)	
		Yellow (Y)	
Ø 8	Ø 5	Black (B)	TRBU0805 Colour symbol -100
		White (W)	
		Red (R)	
		Blue (BU)	
		Yellow (Y)	
Ø 10	Ø 6.5	Black (B)	TRBU1065 Colour symbol -100
		White (W)	
		Red (R)	
		Blue (BU)	
		Yellow (Y)	
Ø 12	Ø 8	Black (B)	TRBU1208 Colour symbol -100
		White (W)	
		Red (R)	
		Blue (BU)	
		Yellow (Y)	
		Green (G)	

⚠ Precautions

Be sure to read this before handling.
Refer to page 327 for Safety Instructions and pages 329 to 332 for Fittings and Tubing Precautions.

⚠ Caution

- Applicable for general industrial water. Please consult with SMC if using for the other kind of fluid. Also, the surge pressure must not exceed the maximum operating pressure. If the surge pressure exceeds the maximum operating pressure, it will result in damage to fittings and tubes.
- The value of the max. operating pressure is at a temperature of 20 °C. Refer to the burst pressure characteristics curve for other temperatures. Furthermore, abnormal temperature rise caused by adiabatic compression may result in the tube bursting.
- The value of the minimum bending radius is measured at the temperature of 20 °C as shown in the right figure.

How to measure the minimum bending radius.

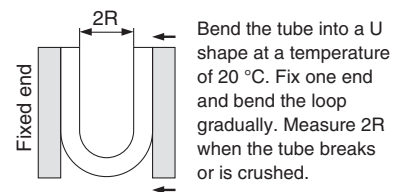

- T
- TS
- TU
- TUS
- TUH
- TUZ
- TCU
- TFU
- TU/TUS
- TUZ
- IDK
- TRS
- TRB
- TRBU
- TRTU
- TQ
- TAS
- TAU
- TL/TIL
- TLM/TILM
- TH/TIH
- TD/TID
- TPH
- TPS
- Related

TRTU Series

■ Tubing size: **Metric Size**

Spatter Proof

Improved spatter resistance
Spatter resistance is that of
FR double layer polyurethane
tubing TRBU series.

* In SMC conditions

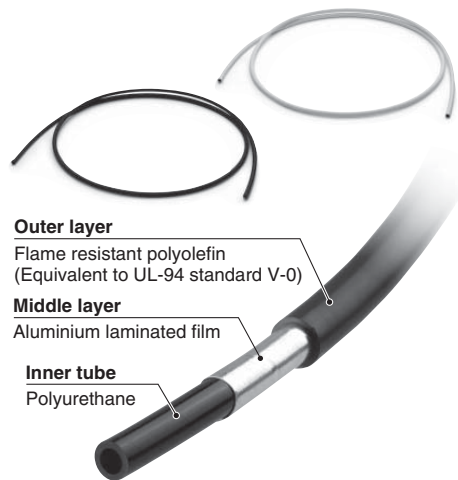

For general pneumatic and water piping in environments exposed to sparks from arc welding, etc.

How to measure the minimum bending radius.

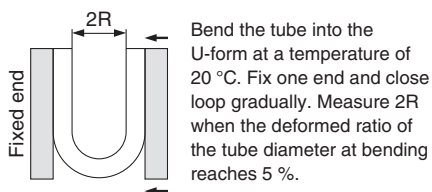

Burst Pressure Characteristics Curve and Operating Pressure

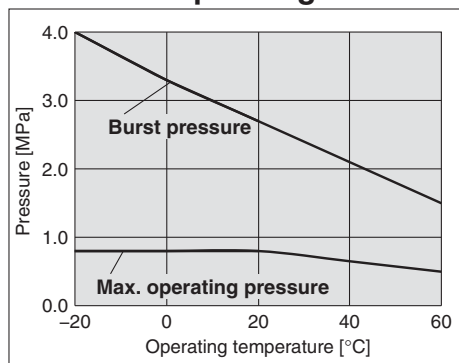

Model

● -20 m roll □ -100 m reel

Model	TRTU0604	TRTU0805	TRTU1065	TRTU1208
Inner tubing O.D. [mm]	6	8	10	12
Inner tubing I.D. [mm]	4	5	6.5	8
Outer layer thickness [mm]	1	1	1	1

External layer colour	Black (B)	●	●	●	●
	White (W)	□	□	□	□
	Red (R)	●	●	●	●
	Blue (BU)	●	●	●	●
	Yellow (Y)	●	●	●	●
	Green (G)	●	●	●	●

Specifications

Fluid ^{Note 1)}		Air/Water			
Applicable fittings		FR One-touch fittings: Series KR-W2 Metal One-touch fittings: Series KQB2			
Max. operating pressure	at 20 °C	0.8 MPa			
	at 40 °C	0.65 MPa			
	at 60 °C	0.5 MPa			
Burst pressure		Refer to the burst pressure characteristics curve.			
Min. bending radius [mm] ^{Note 2)}		50	60	70	80
Ambient and fluid temperature		-20 to +60 °C, Water: 0 to 40 °C (No freezing)			
Material	Inner tubing	Polyurethane			
	Middle layer	Aluminium laminated film			
	Outer layer	Polyolefin (Equivalent to UL-94 standard V-0)			

Note 1) Applicable for general industrial water. Please consult with SMC if using for the other kind of fluid. Also, the surge pressure must not exceed the maximum operating pressure. If the surge pressure exceeds the maximum operating pressure, it will result in damage to fittings and tubes.

Note 2) The minimum bending radius is the representative value measured as shown in the left figure. Allow extra length when piping since the tube may be bent if used under the minimum bending radius.

Note 3) The colour of all inner tubes is black.

How to Order

TRTU1065 B - 20

Tubing model		Colour	Length per roll															
Model	Inner tube O.D. x I.D. [mm]		Symbol	Length														
TRTU0604	6 x 4	<table border="1"> <tr><th>Symbol</th><th>Colour</th></tr> <tr><td>B</td><td>Black</td></tr> <tr><td>W</td><td>White</td></tr> <tr><td>R</td><td>Red</td></tr> <tr><td>BU</td><td>Blue</td></tr> <tr><td>Y</td><td>Yellow</td></tr> <tr><td>G</td><td>Green</td></tr> </table>	Symbol	Colour	B	Black	W	White	R	Red	BU	Blue	Y	Yellow	G	Green	20	20 m roll
Symbol	Colour																	
B	Black																	
W	White																	
R	Red																	
BU	Blue																	
Y	Yellow																	
G	Green																	
TRTU0805	8 x 5	100	100 m reel															
TRTU1065	10 x 6.5																	
TRTU1208	12 x 8																	

Length per roll **20** m roll

O.D.	I.D.	Colour (Symbol)	Model
Ø 6	Ø 4	Black (B)	TRTU0604 Colour symbol -20
		White (W)	
		Red (R)	
		Blue (BU)	
		Yellow (Y)	
Ø 8	Ø 5	Black (B)	TRTU0805 Colour symbol -20
		White (W)	
		Red (R)	
		Blue (BU)	
		Yellow (Y)	
Ø 10	Ø 6.5	Black (B)	TRTU1065 Colour symbol -20
		White (W)	
		Red (R)	
		Blue (BU)	
		Yellow (Y)	
Ø 12	Ø 8	Black (B)	TRTU1208 Colour symbol -20
		White (W)	
		Red (R)	
		Blue (BU)	
		Yellow (Y)	
		Green (G)	

Length per roll **100** m reel

O.D.	I.D.	Colour (Symbol)	Model
Ø 6	Ø 4	Black (B)	TRTU0604 Colour symbol -100
		White (W)	
		Red (R)	
		Blue (BU)	
		Yellow (Y)	
Ø 8	Ø 5	Black (B)	TRTU0805 Colour symbol -100
		White (W)	
		Red (R)	
		Blue (BU)	
		Yellow (Y)	
Ø 10	Ø 6.5	Black (B)	TRTU1065 Colour symbol -100
		White (W)	
		Red (R)	
		Blue (BU)	
		Yellow (Y)	
Ø 12	Ø 8	Black (B)	TRTU1208 Colour symbol -100
		White (W)	
		Red (R)	
		Blue (BU)	
		Yellow (Y)	
		Green (G)	

⚠ Precautions

- Be sure to read this before handling.
- Refer to page 327 for Safety Instructions and pages 329 to 332 for Fittings and Tubing Precautions.

A tool for stripping off the outer layers of three layer tubing

Use a special tool for stripping off the outer layer.

Part no.: **YS-100**

* Refer to the Operation Manual for details of how to use the special tool.

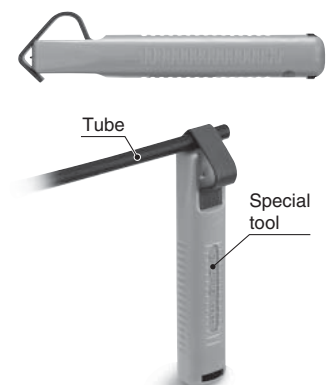

- T
- TS
- TU
- TUS
- TUH
- TUZ
- TCU
- TFU
- TU/TUS
- TUZ
- IDK
- TRS
- TRB
- TRBU
- TRTU
- TQ
- TAS
- TAU
- TL/TIL
- TLM/TILM
- TH/THH
- TD/TID
- TPH
- TPS
- Related

2-Layer Soft Fluoropolymer Tubing

RoHS

TQ Series

■ Tubing size: **Metric Size**

Carries fluid such as solvent with a soft and abrasion resistant tube.



Corrosion Resistant

Heat Resistant

Specifications

Designation		TQ0425	TQ0604	TQ0806	TQ1008	TQ1209
Tubing O.D. [mm]		4	6	8	10	12
Tubing I.D. [mm]		2.5	4	6	8	9
Roll	20 m	●	●	●	●	●
	100 m	●	●	●	●	●
Colour ^{Note 1)}		Translucent (Material colour)				
Fluid ^{Note 2)}		Air, Water, Inert gas, Solvent				
Applicable fittings ^{Note 3)}		Insert fittings KF, KFG2, VCK series Miniature fittings M, MS series (Hose nipple type) Fluoropolymer fittings LQ1, LQ3 series ^{Note 6)}				
Max. operating pressure MPa ^{Note 4)}	20 °C	2.0	1.9	1.5	1.1	1.2
Min. bending radius (tube close bend radius) ^{Note 5)} [mm]		4	9	26	42	37
Fluid temperature (fixed usage)		Air, Inert gas: -20 to 100 °C, Water, Solvent: 0 to 70 °C (No freezing)				
Material		Inner layer: Special fluoropolymer, Outer layer: Special nylon resin				

Note 1) There may be plasticizer (white powder) deposits on the external surface of the tube. Please be careful when the tube is used in clean rooms. Otherwise, the clean level may decrease.

Note 2) When solvent is used, make sure to test in the same environment as the actual operating environment, and confirm that no problem will occur in the operating conditions. The standard value of the Applicable Fluid List below is the reference value based on the test result performed under specific conditions.

The product can be physically affected by temperature, pressure, chemical density, etc, causing permeation or swelling, and this may cause some problems. For details, refer to the **WEB catalogue** at www.smc.eu.

Note 3) Perform periodic maintenance inspections. If leakage continues to occur after tightening, replace the tube with a new one. (Refer to "Maintenance" in the Specific Product Precautions of the TQ series in the **WEB catalogue** at www.smc.eu)

When the tube rotates, perform a test to make sure no problem occur in the actual operating conditions.

When the product is used with motion for a long time, or at a high temperature, the tubes may have leakage due to deterioration of the materials.

Note 4) Observe the lesser value of the maximum operating pressure between the tubing and fitting. The surge pressure must not exceed the maximum operating pressure. If the surge pressure exceeds the maximum operating pressure, it will result in damage to tubes and fittings. Furthermore, abnormal temperature rise caused by adiabatic compression may result in the tube bursting.

Note 5) Minimum bend radius (tube close bend radius) is not guaranteed. The value of 2R in the left figure is measured with a bent or flattened tube.

Note 6) For the installation of fluoropolymer fitting LQ1 and LQ3, please contact SMC.

How to measure the minimum bending radius.

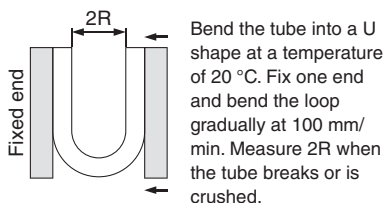

How to Order

TQ0425 - **20**

Tubing model Length per roll

Symbol	Length
20	20 m roll
100	100 m roll

Max. Operating Pressure

Unit: MPa

Temperature [°C]	TQ0425	TQ0604	TQ0806	TQ1008	TQ1209
-20 to 20	2.0	1.9	1.5	1.1	1.2
30	1.7	1.6	1.2	0.9	1.0
40	1.4	1.4	1.0	0.8	0.9
50	1.2	1.1	0.8	0.6	0.8
60	1.1	1.0	0.7	0.5	0.7
70	1.0	0.9	0.6	0.4	0.6
80	0.9	0.8	0.5	0.4	0.5
90	0.8	0.7	0.4	0.3	0.4
100	0.7	0.6	0.4	0.3	0.3

Applicable Fluid List

Fluid in the list below are chemically inert ^{Note 1)}, to tubing material. Possible physical effects may occur such as penetration and swelling due to temperature, pressure and chemical density. To use tubing in a solvent environment, tests should be performed with the same environment to ensure no problem occurs with operating environment.

Chemical	Inner layer	Outer layer	Chemical	Inner layer	Outer layer
	Special fluoropolymer	Special nylon resin		Special fluoropolymer	Special nylon resin
Hydrochloric acid	○	△	Citric acid	○	△
Sulfuric acid	○	△	Stearic acid	○	△
Nitric acid	○	×	Formic acid	○	△
Caustic soda	○	△	Ethyl acetate	○	○
Caustic potash	○	△	Butyl acetate	○	△
Ammonium hydroxide	○	○	Methyl alcohol	○	○
Hydrogen peroxide	○	△	Ethyl alcohol	○	○
Water	○	○	Butyl alcohol	○	○
Phenol	○	×	Isopropyl alcohol	△	○
Benzene	○	△	Cellosolve	△	△
Toluene	○	△	Hexane	○	△
Xylene	○	△	Cyclohexane	○	△
Carbon tetrachloride	○	×	Mineral oil ASTM No.3	○	○
Acetone	○	△	Naphtha	○	○
Methyl ethyl ketone	○	△			

Note 1) "Chemically inert" means – not to cause any chemical reaction.

Note 2) Criteria: ○Applicable, △Not recommended, ×Inapplicable

Note 3) Applicable Fluid List shows the reference value based on test results performed under specific conditions. Application for products is not guaranteed.

Note 4) Applicable Fluid List is for tube materials. For use in environments containing solvents, please contact SMC.

Length per roll **20** m roll

O.D.	I.D.	Colour	Model
Ø 4	Ø 2.5	Translucent (Material colour)	TQ0425-20
Ø 6	Ø 4		TQ0604-20
Ø 8	Ø 6		TQ0806-20
Ø 10	Ø 8		TQ1008-20
Ø 12	Ø 9		TQ1209-20

Length per roll **100** m roll

O.D.	I.D.	Colour	Model
Ø 4	Ø 2.5	Translucent (Material colour)	TQ0425-100
Ø 6	Ø 4		TQ0604-100
Ø 8	Ø 6		TQ0806-100
Ø 10	Ø 8		TQ1008-100
Ø 12	Ø 9		TQ1209-100

⚠ Precautions

Be sure to read this before handling.
Refer to page 327 for Safety Instructions and pages 329 to 332 for Fittings and Tubing Precautions.

Selection

⚠ Warning

- Check the specifications.**
Give careful consideration to operating conditions such as the application, fluid and environment, and use within the operating ranges specified in this catalogue. Tube may burst or lead to operation failure if operating conditions are out of the specification range. The specifications of the catalogue are designed assuming the product is used with the fixed conditions.
- When using the product for medical care**
This product is designed for use with compressed fluid system applications for medical care purposes. Do not use in contact with human bodily fluids, body tissues or transfer applications to a human living body.
- Maintenance**
Perform periodic maintenance inspections, securing enough space for maintenance.
- Countermeasures for static electricity**
Since static electricity may be generated depending on the fluid being used, implement suitable countermeasures.

⚠ Caution

- When toxic solvent is used, make sure to test in the same environment as the actual operating environment, and confirm that no problem will occur in the operating conditions.**
- When the joint of the tube or fitting rotates, make sure to test it in the same environment as the actual operating environment, and confirm that no problems will occur in the operating conditions.**
- The surge pressure must not exceed the maximum operating pressure.**
- There may be plasticizer (white powder) deposits on the external surface of the tube. Please be careful when the tube is used in clean rooms. Otherwise, the clean level may decrease.**
- If fittings of brands other than SMC are used, be sure to confirm that no problem will occur with the operating conditions.**
- Trademark, product number, the material of inner/outer layer, O.D. x I.D. size, production lot number, and country of origin are printed in 500 mm intervals on the outer surface of the tube. Printed letters may be erased depending on fluid.**

Mounting

⚠ Caution

- Check the model number, size, etc. before installing. Check tubing for damage, gouges, cracks, etc.**
- Before piping, perform air blow (flushing) or cleaning to remove any dust, etc. from the piping.**
- There may be plasticizer (white powder) deposits on the surface of the tube, but there is no impact on performance.**
- Cut the tube perpendicularly using a tube cutter.**
If the tube is cut incorrectly, fluid can leak or the tube can fall out as a result.
- When connecting tubing, allow a sufficient margin considering the change of tube diameter and length due to pressure.**
- Do not apply unnecessary forces such as twisting, pulling, moment loads on fittings or tubing. It may cause leakage, the fitting to fracture or the tube to be crushed, burst or fall off.**
- Mount so that tubing is not damaged due to tangling and abrasion. This can cause flattening, bursting or disconnection of tubing, etc. If the LQ1 or LQ3 fitting is used, connect the tube with the specialized tool.**
Refer to the pamphlet "High-Purity Fluoropolymer Fittings HYPER FITTING/ Series LQ1, 2 Work Procedure Instructions" (M-E05-1) or "High Purity Fluoropolymer Fittings Hyper Fitting/Flare Type Series LQ3 Fitting Procedure" (M-E06-4A) for connecting tubing and special tools. (Downloadable from our website)

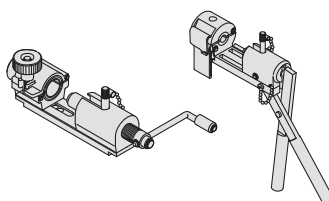

Operating Environment

⚠ Warning

- Do not use in locations having an explosive atmosphere.**
- When vibration or impact is applied, make sure to test in the same environment as the actual operating environment, and confirm that no problem will occur in the operating conditions.**
- In locations near heat sources, block off radiated heat.**

Maintenance

⚠ Caution

- Check the following after the initial installation and for each periodic inspection. If any problem is confirmed, replace the tube with a new product or reconsider the customer's operating conditions.**
 - Cracks, gouges, wearing, corrosion
 - Leakage, penetration, dissolution
 - Twists or crushing of tubing
 - Hardening, deterioration, softening of tubing

*There may be plasticizer (white powder) deposits on the surface of the tube, but there is no impact on performance.
- The two layers of the tube are completely bonded. If separation is confirmed between them, replace the tube with a new one or reconsider the customer's operating conditions.**
- If the tube and the fitting are removed or replaced, eliminate the residual fluid with air or water.**
- When using insert, miniature or fluoropolymer fittings over a long period, some leakage may occur due to age deterioration of the materials. If any leakage is detected, correct the problem by additional tightening. If tightening becomes ineffective, replace the fittings with a new product immediately.**
- Do not repair or patch the replaced tubing or fittings for reuse.**

T
TS
TU
TUS
TUH
TUZ
TCU
TFU
TU/TUS
TUZ
IDK
TRS
TRB
TRBU
TRTU
TQ
TAS
TAU
TL/
TIL
TLM/
TILM
TH/
TIH
TD/
TID
TPH
TPS
Related

Antistatic Soft Nylon Tubing

RoHS

TAS Series

■ Tubing size: Metric Size

For pneumatic piping and applications which require the measures against antistatic electricity.

Flame resistant tubing (Equivalent to UL-94 standard V-0)



Burst Pressure Characteristics Curve and Operating Pressure

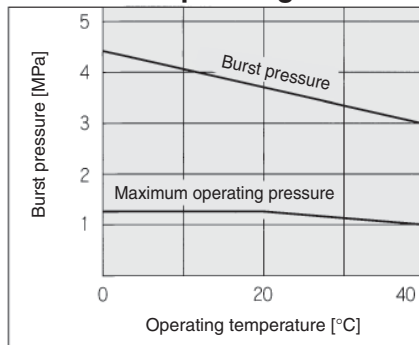

⚠ Precautions

Be sure to read this before handling. Refer to page 327 for Safety Instructions and pages 329 to 332 for Fittings and Tubing Precautions.

⚠ Caution

- The value of the max. operating pressure is at a temperature of 20 °C. Refer to the burst pressure characteristics curve for other temperatures. Furthermore, abnormal temperature rise caused by adiabatic compression may result in the tube bursting.
- The value at temperature of 20 °C and O.D. variable rate 10% max.

Antistatic Measures

How to Order

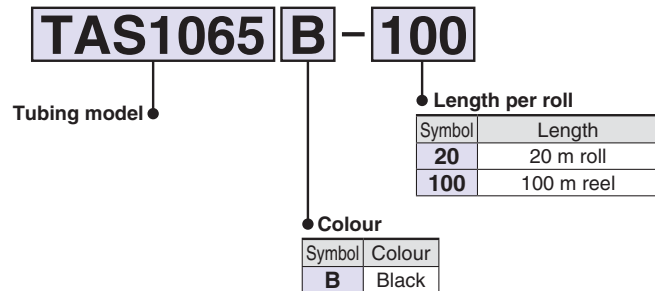

Model

● - 20 m roll □ - 100 m reel

Model	Tubing size					
	Metric size					
Tubing O.D. [mm]	3.2	4	6	8	10	12
Tubing I.D. [mm]	2.2	2.5	4	5	6.5	8
Black (B)	●	●	●	●	●	●

Specifications

Fluid	Air					
Max. operating pressure (at 20 °C)	1.2 MPa					
Burst pressure	Refer to the burst pressure characteristics curve.					
Recommended fittings	Antistatic one-touch fittings: Series KA Miniature fittings: Series M and MS ^(Note)					
Min. bending radius [mm]	12	12	15	19	27	32
Operating temperature	0 to 40 °C					
Material	Conductive nylon + Flame resistant nylon (Equivalent to UL-94 standard V-0)					
Surface resistance	10 ⁴ to 10 ⁷ Ω					

Note) Miniature fittings: Only the following types are available for Series M and MS

Series M	Series MS
M-3AU-3, M-3AU-4, M-5AU-3, M-5AU-4 M-5AU-6, M-5H-4, M-5H-6	MS-5AU-3, MS-5AU-4, MS-5AU-6 MS-5H-4, MS-5H-6

Length per roll 20 m roll

O.D.	I.D.	Colour (Symbol)	Model
Ø 3.2	Ø 2.2	Black (B)	TAS3222B-20
Ø 4	Ø 2.5	Black (B)	TAS0425B-20
Ø 6	Ø 4	Black (B)	TAS0604B-20
Ø 8	Ø 5	Black (B)	TAS0805B-20
Ø 10	Ø 6.5	Black (B)	TAS1065B-20
Ø 12	Ø 8	Black (B)	TAS1208B-20

Length per roll 100 m reel

O.D.	I.D.	Colour (Symbol)	Model
Ø 3.2	Ø 2.2	Black (B)	TAS3222B-100
Ø 4	Ø 2.5	Black (B)	TAS0425B-100
Ø 6	Ø 4	Black (B)	TAS0604B-100
Ø 8	Ø 5	Black (B)	TAS0805B-100
Ø 10	Ø 6.5	Black (B)	TAS1065B-100
Ø 12	Ø 8	Black (B)	TAS1208B-100

Antistatic Polyurethane Tubing

RoHS

TAU Series

■ Tubing size: Metric Size

For pneumatic piping and applications which require the measures against antistatic electricity.

Flexible tubing



Burst Pressure Characteristics Curve and Operating Pressure

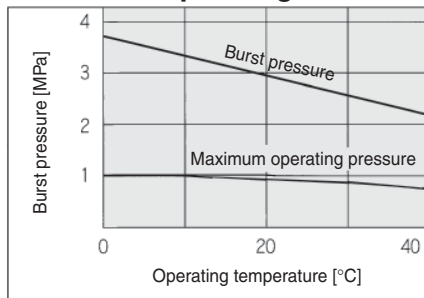

⚠ Precautions

Be sure to read this before handling. Refer to page 327 for Safety Instructions and pages 329 to 332 for Fittings and Tubing Precautions.

⚠ Caution

- The value of the max. operating pressure is at a temperature of 20 °C. Refer to the burst pressure characteristics curve for other temperatures. Furthermore, abnormal temperature rise caused by adiabatic compression may result in the tube bursting.
- The value of the minimum bending radius is measured at the temperature of 20 °C as shown below.
- Because ester polyurethane is adopted, water cannot be used due to the occurrence of hydrolysis.

How to measure the minimum bending radius.

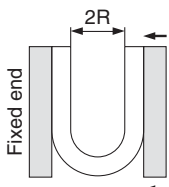

Bend the tube into a U shape at a temperature of 20 °C. Fix one end and bend the loop gradually. Measure 2R when the tube breaks or is crushed.

Antistatic Measures

How to Order

TAU1065 B - 100

Tubing model

Colour

Length per roll

Symbol	Colour
B	Black

Symbol	Length
20	20 m roll
100	100 m reel

Model

● - 20 m roll □ - 100 m reel

Model	Tubing size					
	Metric size					
Tubing O.D. [mm]	3.2	4	6	8	10	12
Tubing I.D. [mm]	2	2.5	4	5	6.5	8

Black (B)	●	□	●	□	●	□

Specifications

Fluid	Air					
Max. operating pressure (at 20 °C)	0.9 MPa					
Burst pressure	Refer to the burst pressure characteristics curve.					
Recommended fittings	Antistatic one-touch fittings: Series KA [m]iniature fittings: Series M and MS ^{Note}					
Min. bending radius [mm]	10	10	15	20	27	35
Operating temperature	0 to 40 °C					
Material	Conductive polyurethane					
Surface resistance	10 ⁴ to 10 ⁷ Ω					

Note) Miniature fittings: Only the following types are available for Series M and MS

Series M	Series MS
M-3AU-3, M-3AU-4, M-5AU-3, M-5AU-4 M-5AU-6, M-5H-4, M-5H-6	MS-5AU-3, MS-5AU-4, MS-5AU-6 MS-5H-4, MS-5H-6

Length per roll 20 m roll

O.D.	I.D.	Colour (Symbol)	Model
Ø 3.2	Ø 2	Black (B)	TAU3220B-20
Ø 4	Ø 2.5	Black (B)	TAU0425B-20
Ø 6	Ø 4	Black (B)	TAU0604B-20
Ø 8	Ø 5	Black (B)	TAU0805B-20
Ø 10	Ø 6.5	Black (B)	TAU1065B-20
Ø 12	Ø 8	Black (B)	TAU1208B-20

Length per roll 100 m reel

O.D.	I.D.	Colour (Symbol)	Model
Ø 3.2	Ø 2	Black (B)	TAU3220B-100
Ø 4	Ø 2.5	Black (B)	TAU0425B-100
Ø 6	Ø 4	Black (B)	TAU0604B-100
Ø 8	Ø 5	Black (B)	TAU0805B-100
Ø 10	Ø 6.5	Black (B)	TAU1065B-100
Ø 12	Ø 8	Black (B)	TAU1208B-100



Made to Order

1 Change of Colour, Surface Resistance 10⁹ Ω

X100

Specifications

Fluid	Air
Max. operating pressure (at 20 °C)	0.8 MPa
Ambient and fluid temperature	0 to 40 °C
Material	Antistatic polyurethane
Surface resistance	10 ⁹ Ω
Recommended fittings	Antistatic one-touch fittings: Series KA Miniature fittings: Series M and MS ^{Note}

Note) Miniature fittings: Only the following types are available for Series M and MS

Series M	Series MS
M-3AU-2, M-3AU-4, M-5AU-2 M-5AU-4, M-5AU-6, M-5H-4, M-5H-6	MS-5AU-4, MS-5AU-6 MS-5H-4, MS-5H-6

O.D.	I.D.	Model
2	1.2	TAU0212 [Colour symbol]-20-X100
4	2.5	TAU0425 [Colour symbol]-20-X100
6	4	TAU0604 [Colour symbol]-20-X100
8	5	TAU0805 [Colour symbol]-20-X100
10	6.5	TAU1065 [Colour symbol]-20-X100
12	8	TAU1208 [Colour symbol]-20-X100

[Colour symbol]: B: Black, W: White, BU: Blue, G: Green, C: Clear

Fluoropolymer Tubing

RoHS

TL/TIL Series

■ Tubing size: Metric Size, Inch Size

Material: Super PFA



Note 1) • The maximum operating pressure is the value at 20 °C. For other temperatures, calculate from the burst pressure drop coefficient.

Furthermore, an abnormal temperature increase due to adiabatic compression can cause tubing to burst. To operate at a temperature other than 20 °C, the operating pressure must be no more than the value calculated using the equation below: When the value (calculated using the formula below) exceeds 1 MPa, the Max. operating pressure is 1 MPa.

(Max. operating pressure) =

$$1/4 \times (\text{burst pressure drop coefficient}) \times (\text{burst pressure at } 20 \text{ }^\circ\text{C})$$

- When using a fluid in liquid form, the surge pressure must be no more than the maximum operating pressure. A surge pressure higher than the maximum operating pressure can cause breakage of the fitting or bursting of the tubing.

Note 2) The minimum bending radius is measured using the method shown in the figure at the below.

Note 3) One-touch and insert fittings can also be used. As for other commercial items, there are some cases it is not able to connect due to tolerance of dimensions.

How to measure the minimum bending radius.

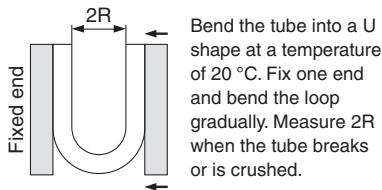

Burst Pressure Drop Curve

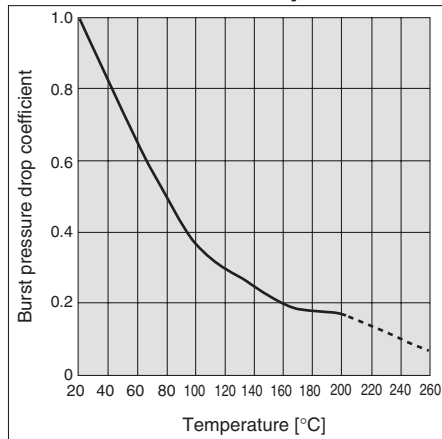

Corrosion Resistant

Heat Resistant

Clean

Model/Specifications

		Metric sizes (Series TL)						Inch sizes (Series TIL)							
Tubing model		TL0403	TL0604	TL0806	TL1008	TL1210	TL1916	TIL01	TILB01	TIL05	TIL07	TIL11	TIL13	TIL19	TIL25
Nominal diameter		—						1/8"		3/16"	1/4"	3/8"	1/2"	3/4"	1"
Tubing size		04 x 03	06 x 04	08 x 06	10 x 08	12 x 010	19 x 016	1/8" x 0.086"	1/8" x 1/16"	3/16" x 1/8"	1/4" x 5/32"	3/8" x 1/4"	1/2" x 3/8"	3/4" x 5/8"	1" x 7/8"
O.D. [mm]	Basic diameter	4	6	8	10	12	19	3.18		4.75	6.35	9.53	12.7	19.05	25.4
	Tolerance	±0.1			+0.2 -0.1		±0.1			+0.2 -0.1					
Thickness [mm]	Basic diameter	0.5		1			1.5	0.5	0.8	1.2	1.6				
	Tolerance	±0.05		±0.1			±0.15	±0.05	±0.08	±0.12	±0.15				
Bundle	10 m	—	—	—	●	●	●	—	—	—	—	●	●	—	—
	20 m	●	●	●	●	●	●	—	—	●	●	●	●	●	●
	50 m	●	●	●	●	●	●	—	—	●	●	●	●	●	●
	100 m	●	●	●	●	●	●	—	—	●	●	●	●	●	—
	50 Ft. (16 m)	—	—	—	—	—	—	●	●	●	●	●	●	●	●
100 Ft. (33 m)	—	—	—	—	—	—	●	●	●	●	●	●	●	●	
Straight pipe 2 m		●	●	●	●	●	●	—	—	●	●	●	●	●	●
Colour		Translucent (Colour of material)													
Applicable fluid		Refer to the applicable fluid in page 334.													
Applicable fittings (Note 3)		Series LQ													
Max. operating pressure (at 20 °C) [MPa] (Note 1)		1			0.9	0.7	0.6	1			0.7			0.5	
Burst pressure (at 20 °C) [MPa]		4.9	6.9	4.7	3.6	2.9	2.6	6.4	9.9	6.7	7.9	6.7	4.6	2.8	2.0
Min. bending radius [mm] (Note 2)		20		40	65	110	160	12	6	20	30	60	160	290	
Max. operating temperature (Fixed use)		260 °C													
Material		Super PFA													

How to Order

Metric sizes

TL0604 - 20

Inch sizes

TIL01 - 20

Tubing model

Length

Applicable to both metric and inch size

Symbol	Type	Length
10	Roll	10 m
20		20 m
50		50 m
100		100 m
2S	Straight	2 m

Length Applicable to inch size only

Symbol	Type	Length
16	Roll	50 Ft. (16 m)
33		100 Ft. (33 m)

Please refer to the "Series and Specifications" above, as the tubing length differs depending on each size.

Eluting fluorine ion amount (Note 4) [µg/g]

Type	Fluorine ion
Eluting amount	0.1 or less

A 15 g piece of fluororesin tubing is cut off, washed in DI water (pure water) and immersed in 15 ml of 25 % methyl alcohol extract at room temperature for 24 hours. Then the extract is diluted with DI water (pure water) to be subjected to a quantitative analysis of fluorine ions.

Eluting metal ion amount (Note 4) [ng/cm²]

Type	Al	Fe	Ni	Na	Ca
Eluting amount	4.5	0.3	0.2	7.1	1.3

The interior of the fluororesin tubing is washed with super deionized water. Approximately 20 g of super high purity hydrofluoric acid (48 %) is measured and injected into the tubing. The interior wall of the tubing is immersed at normal temperature for one week with both ends of the tubing plugged. Then the extract was diluted with super deionized water to be subjected to a quantitative analysis on Al, Fe, Ni, Na and Ca by the stripping method.

Note 4) Figures shown in tables are representative values, not guaranteed values.

Metric Sizes

Length per roll 10 m roll

O.D.	I.D.	Model
Ø 10	Ø 8	TL1008-10
Ø 12	Ø 10	TL1210-10
Ø 19	Ø 16	TL1916-10

Length per roll 20 m roll

O.D.	I.D.	Model
Ø 4	Ø 3	TL0403-20
Ø 6	Ø 4	TL0604-20
Ø 8	Ø 6	TL0806-20
Ø 10	Ø 8	TL1008-20
Ø 12	Ø 10	TL1210-20
Ø 19	Ø 16	TL1916-20

Length per roll 50 m roll

O.D.	I.D.	Model
Ø 4	Ø 3	TL0403-50
Ø 6	Ø 4	TL0604-50
Ø 8	Ø 6	TL0806-50
Ø 10	Ø 8	TL1008-50
Ø 12	Ø 10	TL1210-50
Ø 19	Ø 16	TL1916-50

Length per roll 100 m roll

O.D.	I.D.	Model
Ø 4	Ø 3	TL0403-100
Ø 6	Ø 4	TL0604-100
Ø 8	Ø 6	TL0806-100
Ø 10	Ø 8	TL1008-100
Ø 12	Ø 10	TL1210-100
Ø 19	Ø 16	TL1916-100

Straight 2 m

O.D.	I.D.	Model
Ø 4	Ø 3	TL0403-2S
Ø 6	Ø 4	TL0604-2S
Ø 8	Ø 6	TL0806-2S
Ø 10	Ø 8	TL1008-2S
Ø 12	Ø 10	TL1210-2S
Ø 19	Ø 16	TL1916-2S

Inch Sizes

Length per roll 10 m roll

O.D.	I.D.	Model
3/8"	1/4"	TIL11-10
1/2"	3/8"	TIL13-10

Length per roll 20 m roll

O.D.	I.D.	Model
1/8"	0.086"	TIL01-20
3/16"	1/8"	TIL05-20
1/4"	5/32"	TIL07-20
3/8"	1/4"	TIL11-20
1/2"	3/8"	TIL13-20
3/4"	5/8"	TIL19-20
1"	7/8"	TIL25-20

Length per roll 50 m roll

O.D.	I.D.	Model
1/8"	0.086"	TIL01-50
3/16"	1/8"	TIL05-50
1/4"	5/32"	TIL07-50
3/8"	1/4"	TIL11-50
1/2"	3/8"	TIL13-50
3/4"	5/8"	TIL19-50
1"	7/8"	TIL25-50

Length per roll 100 m roll

O.D.	I.D.	Model
1/8"	0.086"	TIL01-100
3/16"	1/8"	TIL05-100
1/4"	5/32"	TIL07-100
3/8"	1/4"	TIL11-100
1/2"	3/8"	TIL13-100
3/4"	5/8"	TIL19-100

Straight 2 m

O.D.	I.D.	Model
1/8"	0.086"	TIL01-2S
3/16"	1/8"	TIL05-2S
1/4"	5/32"	TIL07-2S
3/8"	1/4"	TIL11-2S
1/2"	3/8"	TIL13-2S
3/4"	5/8"	TIL19-2S
1"	7/8"	TIL25-2S

Length per roll 50 Ft (16 m) roll

O.D.	I.D.	Model
1/8"	0.086"	TIL01-16
	1/16"	TILB01-16
3/16"	1/8"	TIL05-16
1/4"	5/32"	TIL07-16
3/8"	1/4"	TIL11-16
1/2"	3/8"	TIL13-16
3/4"	5/8"	TIL19-16
1"	7/8"	TIL25-16

Length per roll 100 Ft (33 m) roll

O.D.	I.D.	Model
1/8"	0.086"	TIL01-33
	1/16"	TILB01-33
3/16"	1/8"	TIL05-33
1/4"	5/32"	TIL07-33
3/8"	1/4"	TIL11-33
1/2"	3/8"	TIL13-33
3/4"	5/8"	TIL19-33
1"	7/8"	TIL25-33

⚠ Precautions

Be sure to read this before handling. Refer to page 327 for Safety Instructions, pages 329 to 332 for Fittings and Tubing Precautions, and page 337 for Tubing Precautions.

- T
- TS
- TU
- TUS
- TUH
- TUZ
- TCU
- TFU
- TU/TUS
- TUZ
- IDK
- TRS
- TRB
- TRBU
- TRTU
- TQ
- TAS
- TAU
- TL/TIL
- TLM/TILM
- TH/TIH
- TD/TID
- TPH
- TPS
- Related

Fluoropolymer Tubing (PFA)

RoHS

TLM Series

■ Tubing size: Metric Size

Material: PFA

How to Order

Corrosion Resistant

Heat Resistant



Metric size

TLM0425 N - 20

Tubing model

Colour

Symbol	Colour
N	Translucent
R	Red (Translucent)
BU	Blue (Translucent)
B	Black (Opaque)

Length per roll

Symbol	Type	Length
10	Roll	10 m
20		20 m
50		50 m
100	Straight	100 m
2S		2 m

Note) Refer to the table "Series" above, as the tubing length differs depending on each size.

Model

Size			Metric size												
Model			TLM0201	TLM0302	TLM0425	TLM0403	TLM0604	TLM0806	TLM1075	TLM1008	TLM1209	TLM1210	TLM1613	TLM1916	TLM2522
Tubing size			Ø 2 x Ø 1	Ø 3 x Ø 2	Ø 4 x Ø 2.5	Ø 4 x Ø 3	Ø 6 x Ø 4	Ø 8 x Ø 6	Ø 10 x Ø 7.5	Ø 10 x Ø 8	Ø 12 x Ø 9	Ø 12 x Ø 10	Ø 16 x Ø 13	Ø 19 x Ø 16	Ø 25 x Ø 22
Tubing O.D. [mm]			2	3	4	4	6	8	10	10	12	12	16	19	25
Tubing I.D. [mm]			1	2	2.5	3	4	6	7.5	8	9	10	13	16	22
Length per roll	Colour	Symbol													
			TLM0201	TLM0302	TLM0425	TLM0403	TLM0604	TLM0806	TLM1075	TLM1008	TLM1209	TLM1210	TLM1613	TLM1916	TLM2522
Roll	10 m	Translucent	N												
		Translucent	N	●	●	●	●	●	●	●	●	●	●	●	●
	20 m	Red (Translucent)	R	●	●	●	●	●	●	●	●	●	●	●	●
		Blue (Translucent)	BU	●	●	●	●	●	●	●	●	●	●	●	●
		Black (Opaque)	B	●	●	●	●	●	●	●	●	●	●	●	●
50 m	Translucent	N	●	●	●	●	●	●	●	●	●	●	●	●	
	100 m	Translucent	N	●	●	●	●	●	●	●	●	●	●	●	
Straight	2 m	Translucent	N	●	●	●	●	●	●	●	●	●	●	●	

Inch O.D. size
5/32"

Inch O.D. size
5/16"

O.D. 3.2 mm is available in Ø 1/8 inch (3.18 mm) tubing. For details, refer to the table "Series" on page 301.

Specifications

Fluid (Note 1) (Note 2) (Note 3) and applicable fittings (Note 1) (Note 2) (Note 3)	Fluid: Refer to "Applicable Fluid List" on page 335. Fittings: Fluoropolymer fittings Series LQ Fluid: Air, Water, Inert gas Fittings: One-touch fittings KQ2, KQG2, Clean one-touch fittings KP, KP□ Insert fittings KF, KFG2, Miniature fittings M, MS (Hose nipple type)													
Max. operating pressure [MPa]	Refer to the max. operating pressure curve.													
Min. bending radius mm (Note 4)	Recommended radius	10	20	20	35	35	60	95	100	100	130	160	220	400
Max. operating temperature	Tube close bend radius	7	15	15	20	20	40	60	65	65	110	130	160	290
Material	260 °C PFA (Tetrafluoroethylene perfluoroalkoxy vinyl ether copolymer)													

Note 1) Fluid varies depending on the applicable fittings.

Note 2) When using a liquid fluid, the surge pressure must not exceed the maximum operating pressure. If the surge pressure exceeds the maximum operating pressure, it will result in damage to fittings and tubes. Furthermore, abnormal temperature rise caused by adiabatic compression may result in the tube bursting.

Note 3) Do not use this product in a manner in which the tube is not fixed. Observe the lesser value of the maximum operating pressure between the tubing and fitting. A material change over a long duration or due to high-temperature may cause leakage. Perform periodic maintenance and replace with a new product immediately when abnormalities are detected. (Refer to "Maintenance" of the tubing precautions on page 337). For other precautions, refer to "Fittings & Tubing Precautions" on pages 329 to 332. When using the fluoropolymer fittings, refer to the precautions on the WEB catalogue at www.smc.eu.

Note 4) The minimum bending radius is the representative value measured as shown in the right figure.

- Use a tube above the recommended minimum bending radius.
- The tube may be bent if used under the recommended minimum bending radius. Therefore, refer to the tube close bend radius and make sure that the tube is not bent or flattened.
- Please note that the tube close bend radius is not warranted because of the value when 2R is measured by the method in the right figure if the tubing is bent or flattened, etc.

How to measure the minimum bending radius.

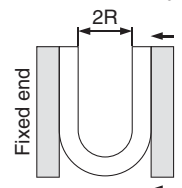

Bend the tube into the U-form at a temperature of 20 °C. Fix one end and close loop gradually. Measure 2R when the deformed ratio of the tube diameter at bending reaches 5 %.

Max. Operating Pressure

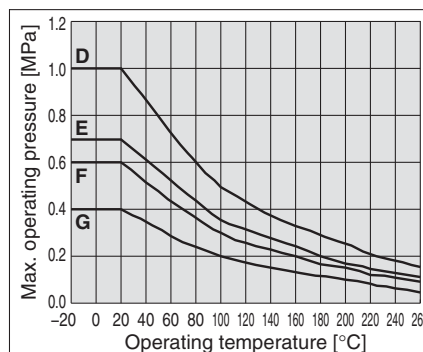
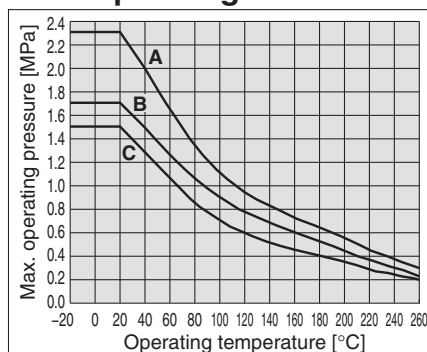

Group	Model	Max. operating pressure [MPa]			
		20 °C	100 °C	200 °C	260 °C
A	TLM0201	2.3	1.1	0.55	0.3
B	TLM0425	1.7	0.9	0.45	0.23
C	TLM0302	1.5	0.7	0.35	0.2
	TLM0604				
D	TLM0403	1	0.5	0.25	0.15
	TLM0806				
	TLM1075				
	TLM1209				
E	TLM1008	0.7	0.35	0.17	0.11
	TLM1613				
F	TLM1210	0.6	0.3	0.15	0.1
	TLM1916				
G	TLM2522	0.4	0.2	0.1	0.05

Metric Size
Length per roll 10 m roll

O.D.	I.D.	Colour (Symbol)	Model
Ø 10	Ø 7.5	Translucent (N)	TLM1075N-10
Ø 10	Ø 8		TLM1008N-10
Ø 12	Ø 9		TLM1209N-10
Ø 12	Ø 10		TLM1210N-10
Ø 16	Ø 13		TLM1613N-10
Ø 19	Ø 16		TLM1916N-10

Length per roll 20 m roll

O.D.	I.D.	Model
Ø 2	Ø 1	TLM0201 <small>Colour symbol</small> -20
Ø 3	Ø 2	TLM0302 <small>Colour symbol</small> -20
Ø 4	Ø 2.5	TLM0425 <small>Colour symbol</small> -20
Ø 4	Ø 3	TLM0403 <small>Colour symbol</small> -20
Ø 6	Ø 4	TLM0604 <small>Colour symbol</small> -20
Ø 8	Ø 6	TLM0806 <small>Colour symbol</small> -20
Ø 10	Ø 7.5	TLM1075 <small>Colour symbol</small> -20
Ø 10	Ø 8	TLM1008 <small>Colour symbol</small> -20
Ø 12	Ø 9	TLM1209 <small>Colour symbol</small> -20
Ø 12	Ø 10	TLM1210 <small>Colour symbol</small> -20
Ø 16	Ø 13	TLM1613 <small>Colour symbol</small> -20
Ø 19	Ø 16	TLM1916 <small>Colour symbol</small> -20
Ø 25	Ø 22	TLM2522 <small>Colour symbol</small> -20

Colour symbol -N: Translucent, R: Red/Translucent, BU: Blue/Translucent, B: Black/Opaque

Length per roll 50 m roll

O.D.	I.D.	Colour (Symbol)	Model
Ø 2	Ø 1	Translucent (N)	TLM0201N-50
Ø 3	Ø 2		TLM0302N-50
Ø 4	Ø 2.5		TLM0425N-50
Ø 4	Ø 3		TLM0403N-50
Ø 6	Ø 4		TLM0604N-50
Ø 8	Ø 6		TLM0806N-50
Ø 10	Ø 7.5		TLM1075N-50
Ø 10	Ø 8		TLM1008N-50
Ø 12	Ø 9		TLM1209N-50
Ø 12	Ø 10		TLM1210N-50
Ø 16	Ø 13		TLM1613N-50
Ø 19	Ø 16		TLM1916N-50
Ø 25	Ø 22		TLM2522N-50

Length per roll 100 m roll

O.D.	I.D.	Colour (Symbol)	Model
Ø 2	Ø 1	Translucent (N)	TLM0201N-100
Ø 3	Ø 2		TLM0302N-100
Ø 4	Ø 2.5		TLM0425N-100
Ø 4	Ø 3		TLM0403N-100
Ø 6	Ø 4		TLM0604N-100
Ø 8	Ø 6		TLM0806N-100
Ø 10	Ø 7.5		TLM1075N-100
Ø 10	Ø 8		TLM1008N-100
Ø 12	Ø 9		TLM1209N-100
Ø 12	Ø 10		TLM1210N-100
Ø 16	Ø 13		TLM1613N-100
Ø 19	Ø 16		TLM1916N-100

Straight 2 m

O.D.	I.D.	Colour (Symbol)	Model
Ø 2	Ø 1	Translucent (N)	TLM0201N-2S
Ø 3	Ø 2		TLM0302N-2S
Ø 4	Ø 2.5		TLM0425N-2S
Ø 4	Ø 3		TLM0403N-2S
Ø 6	Ø 4		TLM0604N-2S
Ø 8	Ø 6		TLM0806N-2S
Ø 10	Ø 7.5		TLM1075N-2S
Ø 10	Ø 8		TLM1008N-2S
Ø 12	Ø 9		TLM1209N-2S
Ø 12	Ø 10		TLM1210N-2S
Ø 16	Ø 13		TLM1613N-2S
Ø 19	Ø 16		TLM1916N-2S
Ø 25	Ø 22		TLM2522N-2S

⚠ Precautions

Be sure to read this before handling. Refer to page 327 for Safety Instructions, pages 329 to 332 for Fittings and Tubing Precautions, and page 337 for Tubing Precautions.

Fluoropolymer Tubing (PFA)

RoHS

TILM Series

■ Tubing size: Inch Size

Material: PFA



How to Order

Corrosion Resistant

Heat Resistant

Inch size

TILM01 N - 20

Tubing model

Colour

Symbol	Colour
N	Translucent
R	Red (Translucent)
BU	Blue (Translucent)
B	Black (Opaque)

Length per roll

Symbol	Type	Length
10	Roll	10 m
20		20 m
50		50 m
100		100 m
16		16 m (50 ft)
33		33 m (100 ft)
2S	Straight	2 m

Note) Refer to the table "Series" above, as the tubing length differs depending on each size.

Model

Size			Inch size									
Model			TILM01	TILMB01	TILM05	TILM07	TILM11	TILM13	TILM19	TILM25	TILM32	
Tubing size			1/8" x 0.086"	1/8" x 1/16"	3/16" x 1/8"	1/4" x 5/32"	3/8" x 1/4"	1/2" x 3/8"	3/4" x 5/8"	1" x 7/8"	1 1/4" x 1 1/10"	
Tubing O.D.	[inch]		1/8"	1/8"	3/16"	1/4"	3/8"	1/2"	3/4"	1"	1 1/4"	
	[mm]		3.18		4.75	6.35	9.53	12.7	19.05	25.4	31.75	
Tubing I.D.	[inch]		0.086"	1/16"	1/8"	5/32"	1/4"	3/8"	5/8"	7/8"	1 1/10"	
	[mm]		2.18	1.58	3.15	3.95	6.33	9.5	15.85	22.2	27.95	
Length per roll	10 m	Colour	Symbol									
	Roll	20 m	Translucent	N								
Red (Translucent)			R	●	●	●	●	●	●	●	●	
Blue (Translucent)			BU	●	●	●	●	●	●	●	●	
Black (Opaque)			B	●	●	●	●	●	●	●	●	
Roll	50 m	Translucent	N	●		●	●	●	●	●	●	
		Translucent	N	●		●	●	●	●	●	●	
		Translucent	N	●	●	●	●	●	●	●	●	
Roll	100 m	Translucent	N	●		●	●	●	●	●	●	
		Translucent	N	●	●	●	●	●	●	●	●	
		Translucent	N	●	●	●	●	●	●	●	●	
Roll	16 m (50 ft)	Translucent	N	●	●	●	●	●	●	●	●	
		Translucent	N	●	●	●	●	●	●	●	●	
Roll	33 m (100 ft)	Translucent	N	●	●	●	●	●	●	●	●	
		Translucent	N	●	●	●	●	●	●	●	●	
Straight	2 m	Translucent	N	●		●	●	●	●	●	●	
		Translucent	N	●		●	●	●	●	●	●	

Metric O.D. size
3.2

O.D. 5/32" is available in Ø4 metric tubing, and O.D. 5/16" is available in Ø8 metric tubing. For details, refer to the table "Series".

Specifications

Fluid (Note 1) (Note 2) (Note 3) and applicable fittings (Note 1) (Note 2) (Note 3)	Fluid: Refer to "Applicable Fluid List" on page 335. Fittings: Fluoropolymer fittings Series LQ
Max. operating pressure [MPa]	Fluid: Air, Water, Inert gas Fittings: One-touch fittings KQ2, KQG2, Insert fittings KFG2
Min. bending radius (mm) (Note 4)	Refer to the max. operating pressure curve
Max. operating temperature	260 °C
Material	PFA (Tetrafluoroethylene perfluoroalkoxy vinyl ether copolymer)

Note 1) Fluid varies depending on the applicable fittings.

Note 2) When using a liquid fluid, the surge pressure must not exceed the maximum operating pressure. If the surge pressure exceeds the maximum operating pressure, it will result in damage to fittings and tubes. Furthermore, abnormal temperature rise caused by adiabatic compression may result in the tube bursting.

Note 3) Do not use this product in a manner in which the tube is not fixed. Observe the lesser value of the maximum operating pressure between the tubing and fitting. A material change over a long duration or due to high-temperature may cause leakage. Perform periodic maintenance and replace with a new product immediately when abnormalities are detected. (Refer to "Maintenance" of the tubing precautions on page 337). For other precautions, refer to "Fittings & Tubing Precautions" on pages 329 to 332. When using the fluoropolymer fittings, refer to the precautions on the WEB catalogue at www.smc.eu.

Note 4) The minimum bending radius is the representative value measured as shown in the right figure.

- Use a tube above the recommended minimum bending radius.
- The tube may be bent if used under the recommended minimum bending radius. Therefore, refer to the tube close bend radius and make sure that the tube is not bent or flattened.
- Please note that the tube close bend radius is not warranted because of the value when 2R is measured by the method in the right figure if the tubing is bent or flattened, etc.

How to measure the minimum bending radius.

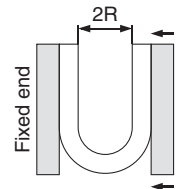

Bend the tube into the U-form at a temperature of 20 °C. Fix one end and close loop gradually. Measure 2R when the deformed ratio of the tube diameter at bending reaches 5%.

Max. Operating Pressure

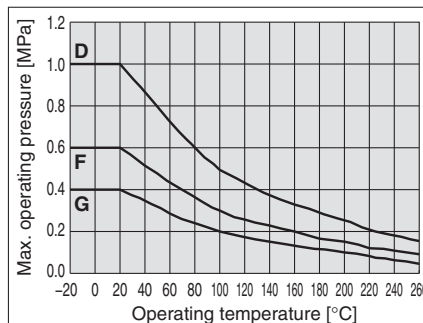
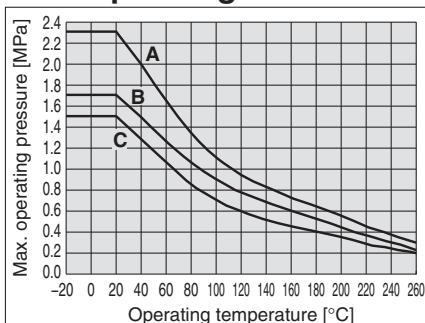

Group	Model	Max. operating pressure [MPa]			
		20 °C	100 °C	200 °C	260 °C
A	TILMB01	2.3	1.1	0.55	0.3
B	TILM07	1.7	0.9	0.45	0.23
C	TILM05	1.5	0.7	0.35	0.2
	TILM11				
D	TILM01	1	0.5	0.25	0.15
	TILM13				
F	TILM19	0.6	0.3	0.15	0.1
G	TILM25	0.4	0.2	0.1	0.05
	TILM32				

- T
- TS
- TU
- TUS
- TUH
- TUZ
- TCU
- TFU
- TU/TUS
- TUZ
- IDK
- TRS
- TRB
- TRBU
- TRTU
- TQ
- TAS
- TAU
- TL/TIL
- TLM/TILM
- TH/TIH
- TD/TID
- TPH
- TPS
- Related

Inch Size

Length per roll 10 m roll

O.D.	I.D.	Colour (Symbol)	Model
3/8"	1/4"	Translucent (N)	TILM11N-10
1/2"	3/8"		TILM13N-10

Length per roll 20 m roll

O.D.	I.D.	Model
1/8"	0.086"	TILM01 <small>Colour symbol</small> -20
1/8"	1/16"	TILMB01 <small>Colour symbol</small> -20
3/16"	1/8"	TILM05 <small>Colour symbol</small> -20
1/4"	5/32"	TILM07 <small>Colour symbol</small> -20
3/8"	1/4"	TILM11 <small>Colour symbol</small> -20
1/2"	3/8"	TILM13 <small>Colour symbol</small> -20
3/4"	5/8"	TILM19 <small>Colour symbol</small> -20
1"	7/8"	TILM25 <small>Colour symbol</small> -20
1 1/4"	1 1/10"	TILM32 <small>Colour symbol</small> -20

Colour symbol-N: Translucent, R: Red/Translucent, BU: Blue/Translucent, B: Black/Opaque

Length per roll 50 m roll

O.D.	I.D.	Colour (Symbol)	Model
1/8"	0.086"	Translucent (N)	TILM01N-50
3/16"	1/8"		TILM05N-50
1/4"	5/32"		TILM07N-50
3/8"	1/4"		TILM11N-50
1/2"	3/8"		TILM13N-50
3/4"	5/8"		TILM19N-50
1"	7/8"		TILM25N-50
1 1/4"	1 1/10"		TILM32N-50

Length per roll 100 m roll

O.D.	I.D.	Colour (Symbol)	Model
1/8"	0.086"	Translucent (N)	TILM01N-100
3/16"	1/8"		TILM05N-100
1/4"	5/32"		TILM07N-100
3/8"	1/4"		TILM11N-100
1/2"	3/8"		TILM13N-100
3/4"	5/8"		TILM19N-100

Straight 2 m

O.D.	I.D.	Colour (Symbol)	Model
1/8"	0.086"	Translucent (N)	TILM01N-2S
3/16"	1/8"		TILM05N-2S
1/4"	5/32"		TILM07N-2S
3/8"	1/4"		TILM11N-2S
1/2"	3/8"		TILM13N-2S
3/4"	5/8"		TILM19N-2S
1"	7/8"		TILM25N-2S
1 1/4"	1 1/10"		TILM32N-2S

Length per roll 50 Ft (16 m) roll

O.D.	I.D.	Colour (Symbol)	Model
1/8"	0.086"	Translucent (N)	TILM01N-16
1/8"	1/16"		TILMB01N-16
3/16"	1/8"		TILM05N-16
1/4"	5/32"		TILM07N-16
3/8"	1/4"		TILM11N-16
1/2"	3/8"		TILM13N-16
3/4"	5/8"		TILM19N-16
1"	7/8"		TILM25N-16
1 1/4"	1 1/10"		TILM32N-16

Length per roll 100 Ft (33 m) roll

O.D.	I.D.	Colour (Symbol)	Model
1/8"	0.086"	Translucent (N)	TILM01N-33
1/8"	1/16"		TILMB01N-33
3/16"	1/8"		TILM05N-33
1/4"	5/32"		TILM07N-33
3/8"	1/4"		TILM11N-33
1/2"	3/8"		TILM13N-33
3/4"	5/8"		TILM19N-33
1"	7/8"		TILM25N-33
1 1/4"	1 1/10"		TILM32N-33

⚠ Precautions

Be sure to read this before handling. Refer to page 327 for Safety Instructions, pages 329 to 332 for Fittings and Tubing Precautions, and page 337 for Tubing Precautions.

FEP Tubing (Fluoropolymer)

RoHS

TH/TH Series

■ Tubing size: Metric Size, Inch Size

Operating Temperature: Max.200 °C

It varies depending on the operating pressure. Refer to the graph for the maximum operating pressure.

Compatible with the Food Sanitation Law

- Compatible with the test conforming to the Food Sanitation Law based on the 370th notice given by the Ministry of Health and Welfare in 1959.
- Complies with FDA (Food and Drug Administration) §177-1550 dissolution test.



How to Order

Corrosion Resistant

Heat Resistant

Metric size

TH0604 N - 20

Inch size

TIHA01 N - 16

Tubing model

Colour

Symbol	Colour
N	Translucent
R	Red (Translucent)
BU	Blue (Translucent)
B	Black (Opaque)

Length per roll

Metric size

Symbol	Length
20	20 m roll
100 ^{Note)}	100 m roll

Note) 100 m roll is available with translucent (Colour indication: N) only.

Inch size

Symbol	Length
16	50 Ft (16 m) roll
33 ^{Note)}	100 Ft (33 m) roll

Note) 100 m roll is available with translucent (Colour indication: N) only.

Model

● -20 m roll □ -100 m roll

● -50 Ft (16 m) roll □ -100 Ft (33 m) roll

Model	Metric size								Inch size												
	TH0402	TH0425	TH0604	TH0806	TH1075	TH1008	TH1209	TH1210	TIHA01	TIHB01	TIHC01	TIHA05	TIHB05	TIHA07	TIHB07	TIHA11	TIHB11	TIH13	TIH19		
Tubing O.D.	—								1/8"		3/16"		1/4"		3/8"		1/2"		3/4"		
	—								3.18		4.75		6.35		9.53		12.7		19.05		
Tubing I.D.	—								0.093"	0.086"	0.065"	0.137"	0.124" (1/8")	0.18"	0.156" (5/32")	0.275"	0.25" (1/4")	0.374" (3/8")	0.624" (5/8")	—	
	—								2.36	2.18	1.65	3.48	3.15	4.57	3.95	6.99	6.33	9.5	15.85	—	
Translucent (N)	□	□	□	□	□	□	□	□	□	□	□	□	□	□	□	□	□	□	□		
Red (Translucent) (R)	●	●	●	●	●	●	●	●	●	●	●	●	●	●	●	●	●	●	●		
Blue (Translucent) (BU)	●	●	●	●	●	●	●	●	●	●	●	●	●	●	●	●	●	●	●		
Black (Opaque) (B)	●	●	●	●	●	●	●	●	●	●	●	●	●	●	●	●	●	●	●		
	Inch nominal size 5/32"				Inch nominal size 5/16"																

Specifications

Applicable fluid	Refer to "Applicable Fluid List" on page 336.									Refer to "Applicable Fluid List" on page 336.									
Fluid	Air, Water ^{Note 1)} , Inert gas									Air, Water ^{Note 1)} , Inert gas									
Applicable fittings ^{Note 2)}	One-touch fittings, Insert fittings Fluoropolymer fittings: Series LQ Miniature fittings: Series M, MS (Hose nipple type)									One-touch fittings Fluoropolymer fittings: Series LQ									
Max. operating pressure [MPa]	20 °C	2.3	1.7	1.5	1	0.7	1	0.7	1	2.3	1	1.5	1	1.7	1	1.5	1	0.7	
	100 °C	0.85	0.6	0.55	0.4	0.25	0.4	0.25	0.4	0.85	0.4	0.55	0.4	0.6	0.4	0.55	0.4	0.25	
	200 °C	0.4	0.3	0.3	0.2	0.1	0.2	0.1	0.2	0.4	0.2	0.3	0.2	0.3	0.2	0.3	0.2	0.1	
Min. bending radius [mm] ^{Note 3)}	Recommended radius	15	20	35	60	95	100	130	25	20	10	35	25	55	35	85	60	95	220
	Tube close bend radius	10	15	20	40	60	65	110	20	12	7	25	20	35	20	55	30	60	160
Operating temperature	Air, Inert gas: -20 to 200 °C Water: 0 to 100 °C (No freezing)																		
Material	FEP (Fluorinated Ethylene Propylene Resin)																		

Note 1) When using a fluid in liquid form, the surge pressure must not exceed the maximum operating pressure. A surge pressure higher than the maximum operating pressure can cause breakage of the fittings, or rupture of the tubing. Furthermore, an abnormal temperature increase due to adiabatic compression can also result in ruptured tubing.

Note 2) Do not use in locations where the FEP tubing will move. Be sure to operate under the maximum operating pressure conditions using the lower maximum operating specification of either the tubing or fittings. After long term use or under high temperatures, some fittings leakage may occur due to material deterioration with age. Perform periodic inspections, and if any leakage is detected, replace with a new product immediately.

When the insert and miniature fittings are used over extended periods of time, it may cause leakage due to the material deterioration of age. In such a case, give an additional tightening to the tube connection part. If leakage still occurs after giving an additional tightening, replace the fitting with a new product.

For other precautions, refer to "Fittings & Tubing Precautions" on pages 329 to 332. When using fluoropolymer fittings, refer to the precautions in the **WEB catalogue** at www.smc.eu. Also, please select an applicable tubing size while carefully checking the O.D. and I.D. sizes.

Note 3) The minimum bending radius is the representative value measured as shown in the next page.

- Use a tube above the recommended minimum bending radius.
- The tube may be bent if used under the recommended minimum bending radius. Therefore, refer to the tube close bend radius and make sure that the tube is not bent or flattened.
- Please note that the tube close bend radius is not warranted because of the value when 2R is measured by the method in the next page if the tubing is bent or flattened, etc.

Metric Size

Inch Size

Length per roll 20 m roll

Length per roll 50 Ft (16 m) roll

Max. Operating Pressure

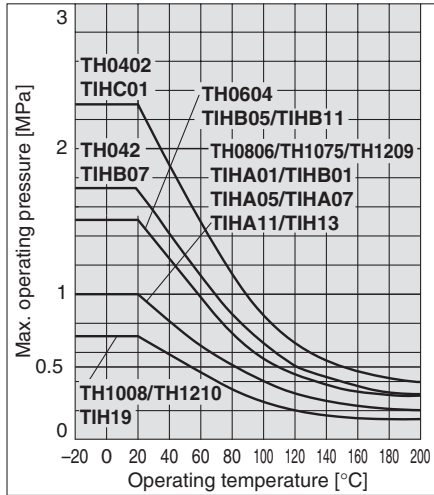

Note) The maximum operating pressure varies dependant on the I.D. bore size even if the O.D. is the same.

O.D.	I.D.	Colour (Symbol)	Model	
Ø 4	Ø 2	Translucent (N)	TH0402 [Colour symbol]-20	
		Red (R)		
		Blue (BU)		
	Ø 2.5	Black (B)		
		Translucent (N)		
		Red (R)		
Ø 6	Ø 4	Blue (BU)	TH0425 [Colour symbol]-20	
		Black (B)		
		Translucent (N)		
	Ø 6	Red (R)		TH0604 [Colour symbol]-20
		Blue (BU)		
		Black (B)		
Ø 8	Ø 6	Translucent (N)	TH0806 [Colour symbol]-20	
		Red (R)		
		Blue (BU)		
	Ø 7.5	Black (B)		TH1075 [Colour symbol]-20
		Translucent (N)		
		Red (R)		
Ø 10	Ø 8	Blue (BU)	TH1008 [Colour symbol]-20	
		Black (B)		
		Translucent (N)		
	Ø 9	Red (R)		TH1209 [Colour symbol]-20
		Blue (BU)		
		Black (B)		
Ø 12	Ø 10	Translucent (N)	TH1210 [Colour symbol]-20	
		Red (R)		
		Blue (BU)		
	Ø 10	Black (B)		
		Translucent (N)		
		Red (R)		

O.D.	I.D.	Colour (Symbol)	Model	
1/8"	0.093"	Translucent (N)	TIHA01 [Colour symbol]-16	
		Red (R)		
		Blue (BU)		
	0.086"	Black (B)		TIHB01 [Colour symbol]-16
		Translucent (N)		
		Red (R)		
3/16"	0.065"	Blue (BU)	TIHC01 [Colour symbol]-16	
		Black (B)		
		Translucent (N)		
	0.137"	Red (R)		TIHA05 [Colour symbol]-16
		Blue (BU)		
		Black (B)		
1/4"	0.124" (1/8")	Translucent (N)	TIHB05 [Colour symbol]-16	
		Red (R)		
		Blue (BU)		
	0.18"	Black (B)		TIHA07 [Colour symbol]-16
		Translucent (N)		
		Red (R)		
3/8"	0.156" (5/32")	Blue (BU)	TIHB07 [Colour symbol]-16	
		Black (B)		
		Translucent (N)		
	0.275"	Red (R)		TIHA11 [Colour symbol]-16
		Blue (BU)		
		Black (B)		
1/2"	0.25" (1/4")	Translucent (N)	TIHB11 [Colour symbol]-16	
		Red (R)		
		Blue (BU)		
	0.374" (3/8")	Black (B)		TIH13 [Colour symbol]-16
		Translucent (N)		
		Red (R)		
3/4"	0.624" (5/8")	Blue (BU)	TIH19 [Colour symbol]-16	
		Black (B)		
		Translucent (N)		

Red and blue are translucent. Black is opaque.

Red and blue are translucent. Black is opaque.

Length per roll 100 m roll

Length per roll 100 Ft (33 m) roll

O.D.	I.D.	Colour (Symbol)	Model
Ø 4	Ø 2	Translucent (N)	TH0402N-100
	Ø 2.5		TH0425N-100
Ø 6	Ø 4		TH0604N-100
	Ø 6		TH0806N-100
Ø 10	Ø 7.5		TH1075N-100
	Ø 8		TH1008N-100
Ø 12	Ø 9		TH1209N-100
	Ø 10		TH1210N-100

O.D.	I.D.	Colour (Symbol)	Model
1/8"	0.093"	Translucent (N)	TIHA01N-33
	0.086"		TIHB01N-33
	0.065"		TIHC01N-33
3/16"	0.137"		TIHA05N-33
	0.124" (1/8")		TIHB05N-33
1/4"	0.18"		TIHA07N-33
	0.156" (5/32")		TIHB07N-33
3/8"	0.275"		TIHA11N-33
	0.25" (1/4")		TIHB11N-33
1/2"	0.374" (3/8")	TIH13N-33	
3/4"	0.624" (5/8")	TIH19N-33	

Made to Order

1 Reinforced Corrugated Cardboard Specification/Longer Length Reel X64

O.D.	I.D.	Model	Length per roll
Ø 6	Ø 4	TH0604N-250-X64	250
		TH0604N-500-X64	500

N: Translucent

⚠ Precautions

Be sure to read this before handling. Refer to page 327 for Safety Instructions, pages 329 to 332 for Fittings and Tubing Precautions, and page 337 for Tubing Precautions.

How to measure the minimum bending radius.

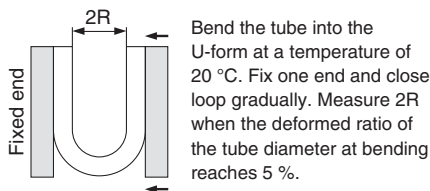

Soft Fluoropolymer Tubing

RoHS

TD/TID Series

■ Tubing size: Metric Size, Inch Size

Flexibility: Improved by approx. 20 %

* SMC comparison (Fluoropolymer tubing, Series TL/TIL)

**Applications: Food, Semiconductor
Medical, Automobile
Machine tools**

Compatible with the Food Sanitation Law

- Compatible with the test conforming to the Food Sanitation Law based on the 370th notice given by the Ministry of Health and Welfare in 1959.
- Complies with FDA (Food and Drug Administration) §177-1550 dissolution test.



How to Order

Corrosion Resistant

Heat Resistant

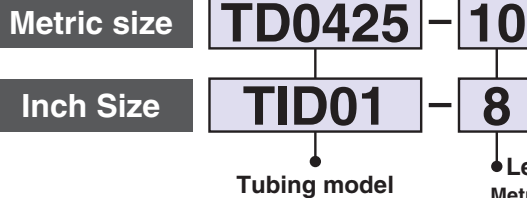

● Length per roll

Symbol	Length
10	10 m roll
20	20 m roll

Inch size

Symbol	Length
8	25 Ft (8 m) roll
16	50 Ft (16 m) roll

Model

● -10 m roll □ -20 m roll ● -25 Ft (8 m) roll □ -50 Ft (16 m) roll

Model	Tubing size					Tubing size					
	Metric size					Inch size					
	TD0425	TD0604	TD0806	TD1075	TD1209	TID01	TID05	TID07	TID11	TID13	
Tubing O.D.	[inch]	—					1/8"	3/16"	1/4"	3/8"	1/2"
	[mm]	4	6	8	10	12	3.18	4.75	6.35	9.53	12.7
Tubing I.D.	[inch]	—					0.086"	0.124"	0.156"	0.25"	0.374"
	[mm]	2.5	4	6	7.5	9	2.18	3.15	3.95	6.33	9.5
Translucent (Material colour)	●	□	●	□	●	□	●	□	●	□	

Specifications

Applicable fluid	Refer to the applicable fluid in page 234.					Refer to the applicable fluid in page 234.					
Fluid	Air, Water ^{Note 1)} , Inert gas					Air, Water ^{Note 1)} , Inert gas					
Applicable fittings ^{Note 2)}	Insert Fittings Miniature fittings M, MS series (Hose nipple type) Fluoropolymer fitting series LQ					Fluoropolymer fitting series LQ					
Max. operating pressure [MPa]	20 °C	1.6	1.4	0.9	0.9	0.9	1.4	1.4	1.6	1.4	0.9
	100 °C	0.9	0.7	0.5	0.5	0.5	0.7	0.7	0.9	0.7	0.5
	200 °C	0.45	0.35	0.25	0.25	0.25	0.35	0.35	0.45	0.35	0.25
	260 °C	0.23	0.2	0.15	0.15	0.15	0.2	0.2	0.23	0.2	0.15
Min. bending radius ^{Note 3)} [mm]	Recommended radius	15	25	45	55	75	15	20	25	40	75
	Tube close bend radius	8	16	31	35	41	9	10	15	23	42
Max. operating temperature (fixed usage)	260 °C					260 °C					
Material	Modified PTFE (Polytetrafluoroethylene resin)					Modified PTFE (Polytetrafluoroethylene resin)					

Note 1) When using a liquid fluid, the surge pressure must be under the maximum operating pressure. If the surge pressure exceeds the maximum operating pressure, it will result in damage to fittings and tubing. Furthermore, abnormal temperature rise caused by adiabatic compression may result in the tubing bursting.

Note 2) Do not use this product in a manner in which the tubing is not fixed. Observe the lesser value of the maximum operating pressure between the tubing and fittings. A material change over a long duration or due to high-temperature may cause leakage. Perform periodic maintenance and replace with a new product immediately when abnormalities are detected. (Refer to "Maintenance" of the tubing precautions on page 337).

For other precautions, refer to "Fittings & Tubing Precautions" on pages 329 to 332. When using the fluoropolymer fittings, refer to the precautions on the **WEB catalogue** at www.smc.eu.

Note 3) The minimum bending radius is the representative value measured as shown in the left figure.

- Use a tube above the recommended minimum bending radius.
- The tube may be bent if used under the recommended minimum bending radius. Therefore, refer to the tube close bend radius and make sure that the tube is not bent or flattened.
- Please note that the tube close bend radius is not warranted because of the value when 2R is measured by the method in the left figure if the tubing is bent or flattened, etc.

⚠ Precautions

Be sure to read this before handling. Refer to page 327 for Safety Instructions, pages 329 to 332 for Fittings and Tubing Precautions, and page 337 for Tubing Precautions.

How to measure the minimum bending radius.

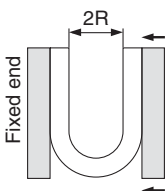

Bend the tube into the U-form at a temperature of 20 °C. Fix one end and close loop gradually. Measure 2R when the deformed ratio of the tube diameter at bending reaches 5 %.

Max. Operating Pressure

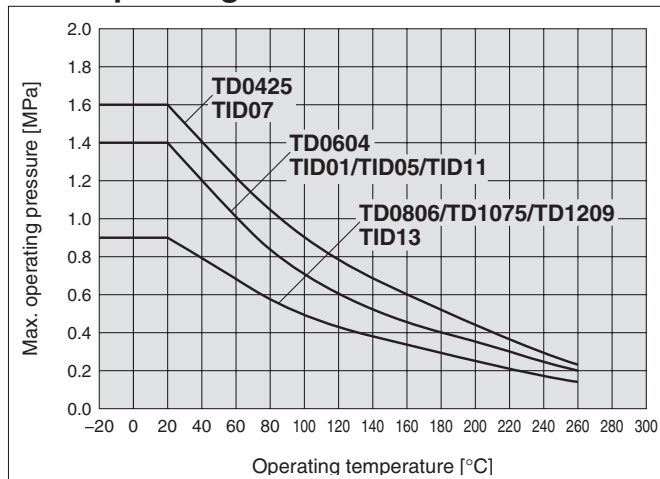

Eluting Fluorine Ion Amount ^{Note 4)} [$\mu\text{g/g}$]

Type	Fluorine ion
Eluting amount	0.7

A 15 g piece of fluororesin tubing is cut off, washed in DI water (pure water) and immersed in 15 ml of 25 % methyl alcohol extract at room temperature for 24 hours. Then the extract is diluted with DI water (pure water) to be subjected to a quantitative analysis of fluorine ions.

Eluting Metal Ion Amount ^{Note 4)} [ng/cm^2]

Type	Al	Fe	Ni	Na	Ca
Eluting amount	0.1 or less	0.1 or less	0.1 or less	0.1	0.1 or less

The interior of the fluororesin tubing is washed with super deionized water. Approximately 20 g of super high purity hydrofluoric acid (48 %) is measured and injected into the tubing. The interior wall of the tubing is immersed at normal temperature for one week with both ends of the tubing plugged. Then the extract was diluted with super deionized water to be subjected to a quantitative analysis on Al, Fe, Ni, Na and Ca by the stripping method.

Note 4) Figures shown in tables are representative values, not guaranteed values.

Metric Sizes

Length per roll 10 m roll

O.D.	I.D.	Colour	Model
Ø 4	Ø 2.5	Translucent (Material colour)	TD0425-10
Ø 6	Ø 4		TD0604-10
Ø 8	Ø 6		TD0806-10
Ø 10	Ø 7.5		TD1075-10
Ø 12	Ø 9		TD1209-10

Length per roll 20 m roll

O.D.	I.D.	Colour	Model
Ø 4	Ø 2.5	Translucent (Material colour)	TD0425-20
Ø 6	Ø 4		TD0604-20
Ø 8	Ø 6		TD0806-20
Ø 10	Ø 7.5		TD1075-20
Ø 12	Ø 9		TD1209-20

Inch Sizes

Length per roll 25 Ft (8 m) roll

O.D.	I.D.	Colour	Model
1/8"	0.086"	Translucent (Material colour)	TID01-8
3/16"	0.124" (1/8")		TID05-8
1/4"	0.156" (5/32")		TID07-8
3/8"	0.25" (1/4")		TID11-8
1/2"	0.374" (3/8")		TID13-8

Length per roll 50 Ft (16 m) roll

O.D.	I.D.	Colour	Model
1/8"	0.086"	Translucent (Material colour)	TID01-16
3/16"	0.124" (1/8")		TID05-16
1/4"	0.156" (5/32")		TID07-16
3/8"	0.25" (1/4")		TID11-16
1/2"	0.374" (3/8")		TID13-16

- T
- TS
- TU
- TUS
- TUH
- TUZ
- TCU
- TFU
- TU/TUS
- TUZ
- IDK
- TRS
- TRB
- TRBU
- TRTU
- TQ
- TAS
- TAU
- TL/TIL
- TLM/TILM
- TH/THH
- TD/TID
- TPH
- TPS
- Related

Clean



How to Order

TPH0604 B - 20

Tubing model

Colour

Length per roll

Symbol	Colour
W	White
B	Black
R	Red
BU	Blue
Y	Yellow
G	Green

Symbol	Length
20	20 m roll
100	100 m roll

Burst Pressure Characteristics Curve and Operating Pressure

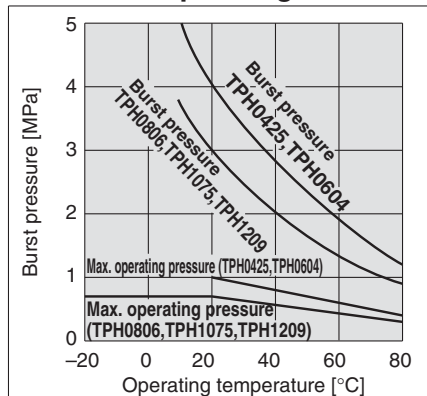

Model

● - 20 m roll □ - 100 m roll

Model	Tubing size				
	Metric sizes				
	TPH0425	TPH0604	TPH0806	TPH1075	TPH1209
Tubing O.D. [mm]	4	6	8	10	12
Tubing I.D. [mm]	2.5	4	6	7.5	9
White (W)	●	□	●	□	●
Black (B)	●	□	●	□	●
Red (R)	●	□	●	□	●
Blue (BU)	●	□	●	□	●
Yellow (Y)	●	□	●	□	●
Green (G)	●	□	●	□	●

Specifications

Fluid	Air / Nitrogen gas / Water (Pure water) ^{Note 1)}				
Max. operating pressure (at 20 °C)	1 MPa ^{Note 2)}		0.7 MPa ^{Note 2)}		
Min. bending radius [mm]	15	25	35	45	55
Burst pressure	Refer to the burst pressure characteristics curve.				
Applicable fittings	Clean One-touch fittings One-touch fittings, Metal: Series KQB2 One-touch fittings, Stainless steel 316: Series KQG2 Insert fittings				
Operating temperature	-20 to 80 °C, For water 5 to 80 °C				
Material	Polyolefin resin				

Note 1) Please consult with SMC regarding other fluids.

Note 2) The maximum operating pressure is the value at 20 °C. Refer to the burst pressure characteristics curve for other temperatures. Furthermore, an abnormal temperature rise due to adiabatic compression can cause tubing to burst.

Note 3) The minimum bending radius indicates the value at a temperature of 20 °C with an outside diameter rate of change of 10 % or less. At higher temperatures the outside diameter rate of change may exceed 10 % within the minimum bending radius.

Note 4) Polyolefin resin is not suitable for regular pneumatic equipment piping because it is not resistant to mineral oil.

Length per roll **20** m roll

O.D.	I.D.	Colour (Symbol)	Model
Ø 4	Ø 2.5	White (W)	TPH0425 [Colour symbol]-20
		Black (B)	
		Red (R)	
		Blue (BU)	
		Yellow (Y)	
Ø 6	Ø 4	White (W)	TPH0604 [Colour symbol]-20
		Black (B)	
		Red (R)	
		Blue (BU)	
		Yellow (Y)	
Ø 8	Ø 6	White (W)	TPH0806 [Colour symbol]-20
		Black (B)	
		Red (R)	
		Blue (BU)	
		Yellow (Y)	
Ø 10	Ø 7.5	White (W)	TPH1075 [Colour symbol]-20
		Black (B)	
		Red (R)	
		Blue (BU)	
		Yellow (Y)	
Ø 12	Ø 9	White (W)	TPH1209 [Colour symbol]-20
		Black (B)	
		Red (R)	
		Blue (BU)	
		Yellow (Y)	
		Green (G)	

Length per roll **100** m roll

O.D.	I.D.	Colour (Symbol)	Model
Ø 4	Ø 2.5	White (W)	TPH0425 [Colour symbol]-100
		Black (B)	
		Red (R)	
		Blue (BU)	
		Yellow (Y)	
Ø 6	Ø 4	White (W)	TPH0604 [Colour symbol]-100
		Black (B)	
		Red (R)	
		Blue (BU)	
		Yellow (Y)	
Ø 8	Ø 6	White (W)	TPH0806 [Colour symbol]-100
		Black (B)	
		Red (R)	
		Blue (BU)	
		Yellow (Y)	
Ø 10	Ø 7.5	White (W)	TPH1075 [Colour symbol]-100
		Black (B)	
		Red (R)	
		Blue (BU)	
		Yellow (Y)	
Ø 12	Ø 9	White (W)	TPH1209 [Colour symbol]-100
		Black (B)	
		Red (R)	
		Blue (BU)	
		Yellow (Y)	
		Green (G)	

- T
- TS
- TU
- TUS
- TUH
- TUZ
- TCU
- TFU
- TU/TUS
- TUZ
- IDK
- TRS
- TRB
- TRBU
- TRTU
- TQ
- TAS
- TAU
- TL/TIL
- TLM/TILM
- TH/TIH
- TD/TID
- TPH**
- TPS
- Related

Clean Tubing: Soft Polyolefin Tubing

RoHS

TPS Series

■ Tubing size: Metric Size

Clean



How to Order

TPS0604 B-20

Tubing model

Colour

Length per roll

Symbol	Colour
W	White
B	Black
R	Red
BU	Blue
Y	Yellow
G	Green

Symbol	Length
20	20 m roll
100	100 m roll

Burst Pressure Characteristics Curve and Operating Pressure

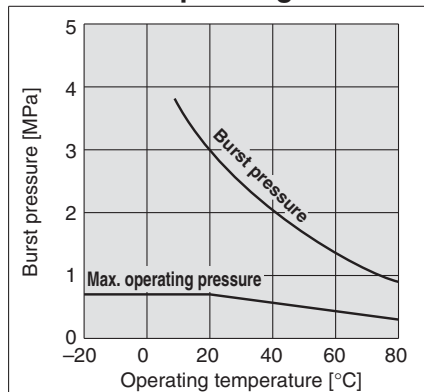

Model

● -20 m roll □ -100 m roll

Model	Tubing size				
	Metric sizes				
	TPS0425	TPS0604	TPS0805	TPS1065	TPS1208
Tubing O.D. [mm]	4	6	8	10	12
Tubing I.D. [mm]	2.5	4	5	6.5	8
White (W)	●	□	●	□	●
Black (B)	●	□	●	□	●
Red (R)	●	□	●	□	●
Blue (BU)	●	□	●	□	●
Yellow (Y)	●	□	●	□	●
Green (G)	●	□	●	□	●

Specifications

Fluid	Air/Nitrogen gas/Water (Pure water) ^{Note 1)}				
Max. operating pressure (at 20 °C)	0.7 MPa ^{Note 2)}				
Min. bending radius [mm]	10	20	25	30	40
Burst pressure	Refer to the burst pressure characteristics curve.				
Applicable fittings	Clean One-touch fittings One-touch fittings, Metal: Series KQB2 One-touch fittings, Stainless steel 316: Series KQG2 Insert fittings				
Operating temperature	-20 to 80 °C, For water 5 to 80 °C				
Material	Polyolefin resin				

Note 1) Please consult with SMC regarding other fluids.

Note 2) The maximum operating pressure is the value at 20 °C. Refer to the burst pressure characteristics curve for other temperatures. Furthermore, an abnormal temperature rise due to adiabatic compression can cause tubing to burst.

Note 3) The minimum bending radius indicates the value at a temperature of 20 °C with an outside diameter rate of change of 10 % or less. At higher temperatures the outside diameter rate of change may exceed 10 % within the minimum bending radius.

Note 4) Polyolefin resin is not suitable for regular pneumatic equipment piping because it is not resistant to mineral oil.

Length per roll **20** m roll

O.D.	I.D.	Colour (Symbol)	Model
Ø 4	Ø 2.5	White (W)	TPS0425 Colour symbol -20
		Black (B)	
		Red (R)	
		Blue (BU)	
		Yellow (Y)	
Ø 6	Ø 4	White (W)	TPS0604 Colour symbol -20
		Black (B)	
		Red (R)	
		Blue (BU)	
		Yellow (Y)	
Ø 8	Ø 5	White (W)	TPS0805 Colour symbol -20
		Black (B)	
		Red (R)	
		Blue (BU)	
		Yellow (Y)	
Ø 10	Ø 6.5	White (W)	TPS1065 Colour symbol -20
		Black (B)	
		Red (R)	
		Blue (BU)	
		Yellow (Y)	
Ø 12	Ø 8	White (W)	TPS1208 Colour symbol -20
		Black (B)	
		Red (R)	
		Blue (BU)	
		Yellow (Y)	
		Green (G)	

Length per roll **100** m roll

O.D.	I.D.	Colour (Symbol)	Model
Ø 4	Ø 2.5	White (W)	TPS0425 Colour symbol -100
		Black (B)	
		Red (R)	
		Blue (BU)	
		Yellow (Y)	
Ø 6	Ø 4	White (W)	TPS0604 Colour symbol -100
		Black (B)	
		Red (R)	
		Blue (BU)	
		Yellow (Y)	
Ø 8	Ø 5	White (W)	TPS0805 Colour symbol -100
		Black (B)	
		Red (R)	
		Blue (BU)	
		Yellow (Y)	
Ø 10	Ø 6.5	White (W)	TPS1065 Colour symbol -100
		Black (B)	
		Red (R)	
		Blue (BU)	
		Yellow (Y)	
Ø 12	Ø 8	White (W)	TPS1208 Colour symbol -100
		Black (B)	
		Red (R)	
		Blue (BU)	
		Yellow (Y)	
		Green (G)	

- T
- TS
- TU
- TUS
- TUH
- TUZ
- TCU
- TFU
- TU/TUS
- TUZ
- IDK
- TRS
- TRB
- TRBU
- TRTU
- TQ
- TAS
- TAU
- TL/TIL
- TLM/TILM
- TH/TIH
- TD/TID
- TPH
- TPS**
- Related

Multi-tube Holder

RoHS **TM Series**

Possible to separate options depending on number of connection tubes
Use of flame resistant resin (Equivalent to UL-94 standard V-0)



Model

Applicable tubing O.D. [mm]	Model	No. of connecting tubes (MAX.)			Accessory	
		6	8	12	For mounting	
					Size (Nominal x Length)	No. of tubings
4	TM-04			●	2 x 6	4
6	TM-06			●	2.6 x 8	
8	TM-08		●			
10	TM-10	●			3 x 8	
12	TM-12	●				

How to Use

⚠ Caution

1. Cut the multi-tube holder depending on number of tubes to be connected.

<Cutting method>
Cut the groove for separation with side cutters.



2. Install the multi-tube holder to the equipment with cross-recessed head, countersunk tapping screw.
3. Lay the tube across the gripper and push on the tube.
4. For removing the tubes, pull up the tubes from the gripper.

Tube Cutter

RoHS **TK Series**

TK-1 Applicable tubing O.D.: 13 mm or less



TK-2 Applicable tubing O.D.: 18 mm or less



TK-3 (Useful type) Applicable tubing O.D.: 12 mm or less



Note) Do not use it to cut the metallic materials such as electric wires.

TK-6 Applicable tubing O.D.: 16 mm or less



Tube Releasing Tool

RoHS **TG Series**

Removal of the tube in a narrow space or the tube of the manifold One-touch fittings

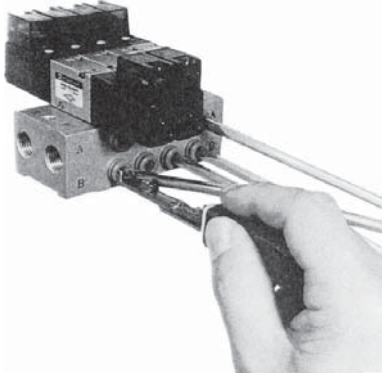

Model	TG-1
Applicable tubing size	Ø 4, Ø 6
Applicable tubing material	Nylon, Soft nylon, Polyurethane
Colour	Blue
Weight	33 g

Tube Stand & Tube Reel

RoHS **TB/TBR Series**

- Compact size without taking up space
- Easy installment just by putting tube reel

- Allows easy refilling and replacing tubes.

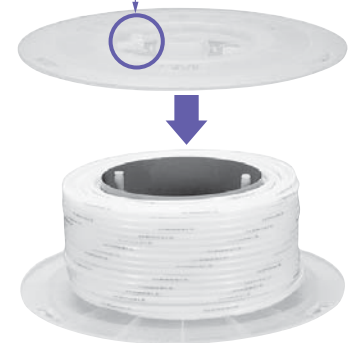
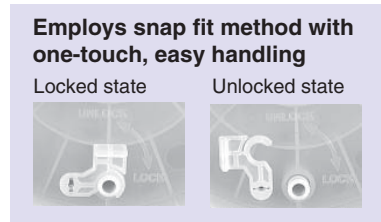
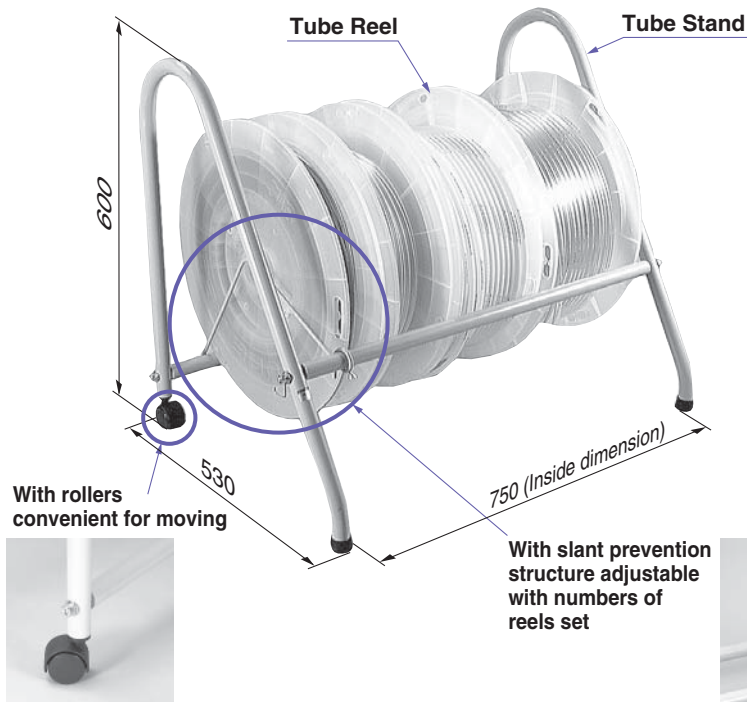

Tube Reel

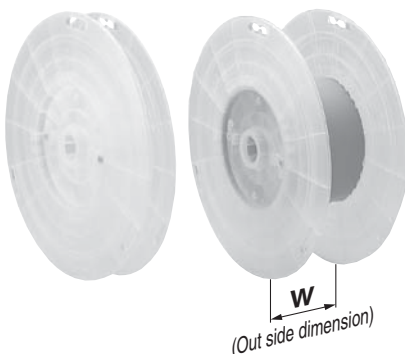

Applicable tubing size [mm]	Model	W [mm]
4, 6	TBR-1	110
8	TBR-2	140
10	TBR-3	190
12	TBR-4	240

Tube Stand: TB-2

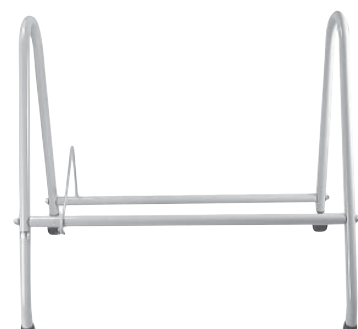

T
TS
TU
TUS
TUH
TUZ
TCU
TFU
TU/TUS
TUZ
IDK
TRS
TRB
TRBU
TRTU
TQ
TAS
TAU
TL/
TIL
TLM/
TILM
TH/
TIH
TD/
TID
TPH
TPS
Related

Blow Guns

Blow Guns

Blow Guns VMG Series



317

Nozzles for Blowing KN Series

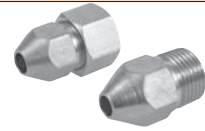

320

VMG

KN

AN

Silencers

Silencers

Series	Port size											Page	
	M3	M5	1/8	1/4	3/8	1/2	3/4	1	1 1/4	1 1/2	2		
Compact Resin Type/Male Thread AN05 to 40 Series Compact, Lightweight Noise reduction: 30 dB(A)		●	●	●	●	●							321
Compact Resin Type/One-touch Fitting Connection AN10 to 30-C Series Can connect with One-touch fitting directly. Noise reduction: 30 dB(A)			Ø 6 Ø 1/4	Ø 8 Ø 10 Ø 3/8	Ø 12								321
Metal Body Type AN□00 Series Low back pressure, Easy mounting. Noise reduction: 30 dB(A)							●	●	●	●	●		322
Metal Case Type 25□□ Series Prevents scattering of mist and noise. Noise reduction: 19 dB(A)				●	●	●	●	●					322
BC Sintered Body Type AN Series Noise reduction: 13, 16, 18, 21 dB(A) Ambient and fluid temperature: 5 to 150 °C	●	●	●										323
High Noise Reduction Type AN□02 Series Uses a flame resistant material for the case. Noise reduction: 35 dB(A)				●	●	●							323
High Noise Reduction Type ANA1 Series Keeps the in-plant noise level below 85 dB(A). Noise reduction: 40 dB(A)			●	●	●	●	●	●	●	●	●	●	324
High Noise Reduction Type ANB1 Series Has a larger effective area than the ANA1 series, but with the same port size. Noise reduction: 38 dB(A)			●	●	●	●	●	●	●	●	●	●	324

VMG Series

Energy saving of the air blow is possible.

- 20% reduction in power consumption

* For details, refer to the WEB catalogue on www.smc.eu.

- Pressure loss 1 % or less (Nozzle size: Ø 2.5)

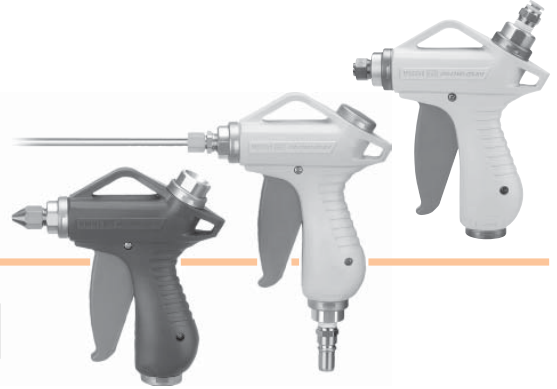

How to Order

VMG 1 1 W - 02 - 32 - C

• Piping entry

1	Bottom
2	Top

• Body colour

W	White
BU	Dark blue

• Connection size

Symbol	Piping connection method	Size and model no.	
02	Threaded	Thread size	Rc 1/4
03			Rc 3/8
N02			NPT 1/4
N03			NPT 3/8
F02			G 1/4
F03			G 3/8
11			S coupler
12	plug	Model no. of fitting used	KK130P-02MS
H06	Metric size	Model no. of fitting used	KQ2H06-02S
H08	One-touch fitting	Model no. of fitting used	KQ2H08-02S
H10	One-touch fitting	Model no. of fitting used	KQ2H10-02S
H07	Inch size	Model no. of fitting used	KQ2H07-35S
H09	One-touch fitting	Model no. of fitting used	KQ2H09-35S
H11	One-touch fitting	Model no. of fitting used	KQ2H11-35S

Note 1) S coupler and fitting are included in the same package.

Note 2) Port size is Rc 1/4 if using the S coupler plug.

Note 3) The blow gun port size is Rc 1/4 if using the metric size One-touch fitting.

Note 4) The blow gun port size is NPT 1/4 if using the inch size One-touch fitting.

• With nozzle cover (Only for male thread nozzle, Ø 6 extension nozzle)

—	None
C	With nozzle cover/HNBR
CF	With nozzle cover/Fluororubber

• Nozzle

Symbol	Type	Nozzle size	Nozzle part no.
—	Without nozzle		
01	Male thread nozzle	Ø 1	KN-R02-100
02		Ø 1.5	KN-R02-150
03		Ø 2	KN-R02-200
04		Ø 2.5	KN-R02-250
05		Ø 3	VMG1-R02-300
06		Ø 3.5	VMG1-R02-350
07		Ø 4	VMG1-R02-400
11	High efficiency nozzle	Ø 1	KNH-R02-100
12		Ø 1.5	KNH-R02-150
13		Ø 2	KNH-R02-200
21	Low noise nozzle with male thread	Ø 0.75 x 4	KNS-R02-075-4
22		Ø 0.9 x 8	KNS-R02-090-8
23		Ø 1 x 4	KNS-R02-100-4
24		Ø 1.1 x 8	KNS-R02-110-8

Extension nozzle

Symbol	Type	Nozzle length	Nozzle size	Nozzle part no.	
31	Ø 6 copper extension nozzle (Note)	300 mm	Ø 1.5	VMG1-06-150-300	
32			Ø 2	VMG1-06-200-300	
33			Ø 1.5	VMG1-06-150-600	
34		600 mm	Ø 2	VMG1-06-200-600	
35			100 mm	Ø 1.5	VMG1-06-150-100
36				Ø 2	VMG1-06-200-100
37	150 mm	Ø 1.5	VMG1-06-150-150		
38			VMG1-06-200-150		
41	Ø 8 copper extension nozzle (Note)	100 mm	Ø 2.5	VMG1-08-250-100	
42			Ø 3	VMG1-08-300-100	
43			Ø 3.5	VMG1-08-350-100	
44			150 mm	Ø 2.5	VMG1-08-250-150
45		Ø 3		VMG1-08-300-150	
46		Ø 3.5		VMG1-08-350-150	
47		300 mm		Ø 2.5	VMG1-08-250-300
48			Ø 3	VMG1-08-300-300	
49			Ø 3.5	VMG1-08-350-300	
50			600 mm	Ø 2.5	VMG1-08-250-600
51		Ø 3		VMG1-08-300-600	
52		Ø 3.5		VMG1-08-350-600	

Note) Part number for set of extension nozzle and fitting. Extension nozzle and fitting are included in the same package. Refer to "How to attach extension nozzle" in the operation manual for assembly procedures.

Specifications

Fluid	Air	
Operating pressure range	0 to 1.0 MPa	
Proof pressure	1.5 MPa	
Ambient and fluid temperature	-5 to 60 °C (No freezing)	
Flow-rate characteristics (With nozzle removed)	C (dm ³ /s·bar): 6.0, b: 0.25 (Effective area: 30 mm ²)	
Port size	Rc, NPT, G 1/4, 3/8	
Piping entry	Bottom	Top
Nozzle port size	Rc 1/4	
Weight (Main unit only)	165 g	
Operational force (when the valve is fully open)	7 N	

Nozzles for Blowing

Male thread nozzle/KN



Part no.	Connection thread D	Width across flats
KN-R02-100	Ø 1	R 1/4
KN-R02-150	Ø 1.5	
KN-R02-200	Ø 2	
KN-R02-250	Ø 2.5	
VMG1-R02-300	Ø 3	
VMG1-R02-350	Ø 3.5	
VMG1-R02-400	Ø 4	

* Reference dimensions after R thread installation

High efficiency nozzle/KNH



Part no.	Connection thread D	Width across flats
KNH-R02-100	Ø 1	R 1/4
KNH-R02-150	Ø 1.5	
KNH-R02-200	Ø 2	

* Reference dimensions after R thread installation

Low noise nozzle with male thread/KNS



Part no.	Connection thread D	Width across flats
KNS-R02-075-4	Ø 0.75 x 4	R 1/4
KNS-R02-090-8	Ø 0.9 x 8	
KNS-R02-100-4	Ø 1 x 4	
KNS-R02-110-8	Ø 1.1 x 8	

* Reference dimensions after R thread installation

Cover for male thread nozzle

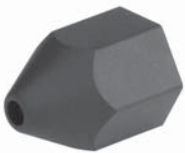

Nozzle cover part no.	Material	Applicable blow gun model	
		Model	Nozzle type
P5670129-01	HNBR	VMG1□□-□-01 to 04	Male thread nozzle Ø 1 to Ø 2.5
P5670129-01F	Fluororubber		
P5670129-02	HNBR	VMG1□□-□-05 to 07	Male thread nozzle Ø 3 to Ø 4
P5670129-02F	Fluororubber		

When cover is attached



Cover for copper extension nozzle



Nozzle cover part no.	Material	Applicable blow gun model	
		Model	Nozzle type
P5670129-11	HNBR	VMG1□□-□-31 to 38	Ø 6 copper extension nozzle
P5670129-11F	Fluororubber		

When cover is attached



Copper extension nozzle set

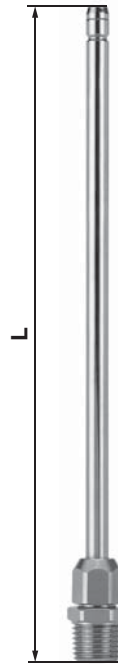

Part no.	Connection thread D	O.D.	L (Note) [mm]
VMG1-06-150-100	Ø 1.5	Ø 6	106
VMG1-06-200-100	Ø 2		
VMG1-06-150-150	Ø 1.5		156
VMG1-06-200-150	Ø 2		
VMG1-06-150-300	Ø 1.5		306
VMG1-06-200-300	Ø 2		
VMG1-06-150-600	Ø 1.5	606	
VMG1-06-200-600	Ø 2		
VMG1-08-250-100	Ø 2.5	Ø 8	106
VMG1-08-300-100	Ø 3		
VMG1-08-350-100	Ø 3.5		156
VMG1-08-250-150	Ø 2.5		
VMG1-08-300-150	Ø 3		306
VMG1-08-350-150	Ø 3.5		
VMG1-08-250-300	Ø 2.5	606	
VMG1-08-300-300	Ø 3		
VMG1-08-350-300	Ø 3.5		
VMG1-08-250-600	Ø 2.5		
VMG1-08-300-600	Ø 3		
VMG1-08-350-600	Ø 3.5		

Note) Reference dimensions after installation

Note) For dimensions and other details refer to specific catalogue of the series at www.smc.eu

Blow Gun with a Built In Hollow Fiber Membrane Element

VMG11W Series

■ Blow gun with built-in clean air filter

Please contact SMC for availability

Clean Air Filter

Application

Clean blow



Nominal filtration rating: 0.01 µm

(Filtration efficiency 99.99 %)

Element replaceable

(Utilizes an SFD101 clean air filter element)



Nozzle size

Ø 1, Ø 1.5, Ø 2, Ø 2.5

Body colour

- White
- Dark blue

Piping connection type

- Screw-in type
- S coupler plug type
- One-touch fitting type

Specifications

Maximum flow	100 l/min (ANR)
Operating pressure range	0 to 0.5 MPa
Ambient and fluid temperature	5 to 45 °C (No freezing)
Nozzle port size	Rc 1/4
Piping entry	Bottom
Operational force	7 N (Maximum value)
Weight	200 g (Blow gun body)

Note) Install a dryer (IDF, IDG, ID series), mist separator (AM series), micro mist separator (AMD series), super mist separator (AME series), or odor removal filter (AMF series), etc., for the source of the air.

Compact Pen Type Blow Gun Push Button Type

XT34-153 Series

■ Push button type compact blow gun

Blow Guns/
Silencers

VMG

KN

AN

Please contact SMC for availability

With polyurethane coil tube

With hook for hanging



Specifications

Model	XT34-153
Fluid	Air
Operating pressure range	0.1 to 1.0 MPa
Ambient and fluid temperature	$\text{Ø } 1.8$
Nozzle size	0 to 60 °C (No freezing)
Operation stroke	1.5 mm
Weight (with fitting and polyurethane coil tubing)	158 g



Pen Type/Non-Grease Blow Gun Push Button Type

XT567-10 Series

■ For blowing off of small components etc.
sensitive to oil content

Please contact SMC for availability



Specifications

Model	XT567-10
Fluid	Air
Operating pressure range	0.1 to 1.0 MPa
Nozzle size	Ø 2
Port size	Rc 1/8
Operational force	9 N (At 0.5 MPa)
Weight	100 g



Nozzles for Blowing

KN Series

Nozzle with self-align fitting/KN

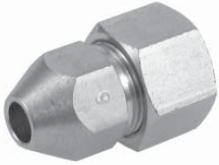

Model	Nozzle size Ø D	Applicable tubing O.D.
KN-04-100	Ø 1	Ø 4
KN-04-150	Ø 1.5	Ø 4
KN-06-100	Ø 1	Ø 6
KN-06-150	Ø 1.5	Ø 6
KN-06-200	Ø 2	Ø 6
KN-08-150	Ø 1.5	Ø 8
KN-08-200	Ø 2	Ø 8
KN-10-250	Ø 2.5	Ø 10
KN-10-300	Ø 3	Ø 10
KN-10-350	Ø 3.5	Ø 10
KN-10-400	Ø 4	Ø 10
KN-10-600	Ø 6	Ø 10
KN-12-350	Ø 3.5	Ø 12
KN-12-400	Ø 4	Ø 12
KN-12-600	Ø 6	Ø 12
KN-16-400	Ø 4	Ø 16
KN-16-600	Ø 6	Ø 16
KN-20-400	Ø 4	Ø 20
KN-20-600	Ø 6	Ø 20

Nozzle with male thread/KN



Model	Nozzle size Ø D	Connection thread
KN-R01-100	Ø 1	R 1/8
KN-R01-150	Ø 1.5	R 1/8
KN-R02-100	Ø 1	R 1/4
KN-R02-150	Ø 1.5	R 1/4
KN-R02-200	Ø 2	R 1/4
KN-R02-250	Ø 2.5	R 1/4
KN-R02-600	Ø 6	R 1/4
KN-R03-400	Ø 4	R 3/8
KN-R03-600	Ø 6	R 3/8
KN-R04-400	Ø 4	R 1/2
KN-R04-600	Ø 6	R 1/2
KN-R06-600	Ø 6	R 3/4
KN-R06-800	Ø 8	R 3/4
KN-R10-800	Ø 8	R 1

* Reference dimensions after R thread installation.

Copper extension nozzle/KNL

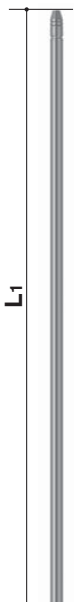

Model	Nozzle size Ø D	O.D.	L1 [mm]
KNL3-06-150	Ø 1.5	Ø 6	300
KNL3-06-200	Ø 2	Ø 6	300
KNL3-08-200	Ø 2	Ø 8	300
KNL3-08-250	Ø 2.5	Ø 8	300
KNL3-10-250	Ø 2.5	Ø 10	300
KNL3-10-300	Ø 3	Ø 10	300
KNL6-06-150	Ø 1.5	Ø 6	600
KNL6-06-200	Ø 2	Ø 6	600
KNL6-08-200	Ø 2	Ø 8	600
KNL6-08-250	Ø 2.5	Ø 8	600
KNL6-10-250	Ø 2.5	Ø 10	600
KNL6-10-300	Ø 3	Ø 10	600

Note) For dimensions and other details refer to specific catalogue of the series at www.smc.eu

Nozzle for One-touch fitting/KN



Connecting products with metal rods
Products with metal rods cannot be connected to Series KQ2 One-touch fittings. If connected, the metal rod cannot be retained by the chuck of the One-touch fitting and products with metal rods may project during pressurization, causing serious personal injury or accident. Please contact SMC for connectable One-touch fittings.

Model	Nozzle size Ø D	Applicable fitting size Ø d
KN-Q06-100	Ø 1	Ø 6
KN-Q06-150	Ø 1.5	Ø 6
KN-Q06-200	Ø 2	Ø 6
KN-Q08-150	Ø 1.5	Ø 8
KN-Q08-200	Ø 2	Ø 8
KN-Q10-200	Ø 2	Ø 10
KN-Q10-250	Ø 2.5	Ø 10
KN-Q12-250	Ø 2.5	Ø 12
KN-Q12-300	Ø 3	Ø 12

Pivoting nozzle with self-align fitting/KNK



Model	Nozzle size Ø D	Applicable tubing O.D.
KNK-10-400	Ø 4	Ø 10
KNK-10-600	Ø 6	Ø 10
KNK-12-400	Ø 4	Ø 12
KNK-12-600	Ø 6	Ø 12
KNK-16-400	Ø 4	Ø 16
KNK-16-600	Ø 6	Ø 16
KNK-20-400	Ø 4	Ø 20
KNK-20-600	Ø 6	Ø 20

Pivoting nozzle with male thread/KNK



Model	Nozzle size Ø D	Connection thread
KNK-R02-400	Ø 4	R 1/4
KNK-R02-600	Ø 6	R 1/4
KNK-R03-400	Ø 4	R 3/8
KNK-R03-600	Ø 6	R 3/8
KNK-R04-400	Ø 4	R 1/2
KNK-R04-600	Ø 6	R 1/2

* Reference dimensions after R thread installation.

High efficiency nozzle/KNH



Model	Nozzle size Ø D	Connection thread
KNH-R02-100	Ø 1	R 1/4
KNH-R02-150	Ø 1.5	R 1/4
KNH-R02-200	Ø 2	R 1/4

* Reference dimensions after R thread installation.

The air blow thrust is improved by 10 %.

Low noise nozzle with self-align fitting/KNS



Model	Nozzle size Ø D	Applicable tubing O.D.
KNS-08-075-4	Ø 0.75 x 4	Ø 8
KNS-08-100-4	Ø 1 x 4	Ø 8
KNS-10-075-4	Ø 0.75 x 4	Ø 10
KNS-10-090-8	Ø 0.9 x 8	Ø 10
KNS-10-100-4	Ø 1 x 4	Ø 10

Low noise nozzle with male thread/KNS



Model	Nozzle size Ø D	Connection thread
KNS-R01-075-4	Ø 0.75 x 4	R 1/8
KNS-R01-100-4	Ø 1 x 4	R 1/8
KNS-R01-090-8	Ø 0.9 x 8	R 1/8
KNS-R02-075-4	Ø 0.75 x 4	R 1/4
KNS-R02-090-8	Ø 0.9 x 8	R 1/4
KNS-R02-100-4	Ø 1 x 4	R 1/4
KNS-R02-110-8	Ø 1.1 x 8	R 1/4

* Reference dimensions after R thread installation.

AN Series

■ Connection thread: **M3, M5, R**

■ Applicable one-touch fitting size: **∅ 6 to ∅ 12**

Compact Resin Type/Male Thread

AN

Compact, Lightweight
Noise reduction: 30 dB(A)



Specifications

Fluid	Compressed air
Max. operating pressure ^{Note 1)}	1.0 MPa
Noise reduction	30 dB (A) ^{Note 2)}
Ambient and fluid temperature	5 to 60 °C ^{Note 3)}

Note 1) It indicates the inlet pressure for solenoid valve.

Note 2) The value may vary, depending on the pneumatic circuit or pressure that is exhausted from the solenoid valve.

Note 3) The product can be used in temperatures -10 to 60 °C if there is no risk of water droplets forming and freezing.

Performance

Model	Effective area [mm ²]	Sonic conductance C [dm ³ /(s·bar)]	Recommended flow [m ³ /min] (ANR)	Weight [g]
AN05-M5	5	1	0.4 or less	0.5
AN10-01	10	2	0.8 or less	1
AN15-02	15	3	1.0 or less	2.5
AN20-02	35	7	3.0 or less	4
AN30-03	60	12	5.0 or less	5.5
AN40-04	90	18	8.0 or less	8.5

Note) Recommended flow rate is the flow at 0.5 MPa in the inlet pressure.

Model

Model	Port size R, NPT	Dimensions [mm]	
		Full length	O.D. (∅)
AN05-M5	M5 x 0.8	15	6.5
AN10-01	1/8	23	11
AN15-02	1/4	32	16
AN20-02	1/4	45	16.5
AN30-03	3/8	58.5	20
AN40-04	1/2	68	24

Compact Resin Type/One-touch Fitting Connection

AN-C

Can connect with One-touch fitting directly.
Noise reduction: 30 dB(A)



Specifications

Fluid	Compressed air
Max. operating pressure ^{Note 1)}	1.0 MPa
Noise reduction	30 dB (A) ^{Note 2)}
Ambient and fluid temperature	5 to 60 °C ^{Note 3)}

Note 1) It indicates the inlet pressure for solenoid valve.

Note 2) The value may vary, depending on the pneumatic circuit or pressure that is exhausted from the solenoid valve.

Note 3) The product can be used in temperatures -10 to 60 °C if there is no risk of water droplets forming and freezing.

Performance

Model	Effective area [mm ²]	Sonic conductance C [dm ³ /(s·bar)]	Recommended flow [m ³ /min] (ANR)	Weight [g]
AN10-C06	7	1.4	0.8 or less	1
AN10-C07				1
AN15-C08	20	4	3.0 or less	1.4
AN20-C10	30	6	5.0 or less	3.5
AN20-C11	25	5	3.0 or less	3.5
AN30-C12	41	8.2	5.0 or less	5

Note) Recommended flow rate is the flow at 0.5 MPa in the inlet pressure.

Model

Model	Dimensions [mm]	
	Full length	O.D. (∅)
AN10-C06	36.5	11
AN10-C07		
AN15-C08	45	13
AN20-C10	57.5	16.5
AN20-C11		
AN30-C12	71.5	20

Note) For dimensions and other details refer to specific catalogue of the series at www.smc.eu

Metal Body Type

AN□00

Low back pressure,
Easy mounting.
Noise reduction: 30 dB(A)

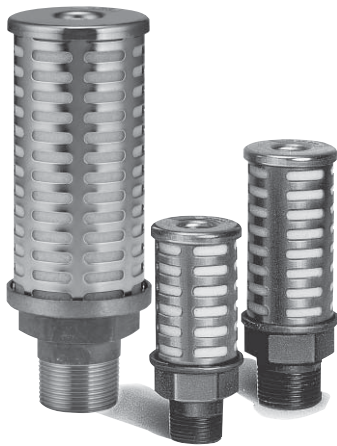

Specifications

Fluid	Compressed air
Max. operating pressure ^{Note 1)}	1.0 MPa
Noise reduction	30 dB (A) ^{Note 2)}
Ambient and fluid temperature	5 to 60 °C ^{Note 3)}

Note 1) It indicates the inlet pressure for solenoid valve.

Note 2) The value may vary, depending on the pneumatic circuit or pressure that is exhausted from the solenoid valve.

Note 3) The product can be used in temperatures -10 to 60 °C if there is no risk of water droplets forming and freezing.

Performance

Model	Effective area [mm ²]	Sonic conductance C [dm ³ /(s·bar)]	Recommended flow [m ³ /min] (ANR)	Weight [g]
AN500-06	160	32	12 or less	165
AN600-10	270	54	20 or less	220
AN700-12	440	88	30 or less	435
AN800-14	590	118	50 or less	510
AN900-20	960	192	80 or less	740

Note) Recommended flow rate is the flow at 0.5 MPa in the inlet pressure.

Model

Model	Port size R, NPT	Dimensions [mm]	
		Full length	O.D. (Ø)
AN500-06	3/4	107	46
AN600-10	1	127	50
AN700-12	1 1/4	186	74
AN800-14	1 1/2	217	74
AN900-20	2	256	86

Metal Case Type

25□□

Prevents scattering of
mist and noise.
Noise reduction: 19 dB(A)



Specifications

Fluid	Compressed air
Max. operating pressure ^{Note 1)}	1.0 MPa
Noise reduction	19 dB (A) ^{Note 2)}
Ambient and fluid temperature	5 to 60 °C ^{Note 3)}

Note 1) It indicates the inlet pressure for solenoid valve.

Note 2) The value may vary, depending on the pneumatic circuit or pressure that is exhausted from the solenoid valve.

Note 3) The product can be used in temperatures -10 to 60 °C if there is no risk of water droplets forming and freezing.

Model

Model	Port size R	Effective area [mm ²]	Sonic conductance C [dm ³ /(s·bar)]	Recommended flow [m ³ /min] (ANR)	Weight [g]	Dimensions [mm]	
						Full length	O.D. (Ø)
2504-002	1/4	33.9	6.8	2.2 or less	111	62	30
2505-003	3/8	45.9	9.2	3.0 or less	106	64	30
2506-004	1/2	50.0	10.0	4.0 or less	113	68	30
2507-006	3/4	105.6	21.1	8.0 or less	310	88.5	48
2508-010	1	129.6	25.9	10.0 or less	514	97.5	60
2510-002	1/4	17.2	3.4	1.5 or less	57	54	22
2511-003	3/8	17.2	3.4	1.5 or less	55	56	22

Note) For dimensions and other details refer to specific catalogue of the series at www.smc.eu

Note) Recommended flow rate is the flow at 0.5 MPa in the inlet pressure.

BC Sintered Body Type

AN1□□-□

Noise reduction:
13, 16, 18, 21 dB(A)
Ambient and fluid temperature:
5 to 150 °C



AN110

AN101

AN120

Specifications

Specifications	Model			
	AN101-01	AN110-01	AN120-M3	AN120-M5
Port size ^{Note 1)}	R 1/8	R 1/8	M3	M5
Noise reduction dB (A) ^{Note 3)}	16	21	13	18
Fluid	Compressed air			
Max. operating pressure ^{Note 2)}	1.0 MPa			
Ambient and fluid temperature	5 to 150 °C ^{Note 4)}			
Effective area [mm ²]	20	35	1	5
Sonic conductance C [dm ³ /(s·bar)]	4	7	0.2	1
Weight [g]	8.3	17	1	3.4

Note 1) NPT thread for AN101 and AN110 is also available. Model no. of NPT thread is AN101-N01 and AN110-N01.

Note 2) It indicates the inlet pressure for solenoid valve.

Note 3) The value may vary, depending on the pneumatic circuit or pressure that is exhausted from the solenoid valve.

Note 4) The product can be used in temperatures -10 to 150 °C if there is no risk of water droplets forming and freezing.

Model

Model	Port size ^{Note)}	Dimensions [mm]	
		Full length	O.D. (Ø)
AN101-01	R 1/8	21	11
AN110-01	R 1/8	34	13
AN120-M3	M3	9	6
AN120-M5	M5	15.5	8

High Noise Reduction Type

AN□02

Case adopts flame resistant material
Noise reduction: 35 dB(A)



AN202

AN302

AN402

Specifications

Fluid	Compressed air
Max. operating pressure ^{Note 1)}	1.0 MPa
Noise reduction	35 dB (A) ^{Note 2)}
Ambient and fluid temperature	5 to 60 °C ^{Note 3)}

Note 1) It indicates the inlet pressure for solenoid valve.

Note 2) The value may vary, depending on the pneumatic circuit or pressure that is exhausted from the solenoid valve.

Note 3) The product can be used in temperatures -10 to 60 °C if there is no risk of water droplets forming and freezing.

Model

Model	Port size R	Effective area [mm ²]	Sonic conductance C [dm ³ /(s·bar)]	Recommended flow [m ³ /min] (ANR)	Weight [g]	Dimensions [mm]	
						Full length	O.D. (Ø)
AN202-02	1/4	35	7	3 or less	16	64	22
AN302-03	3/8	60	12	5 or less	33	84	28
AN402-04	1/2	90	18	8 or less	47	95	34

Note) Recommended flow rate is the flow at 0.5 MPa in the inlet pressure.

Note) For dimensions and other details refer to specific catalogue of the series at www.smc.eu

40 dB (A): High Noise Reduction Type

ANA1

Keeps the in-plant noise level below 85 dB(A).
Noise reduction: 40 dB(A)



Specifications

Fluid	Compressed air
Max. operating pressure ^{Note 1)}	1.0 MPa
Noise reduction	40 dB (A) ^{Note 2)}
Ambient and fluid temperature	5 to 60 °C

Note 1) It indicates the inlet pressure for solenoid valve.

Note 2) The value may vary, depending on the pneumatic circuit or pressure that is exhausted from the solenoid valve.

Model (Screw-in connection)

Model	Port size	Effective area [mm ²]	Sonic conductance C [dm ³ /(s·bar)]	Recommended flow [m ³ /min] (ANR)	Weight [g]	Dimensions [mm]	
						Full length	O.D. (Ø)
ANA1-01	R 1/8	10	2	0.8 or less	4	37	16
ANA1-02	R 1/4	15	3	1.2 or less	14	64	22
ANA1-03	R 3/8	35	7	2.7 or less	22	84	25
ANA1-04	R 1/2	60	12	4.5 or less	36	98	30
ANA1-06	R 3/4	90	18	7.0 or less	110	111	46
ANA1-10	R 1	160	32	12.0 or less	180	132	50
ANA1-12	R 1 1/4	280	56	20.0 or less	544	200	74
ANA1-14	R 1 1/2	450	90	32.0 or less	612	230	74
ANA1-20	R 2	610	122	45.0 or less	873	271	86

Note) Recommended flow rate is the flow at 0.5 MPa in the inlet pressure.

Model (One-touch fitting connection)

Model	Applicable One-touch fitting size	Effective area [mm ²]	Recommended flow [m ³ /min] (ANR)	Weight [g]	Dimensions [mm]	
					Full length	O.D. (Ø)
ANA1-C08	Ø 8	11	0.8 or less	5	58	16
ANA1-C10	Ø 10	15	1.2 or less	13	76	22
ANA1-C12	Ø 12	33	2.5 or less	19	95	25

38 dB (A): High Noise Reduction Type

ANB1

Has a larger effective area than the ANA1 series, but with the same port size.
Noise reduction: 38 dB(A)



Specifications

Fluid	Compressed air
Max. operating pressure ^{Note 1)}	1 MPa
Noise reduction	38 dB (A) ^{Note 2)}
Ambient and fluid temperature	5 to 60 °C

Note 1) It indicates the inlet pressure for solenoid valve.

Note 2) The value may vary, depending on the pneumatic circuit or pressure that is exhausted from the solenoid valve.

Model (Screw-in connection)

Model	Port size	Effective area [mm ²]	Sonic conductance C [dm ³ /(s·bar)]	Recommended flow [m ³ /min] (ANR)	Weight [g]	Dimensions [mm]	
						Full length	O.D. (Ø)
ANB1-01	R 1/8	15	3	1.2 or less	10	51	22
ANB1-02	R 1/4	35	7	2.7 or less	22	81	25
ANB1-03	R 3/8	60	12	3.8 or less	35	93	30
ANB1-04	R 1/2	90	18	7.0 or less	94	107	46
ANB1-06	R 3/4	160	32	12.0 or less	175	133	50
ANB1-10	R 1	280	56	20.0 or less	462	190	74
ANB1-12	R 1 1/4	450	90	32.0 or less	612	230	74
ANB1-14	R 1 1/2	610	122	45.0 or less	871	271	86

Note) Recommended flow rate is the flow at 0.5 MPa in the inlet pressure.

Model (One-touch fitting connection)

Model	Applicable One-touch fitting size	Effective area [mm ²]	Recommended flow [m ³ /min] (ANR)	Weight [g]	Dimensions [mm]	
					Full length	O.D. (Ø)
ANB1-C06	Ø 6	8	0.6 or less	5	52	16
ANB1-C08	Ø 8	13	1.0 or less	12	73	22
ANB1-C10	Ø 10	28	2.0 or less	28	94	25

Note) Recommended flow rate is the flow at 0.5 MPa in the inlet pressure.

Note) For dimensions and other details refer to specific catalogue of the series at www.smc.eu

Silencer (BC Sintered Body)

RoHS

AN120-M3-X313 Series

■ Connection to a product with a narrow piping pitch is possible.

Please contact SMC for availability



Measures for space saving

- Port size: M3
- Dimensions [mm]: \varnothing 4.5 x height 8

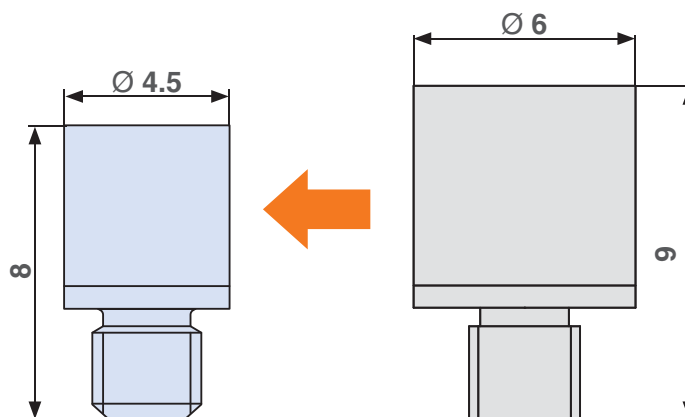

AN120-M3-X313

AN120-M3
(Standard product)

Specifications

Fluid	Air
Noise reduction	15 dB(A)
Effective area	0.6 mm ²
Ambient and fluid temperature	5 to 150 °C*
Surface treatment	Electroless nickel plated

* The product can be used in a temperature range of -10 to 150 °C when no water droplets occur from the fluid.

Plug Type Silencer

EBKX Series

■ Compact plug type silencer with an integrated BC element!

Please contact SMC for availability



Port size: R 1/8, R 1/4, R 3/8, R 1/2

The silencer can be installed in the exhaust ports of solenoid valves, without interfering with components, such as fittings.

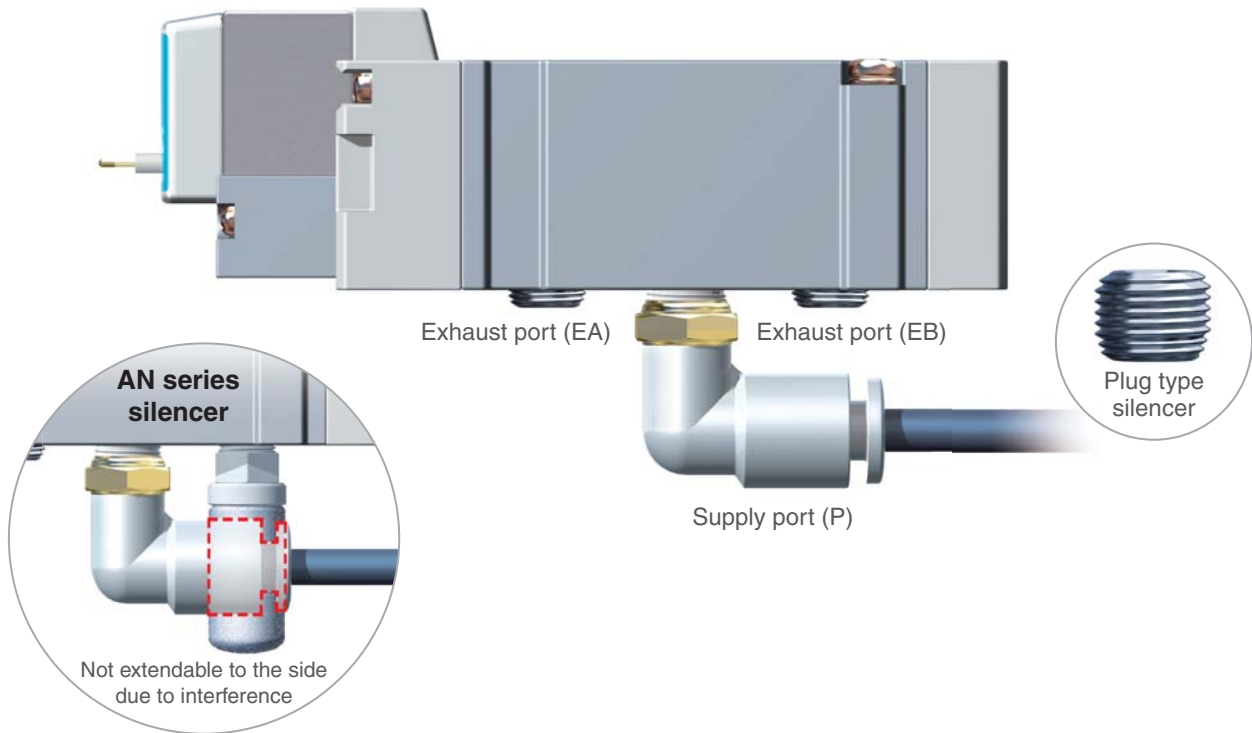

Prevents intrusion of foreign matter into vent hole and air vent (air release)

Specification



Model	Port size	Effective area [mm ²]	Sonic conductance C	Noise reduction ¹⁾ [dB]	Max. operating pressure ²⁾
EBKX-W4005	R 1/8	1.8	0.36	25	1 MPa
EBKX-Z2003	R 1/4	4.1	0.8	25	
EBKX-W4006	R 3/8	5.5	1.1	30	
EBKX-C2002	R 1/2	8.2	1.6	30	

1) Inlet pressure of solenoid valve

2) May change depending on the pneumatic circuit or the pressure to be exhausted from the solenoid valve.

Safety Instructions

These safety instructions are intended to prevent hazardous situations and/or equipment damage. These instructions indicate the level of potential hazard with the labels of “**Caution**,” “**Warning**” or “**Danger**.” They are all important notes for safety and must be followed in addition to International Standards (ISO/IEC)*1), and other safety regulations.

-  **Caution:** **Caution** indicates a hazard with a low level of risk which, if not avoided, could result in minor or moderate injury.
-  **Warning:** **Warning** indicates a hazard with a medium level of risk which, if not avoided, could result in death or serious injury.
-  **Danger:** **Danger** indicates a hazard with a high level of risk which, if not avoided, will result in death or serious injury.

- *1) ISO 4414: Pneumatic fluid power – General rules relating to systems.
- ISO 4413: Hydraulic fluid power – General rules relating to systems.
- IEC 60204-1: Safety of machinery – Electrical equipment of machines. (Part 1: General requirements)
- ISO 10218-1: Manipulating industrial robots - Safety. etc.

Warning

1. The compatibility of the product is the responsibility of the person who designs the equipment or decides its specifications.

Since the product specified here is used under various operating conditions, its compatibility with specific equipment must be decided by the person who designs the equipment or decides its specifications based on necessary analysis and test results. The expected performance and safety assurance of the equipment will be the responsibility of the person who has determined its compatibility with the product. This person should also continuously review all specifications of the product referring to its latest catalogue information, with a view to giving due consideration to any possibility of equipment failure when configuring the equipment.

2. Only personnel with appropriate training should operate machinery and equipment.

The product specified here may become unsafe if handled incorrectly. The assembly, operation and maintenance of machines or equipment including our products must be performed by an operator who is appropriately trained and experienced.

3. Do not service or attempt to remove product and machinery/equipment until safety is confirmed.

1. The inspection and maintenance of machinery/equipment should only be performed after measures to prevent falling or runaway of the driven objects have been confirmed.
2. When the product is to be removed, confirm that the safety measures as mentioned above are implemented and the power from any appropriate source is cut, and read and understand the specific product precautions of all relevant products carefully.
3. Before machinery/equipment is restarted, take measures to prevent unexpected operation and malfunction.

4. Contact SMC beforehand and take special consideration of safety measures if the product is to be used in any of the following conditions.

1. Conditions and environments outside of the given specifications, or use outdoors or in a place exposed to direct sunlight.
2. Installation on equipment in conjunction with atomic energy, railways, air navigation, space, shipping, vehicles, military, medical treatment, combustion and recreation, or equipment in contact with food and beverages, emergency stop circuits, clutch and brake circuits in press applications, safety equipment or other applications unsuitable for the standard specifications described in the product catalogue.
3. An application which could have negative effects on people, property, or animals requiring special safety analysis.
4. Use in an interlock circuit, which requires the provision of double interlock for possible failure by using a mechanical protective function, and periodical checks to confirm proper operation.

Limited warranty and Disclaimer/ Compliance Requirements

The product used is subject to the following “Limited warranty and Disclaimer” and “Compliance Requirements”.

Read and accept them before using the product.

Limited warranty and Disclaimer

1. The warranty period of the product is 1 year in service or 1.5 years after the product is delivered, whichever is first.*2)
Also, the product may have specified durability, running distance or replacement parts. Please consult your nearest sales branch.
2. For any failure or damage reported within the warranty period which is clearly our responsibility, a replacement product or necessary parts will be provided. This limited warranty applies only to our product independently, and not to any other damage incurred due to the failure of the product.
3. Prior to using SMC products, please read and understand the warranty terms and disclaimers noted in the specified catalogue for the particular products.

*2) Vacuum pads are excluded from this 1 year warranty.

A vacuum pad is a consumable part, so it is warranted for a year after it is delivered. Also, even within the warranty period, the wear of a product due to the use of the vacuum pad or failure due to the deterioration of rubber material are not covered by the limited warranty.

Compliance Requirements

1. The use of SMC products with production equipment for the manufacture of weapons of mass destruction (WMD) or any other weapon is strictly prohibited.
2. The exports of SMC products or technology from one country to another are governed by the relevant security laws and regulations of the countries involved in the transaction. Prior to the shipment of a SMC product to another country, assure that all local rules governing that export are known and followed.

Caution

1. The product is provided for use in manufacturing industries.

The product herein described is basically provided for peaceful use in manufacturing industries.

If considering using the product in other industries, consult SMC beforehand and exchange specifications or a contract if necessary.

If anything is unclear, contact your nearest sales branch.

Caution

SMC products are not intended for use as instruments for legal metrology.

Measurement instruments that SMC manufactures or sells have not been qualified by type approval tests relevant to the metrology (measurement) laws of each country. Therefore, SMC products cannot be used for business or certification ordained by the metrology (measurement) laws of each country.

Safety Instructions

Be sure to read “Handling Precautions for SMC Products” (M-E03-3) before using.

For Pneumatic Piping/Fittings & Tubing Prior to Use

Fittings with Sealant

Seal material (fluororesin) is coated on the thread part with the proper thickness and range, that reduces the piping work, such as coating the seal on the thread.

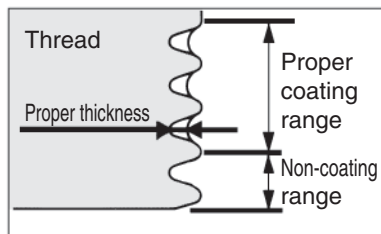
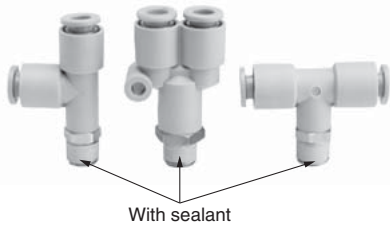

Female Thread Conditions Applicable to Face Seal

1. Surface roughness of bearing surface: Rz 25 or less
2. Chamfer dimension: $\varnothing D1$, Seal bearing surface diameter: $\varnothing D2$ (Refer to the table below.)
3. Female thread inclination angle: 1° or less
4. Counterbore diameter when the female thread is counterbored.: $\varnothing D3$
 - Models with width across flats: Body width across flats x 1.1 or more
 - Models other than hexagon (Hexagon socket head male connector etc.): Body dimensions + 0.2 mm or more
- * The width across flats and the body dimensions differ depending on the model even when the same thread size is used. Refer to the dimensions in the catalogue.
5. If oil content or sealant is sticking to the female thread, this may cause damage of the product. Remove it before piping.

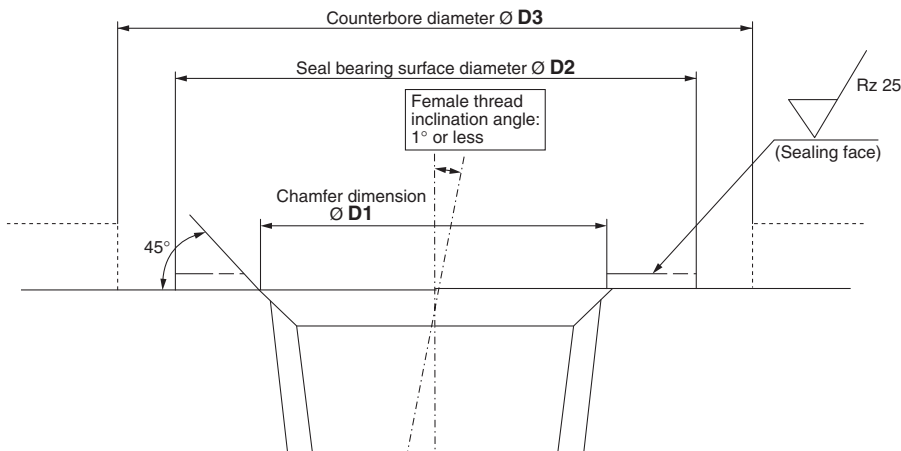

Table 1

Connection thread size	Chamfer dimension $\varnothing D1$ mm	Seal bearing surface diameter $\varnothing D2$ mm
R 1/8	10.2 to 10.4	12 or more
R 1/4	13.6 to 13.8	17 or more
R 3/8	17.1 to 17.3	21 or more
R 1/2	21.4 to 21.6	27 or more
NPT 1/16	8.2 to 8.4	11.11 or more
NPT 1/8	10.5 to 10.7	12.7 or more
NPT 1/4	14.1 to 14.3	17.46 or more
NPT 3/8	17.4 to 17.6	22 or more
NPT 1/2	21.7 to 21.9	28.7 or more
G 1/8	10.2 to 10.6	12 or more
G 1/4	13.6 to 14.0	17 or more
G 3/8	17.1 to 17.5	21 or more
G 1/2	21.4 to 21.8	27 or more

⚠ Precautions

For products that do not satisfy the female thread conditions shown above and the piping with a piping pitch narrower than the product dimension, use the conventional sealant type.

* The rubber parts of the face seal cannot be replaced.

* The rubber parts of the face seal may fall off by the air blow and they cannot be mounted again. Be careful not to perform the air blow.



Fittings & Tubing Precautions 1

Be sure to read this before handling.

Design/Selection

Warning

1. Check the specifications.

The products in this catalogue are designed to be used in compressed air systems (including vacuum) only. If the products are used in an environment where pressure or temperature is out of the specified range, damage and/or malfunction may result. Do not use under such conditions. (Refer to the specifications.) Please consult with SMC when using a fluid other than compressed air (including vacuum). We do not guarantee against any damage if the product is used outside of the specification range.

2. Do not disassemble the product or make any modifications, including additional machining.

It may cause human injury and/or an accident.

3. Check if PTFE can be used in application.

PTFE powder (Polytetrafluoroethylene resin) is included in the seal material. Confirm that the use of it will not cause any adverse affect on the system.

Caution

1. Keep the connection part of fittings and tubing from rotating or oscillating movement. Use Rotary One-touch Fittings Series KS or KX in these cases.

The fittings may be damaged if they are used in the above manner.

2. The tubing bending radius in the vicinity of the fitting should be at least the minimum bending radius of the tubing.

If the bending radius is less than the min. value, fittings may damage, or tubing may crack or be crushed. The minimum bending radius of the FR soft nylon tubing (Series TRS), FR double layer tubing (Series TRB), antistatic soft nylon tubing (Series TAS), polyolefin tubing (Series TPH), soft polyolefin tubing (Series TPS) is measured as following in accordance with JIS B8381.

Tubing deformation ratio at the minimum bending radius is obtained through the following formula, based on tubing diameter and mandrel diameter by wrapping the same radius mandrel tube.

$$\eta = \left(1 - \frac{L - D}{2d}\right) \times 100$$

Here, η : Deformation ratio (%)
 d : Tubing diameter [mm]
 L : Measured length [mm]
 D : Mandrel diameter [mm]
(Twice against the minimum bending radius)

Test temperature: 20 ±5 °C
Relative humidity: 65 ±5 %

Tube deformation ratio at the minimum bending radius

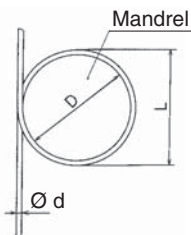

3. Do not use fluids other than listed on the specifications.

Applicable fluids are air and water. Please consult with SMC if using other fluids.

4. When it is used with water, the fittings or tubing may be damaged depending on the surge pressure.

Mounting/Piping

Warning

1. Operation manual

Install the products and operate them only after reading the operation manual carefully and understanding its contents. Also, keep the manual where it can be referred to as necessary.

2. Ensure sufficient space for maintenance activities.

When installing the products, allow access for maintenance.

3. Tightening the threaded portion of the thread.

When installing the products, refer to "Tightening the threaded portion of the connection thread".

4. There may be cases of the tubing detaching from the fitting and thrashing around uncontrollably due to tubing degradation or fitting breakage.

To prevent the situation from becoming uncontrollable, fit the tubing with a protective cover or fix it in place.

Caution

1. Preparation before piping

Before piping is connected, it should be thoroughly blown out with air (flushing) or washed to remove chips, cutting oil and other debris from inside the pipe.

2. Wrapping of pipe tape

When screwing together pipes and fittings, etc., be certain that chips from the pipe threads and sealing material do not get inside the pipe. Also, when the pipe tape is used, leave approx. 1 thread ridges exposed at the end of the threads.

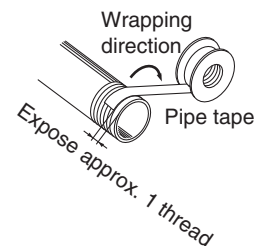

3. Check the model, type and size before installation. Also, confirm that there is no scratches, gouges or cracks on the product.

4. When connecting the tubing, take pressure or possible changes to the tubing length into account, and allow a sufficient margin.

Failure to do so may result in fitting breakage or detachment of the tubing. Refer to the recommended piping conditions.

5. Do not apply unnecessary forces such as twisting, pulling, moment loads, vibration and impact, etc. on fittings or tubing.

This will cause damage to fittings and will crush, burst or release tubing.

6. Tubing, with the exception of coiled tubing, requires stationary installation. Do not use standard tubing (non-coiled) in applications where tubing is required to travel inside the flexible protection tube. Tubing that travels may sustain abrasion, extension, or severance due to tensile force, or may result in removal of tubing from fitting. Use caution prior to use for proper application.

7. To install the fitting, screw the fitting into the hexagonal face of the body, and tighten with an appropriate wrench.

Affix the wrench at the base of the thread. If the size of hexagonal face and wrench do not match, or tightening takes place near the tube side, it may cause collapse or deformation of the hexagonal face, or damage to the equipment. After installing, confirm that there is no damage to the fitting, etc.



Fittings & Tubing Precautions 2

Be sure to read this before handling.

Air Supply

Warning

1. Type of fluids

Please consult with SMC when using the product in applications other than compressed air.

Regarding products for general fluids, please contact SMC concerning applicable fluids.

2. When there is a large amount of drainage.

Compressed air containing a large amount of drainage can cause malfunction of pneumatic equipment. An air dryer or water separator should be installed upstream from filters.

3. Drain flushing

If condensation in the drain bowl is not emptied on a regular basis, the bowl will overflow and allow the condensation to enter the compressed air lines. It causes malfunction of pneumatic equipment.

If the drain bowl is difficult to check and remove, installation of a drain bowl with an auto drain option is recommended.

For details on the above compressed air quality, refer to www.smc.eu.

4. Use clean air.

Do not use compressed air that contains chemicals, synthetic oils including organic solvents, salt or corrosive gases, etc., as it can cause damage or malfunction.

Caution

1. Install an air filter.

Install an air filter at the upstream side of valve.

Select an air filter with a filtration degree of 5 µm or finer.

2. Install an after-cooler, air dryer or water droplet separator, etc.

Compressed air that contains a large amount of drainage can cause malfunction of pneumatic equipment. Therefore, take appropriate measures to ensure air quality, such as by providing an aftercooler, air dryer, or water droplet separator.

3. Ensure that the fluid and ambient temperature are within the specified range.

If the fluid temperature is 5 °C or less, the moisture in the circuit could freeze, causing damage to the seals and leading to equipment malfunction. Therefore, take appropriate measures to prevent freezing.

For details on the above compressed air quality, refer to www.smc.eu.

Operating Environment

Warning

1. Do not use in an atmosphere having corrosive gases, chemicals, sea water, water, water steam, or where there is direct contact with any of these.

Refer to each construction drawing on the fittings and tubing material.

2. Do not expose the product to direct sunlight for an extended period of time.

3. Do not use in a place subject to heavy vibration and/or shock.

4. Do not mount the product in locations where it is exposed to radiant heat.

Operating Environment

Warning

5. Do not use the ordinary fittings and tubing in locations where static electricity would be problematic.

It may result in the system failure and trouble. In such places, use of antistatic fittings (Series KA) and antistatic tubing (Series TA) are recommended.

6. Do not use the ordinary fittings and tubing in locations where spatter is generated.

Spattering may result in a fire hazard. In such a place, use of flame resistant fittings (Series KR/KRM) and flame resistant tubing (Series TRS/TRB/TRBU/TRTU) are recommended.

7. Do not use in an environment where the product is directly exposed to cutting oil, lubricant, coolant oil, etc.

Please contact SMC if using for an environment exposed to cutting oil, lubricant or coolant oil, etc.

8. Take note that if nylon tubing, soft nylon tubing and antistatic tubing are used in a clean room.

The antioxidant on the surface of the soft nylon tubing may come off, thereby lowering the cleanliness level.

9. Do not use in environments where foreign matter may stick to the product or get mixed in the product's interior.

This may cause leakage or disconnection of the tubing.

Maintenance

Warning

1. Perform maintenance inspection according to the procedures indicated in the operation manual.

If handled improperly, malfunction and damage of machinery or equipment may occur.

2. Maintenance work

If handled improperly, compressed air can be dangerous. Assembly, handling, repair and element replacement of pneumatic systems should be performed by a knowledgeable and experienced person.

3. Drain flushing

Remove drainage from air filters regularly.

4. Removal of equipment, and supply/exhaust of compressed air

When components are removed, first confirm that measures are in place to prevent workpieces from dropping, run-away equipment, etc. Then, cut off the supply pressure and electric power, and exhaust all compressed air from the system using the residual pressure release function.

When machinery is restarted, proceed with caution after confirming that appropriate measures are in place to prevent cylinders from sudden movement.



Fittings & Tubing Precautions 3

Be sure to read this before handling.

Maintenance

⚠ Caution

1. Be certain to wear safety glasses at all times during periodical inspections.
2. Replace fittings or tubing having the following problems.
 - 1) Cracks, gouges, wearing, corrosion
 - 2) Air leakage
 - 3) Twists or crushing of tubing
 - 4) Hardening, deterioration, softening of tubing
3. When replacing tubes or fittings, do not try to mend or repair and then reuse them.

One-touch Fittings Mounting/Piping

⚠ Caution

1. Installation and removal of tubing for One-touch fittings

1) Installation of tubing

- (1) Cut the tubing perpendicularly, being careful not to damage the outside surface. Use an SMC tube cutter "TK-1", "TK-2" or "TK-3". Do not cut the tubing with pliers, nippers, scissors, etc., otherwise, the tubing will be deformed and trouble may result.
- (2) The outside diameter of the polyurethane tubing swells when internal pressure is applied to it. Therefore, it may be possible that the tubing cannot be re-inserted into the One-touch fitting. Check the tubing outside diameter, and when the accuracy of the outside diameter is +0.07 mm or larger for $\varnothing 2$, +0.15 mm or larger for other sizes, insert into the One-touch fitting again, without cutting the tubing to use it. When the tubing is re-inserted into the One-touch fitting, confirm that the tubing goes through the release button smoothly.
- (3) Grasp the tubing, slowly push it straight (0 to 5°) into the One-touch fitting until it comes to a stop.
- (4) Pull the tubing back gently to make sure it has a positive seal. Insufficient installation may cause air to leak or the tubing to release.

2) Removal of tubing

- (1) Push the release button flange evenly and sufficiently to release the tube.
- (2) Pull out the tubing while keeping the release button depressed. If the release button is not held down sufficiently, the tubing cannot be withdrawn.
- (3) To reuse the tubing, remove the previously lodged portion of the tubing. If the lodged portion is left on without being removed, it may result in air leakage and removal of the tubing difficult.

2. Connecting products with metal rods

Products with metal rods (Series KC, old Series KQ, Series KN, and Series KM, etc.) cannot be connected to Series KQ2 One-touch fittings. If connected, the metal rod cannot be retained by the chuck of the One-touch fitting and products with metal rods may project during pressurization, causing serious personal injury or accident.

Even when products with metal rods can be connected to other One-touch fittings, do not use any tube, resin plug, or reducer after connection. This may cause releasing.

For details about One-touch fittings that can connect products with metal rods, contact SMC.

One-touch Fittings Mounting/Piping

⚠ Caution

3. When mounting tubes, resin plugs, reducers etc., do not press the release button.

Also, do not press the release button unnecessarily before mounting them. This may cause those parts to come off.

In particular, when piping products, such as plug-in elbows or reducers, etc. the release button may be pressed easily due to product handling during piping work.

Tightening the threaded portion of the connection thread

1. Connection thread: M3

First, tighten by hand, then use a wrench appropriate for the hexagon flats of the body to tighten an additional 1/4 turn. A reference value for the tightening torque is 0.4 to 0.5 N·m.

2. Connection thread: M5 and 10-32UNF

First, tighten by hand, then use a wrench appropriate for the hexagon flats of the body to tighten an additional 1/6 to 1/4 turn. A reference value for the tightening torque is 1 to 1.5 N·m.

3. M6

First, tighten by hand, then use a wrench appropriate for the hexagon flats of the body to tighten an additional 1/6 to 1/4 turn. Note) Excessive tightening may damage the thread portion or deform the gasket and cause air leakage. Insufficient tightening may loosen the threads, or cause air leakage.

4. Fittings with sealant: R, NPT

1. First, tighten the fitting by hand, then use a wrench appropriate for the hexagon flats of the body to tighten it a further two or three turns. For a tightening torque guide, see the table below.

Connection thread size (R, NPT)	Tightening torque [N·m]
1/16, 1/8	3 to 5
1/4	8 to 12
3/8	15 to 20
1/2	20 to 25

2. If the fitting is tightened with excessive torque, a large amount of sealant will seep out. Remove the excess sealant.

3. Insufficient tightening may cause seal failure, or loosen the threads.

4. Reuse

- 1) Normally, fittings with a sealant can be reused 2 to 3 times.
- 2) To prevent air leakage through the sealant, remove any loose sealant stuck to the fitting by blowing air over the threaded portion.
- 3) If the sealant no longer provides effective sealing, wrap sealing tape over the sealant before reusing. Do not use the sealant in any form other than a tape type.
- 4) Once the fitting has been tightened, backing it out to its original position often causes the sealant to become defective. Air leakage will occur.



Fittings & Tubing Precautions 4

Be sure to read this before handling.

Tightening the threaded portion of the connection thread

5. Uni Thread Fittings

- 1) First, tighten the threaded portion by hand, then use a proper wrench, which could be suitable for the width across flats of the hexagon body, to tighten it further at a wrench tightening angle shown below. As a reference value for the tightening torque, refer to the table below.

Connection Female Thread: Rc, NPT, NPTF

Uni thread size	Wrench tightening angle after tightened by hand [deg]	Tightening torque [N·m]
1/8	30 to 60	3 to 5
1/4	30 to 60	8 to 12
3/8	15 to 45	14 to 16
1/2	15 to 30	20 to 22

Connection Female Thread: G

Uni thread size	Wrench tightening angle after tightened by hand [deg]	Tightening torque [N·m]
1/8	30 to 45	3 to 4
1/4	15 to 30	4 to 5
3/8	15 to 30	8 to 9
1/2	15 to 30	14 to 15

- 2) The gasket can be recycled up to 6 to 10 times. It can be replaced easily when it has sustained damage. A broken gasket can be removed by holding it and then turning it in the same direction as loosening the thread. If gasket is difficult to remove, cut it with nippers, etc. In such a case, use caution not to scratch the seat face because the seat face of 45° gasket of fitting is the sealing face.

Chamfer Dimension for Female Thread

⚠ Caution

1. Chamfer dimension for female thread of the connection thread M3, M5, 10-32UNF

Confirming to ISO 16030 (air pressure fluid dynamics – connection – ports and stud ends), the chamfer dimensions shown below are recommended. By chamfering as shown in the following table, machining of threads is easier and effective for burr prevention.

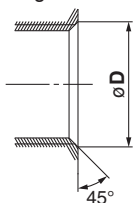

Connection thread size	Chamfer dimension Ø D (Recommended value) [mm]
M3	3.1 to 3.4
M5	5.1 to 5.4
10-32UNF	5.0 to 5.3

2. Chamfer dimension of R and NPT thread with sealant, and Uni thread

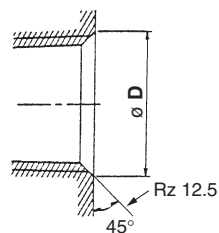

Connection thread size	Chamfer dimension Ø D (Recommended value)		
	G	Rc	NPT, NPTF
1/16	—	—	8.2 to 8.4
1/8	10.2 to 10.6	10.2 to 10.4	10.5 to 10.7
1/4	13.6 to 14.0	13.6 to 13.8	14.1 to 14.3
3/8	17.1 to 17.5	17.1 to 17.3	17.4 to 17.6
1/2	21.4 to 21.8	21.4 to 21.6	21.7 to 21.9

* For Uni thread, Rz 12.5 is necessary for sealing at the chamfered part.

Recommended Piping Conditions

1. When connecting piping to the One-touch fitting, use pipe length with sufficient margin, in accordance with the piping conditions shown in Fig. 1.

Also, when using a tying band, etc., to bind the piping together, make sure that external force does not come to bear on the fitting. (See Fig. 2.)

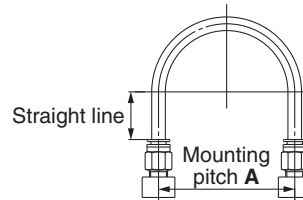

Fig. 1 Recommended piping

Unit: mm

Tubing size	Mounting pitch A			Straight line length
	Nylon tubing	Soft nylon tubing	Polyurethane tubing	
Ø 2	—	—	13 or more	10 or more
Ø 3.2, 1/8"	44 or more	35 or more	25 or more	16 or more
Ø 4, 5/32"	56 or more	44 or more	26 or more	20 or more
Ø 3/16"	67 or more	52 or more	38 or more	24 or more
Ø 6	84 or more	66 or more	39 or more	30 or more
Ø 1/4"	89 or more	70 or more	57 or more	32 or more
Ø 8, 5/16"	112 or more	88 or more	52 or more	40 or more
Ø 10	140 or more	110 or more	69 or more	50 or more
Ø 3/8"	134 or more	105 or more	69 or more	48 or more
Ø 12	168 or more	132 or more	88 or more	60 or more
Ø 1/2"	178 or more	140 or more	93 or more	64 or more
Ø 16	224 or more	176 or more	114 or more	80 or more

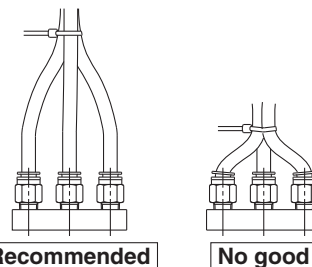

Fig. 2 When using a tying band to bind the piping together

Tubing Design/Selection

⚠ Caution

1. When using a tubing other than from SMC, be careful of the tolerance of the tubing O.D. and tubing material.

- 1) Nylon tubing Within ±0.1 mm
- 2) Soft nylon tubing Within ±0.1 mm
- 3) Polyurethane tubing Within +0.15 mm, Within -0.2 mm

Do not use the tubing which does not satisfy the specified tubing O.D. accuracy, or if the tubing has a different I.D., material, hardness, or surface roughness from those of SMC's tubing. Please consult SMC if there is anything unclear. It may cause difficulty in connecting the tubing, leakage, disconnection of the tubing, or fitting damage.

When used with tubing other than those from SMC, due to their properties, the products listed below are not subject to warranty.

KQG2, KQB2, KFG2, KF, M (Ø 2)

2. When using fittings other than those from SMC, be certain to confirm that operating conditions are such that no problems will arise.



Series KQ2C

Notes when Ordering Colour Caps

In order to improve the operability, the outside diameter of the release button has been enlarged for the **New KQ2** series. Along with this change, the usable colour caps differ before and after the change. Please contact SMC if anything is unclear.

Applicable Sizes and Models

	Applicable tubing O.D.	Model
Metric size	Ø 8, Ø 10, Ø 12, Ø 16	All models*
Inch size	Ø 1/4", Ø 3/8", Ø 1/2"	

* Excluding models without release buttons

How to Identify Release Buttons Before and After Change

The release button for both the fitting/**KQ2** and colour cap/**KQ2C** after the change can be identified by the protruding mark on the left side of the **SMC** logo, and the release button before the change has no protruding mark. The same identification method is used for metric size and inch size.

* Along with the change of the release button, the model of the colour cap/**KQ2C** is changed from **KQ2C-□A** to **KQ2C-□B**.
 * There is no change of the model for the fitting/**KQ2**.

Before change

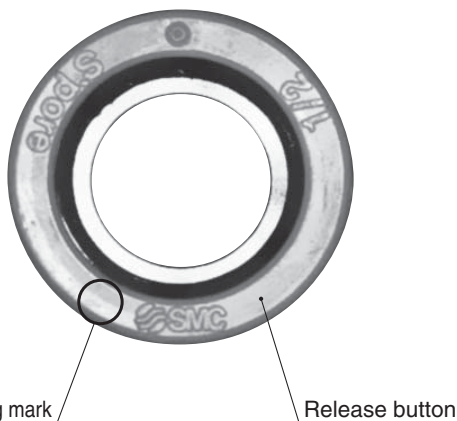

After change

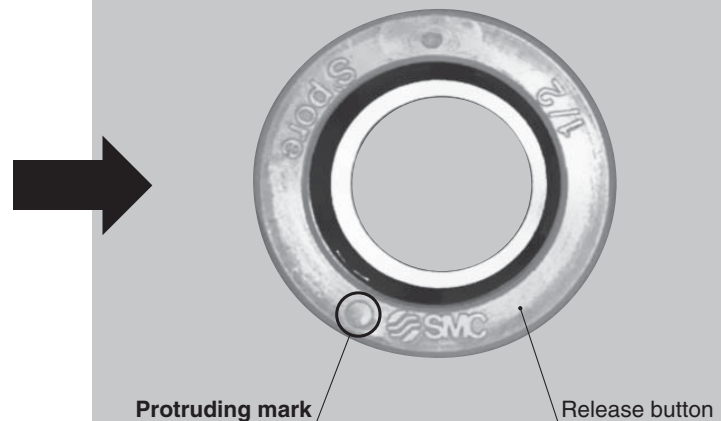

Applicable colour cap

Metric Size

Applicable tubing O.D. [mm]	Model	Ø D1	Ø D2	L	Weight [g]
Ø 2	KQ2C-02□A	6.1	3.2	2.6	0.1
Ø 3.2	KQ2C-23□A	7.3	4.3	2.6	0.1
Ø 4	KQ2C-04□A	8.3	5.2	2.6	0.1
Ø 6	KQ2C-06□A	10.3	7.2	2.6	0.1
Ø 8	KQ2C-08□A	12.8	9.2	2.6	0.1
Ø 10	KQ2C-10□A	15.2	11.2	2.7	0.1
Ø 12	KQ2C-12□A	17.6	13.2	2.7	0.1
Ø 16	KQ2C-16□A	22.4	17.2	3.2	0.2

□: B (Black), R (Red), YR (Orange), BR (Brown), Y (Yellow), G (Green), CB (Sky blue), GR (Grey), W (White), BU (Blue)

Inch Size

Applicable tubing O.D. [inch]	Model	Ø D1	Ø D2	L	Weight [g]
Ø 1/8	KQ2C-01□A	7.3	4.3	2.6	0.1
Ø 3/16	KQ2C-05□A	9	5.9	2.6	0.1
Ø 1/4	KQ2C-07□A	10.7	7.5	2.6	0.1
Ø 3/8	KQ2C-11□A	14.8	10.7	2.7	0.1
Ø 1/2	KQ2C-13□A	18.5	13.9	2.7	0.1

□: B (Black), R (Red), YR (Orange), BR (Brown), Y (Yellow), G (Green), CB (Sky blue), GR (Grey), W (White), BU (Blue)

Applicable colour cap

Metric Size

Applicable tubing O.D. [mm]	Model	Ø D1	Ø D2	L	Weight [g]
Ø 2	KQ2C-02□A	6.1	3.2	2.6	0.1
Ø 3.2	KQ2C-23□A	7.3	4.3	2.6	0.1
Ø 4	KQ2C-04□A	8.3	5.2	2.6	0.1
Ø 6	KQ2C-06□A	10.3	7.2	2.6	0.1
Ø 8	KQ2C-08□B	13.6	9.2	2.6	0.1
Ø 10	KQ2C-10□B	16.2	11.2	2.7	0.1
Ø 12	KQ2C-12□B	18.8	13.2	2.7	0.2
Ø 16	KQ2C-16□B	24.2	17.2	3.2	0.3

□: B (Black), R (Red), YR (Orange), BR (Brown), Y (Yellow), G (Green), CB (Sky blue), GR (Grey), W (White), BU (Blue)

Inch Size

Applicable tubing O.D. [inch]	Model	Ø D1	Ø D2	L	Weight [g]
Ø 1/8	KQ2C-01□A	7.3	4.3	2.6	0.1
Ø 3/16	KQ2C-05□A	9	5.9	2.6	0.1
Ø 1/4	KQ2C-07□B	11.5	7.5	2.6	0.1
Ø 3/8	KQ2C-11□B	15.7	10.7	2.7	0.1
Ø 1/2	KQ2C-13□B	19.6	13.9	2.7	0.2

□: B (Black), R (Red), YR (Orange), BR (Brown), Y (Yellow), G (Green), CB (Sky blue), GR (Grey), W (White), BU (Blue)



Applicable Fluid List

Chemical resistance of Fluoropolymer Super PFA, modified PTFE material

Chemicals in the list below are chemically inert ^(Note) to Super PFA, modified PTFE material. Possible physical effects may occur such as penetration and swelling due to temperature, pressure and chemical concentration.

To use Super PFA, modified PTFE tube in a chemical environment, tests should be performed with the same environment to ensure no problem occurs with operating environment.

1,1,1-Trichloroethane	Formic acid	Trichloroethylene
1,1,2-Trichloroethane	Ethyl formate	Trichloroacetic acid
1,2,3-Trichloropropane	Propyl formate	Toluene
1,2-Dichlorobutane	Methyl formate	Naphtha
2,4-Dichlorotoluene	Xylene	Carbon dioxide
2-chloropropane	Glycol	Nitrogen dioxide
2-nitro-2-methylpropane	Glycerine	Nitrobenzene
2-nitrobutanol	Cresol	Nitromethane
Pentabasic benzamide	Chromic acid	Carbon disulfide
Hydrochlorofluorocarbon-22	Chloroacetic acid	Piperidine
N-octadecanol	Chlorosulfonic acid	Pyridine
N-butylamine	Chloroform	Pyrogallol
o-chlorotoluene	Paraffinum liquidum	Phenol
Isobutyl adipate	Acetate	Butanol
Acetyl chloride	Amyl acetate	Phthalic acid
Acetophenone	Ethyl acetate	Hydrofluoric acid
Acetone	Potassium	Furan
Aniline	Butyl acetate	Ethyl propionate
Sulfurous acid gas	Propyl acetate	Propyl propionate
Allyl chloride	Methyl acetate	Methylpropionate
Benzoic acid	Salicylic acid	Propylene chloride
Ammonium	Sodium hypochlorite	Bromobenzene
Sulfur	Diisobutyl ketone	Hexachlorethane
Isoamyl alcohol	Diethylamine	Hexane
Isooctane	Carbon tetrachloride	Heptane
Ethanol	Dioxane	Benzyl alcohol
Ethyl ether	Cyclohexanone	Benzaldehyde
Ethylene glycol	Cyclohexane	Benzine
Ethylene chloride	Dichloroethylene	Benzoyl chloride
Ethylenediamine	Dichloropropylene	Benzonitrile
Zinc chloride	Dibutyl phthalate	Pentachloroethane
Aluminium chloride	Dimethyl ether	Boric acid
Ammonium chloride	Dimethylsulfoxide	Sodium boric acid
Calcium chloride	Dimethylformamide	Formaldehyde
Ferrous chloride	Hydrobromic acid	Acetic anhydride
Mercuric chloride	Potassium dichromate	Methanol
Stannous chloride	Bromine	Methyl ether
Ferric chloride	DI water (Pure water)	Methyl ethyl ketone
Cupric chloride	Nitric acid	Methylene chloride
Sodium chloride	Ammonium hydroxide	Ethyl butyrate
Magnesium chloride	Potassium hydroxide	Methyl butyrate
Hydrochloric acid	Sodium hydroxide	Hydrogen sulfide
Chlorine	Soap, detergent	Sulphuric acid
Aqua regia	Diethyl carbonate	Zinc sulfate
Ozone	Sodium carbonate	Ammonium sulfate
Oleic acid	Tetrachloroethane	Ferrous sulfate
Perchlorate	Tetrachloroethylene	Copper sulfate
Hydrogen peroxide	Tetrahydrofuran	Phosphoric acid
Natrium peroxide	Tetrabromoethane	Sodium phosphate
Gasoline	Triethanolamine	
Potassium permanganate	Triethylamine	

Note) "Chemically inert" means – not to cause any chemical reaction.



Applicable Fluid List

Chemical resistance of Fluoropolymer PFA material

Chemicals in the list below are chemically inert ^{Note)}, to PFA material. Possible physical effects may occur such as penetration and swelling due to temperature, pressure and chemical concentration.

To use PFA tube in a chemical environment, tests should be performed with the same environment to ensure no problem occurs with operating environment.

Acetate	Butyl stearate	Ethylene dicloride	Malic acid	Salicylic acid
Acetic anhydride	Calcium acetate	Ethylene glycol	Mercaptan	Silicate ester
Acetone	Calcium bisulfite	Ethylene oxide	Mercuric chloride	Silicone grease
Acetylene	Calcium chloride	Ethylenediamine	Mercury	Silicone oil
Acrylonitrile	Calcium hydroxide	Fatty acid	Methyl acetate	Silver nitrate
Aluminium acetate	Calcium hypochlorite	Ferric chloride	Methyl alcohol	Sodium bicarbonate
Aluminium nitrate	Calcium nitrate	Ferric nitrate	Methyl chloride	Sodium bisulfate
Aluminium bromide	Calcium sulfide	Ferric sulfate	Methyl ethyl ketone	Sodium bisulfite
Aluminium chloride	Carbon dioxide	Fluorboric acid	Methyl isobutyl ketone	Sodium hypochlorite (5%)
Aluminium fluoride	Carbon disulfide	Fluorobenzene	Methyl methacrylate	Sodium metaphosphate
Aluminium sulfate	Carbonic acid	Fluosilicic acid	Methylene dichloride	Sodium nitrate
Ammonia gas	Castor oil	Formaldehyde	Mineral oil	Sodium perborate
Ammonium carbonate	Caustic soda (30%)	Formic acid	Monochloroacetic acid	Sodium phosphate
Ammonium chloride	Cellosolve	Furfural	Monochlorobenzene	Sodium sulfite
Ammonium hydroxide	Chlorosulfonic acid	Gasoline	Monoethanolamine	Sodium thiosulfate
Ammonium nitrate	Chlorotoluene	Gelatine	Naphtha	Soybean oil
Ammonium nitrite	Chromic acid	Glauber's salt	Naphthalene	Stannic chloride
Ammonium persulfate	Citric acid	Glucose	Naphthenic acid	Stearic acid
Ammonium phosphate	Coconut oil	Glue	Natrium peroxide	Styrene
Ammonium sulfate	Copper cyanide	Glycerine	Natural gas	Sucrose solution
Amyl acetate	Copper sulfate	Grease	Nickel acetate	Sulfur
Amyl alcohol	Corn oil	Hexaldehyde	Nickel chloride	Sulfur chloride
Amyl borate	Cottonseed oil	Hexane	Nickel sulfate	Sulfuric acid (98%)
Amyl naphthalene	Creosote oil	Hexyl alcohol	Nitric acid (60%)	Sulfurous acid gas
Aniline	Cresol	Hydrobromic acid	Nitrobenzene	Tannic acid
Aniline dye	Cupric chloride	Hydrochloric acid	Nitroethane	Tartaric acid
Animal oil (Lard oil)	Cyclohexane	Hydrocyanic acid	Nitromethane	Terpineol
Aqua regia	Cyclohexanol	Hydrofluoric acid (49%)	Nitropropane	Tetrachloroethane
Arsenic acid	Cyclohexanone (Anon)	Hydrofluoric acid anhydrous	Octyl alcohol	Tetraethyl lead
Asphalt	Dibutyl phthalate	Hydrogen peroxide (30%)	Oxalic acid	Tetrahydrofuran
Barium chloride	Dichlorobenzene	Hydrogen sulfide	Oxygen	Tetralin
Barium hydroxide	Diethyl sebacate	Hydroquinone	Ozone	Thionyl chloride
Barium sulfate	Diethylene glycol	Hypochlorous acid	Palmitic acid	Triacetin
Barium sulfide	Diisopropyl keton	Isobutyl alcohol	Perchlorate	Tributoxy ethyl phosphate
Beer	Diocetyl phthalate	Isooctane	Perchloroethylene	Tributyl phosphate
Beet sugar liquors	Diocetyl sebacate	Isopropyl acetate	Petroleum	Trichloroethylene
Benzaldehyde	Dipentene (Limonene)	Isopropyl alcohol	Phenol	Tricresyl phosphate
Benzine	Diphenyl	Isopropyl ether	Phosphoric acid (75%)	Triethanolamine
Benzene (Benzol)	Diphenyl oxide	Kerosene	Picric acid	Tung oil
Benzyl alcohol	Epichlorohydrin	Lead acetate	Piperidine	Turpentine oil
Benzyl benzoate	Ethanolamine	Lead nitrate	Potassium chloride	Vegetable oil
Benzyl chloride	Ethyl acetate	Lead sulfamate	Potassium dichromate	Vinegar
Borax	Ethyl acetoacetate	Linolenic acid	Potassium hydroxide	Water
Boric acid	Ethyl acrylate	Linseed oil	Potassium nitrate	Whiskey
Bromine	Ethyl alcohol	Liquid ammonia	Potassium permanganate	Xylene
Bunker oil	Ethyl benzene	LPG (Liquefied petroleum gas)	Potassium sulfate	Zeolite
Butane	Ethyl cellulose	Lubricating oil	Propyl acetate	Zinc acetate
Butter	Ethyl chloride	Magnesium chloride	Propyl alcohol	Zinc chloride
Butyl acetate	Ethyl oxalate	Magnesium hydroxide	Propylene	Zinc sulfide
Butyl acrylate	Ethyl silicate	Magnesium sulfate	Pyridine	
Butyl alcohol (Butanol)	Ethylene chlorohydrin	Maleic acid	Pyrrrole	

Note) "Chemically inert" means – not to cause any chemical reaction.



Applicable Fluid List

Chemical Resistance of Fluoropolymer FEP Material

Chemicals in the list below are chemically inert ^{Note)} to FEP material, however physical properties may be effected by temperature or pressure change.

Please make sure that operating conditions do not cause problems since the use of FEP tubing under chemical environment is unsecured.

2-nitro-2-methyl propanol	Chloroform	Nitromethane
2-nitrobutanol	Paraffinum liquidum	Perchloroethylene
Pentabasic benzamide	Allyl acetate	Perphloroxylene
N-butylamine	Ethyl acetate	Unsymmetrical dimethylhydrazine
N-octadecanol	Potassium	Hydrazine
N-butyl acetate	Butyl acetate	Pinene
O-cresol	Sodium hypochlorite	Piperidine
Di-isobutyl adipate	Carbon tetrachloride	Glacial acetic acid (Acetic acid)
Acetophenone	Dioxane	Pyridine
Acetone	Cyclohexanone	Phenol
Alniline	Cyclohexane	Phthalic acid
Abietic acid	Dimethyl ether	Dybutyl phthalate
Sulfuric chloride	Dimethylsulfoxide	Dimethyl phthalate
Isooctane	Dimethylformamide	Hydrofluoric acid
Liquid ammonia	Bromine	Naphthalene fluoride
Ethyl alcohol	DI water (Pure water)	Nitrobenzene fluoride
Ethyl ether	Nitric acid	Furan
Ethylene glycol	Mercury	Hexachlorethane
Ethylenediamine	Ammonium hydroxide	Hexane
Zinc chloride	Potassium hydroxide	Ethyl hexanoate
Aluminium chloride	Sodium hydroxide	Phenylcarbinol
Ammonium chloride	Cetane	Benzaldehyde
Calcium chloride	Soap, detergent	Benzonitrile
Sulfuric chloride	Dibutyl sebacate	Borax
Iron chloride (III)	Diethyl carbonate	Boric acid
Benzoyl chloride	Tetrachloroethylene	Formic aldehyde (Formalin)
Magnesium chloride	Tetrahydrofuran	Acrylic anhydride
Hydrochloric acid	Tetrabromoethane	Acetic anhydride
Chlorine (absolute)	Triethanolamine	Methacrylic acid
Aqua regia	Trichloroethylene	Allyl methacrylate
Ozone	Trichloroacetic acid	Vinyl methacrylate
Hydrogen peroxide	Toluene	Methyl alcohol
Natrium peroxide	Naphtha	Methyl ethyl ketone
Gasoline	Naphthalene	Methylene chloride
Permanganate	Naphthol	Sulphuric acid
Formic acid	Lead	Phosphoric acid
Xylene	Carbon dioxide	Iron phosphate (III)
Chromic acid	Nitrogen dioxide	Tri-n-butyl phosphate
Chlorosulfonic acid	Nitrobenzene	Tricresyl phosphate

Note) "Chemically inert" means – not to cause any chemical reaction.



Series TL/TIL/TLM/TILM/TD/TID/TH/TH

Tubing/Precautions

Be sure to read this before handling.

Selection

⚠ Warning

1. Confirm the specifications.

Products represented in this catalogue are designed only for use in compressed air systems (including vacuum). Do not operate at pressures or temperatures, etc., beyond the range of specifications, as this can cause damage or malfunction. (Refer to the specifications.)

2. In case of using the product for medical care

This product is designed for use with compressed air system applications for medical care purposes. Do not use in contact with human bodily fluids, body tissues or transfer applications to a human living body.

⚠ Caution

1. Do not use in locations where the connecting threads and tubing connection will slide or rotate.

The connecting threads and tubing connection will come apart under these conditions.

2. Use tubing at or above the minimum bending radius. Using below the minimum bending radius can cause breakage or flattening of the tubing.

3. Never use the tubing for anything flammable, explosive or toxic such as gas, fuel gas, or cooling mediums etc.

Because the contents may penetrate outward.

4. Use the fittings applicable to the tubing size.

Mounting

⚠ Caution

1. Confirm model no., size, etc. before installing.

Check tubing for damage, gouges, cracks, etc.

[TLM/TILM]

The TLM and TILM series do not have the model number displayed on the product due to the resin material used. If tubing without a model label is mixed with other tubing which also does not have a model label, it is impossible to identify the model. Please avoid mixing the products with other models while it is being used and/or stored.

2. When tubing is connected, consider factors such as changes in the tubing length due to pressure, and allow sufficient leeway.

3. Do not apply unnecessary forces such as twisting, pulling, moment loads, etc. on fittings or tubing.

This will cause damage to fittings and will crush, burst or release tubing.

4. Mount so that tubing is not damaged due to tangling and abrasion.

This can cause flattening, bursting or disconnection of tubing, etc.

Piping

⚠ Caution

1. Preparation before piping

Before piping is connected, it should be thoroughly blown out with air (flushing) or washed to remove chips, cutting oil and other debris from inside the pipe. Not allowing chips of the piping thread or the seal material to go in.

Air Supply

⚠ Warning

1. Types of fluid

This product is designed for use with compressed air.

2. In case of excessive condensation

Excessive condensation in a compressed air system may cause pneumatic equipment to malfunction. Installation of an air dryer, water separator before filter is recommended.

3. Drain flushing

If condensation in the drain bowl is not emptied on a regular basis, the bowl will overflow and allow the condensation to enter the compressed air lines. It causes malfunction of pneumatic devices.

If the drain bowl is difficult to check and remove, installation of a drain bowl with an auto drain option is recommended. For compressed air quality, refer to SMC's "Air Cleaning Equipment" catalogue.

Operating Environment

⚠ Warning

1. Do not use in locations having an explosive atmosphere.

2. Do not operate in locations where vibration or impact occurs.

3. In locations near heat sources, block off radiated heat.

Maintenance

⚠ Caution

1. Reform periodic inspections to check the following problems and replace tubing, if necessary.

- 1) Cracks, gouges, wearing, corrosion
- 2) Air leakage
- 3) Twists or crushing of tubing
- 4) Hardening, deterioration, softening of tubing

2. Do not repair or patch the replaced tubing or fittings for reuse.

3. When using insert or miniature fittings over a long period, some leakage may occur due to age deterioration of the materials. If any leakage is detected, correct the problem by additional tightening.

If tightening becomes ineffective, replace the fittings with a new product immediately.



Series KK130

Specific Product Precautions 1

Be sure to read this before handling. Refer to page 327 for Safety Instructions, pages 329 to 332 for Fittings and Tubing Precautions.

Selection

Warning

1. Make sure to confirm the specifications.

Do not use with pressures or temperatures outside the range of specifications, as this may result in damage and malfunction. (Refer to the specifications on page 93.) SMC takes no responsibility for damage incurred by use in excess of the specification range.

2. Prohibition of disassembly and modification

Do not disassemble or modify (including additional machining) the main body. False use may cause an injury or accident.

3. Confirm that PTFE can be used in application.

Thread sealant contains PTFE (polytetrafluoroethylene) powder. Confirm if the use of it may cause any adverse effect on the system.

4. Cannot be used as a stop valve that requires zero leakage.

A certain amount of leakage is allowed during operation.

5. Refer to the table below for whether the S coupler can be connected.

Series	KK	KKH	KKA	KKG	KK13	KK130
KK13	—	—	—	—	○	○
KK130	—	—	—	—	○	○

When the KK130 series is connected to other companies' products, confirm manufacturers and other information before using it.

Caution

1. When connecting the plug to the socket, select the series suitable for the connection.

If the series are not matched, they cannot be connected. Mismatches will cause leakage, damage, and disconnection of the plug. Inserting a plug other than the specialized plug into the socket may result in equipment damage.

2. Do not rotate or turn the S coupler and piping to which it is connected.

The connection of the piping might be damaged or come undone.

3. Do not use couplers with flammable, explosive, or toxic substances, such as gas, gas fuel, and refrigerant.

They may leak from the S coupler or from inside the tubing to the outside.

4. Operate with a surge pressure of no more than the maximum operating pressure.

If the surge pressure exceeds the maximum operating pressure, it will cause damage to couplers and tubing.

5. Do not use the S coupler with water or steam.

Corrosion of the metal material and deterioration of the sealing material may result from long-term use with water or steam.

6. The tube bending radius in the vicinity of the fitting should be at least the minimum bending radius of the tube.

If the bending radius is less than the minimum value, fittings may damage, or tube may crack or be crushed. The minimum bending radius, with the exception of TU polyurethane tube, TUH hard polyurethane tube, TUS soft polyurethane tube, TRBU FR double layer polyurethane tube, TH FEP tube, TL PFA tube, TD modified PTFE tube, is measured as following in accordance with JIS B 8381-1995.

Tube deformation ratio at the minimum bending radius is obtained through the following formula, based on tube diameter and mandrel diameter by wrapping the same radius mandrel tube.

$$\eta = \left(1 - \frac{L-D}{2d}\right) \times 100$$

Here, η : Deformation ratio (%)
d: Tube O.D. [mm]
L: Measured length [mm]
D: Mandrel diameter [mm]
(Twice against the minimum bending radius)

Test temperature: 20 ±5 °C
Relative humidity: 65 ±5 %

Tube deformation ratio at the minimum bending radius

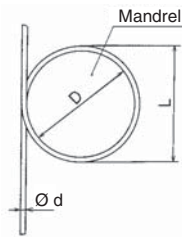

7. Applicable for air.

Consult with SMC if using other fluids.

Mounting

Warning

1. Instruction manual

Mount and operate the product after reading the instruction manual carefully and understanding its contents. Also, keep the manual where it can be referred to as necessary.

2. Ensure sufficient space for maintenance.

Be sure to allow the space required for maintenance and inspection.

3. Tightening torque

When installing the products, tighten the screw with the recommended tightening torque.

4. During use, pipe deterioration or damage to S couplers can result in disconnection of the piping and uncontrollable behavior of the piping.

To stop the piping from going out of control, use a protective cover or fix the piping in place.

5. Do not use couplers where rotation normally occurs.

The couplers may be damaged.

6. Avoid applications in which vibration or shock is directly applied to the fittings.

When mounting the S coupler to a piece of equipment that generates impact or vibration, do not connect the S coupler to the equipment directly. In that case, connect a hose whose length is 300 mm or more between the S couplers.



Series KK130

Specific Product Precautions 2

Be sure to read this before handling. Refer to page 327 for Safety Instructions, pages 329 to 332 for Fittings and Tubing Precautions.

Mounting

⚠ Warning

- S couplers with sleeve lock mechanism must be locked during operation in order to prevent sudden disconnection.**
- Install a stop valve at the supply pressure side of the socket.**
Emergency shutdown may not be possible without it.

⚠ Caution

- Preparation before piping**
Before piping is connected, it should be thoroughly blown out by air (flushed) or washed to eliminate cutting chips, cutting oil, and other debris from inside the pipe.
- Before mounting, confirm the model and size, etc.**
Also, confirm that there are no blemishes, nicks or cracks in the product.
- When connecting a pipe, consider factors such as changes in the piping length due to pressure, and allow sufficient leeway.**
- Mount so that S couplers and piping are not subjected to twisting, pulling or moment loads.**
This can cause damage to S couplers and flattening, bursting or disconnection of piping, etc.
- Mount so that piping is not damaged due to tangling and abrasion.**
This can cause flattening, bursting or disconnection of piping, etc.
- When screwing in the pipes or fittings, make sure to prevent cutting chips or the sealing material on the threaded portion of the pipe from entering the piping.**
Also, if pipe tape is used, leave about 1 thread ridge exposed at the end of the threads.

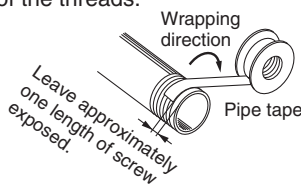

Air Supply

⚠ Warning

- Excessive drainage**
Compressed air containing large amounts of drainage can cause malfunction of pneumatic equipment. As a countermeasure, install an air dryer or water separator before the filter.
- Drain flushing**
If the drain removal from air filter is missed, drain will be flown out to the outlet side and may result in malfunction of pneumatic equipment. When removing drain is difficult, use of a filter with an auto drain is recommended.
Refer to SMC's "Air Preparation Equipment" catalogue for further details on compressed air quality.
- Use clean air.**
If the compressed air includes chemicals, synthetic oils containing organic solvents, salt or corrosive gases, etc., it can cause damage or malfunction in the system.

Air Supply

⚠ Caution

- Install an air filter.**
Install an air filter upstream, near the valve. Select an air filter with a filtration degree of 5 µm or finer.
- As a countermeasure, install an aftercooler, air dryer or water separator.**
Compressed air containing large amounts of drainage can cause malfunction of pneumatic equipment. As a countermeasure, install an aftercooler, air dryer or water separator.
- Ensure that the fluid and ambient temperature are within the specified range.**
If the fluid temperature is 5 °C or below, the moisture in the circuit could freeze, causing damage to the seals and leading to equipment malfunction. Therefore, take appropriate measures to prevent freezing.
Refer to SMC's "Air Preparation Equipment" catalog for further details on compressed air quality.

Operating Environment

⚠ Warning

- Do not use in atmospheres of corrosive gases, chemicals, sea water, water, water steam, or where there is direct contact with any of these.**
- Do not use in direct sunlight.**
- In locations near heat sources, protect against radiated heat.**
- Do not use in locations where static electric charges will be a problem.**
This may cause system failure. Consult with SMC regarding use in this kind of environment.
- Do not use in locations where spatter occurs.**
There is a danger of spatter causing a fire. Consult with SMC regarding use in this kind of environment.
- Do not use in environments where there is direct contact with liquids such as cutting oil, lubricating oil, coolant oil, or paints, etc.**
This may cause connection and release failure and/or leakage. Consult with SMC regarding use in this kind of environment.
- Do not use in locations influenced by vibrations or impacts.**
This may cause air leakage and S couplers damage. Consult with SMC regarding use in this kind of environment.
- Do not use in an environment where foreign matter such as spatter, metal powder or sand splashes onto or enters the product.**
This may cause connection and release failure and/or leakage.
- Do not use in an environment where the product is constantly exposed to water.**
Rust may occur.
- When the socket and plug are stored or not in use, make sure dust does not get stuck to them.**
This may cause connection and release failure and/or leakage.



Series KK130

Specific Product Precautions 3

Be sure to read this before handling. Refer to page 327 for Safety Instructions, pages 329 to 332 for Fittings and Tubing Precautions.

Operating Environment

Warning

11. **Do not use in places or environments where foreign matter sticks to the product or gets inside the product.**

It may cause air leakage or tube release.

Maintenance

Caution

1. Maintenance work

If handled improperly, compressed air can be dangerous. Assembly, handling, repair and element replacement of pneumatic systems should be performed by qualified personnel only.

2. Drain flushing

Remove drainage from air filters regularly.

3. Removal of equipment, and supply/exhaust of compressed air

When components are removed, first confirm that measures are in place to prevent workpieces from dropping, run-away equipment, etc. Then, cut the supply pressure and power, and exhaust all compressed air from the system using the residual pressure release function.

When machinery is restarted, proceed with caution after confirming that appropriate measures are in place to prevent cylinders from sudden movement.

4. Be absolutely sure to wear safety glasses when conducting periodic inspections.

5. Check for the following during regular maintenance, and replace components as necessary.

- a) Scratches, gouges, abrasion, corrosion, rust
- b) Leakage
- c) Twisting, flattening or distortion of tubes and hoses
- d) Hardening, deterioration or softening

6. Do not repair or patch the replaced tubing, hoses or couplers for reuse.

Do not disassemble the S coupler.

Handling

Warning

1. **When connecting the plug, hold the plug securely.**
The plug may be uncoupled due to reaction at the time of connection.
2. **When connecting the plug, pull out the sleeve straight and insert the plug completely until it stops.**
After the connection, gently pull the plug to see whether it will release. If not securely inserted, the plug may pop out due to the pressure.
3. **When connecting the plug, insert it straight into the socket.**
If not inserted straight, the socket and/or plug may be damaged or cause a disconnection.
4. **When releasing the plug, hold it securely.**
When releasing the plug, hold it securely. The connection pipe may go out of control due to reacting stress and/or residual pressure on the plug side.
5. **Do not press the inside of the socket with an incompatible plug and/or with a tool.**
The internal fluid may be ejected and cause a dangerous situation. Also, the ejecting internal fluid may cause the sealings to come apart resulting in the product not functioning.
6. **Do not connect and remove the coupler when it is pressurized and residual pressure exists.**
The coupler may fly out.
7. **Do not apply lateral load vertically to the connection direction of the plug or socket.**
This may cause leakage and damage the coupler.
8. **Never pressurize when the plug is removed.**
This may cause the connection piping to flap and be dangerous.
9. **When removing the plug, fluid in the piping leaks out.**
Handle the fluid carefully, especially when using dangerous fluids such as a fluid with high temperature and pressure. The use of a stop valve is recommended.
10. **When using a fluid with high temperature, the S coupler will be heated, too.**
Do not touch the coupler to prevent burning.
11. **When sleeve lock mechanism is provided, do not apply pressure when rotating the sleeve.**
If it is pressurized, the detent of the locked and released position may become unclear due to the pressure.
12. **Do not disassemble the S coupler.**



Series KK130

Specific Product Precautions 4

Be sure to read this before handling. Refer to page 327 for Safety Instructions, pages 329 to 332 for Fittings and Tubing Precautions.

Plug Insertion Force in Pressurized Condition

Insertion Force of Series KK130

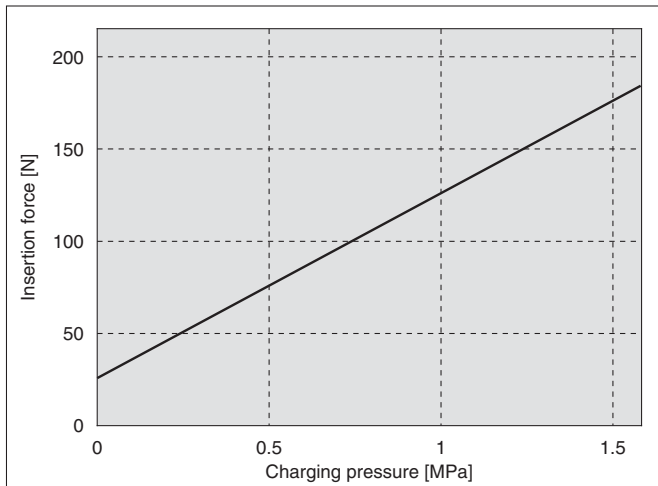

Handling of Barb Fittings and Nut Fittings

⚠ Caution

- 1. Prepare a hose band separately when using a barb fitting.**
If the hose band is not used, the hose may come off.
- 2. When using a nut fitting, insert the hose all the way to the end and securely tighten it with the nut.**
When the insertion of the hose or the tightening of the nut are not sufficient, the hose may come off.
- 3. Disconnection may occur depending on the material or the O.D. accuracy of the hose; therefore be sure to confirm the applicability of the hose.**

Handling of Thread Type

⚠ Caution

- 1. Screw the fitting into the hexagonal face of the S coupler, applying the appropriate wrench as close to the thread as possible.**

Place the wrench as close as possible to the thread. Do not apply pliers and pipe wrench to any other part other than the wrench flats. This may cause breakage or leakage.

- 2. Tightening torque**

Tighten fittings with sealant using the proper tightening torques in the table below. As a rule, they should be tightened 2 to 3 turns with a tool after first tightening by hand.

Connection thread size	Proper tightening torque [N·m]
NPT, R, Rc 1/8	7 to 9
NPT, R, Rc 1/4	12 to 14
NPT, R, Rc 3/8	22 to 24
NPT, R, Rc 1/2	28 to 30

- 3. When a fitting is over tightened, more of the sealant material is squeezed out.**

Remove the squeezed out sealant material.

- 4. When tightening is not sufficient, it will cause sealing failure or a loose fitting.**

- 5. Re-using**

- 1) Normally, a fitting with sealant can be re-used 2 to 3 times.
- 2) Remove the sealant material that is separated and adhering to a removed fitting with air blow, etc. If the separated sealant enters into nearby equipment, it will cause air leakage or malfunction.
- 3) When the sealant is no longer effective, wrap pipe tape over the sealant material and re-use the fitting. Do not use a sealant material other than pipe tape.

- 6. In cases where positioning is required, turning the fitting in the reverse direction after tightening will cause air leakage.**



Series KK130

Specific Product Precautions 5

Be sure to read this before handling. Refer to page 327 for Safety Instructions, pages 329 to 332 for Fittings and Tubing Precautions.

Handling of One-touch Fittings

⚠ Caution

1. Do not use in locations where static electric charges will be a problem.

This may cause system failure. Consult with SMC regarding use in this kind of environment.

2. Do not use in locations where spatter occurs.

There is a danger of spatter causing a fire. Consult with SMC regarding use in this kind of environment.

3. Tube attachment/detachment for One-touch fittings

1) Attaching of tubing

(1) Take a tube having no flaws on its periphery and cut it off at a right angle. When cutting the tube, use tube cutters TK-1, 2 or 3. Do not use pinchers, nippers or scissors, etc. If cutting is done with tools other than tube cutters, the tube may become flattened, etc. This can make a secure installation impossible, and cause problems such as the tube pulling out after installation or air leakage.

(2) Polyurethane tube O.D. is swelled by applying internal pressure. As such, it may be that the tube cannot be re-inserted into a One-touch fitting. Make sure to confirm the tube O.D., and when the O.D. accuracy is more than +0.07 mm for Ø 2 and +0.15 mm for other sizes, insert into a One-touch fitting again without cutting the tube to use it. When the tube is re-inserted into a One-touch fitting, make sure to confirm that the tube is able to go through the release button smoothly.

(3) Grasp the tube and push it in slowly, inserting it securely all the way into the fitting.

(4) After inserting the tube, pull on it lightly to confirm that it will not come out. If it is not installed securely all the way into the fitting, this can cause problems such as air leakage or the tube pulling out.

2) Detaching of tubing

(1) Push in the release button sufficiently. When doing this, push the collar evenly.

(2) Pull out the tube while holding down the release button so that it does not come out. If the release button is not pressed down sufficiently, there will be increased bite on the tube and it will become more difficult to pull it out.

(3) When the removed tube is to be used again, cut off the portion which has been chewed before re-using it. If the chewed portion of the tube is used as is, this can cause trouble such as air leakage or difficulty in removing the tube.

4. Connecting products with attached metal rods

After attaching products with attached metal rods such as the KC series, to the One-touch fitting, do not use tubes, resin plugs, or reducers, etc. This may cause releasing.

5. When mounting tubes, resin plugs, metal rods etc., do not press the release button.

Also, do not press the release button unnecessarily before mounting them. This may cause those parts to come off.

Recommended piping conditions

1. When installing piping in the One-touch fitting, make sure there is sufficient slack to the tube length as per the recommended piping conditions shown in Figure 1.

Also, when binding pipes together with a unifying band, etc., make sure piping is carried out without receiving external force. (See Fig. 2.)

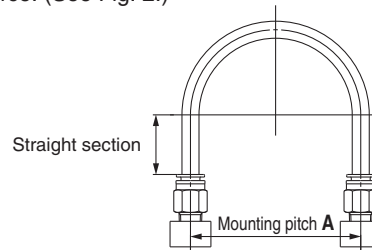

Fig. 1 Recommended piping

Unit: mm

Tube size	Mounting pitch A			Straight section
	Nylon tube	Soft nylon tube	Polyurethane tube	
Ø 6	84 or more	39 or more	39 or more	30 or more
Ø 8	112 or more	58 or more	52 or more	40 or more
Ø 10	140 or more	70 or more	69 or more	50 or more
Ø 12	168 or more	82 or more	88 or more	60 or more
Ø 1/4"	89 or more	56 or more	57 or more	32 or more
Ø 5/16"	112 or more	58 or more	52 or more	40 or more
Ø 3/8"	134 or more	76 or more	69 or more	48 or more
Ø 1/2"	178 or more	118 or more	93 or more	64 or more

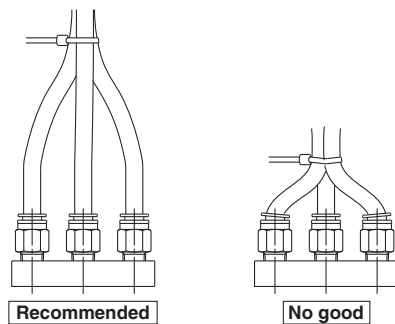

Fig. 2 When using a unifying band to bind together the pipes

Precautions on Other Tubing Brands

⚠ Caution

1. When using tubing brands other than SMC, confirm that the tube outside diameter tolerances satisfy the following specifications.

- 1) Nylon tube within ±0.1 mm
- 2) Soft nylon tube within ±0.1 mm
- 3) Polyurethane tube within +0.15 mm, within -0.2 mm

If the tube O.D. accuracy is satisfactory but measurement of the internal diameter dimensions does not match the dimensions provided by SMC, do not use.

The tube may not connect, or leaks, tube disconnection, or damage to fittings may occur.



Flow Control Equipment Precautions 1

Be sure to read this before handling.

Design/Selection

⚠ Warning

1. Confirm the specifications.

Products represented in this catalogue are designed only for use in compressed air systems (including vacuum). Do not operate at pressures or temperatures, etc., beyond the range of specifications, as this can cause damage or malfunction. (Refer to the specifications.) Please contact SMC when using a fluid other than compressed air (including vacuum). We do not guarantee against any damage if the product is used outside of the specification range.

2. Products mentioned in this catalogue are not designed for the use as stop valve with zero air leakage.

A certain amount of leakage is allowed in the product's specifications. Tightening the needle to reduce leakage to zero may result in equipment damage.

3. Do not disassemble the product or make any modifications, including additional machining.

It may cause human injury and/or an accident.

4. The flow characteristics for each product are representative values.

The flow characteristics are characteristics of each individual product. Actual values may differ depending on the piping, circuitry, pressure conditions, etc. Also, there are variations in the zero needle rotations position of the flow characteristics, depending on product specifications.

5. Sonic conductance (C) and critical pressure ratio (b) values for products are representative values.

For controlled flow direction values the needle is fully open. For free flow direction values the needle is fully closed.

6. Check if that PTFE can be used in application.

PTFE powder (Polytetrafluoroethylene resin) is included in the seal material for piping taper thread of male thread type. Confirm that the use of it will not cause any adverse effect on the system. Please contact SMC if the Material Safety Data Sheet (MSDS) is required.

Mounting

⚠ Warning

1. Operation manual

Install the product and operate it only after reading the operation manual carefully and understanding its contents. Also, keep the manual where it can be referred to as necessary.

2. Ensure sufficient space for maintenance activities.

When installing the products, allow access for maintenance.

3. Tighten threads with the proper tightening torque.

When installing the products, follow the listed torque specifications.

4. Screw the R screw into the Rc thread and NPT screw into the NPT thread.

Mounting

⚠ Warning

5. Confirm that the lock nut is tightened.

A loose lock nut may cause speed changes in the actuator.

6. Check the degree of rotation of the needle valve.

Products mentioned in this catalogue are retainer type so that the needle is not removed completely. Over rotation will cause damage.

7. Do not use tools such as pliers to rotate the knob.

It can cause idle rotation of the knob or damage.

8. Verify the air flow direction.

Mounting backwards is dangerous, because the speed adjustment needle will not work and the actuator may lurch suddenly.

9. Adjust the needle by opening the needle slowly after having closed it completely.

Loose needle valves may cause unexpected sudden actuator extension. When a needle valve is turned clockwise, it is closed and cylinder speed decreases. When a needle valve is turned counterclockwise, it is open and cylinder speed increases.

10. Do not apply excessive force or shock to the body or fittings with an impact tool.

It can cause damage or air leakage.

11. Refer to the Fittings and Tubing Precautions (pages 329 to 332) for handling One-touch fittings.

12. Tubing O.D. $\varnothing 2$

Tubing other than that from SMC cannot be used, because it may result in inability to connect the tube, air leakage after connecting the tube or disconnection of the tube.

13. To install/remove the flow control equipment, use an appropriate wrench to tighten/loosen at the supplied nut are on body B, and as close to the thread as possible.

Do not apply torque at other points as the product may be damaged. Rotate body A manually for positioning after installation.

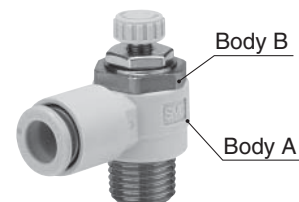

14. Do not use body A and universal type fittings for applications involving continuous rotation.

Body A and the fitting section may be damaged.



Flow Control Equipment Precautions 2

Be sure to read this before handling.

Mounting

⚠ Caution

1. Tightening the threaded portion of the connection thread M3, M5, 10-32 UNF

1) M3

First, tighten it by hand, then give it an additional 1/4 turn with a wrench. A reference value for the tightening torque is 0.4 to 0.5 N·m.
Note) AS12□1F-M3-02 should be given an approx. 1/6 turn after tightening by hand (reference value: 0.4 to 0.5 N·m).

2) M5 and 10-32UNF

First, tighten it by hand, then give it an additional 1/6 turn to 1/4 turn with a wrench. A reference value for the tightening torque is 1 to 1.5 N·m.
Note) Excessive tightening may damage the thread portion or deform the gasket and cause air leakage.
If the screw is too shallowly screwed in, it may come loose or air may leak.

2. Chamfered female thread size of the connection thread M3, M5, 10-32UNF

Confirming to ISO16030 (air pressure fluid dynamics – connection – boards and stud ends), the chamfered thread sizes shown below are recommended.

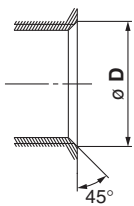

Female thread size	Chamfered port size Ø D (Recommended value)
M3	3.1 to 3.4
M5	5.1 to 5.4
10-32UNF	5.0 to 5.3

3. Proper tightening torque for a hexagon lock nut is shown in the table below. For standard installation, turn 15 to 30° using tool, after fastening by hand. Pay attention not to over torque the product. Check the dimensions for each product for the hexagonal width across flats.

Body size	Proper tightening torque [N·m]	Lock nut width across flats
M3	0.07	5 Note 1)
M5	0.3 Note 2)	7 Note 1)
1/8	1 Note 3)	10 Note 4)
1/4	1.2 Note 3)	12 Note 5)
3/8	2	14
1/2	6	17

Note 1) 4.5 for AS12□1F-M3-02, AS12□1F-M5-02 and AS1200-M3.

Note 2) 0.07 N·m for AS12□1F-M5-02, AS1□□1FM, AS12□0M and ASD230FM.

Note 3) 2 N·m for AS22□1FE-01 and AS22□1FE-02.

Note 4) 9 for AS2001F-□-3 and 12 for AS22□1FE-01.

Note 5) 14 for AS22□1FE-02.

UNI Thread Type

Mounting

⚠ Caution

1. First, tighten the threaded portion by hand, then use a proper wrench, which could be suitable for the width across flats of the hexagon body, to tighten it further at a wrench tightening angle shown below. As a reference value for the tightening torque, refer to the table below.

Connection Female Thread: Rc, NPT, NPTF

Nominal size of UNI thread	Approx. wrench tightening angle after tightened by hand [deg]	Proper tightening torque [N·m]
1/8	30 to 60	3 to 5
1/4	30 to 60	8 to 12
3/8	15 to 45	14 to 16
1/2	15 to 30	20 to 22

Connection Female Thread: G

Nominal size of UNI thread	Approx. wrench tightening angle after tightened by hand [deg]	Proper tightening torque [N·m]
1/8	30 to 45	3 to 4
1/4	15 to 30	4 to 5
3/8	15 to 30	8 to 9
1/2	15 to 30	14 to 15

2. The gasket can be recycled up to 6 to 10 times. It can be replaced easily when it has sustained damage. A broken gasket can be removed by holding it and then turning it in the same direction as loosening the thread. If gasket is difficult to remove, cut it with nippers, etc. In such a case, use caution not to scratch the seat face because the seat face of 45° gasket of fitting is the sealing face.
3. Please consult with SMC if using for other fluids than air.
4. Other precautions on handling, etc. are the same as those for One-touch fittings.

Chamfered area for female thread (Recommended value)

By chamfering as shown in the following table, machining of threads is easier and effective for burr prevention.

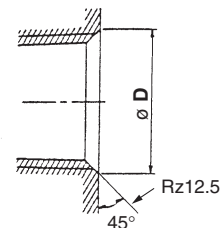

Nominal thread size	Chamfered port size Ø D (Recommended value)					
	G		Rc		NPT, NPTF	
	min	max	min	max	min	max
1/16	—	—	—	—	8.2	8.4
1/8	10.2	10.6	10.2	10.4	10.5	10.7
1/4	13.6	14.0	13.6	13.8	14.1	14.3
3/8	17.1	17.5	17.1	17.3	17.4	17.6
1/2	21.4	21.8	21.4	21.6	21.7	21.9



Flow Control Equipment Precautions 3

Be sure to read this before handling.

With Sealant Type

Piping

⚠ Caution

1. First, tighten the fitting by hand, then use a wrench appropriate for the hexagon flats of the body to tighten it a further two or three turns. As a reference value for the tightening torque, refer to the table below. Check the dimensions of each product for the hexagon width across flats.

Connection thread size (R, NPT)	[Reference value] Tightening torque [N·m]
1/8	3 to 5
1/4	8 to 12
3/8	15 to 20
1/2	20 to 25

2. If the fitting is tightened with excessive torque, a large amount of sealant will seep out. Remove the excess sealant.
3. Insufficient tightening may loosen the threads, or cause air leakage.
4. Reuse
 - 1) Normally, fittings with a sealant can be reused 2 to 3 times.
 - 2) To prevent air leakage through the sealant, remove any loose sealant stuck to the fitting by blowing air over the threaded portion.
 - 3) If the sealant no longer provides effective sealing, wrap sealing tape over the sealant before reusing. Do not use the sealant in any form other than a tape type.
5. Once the fitting has been tightened, backing it out to its original position often causes the sealant to become defective. Air leakage will occur.

Piping

⚠ Caution

1. Refer to the Fittings and Tubing Precautions (pages 329 to 332) for handling One-touch fittings.
2. Preparation before piping
Before piping is connected, it should be thoroughly blown out with air (flushing) or washed to remove chips, cutting oil and other debris from inside the pipe.
3. Wrapping of pipe tape
When screwing piping or fittings into ports, ensure that chips from the pipe threads or sealing material do not enter the piping. Also, if pipe tape is used, leave 1 thread ridge exposed at the end of the threads.

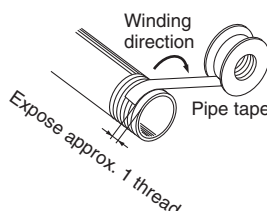

Air Supply

⚠ Warning

1. Type of fluids

Please consult with SMC when using the product in applications other than compressed air.

2. When there is a large amount of drainage.

Compressed air containing a large amount of drainage can cause malfunction of pneumatic equipment. An air dryer or water separator should be installed upstream from filters.

3. Drain flushing

If condensation in the drain bowl is not emptied on a regular basis, the bowl will overflow and allow the condensation to enter the compressed air lines. It causes malfunction of pneumatic equipment.

If the drain bowl is difficult to check and remove, installation of a drain bowl with an auto drain option is recommended.

For compressed air quality, refer to www.smc.eu.

4. Use clean air.

Do not use compressed air that contains chemicals, synthetic oils including organic solvents, salt or corrosive gases, etc., as it can cause damage or malfunction.

⚠ Caution

1. Install an air filter.

Install an air filter upstream near the valve. Select an air filter with a filtration size of 5 µm or smaller.

2. Take measures to ensure air quality, such as by installing an aftercooler, air dryer, or water separator.

Compressed air that contains a large amount of drainage can cause malfunction of pneumatic equipment such as flow control equipment. Therefore, take appropriate measures to ensure air quality, such as by providing an aftercooler, air dryer, or water separator.

3. Ensure that the fluid and ambient temperature are within the specified range.

If the fluid temperature is 5 °C or less, the moisture in the circuit could freeze, causing damage to the seals and leading to equipment malfunction. Therefore, take appropriate measures to prevent freezing.

For compressed air quality, refer to www.smc.eu.



Flow Control Equipment Precautions 4

Be sure to read this before handling.

Operating Environment

Warning

1. **Do not use in an atmosphere having corrosive gases, chemicals, sea water, water, water steam, or where there is direct contact with any of these.**

Refer to each construction drawing on the flow control equipment material.

2. **Do not expose the product to direct sunlight for an extended period of time.**
3. **Do not use in a place subject to heavy vibration and/or shock.**
4. **Do not mount the product in locations where it is exposed to radiant heat.**
5. **Using a flat blade screwdriver adjustable type tamper proof speed controller in locations where vibrations or impacts occur could lead to loosening of the needle. So please use a hexagon lock nut adjustable type speed controller.**

For reference, SMC has conducted vibration tests in 25G for 200 operations, and we have confirmed no loosening of the needle.

Maintenance

Warning

1. **Perform maintenance inspection according to the procedures indicated in the operation manual.**

If handled improperly, malfunction and damage of machinery or equipment may occur.

2. **Maintenance work**

If handled improperly, compressed air can be dangerous. Assembly, handling, repair and element replacement of pneumatic systems should be performed by a knowledgeable and experienced person.

3. **Drain flushing**

Remove drainage from air filters regularly.

4. **Removal of equipment, and supply/exhaust of compressed air**

When components are removed, first confirm that measures are in place to prevent workpieces from dropping, run-away equipment, etc. Then, cut off the supply pressure and electric power, and exhaust all compressed air from the system using the residual pressure release function.

When machinery is restarted, proceed with caution after confirming that appropriate measures are in place to prevent cylinders from sudden movement.



Series AS/Series AS-FS (Push-lock type) Specific Product Precautions 1

Be sure to read this before handling. Refer to page 327 for Safety Instructions.

Mounting

Warning

1. After pushing the knob down to lock, confirm that it is locked.

It should not be possible to rotate the knob to the right or to the left. If the knob is pulled with force, it may break. Do not pull the knob with excessive force.



2. To install/remove the product, use an appropriate wrench to tighten/loosen at the supplied nut on body B.

Do not apply torque at other points as the product may be damaged. Rotate body A manually for positioning after installation.

3. Do not use body A and/or elbow body for applications involving continuous rotation.

Body A and the fitting section may be damaged.

Elbow

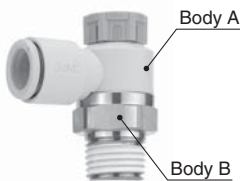

Universal

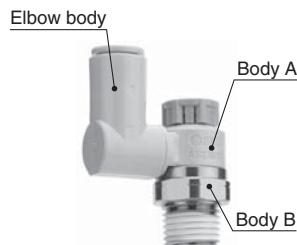

Caution

For M5

Tightening method

First, tighten it by hand, then give it an additional 1/6 turn to 1/4 turn with a wrench. A reference value for the tightening torque is 1 to 1.5 N·m.

Note) Excessive tightening may damage the thread portion or deform the gasket and cause air leakage.

If the screw is too shallowly screwed in, it may come loose or air may leak.

Chamfered area for female thread

1. Conforming to ISO 16030 (air pressure fluid dynamics – connection – ports and stud ends), the chamfered dimensions shown in the table below are recommended.

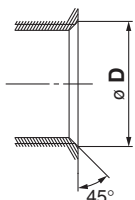

Female thread port size	Chamfered dimension $\varnothing D$ (Recommended value)
M5	5.1 to 5.4

Caution

2. This product has a stopper for fully close in rotating direction. Excess torque may break the stopper. Table below shows the maximum allowable torque of the knob.

Body size	Maximum allowable torque [N·m]
M5	0.05
1/8	0.07
1/4	0.16
3/8	0.2
1/2	0.4

3. When performing the piping work, turn the tightening tool in the horizontal direction to the hexagon across flats of the body B so that any moment is not applied to the body A. If the tool is in contact with the body A, this may cause the body B to come off.

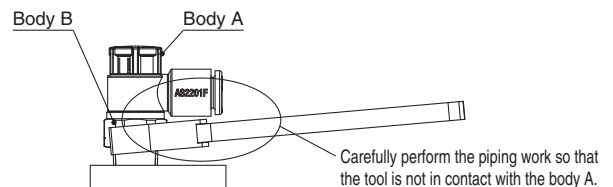

For R Thread (With sealant)

Tightening method

1. The proper tightening torques of the fittings are as shown in the table below. As a guide, tighten by hand, then turn it two or three turns with a wrench. Check the dimensions of each product for the hexagon width across flats.

Connection thread port size	Proper tightening torque [N·m]
R 1/8	3 to 5
R 1/4	8 to 12
R 3/8	15 to 20
R 1/2	20 to 25

Chamfered area for female thread

By chamfering as shown in the table below, machining of threads is easier and effective for burr prevention.

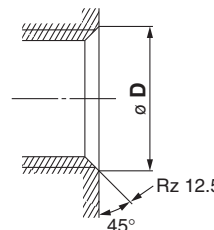

Connection thread port size	Chamfered dimension $\varnothing D$ (Recommended value)	
	Rc	
1/8	10.2 to 10.4	
1/4	13.6 to 13.8	
3/8	17.1 to 17.3	
1/2	21.4 to 21.6	

* For Uni thread, Rz 12.5 is necessary for sealing at the chamfered part.



Series AS/series AS-FS (Push-lock type) Specific Product Precautions 2

Be sure to read this before handling. Refer to page 327 for Safety Instructions.

Mounting

⚠ Caution

For Uni Thread

Tightening method

1. First, tighten the threaded portion by hand, then use a proper wrench, which could be suitable for the width across flats of the hexagon body, to tighten it further at a wrench tightening angle shown in the table below. For a tightening torque guide, refer to the table below.

Connection Female Thread: Rc, NPT, NPTF

Uni thread port size	Wrench tightening angle after tightened by hand [deg]	Tightening torque [N·m]
1/8	30 to 60	3 to 5
1/4	30 to 60	8 to 12
3/8	15 to 45	14 to 16
1/2	15 to 30	20 to 22

Connection Female Thread: G

Uni thread port size	Wrench tightening angle after tightened by hand [deg]	Tightening torque [N·m]
1/8	30 to 45	3 to 4
1/4	15 to 30	4 to 5
3/8	15 to 30	8 to 9
1/2	15 to 30	14 to 15

2. The gasket can be reused up to 6 to 10 times.

Chamfered area for female thread

By chamfering as shown in the table below, machining of threads is easier and effective for burr prevention.

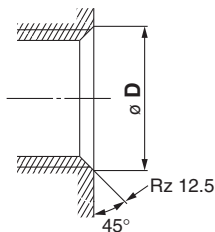

Connection thread port size	Chamfered dimension $\varnothing D$ (Recommended value)		
	G	Rc	NPT, NPTF
1/8	10.2 to 10.6	10.2 to 10.4	10.5 to 10.7
1/4	13.6 to 14.0	13.6 to 13.8	14.1 to 14.3
3/8	17.1 to 17.5	17.1 to 17.3	17.4 to 17.6
1/2	21.4 to 21.8	21.4 to 21.6	21.7 to 21.9

* For Uni thread, Rz 12.5 is necessary for sealing at the chamfered part.



Series AN

Specific Product Precautions (Silencers)

Be sure to read this before handling.

Design

⚠ Warning

1. The exhaust port could become blocked by the clogging of the exhaust cleaner.

Therefore, make sure to provide a safe design so as not to cause the whole system to malfunction.

⚠ Caution

1. The silencer is intended to reduce the noise of exhaust air of the compressed air emitted from pneumatic equipment.

Noises other than exhaust air (noise generated inside piping, noise generated by vibration of equipment, noise of switching valves, etc.) cannot be reduced.

Take appropriate measures to find the cause of noises other than those generated by exhaust air.

The product does not function as a filter. Do not use the product as a filter regardless of negative and positive pressures.

2. If the compressed air supply is contaminated with fluids such as oil and oil mist, such fluids will be dispersed to the environment.

In such a case, an exhaust cleaner is recommended to recover fluids and reduce noise.

3. The silencing effect could vary depending on the pneumatic circuit or the pressure that is used.

Selection

⚠ Caution

1. When selecting the silencer, the sonic conductance* (including combined sonic conductance) of the silencer should be larger than that of the solenoid valve.

*Sonic conductance C [$\text{dm}^3/(\text{s}\cdot\text{bar})$] = Effective area [mm^2] \div 5

2. Use within the range of specifications.

Operating Environment

⚠ Warning

1. Do not use in an atmosphere having corrosive gases, chemicals, sea water, water, water steam, or where there is direct contact with any of these.
Refer to the construction drawings for silencer materials.
2. Avoid exposure to direct sunlight.
3. Do not operate in locations where vibration or impact occurs.
4. Do not use the product in locations where it is near heat sources and exposed to radiation heat.
5. Do not use in an environment where the product is exposed to cutting oil, lubricating oil, or coolant, etc. If it is used in an environment where there is possible contact with cutting oil, lubricating oil, or coolant, exercise preventive measures.
6. Do not use in an environment where foreign matter may stick to the product or get mixed in the product's interior.
It may result in clogging at an early stage, coming off or causing damage.

Mounting

⚠ Caution

1. If the silencer body (case) is made of plastic and is tightened too much, the silencer may be damaged.
2. Tightening by using a pipe wrench or pliers may cause damage to the silencer. This method is not recommended.

Please follow the procedures below for mounting.

■When the body (case) is made of resin

Hold the tip of the main body (the side without thread) and screw it in. At the point where the thread begins to feel tight, use a wrench on the hexagonal flats to tighten an additional 1/4 turn.

For the model without the hexagonal flats, be sure to securely tighten by hand. For the model with the M-thread, tighten the tip of the main body securely by hand until it is in contact with the end face, and then retighten it by hand. At this time, note that the retightening amount should be 30° or less.

■For BC elements

Hold the tip of the main body (the side without thread) with your fingers and screw it in tightly.

Do not hold the sintered metal part with a wrench, etc. to tighten.

■When the main body is made of metal (Except BC elements)

Within the recommended tightening torque shown in the chart below, use a wrench on the hexagonal flats and tighten.

Tightening by using a pipe wrench or pliers may cause damage to the silencer. This method is not recommended.

Tightening Torques for Silencers

Connection thread	Tightening torque (N·m)
R 1/4	12 to 14
R 3/8	22 to 24
R 1/2	28 to 30
R 3/4	28 to 30
R 1	36 to 38
R 1 1/4	40 to 42
R 1 1/2	48 to 50
R 2	48 to 50

3. Make sure not to apply a lateral load to the body during or after the installation.
4. When the silencer body is loosened by vibration, etc. of equipment on which a silencer is assembled, apply glue to threads to prevent loosening and reattach.

Maintenance

⚠ Caution

1. Never disassemble the silencer.
The silencing material is not replaceable.
2. If the exhaust speed drops and the system performance decreases due to clogging, replace with a new silencer.
Make sure to verify the operating conditions of the actuator at least once a day.
3. If operation continues when it is clogged, breakage can result.

Pneumatic Piping Equipment

Model Index (Alphanumerical Order)

A

AKB	Bushing Type Check Valve	P.256
AKH	Check Valve with One-touch Fittings	P.256
AN	Compact Resin Type/Male Thread	P.321
AN-C	Compact Resin Type/ One-touch Fitting Connection	P.321
AN□00	Metal Body Type	P.322
AN□02	High Noise Reduction Type	P.323
AN1□□-□	BC Sintered Body Type	P.323
ANA1	40 dB (A): High Noise Reduction Type	P.324
ANB1	38 dB (A): High Noise Reduction Type	P.324
AQ□F	Quick Exhaust Valve with One-touch Fittings	P.255
AS-DPP00092	Speed Controller with One-touch Fittings/ Centralized Piping Type (Made to Order)	P.213
AS-DPP00093	Speed Controller with One-touch Fittings/ Centralized Piping Type (Made to Order)	P.213
AS-FG	Stainless steel In-line Type (Push lock type)	P.231
AS-FS	In-line Type Speed controller with Indicator	P.198
AS-FSG	With indicator/Stainless steel In-line Type (Push lock type)	P.230
AS-X737	All Metal Exterior, Speed Controller	P.210
AS□□□1F	Elbow Type/Universal Type Speed Controller	P.199
AS□□□1F-A	Elbow Type/Universal Type Speed Controller (Push-lock type)	P.191
AS□□□1F-A	Elbow Type/Universal Type Speed Controller (Push-lock type), (Face Seal)	P.193
AS□□□1F-D	Speed Controller Adjustable by Flat Head Screwdriver Elbow Type/Universal Type	P.243
AS□□□1F-T	Tamper Proof Speed Controller Elbow Type/Universal Type	P.245
AS□□□1F-U□	Speed Controller with Uni One-touch Fitting Elbow Type/Universal Type	P.219
AS□□□1F-U□-A	Speed Controller with Uni One-touch Fitting (Push-lock type)	P.215
AS□□□1FE	Speed Controller with Residual Pressure Release Valve Elbow Type/Universal Type	P.221
AS□□□1FG	Stainless Steel: Speed Controller with One-touch Fitting Elbow Type/Universal Type	P.227
AS□□□1FG-A	Stainless Steel: Speed Controller with One-touch Fitting (Push-lock type)	P.223
AS□□□1FM	Speed Controller for Low Speed Operation with One-touch Fitting Elbow Type/Universal Type	P.237
AS□□0P	Plug-in Type Speed Controller	P.205
AS□1F-3	In-line Type/Panel Mount Type	P.212
AS□1F-D	Speed Controller Adjustable by Flat Head Screwdriver In-line Type	P.243
AS□1F-T	Tamper Proof Speed Controller In-line Type	P.247
AS□1FG	Stainless Steel: Speed Controller with One-touch Fitting In-line Type	P.231
AS□1FM	Speed Controller for Low Speed Operation In-line Type	P.239
AS□2□1-F	Elbow Type (Metal body) Speed Controller	P.207
AS□2□1F-W2	Flame Resistant (Equivalent to UL-94 standard V-0) Speed Controller	P.203
AS□2□1F-W2D	Flame Resistant/Elbow type Screwdriver Adjustable	P.209
AS□2□1FPG	Clean Speed Controllers with One-touch Fittings Elbow Type (Stainless steel)	P.235
AS□2□1FPQ	Clean Speed Controllers with One-touch Fittings Elbow Type (Brass)	P.235
AS□2□1FS	Elbow/Universal Type, Speed Controller with Indicator	P.196

AS□2□1FS-U□	Speed Controller with Indicator/Uni Thread Type (Push-lock type)	P.217
AS□2□1FSG	Stainless Steel: Speed Controller with Indicator (Push-lock type)	P.230
AS□2F	In-line Type Speed Controller	P.211
AS□2F-A	Elbow Type/Universal Type In-line Type	P.195
ASD□30F	Dual Speed Controller Universal Type	P.214
ASD□30F-D	Dual Speed Controller Adjustable by Flat Head Screwdriver Universal Type	P.244
ASD□30F-T	Tamper Proof Dual Speed Controller Universal Type	P.248
ASD□30FG	Stainless Steel: Dual Speed Controller with One-touch Fitting Universal Type	P.232
ASD□30FM	Dual Speed Controller for Low Speed Operation Universal Type	P.240
ASG	Stainless Steel 316 Series Speed Controller	P.233
ASN2	Metering Valve with Silencer	P.255
ASP□30F	Speed Controller with Pilot Check Valve Universal Type	P.249
ASQ	Air Saving Valve Flow Valve	P.252
ASR	Air Saving Valve Pressure Valve	P.252
ASV	Speed Exhaust Controller Elbow Type/Tee Type	P.250
AS-R/AS-Q	Air Saving Speed Controller Elbow Type	P.251

D

DL	Self-align Fittings (Metric size) Connection Thread: R, Rc	P.90
DM	Multi-connector	P.103
DMK	Multi-connector with One-touch Fittings	P.105

H

H	Self-align Fittings (Metric size) Connection Thread: R, Rc	P.90
----------	---	-------------

I

INA-14-□	Check Valve (Made to Order)	P.256
INA-14-290	Check Valve (Made to Order)	P.256
IDK	Moisture Control Tube	P.282

K

KA	Antistatic One-touch Fittings Connection Thread: M, Uni thread	P.125
KB	Piping Module	P.113
KC	Self-seal Fittings (Metric size) Connection Thread: M, R, Rc	P.93
KDM	Inch-size Rectangular Multi-connector	P.107
KE□	Residual Pressure Release Valve with One-touch Fittings	P.254
KF	Insert Fittings (Metric size) Connection Thread: R	P.81
KFG2	Stainless Steel 316 Insert Fittings (Metric size) Connection Thread: R, Rc	P.140
KG	Stainless Steel One-touch Fittings Connection Thread: M5, R, Rc	P.133

Pneumatic Piping Equipment

Model Index (Alphanumerical Order)

KK	S Couplers	P.96
KK130	S Couplers	P.101
KKA	S Couplers Stainless steel type	P.146
KKH	S Couplers	P.99
KM	One-touch Fittings/Manifold (Metric size) Connection thread: R, Rc	P.78
KN	Nozzles for Blowing	P.320
KP	Clean One-touch Fittings (for blowing)	P.150
KPG	Clean One-touch Fittings (for drive system air piping: Stainless steel)	P.153
KPQ	Clean One-touch Fittings (for drive system air piping: Brass)	P.153
KQ2	One-touch Fittings (Metric size) Connection Thread: M, R, Rc	P.36
KQ2□-□P	Face seal One-touch Fittings (Metric size) Connection Thread: R, Rc	P.50
KQ2□-U□	Uni One-touch Fittings (Metric size) Connection Thread: Rc, G, NPT, NPTF	P.63
KQB2	Metal One-touch Fittings (Metric size) Connection Thread: M5, R, Rc	P.68
KQG2	Stainless Steel 316 One-touch Fittings (Metric size) Connection Thread: M5, R, Rc	P.128
KR-W2	Flame Resistant (Equivalent to UL-94 standard V-0) FR One-touch Fittings	P.118
KRM	Flame Resistant (Equivalent to UL-94 standard V-0) FR One-touch Fittings Manifold	P.123
KS	Rotary One-touch Fittings (Standard) Connection Thread: M, R	P.76
KX	Rotary One-touch Fittings (High speed) Connection Thread: M, R	P.76

L

L	Self-align Fittings (Metric size) Connection Thread: R, Rc	P.90
LL	Self-align Fittings (Metric size) Connection Thread: R, Rc	P.90
LQ1	Fluoropolymer Fittings Connection Thread: R, Rc, NPT	P.156
LQ3	Fluoropolymer Fittings/Flare Type Connection Thread: R, Rc, NPT	P.172
LQHB	Fluoropolymer Bore Through Connector Connection Thread: R, NPT	P.183

M

M	Miniature Fittings (Metric size) Connection Thread: M3, M5, R1/8	P.85
MS	Miniature Fittings/Stainless Steel 316 (Metric size) Connection Thread: M5, R1/8	P.143
MQR	Rotary Joint	P.109

T

T	Nylon Tubing	P.260
TAS	Antistatic Soft Nylon Tubing	P.295
TAU	Antistatic Polyurethane Tubing	P.296
TB	Tube Stand	P.312
TBR	Tube Reel	P.312
TCU	Polyurethane Coil Tubing	P.273
TD	Soft Fluoropolymer Tubing (Metric size)	P.305

TFU	Polyurethane Flat Tubing	P.275
TG	Tube Releasing Tool	P.312
TH	FEP Tubing (Fluoropolymer) (Metric size)	P.303
TID	Soft Fluoropolymer Tubing (Inch-size)	P.305
TIH	FEP Tubing (Fluoropolymer) (Inch-size)	P.303
TIL	Fluoropolymer Tubing (Inch-size)	P.297
TILM	Fluoropolymer Tubing (PFA) (Inch-size)	P.299
TK	Tube Cutter	P.311
TKS	Double Layer Tube Stripper	P.288
TL	Fluoropolymer Tubing (Metric size)	P.297
TLM	Fluoropolymer Tubing (PFA) (Metric size)	P.299
TM	Multi-tube Holder	P.311
TMA	Multi-holder	P.254
TMH	Holder	P.254
TPH	Clean Tubing: Polyolefin Tubing	P.307
TPS	Clean Tubing: Soft Polyolefin Tubing	P.309
TQ	2-Layer Soft Fluoropolymer Tubing	P.293
TRB	Flame Resistant (Equivalent to UL-94 standard V-0)/ FR Double Layer Tubing	P.287
TRBU	Flame Resistant (Equivalent to UL-94 standard V-0)/ FR Double Layer Polyurethane Tubing	P.289
TRS	Flame Resistant (Equivalent to UL-94 standard V-0)/ FR Soft Nylon Tubing	P.285
TRTU	Flame Resistant (Equivalent to UL-94 standard V-0)/ FR Three-layer Polyurethane Tubing	P.291
TS	Soft Nylon Tubing	P.263
TU	Polyurethane Tubing	P.265
TU	Flat Tubing: Polyurethane	P.276
TUH	Hard Polyurethane Tubing	P.269
TUS	Soft Polyurethane Tubing	P.267
TUS	Flat Tubing: Soft Polyurethane	P.267
TUZ	Wear Resistant Tubing	P.271
TUZ	Flat Tubing: Wear Resistant	P.271

V

VMG	Blow Gun	P.315
------------	----------	--------------

X

XTO-674-□□	Check Valve (Made to Order)	P.256
-------------------	--------------------------------	--------------

Other Products

25□□	Metal Case Type	P.322
-------------	-----------------	--------------

References for Thread Size and Tube Diameter

Thread size

Nominal thread size	1/8	1/4	3/8	1/2
Nominal port size	6A	8A	10A	15A

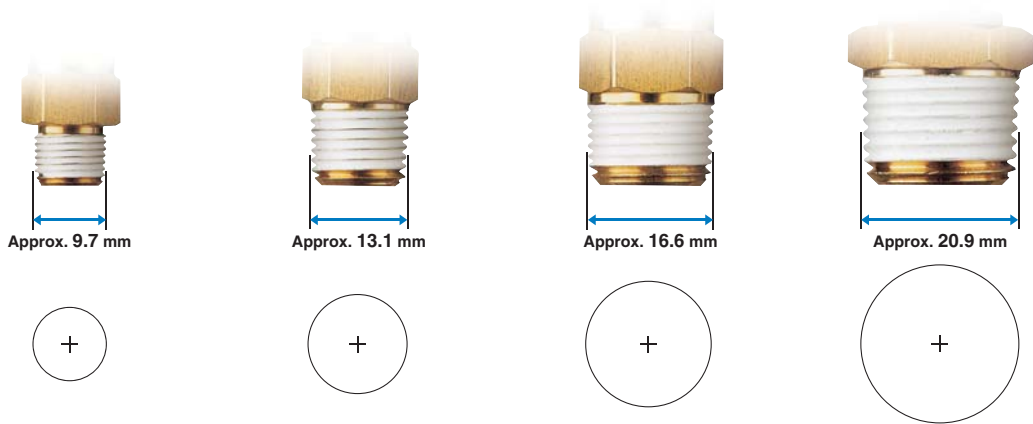

Nominal thread size	3/4	1
Nominal port size	20A	25A

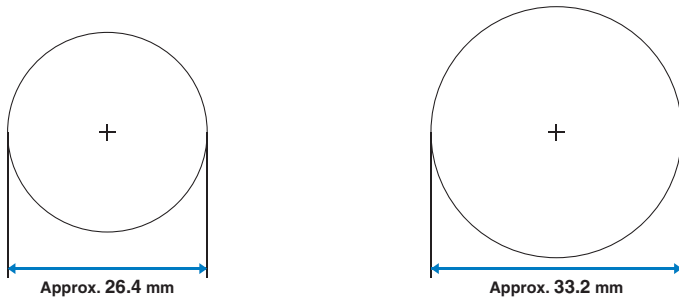

Tube diameter

O.D. 2 mm



Ø 2

O.D. 4 mm



Ø 4

O.D. 6 mm



Ø 6

O.D. 8 mm



Ø 8

O.D. 10 mm



Ø 10

O.D. 12 mm



Ø 12

O.D. 16 mm

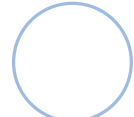

Ø 16



Expertise – Passion – Automation

SMC Corporation

Akihabara UDX 15F, 4-14-1
Sotokanda, Chiyoda-ku, Tokyo 101-0021, JAPAN
Phone: 03-5207-8249
Fax: 03-5298-5362

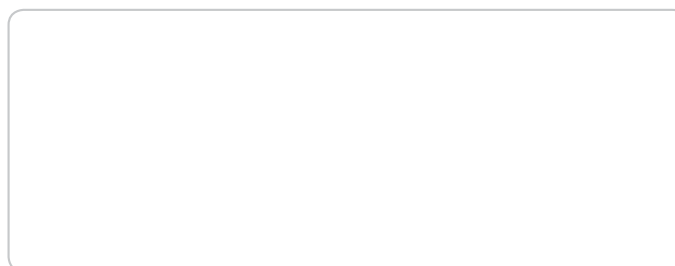

Austria	+43 (0)2262622800	www.smc.at	office@smc.at
Belgium	+32 (0)33551464	www.smc-pneumatics.be	info@smc-pneumatics.be
Bulgaria	+359 (0)2807670	www.smc.bg	office@smc.bg
Croatia	+385 (0)13707288	www.smc.hr	office@smc.hr
Czech Republic	+420 541424611	www.smc.cz	office@smc.cz
Denmark	+45 70252900	www.smc-dk.com	smc@smc-dk.com
Estonia	+372 6510370	www.smc-pneumatics.ee	smc@smc-pneumatics.ee
Finland	+358 207513513	www.smc.fi	smc-fi@smc.fi
France	+33 (0)164761000	www.smc-france.fr	info@smc-france.fr
Germany	+49 (0)61034020	www.smc.de	info@smc.de
Greece	+30 210 2717265	www.smc-hellas.gr	sales@smc-hellas.gr
Hungary	+36 23513000	www.smc.hu	office@smc.hu
Ireland	+353 (0)14039000	www.smc-pneumatics.ie	sales@smc-pneumatics.ie
Italy	+39 0292711	www.smc-italia.it	mailbox@smc-italia.it
Latvia	+371 67817700	www.smc-lv.lv	info@smc-lv.lv

Lithuania	+370 5 2308118	www.smc-lt.lt	info@smc-lt.lt
Netherlands	+31 (0)205318888	www.smc-pneumatics.nl	info@smc-pneumatics.nl
Norway	+47 67129020	www.smc-norge.no	post@smc-norge.no
Poland	+48 222119600	www.smc.pl	office@smc.pl
Portugal	+351 226166570	www.smc.eu	postpt@smc-smces.es
Romania	+40 213205111	www.smc-romania.ro	smcromania@smcromania.ro
Russia	+7 8127185445	www.smc-pneumatik.ru	info@smc-pneumatik.ru
Slovakia	+421 (0)413213212	www.smc.sk	office@smc.sk
Slovenia	+386 (0)73885412	www.smc.si	office@smc.si
Spain	+34 902184100	www.smc.eu	post@smc-smces.es
Sweden	+46 (0)86031200	www.smc.nu	post@smc.nu
Switzerland	+41 (0)523963131	www.smc.ch	info@smc.ch
Turkey	+90 212 489 0 440	www.smc-pneumatik.com.tr	info@smc-pneumatik.com.tr
UK	+44 (0)845 121 5122	www.smc-pneumatics.co.uk	sales@smc-pneumatics.co.uk