

## TLC227x, TLC227xA: Advanced LinCMOS Rail-to-Rail Operational Amplifiers

### 1 Features

- Output Swing Includes Both Supply Rails
- Low Noise:  $9 \text{ nV}/\sqrt{\text{Hz}}$  Typical at  $f = 1 \text{ kHz}$
- Low-Input Bias Current:  $1\text{-pA}$  Typical
- Fully-Specified for Both Single-Supply and Split-Supply Operation
- Common-Mode Input Voltage Range Includes Negative Rail
- High-Gain Bandwidth:  $2.2\text{-MHz}$  Typical
- High Slew Rate:  $3.6\text{-V}/\mu\text{s}$  Typical
- Low Input Offset Voltage:  $950 \mu\text{V}$  Maximum at  $T_A = 25^\circ\text{C}$
- Macromodel Included
- Performance Upgrades for the TLC272 and TLC274
- Available in Q-Temp Automotive

### 2 Applications

- White Goods (Refrigerators, Washing Machines)
- Hand-held Monitoring Systems
- Configuration Control and Print Support
- Transducer Interfaces
- Battery-Powered Applications

### 3 Description

The TLC2272 and TLC2274 are dual and quadruple operational amplifiers from Texas Instruments. Both devices exhibit rail-to-rail output performance for increased dynamic range in single- or split-supply applications. The TLC227x family offers  $2 \text{ MHz}$  of bandwidth and  $3 \text{ V}/\mu\text{s}$  of slew rate for higher-speed applications. These devices offer comparable AC performance while having better noise, input offset voltage, and power dissipation than existing CMOS operational amplifiers. The TLC227x has a noise voltage of  $9 \text{ nV}/\sqrt{\text{Hz}}$ , two times lower than competitive solutions.

The TLC227x family of devices, exhibiting high input impedance and low noise, is excellent for small-signal conditioning for high-impedance sources such as piezoelectric transducers. Because of the micropower dissipation levels, these devices work well in hand-held monitoring and remote-sensing applications. In addition, the rail-to-rail output feature, with single- or split-supplies, makes this family a great choice when interfacing with analog-to-digital converters (ADCs). For precision applications, the TLC227xA family is available with a maximum input offset voltage of  $950 \mu\text{V}$ . This family is fully characterized at  $5 \text{ V}$  and  $\pm 5 \text{ V}$ .

The TLC227x also make great upgrades to the TLC27x in standard designs. They offer increased output dynamic range, lower noise voltage, and lower input offset voltage. This enhanced feature set allows them to be used in a wider range of applications. For applications that require higher output drive and wider input voltage range, see the TLV2432 and TLV2442 devices.

If the design requires single amplifiers, see the TLV2211, TLV2221 and TLV2231 family. These devices are single rail-to-rail operational amplifiers in the SOT-23 package. Their small size and low power consumption make them ideal for high density, battery-powered equipment.

Device Information<sup>(1)</sup>

| PART NUMBER | PACKAGE    | BODY SIZE (NOM)    |
|-------------|------------|--------------------|
| TLC2272     | TSSOP (8)  | 4.40 mm x 3.00 mm  |
|             | SOIC (8)   | 3.91 mm x 4.90 mm  |
|             | SO (8)     | 5.30 mm x 6.20 mm  |
|             | PDIP (8)   | 6.35 mm x 9.81 mm  |
| TLC2274     | TSSOP (14) | 4.40 mm x 5.00 mm  |
|             | SOIC (14)  | 3.91 mm x 8.65 mm  |
|             | SO (14)    | 5.30 mm x 10.30 mm |
|             | PDIP (14)  | 6.35 mm x 19.30 mm |

(1) For all available packages, see the orderable addendum at the end of the data sheet.

Maximum Peak-to-Peak Output Voltage vs Supply Voltage

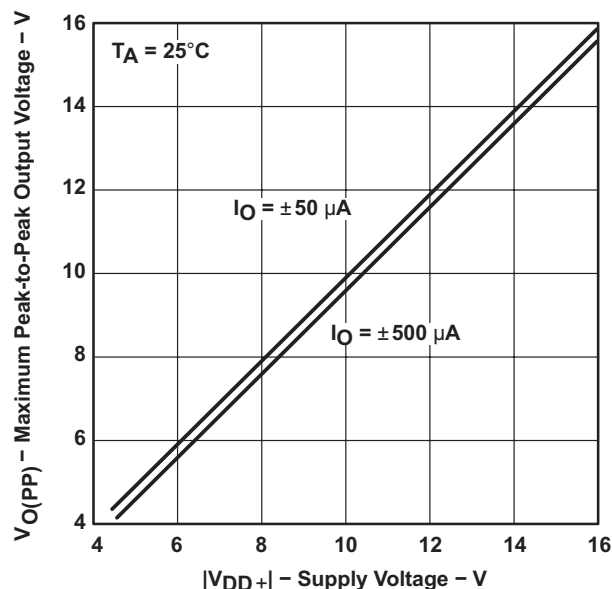

## Table of Contents

|  |           |  |           |
|--|-----------|--|-----------|
| <b>1 Features</b> .....  | <b>1</b>  | 7.1 Overview .....   | 24        |
| <b>2 Applications</b> .....  | <b>1</b>  | 7.2 Functional Block Diagram .....                                   | 24        |
| <b>3 Description</b> .....   | <b>1</b>  | 7.3 Feature Description .....  | 24        |
| <b>4 Revision History</b> .....  | <b>2</b>  | 7.4 Device Functional Modes .....                                    | 24        |
| <b>5 Pin Configuration and Functions</b> .....                                       | <b>3</b>  | <b>8 Application and Implementation</b> .....                        | <b>25</b> |
| <b>6 Specifications</b> .....  | <b>5</b>  | 8.1 Application Information .....                                    | 25        |
| 6.1 Absolute Maximum Ratings .....   | 5         | 8.2 Typical Application .....  | 26        |
| 6.2 ESD Ratings .....  | 5         | <b>9 Power Supply Recommendations</b> .....                          | <b>28</b> |
| 6.3 Recommended Operating Conditions .....   | 5         | <b>10 Layout</b> .....   | <b>29</b> |
| 6.4 Thermal Information .....  | 6         | 10.1 Layout Guidelines .....   | 29        |
| 6.5 TLC2272 and TLC2272A Electrical Characteristics<br>V <sub>DD</sub> = 5 V .....   | 6         | 10.2 Layout Example .....  | 29        |
| 6.6 TLC2272 and TLC2272A Electrical Characteristics<br>V <sub>DD±</sub> = ±5 V ..... | 8         | <b>11 Device and Documentation Support</b> .....                     | <b>30</b> |
| 6.7 TLC2274 and TLC2274A Electrical Characteristics<br>V <sub>DD</sub> = 5 V .....   | 9         | 11.1 Related Links .....   | 30        |
| 6.8 TLC2274 and TLC2274A Electrical Characteristics<br>V <sub>DD±</sub> = ±5 V ..... | 11        | 11.2 Community Resources .....                                       | 30        |
| 6.9 Typical Characteristics .....  | 13        | 11.3 Trademarks .....  | 30        |
| <b>7 Detailed Description</b> .....  | <b>24</b> | 11.4 Electrostatic Discharge Caution .....                           | 30        |
|  |           | 11.5 Glossary .....  | 30        |
|  |           | <b>12 Mechanical, Packaging, and Orderable<br/>Information</b> ..... | <b>30</b> |

## 4 Revision History

| Changes from Revision G (May 2004) to Revision H   | Page |
|--|------|
| • Added <i>Feature Description</i> section, <i>Device Functional Modes</i> , <i>Application and Implementation</i> section, <i>Power Supply Recommendations</i> section, <i>Layout</i> section, <i>Device and Documentation Support</i> section, and <i>Mechanical, Packaging, and Orderable Information</i> section. .... | 1    |
| • Added ESD Rating table for the D and PW package devices. ....  | 5    |

## 5 Pin Configuration and Functions

**TLC2272**  
 D, JG, P, or PW Package  
 8-Pin SOIC, CDIP, PDIP, or TSSOP  
 Top View

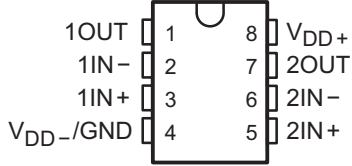

**TLC2272**  
 FK Package  
 20-Pin LCCC  
 Top View

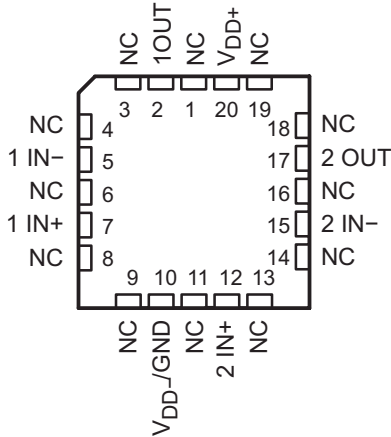

**TLC2272**  
 U Package  
 10-Pin CFP  
 Top View

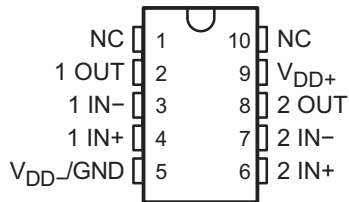

**TLC2274**  
 D, J, N, PW, or W Package  
 14-Pin SOIC, CDIP, PDIP, TSSOP, or CFP  
 Top View

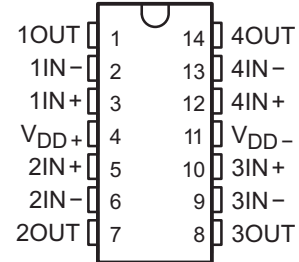

**TLC2274**  
 FK Package  
 20-Pin LCCC  
 Top View

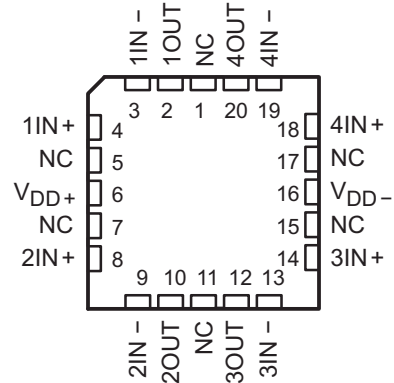

### Pin Functions

| NAME                 | PIN                |  |       |                      |                        | I/O | DESCRIPTION                    |
|----------------------|--------------------|--|-------|----------------------|------------------------|-----|--------------------------------|
|                      | NO.                |  |       |                      |                        |     |                                |
|                      | TLC2272            |  |       | TLC2274              |                        |     |                                |
|                      | D, JG, P,<br>or PW | FK   | U     | D, J, N,<br>PW, or W | FK                     |     |                                |
| 1IN+                 | 3                  | 7  | 4     | 3                    | 4                      | I   | Non-inverting input, Channel 1 |
| 1IN-                 | 2                  | 5  | 3     | 2                    | 3                      | I   | Inverting input, Channel 1     |
| 1OUT                 | 1                  | 2  | 2     | 1                    | 2                      | O   | Output, Channel 1              |
| 2IN+                 | 5                  | 12   | 6     | 5                    | 8                      | I   | Non-inverting input, Channel 2 |
| 2IN-                 | 6                  | 15   | 7     | 6                    | 9                      | I   | Inverting input, Channel 2     |
| 2OUT                 | 7                  | 17   | 8     | 7                    | 10                     | O   | Output, Channel 2              |
| 3IN+                 | —                  | —  | —     | 10                   | 14                     | I   | Non-inverting input, Channel 3 |
| 3IN-                 | —                  | —  | —     | 9                    | 13                     | I   | Inverting input, Channel 3     |
| 3OUT                 | —                  | —  | —     | 8                    | 12                     | O   | Output, Channel 3              |
| 4IN+                 | —                  | —  | —     | 12                   | 18                     | I   | Non-inverting input, Channel 4 |
| 4IN-                 | —                  | —  | —     | 13                   | 19                     | I   | Inverting input, Channel 4     |
| 4OUT                 | —                  | —  | —     | 14                   | 20                     | O   | Output, Channel 4              |
| V <sub>DD+</sub>     | 8                  | 20   | 9     | 4                    | 6                      | —   | Positive (highest) supply      |
| V <sub>DD-</sub>     | —                  | —  | —     | 11                   | 16                     | —   | Negative (lowest) supply       |
| V <sub>DD-/GND</sub> | 4                  | 10   | 5     | —                    | —                      | —   | Negative (lowest) supply       |
| NC                   | —                  | 1, 3, 4, 6, 8,<br>9, 11, 13, 14,<br>16, 18, 19 | 1, 10 | —                    | 1, 5, 7, 11,<br>15, 17 | —   | No Connection                  |

## 6 Specifications

### 6.1 Absolute Maximum Ratings

over operating free-air temperature range (unless otherwise noted)<sup>(1)</sup>

|   |                       | MIN             | MAX       | UNIT |
|---|-----------------------|-----------------|-----------|------|
| Supply voltage, $V_{DD+}$ <sup>(2)</sup>                            |                       |                 | 8         | V    |
| $V_{DD-}$ <sup>(2)</sup>  |                       | -8              |           | V    |
| Differential input voltage, $V_{ID}$ <sup>(3)</sup>                 |                       |                 | ±16       | V    |
| Input voltage, $V_I$ (any input) <sup>(2)</sup>                     |                       | $V_{DD-} - 0.3$ | $V_{DD+}$ | V    |
| Input current, $I_I$ (any input)                                    |                       |                 | ±5        | mA   |
| Output current, $I_O$   |                       |                 | ±50       | mA   |
| Total current into $V_{DD+}$  |                       |                 | ±50       | mA   |
| Total current out of $V_{DD-}$                                      |                       |                 | ±50       | mA   |
| Duration of short-circuit current at (or below) 25°C <sup>(4)</sup> |                       | Unlimited       |           |      |
| Operating free-air temperature range, $T_A$                         | C level parts         | 0               | 70        | °C   |
|   | I, Q level parts      | -40             | 125       |      |
|   | M level parts         | -55             | 125       |      |
| Lead temperature 1,6 mm (1/16 inch) from case for 10 seconds        | D, N, P or PW package |                 | 260       | °C   |
| Lead temperature 1,6 mm (1/16 inch) from case for 60 seconds        | J or U package        |                 | 300       | °C   |
| Storage temperature, $T_{stg}$                                      |                       | -65             | 150       | °C   |

- (1) Stresses beyond those listed under *Absolute Maximum Ratings* may cause permanent damage to the device. These are stress ratings only, which do not imply functional operation of the device at these or any other conditions beyond those indicated under *Recommended Operating Conditions*. Exposure to absolute-maximum-rated conditions for extended periods may affect device reliability.
- (2) All voltage values, except differential voltages, are with respect to the midpoint between  $V_{DD+}$  and  $V_{DD-}$ .
- (3) Differential voltages are at  $IN+$  with respect to  $IN-$ . Excessive current will flow if input is brought below  $V_{DD-} - 0.3$  V.
- (4) The output may be shorted to either supply. Temperature or supply voltages must be limited to ensure that the maximum dissipation rating is not exceeded.

### 6.2 ESD Ratings

|                                     |   |  | VALUE | UNIT |
|-------------------------------------|---|--|-------|------|
| $V_{(ESD)}$ Electrostatic discharge | Human-body model (HBM), per AEC Q100-002 <sup>(1)</sup> | Q-grade and M-grade devices in D and PW packages | ±2000 | V    |
|                                     | Charged-device model (CDM), per AEC Q100-011            | Q-grade and M-grade devices in D and PW packages | ±1000 |      |

- (1) AEC Q100-002 indicates that HBM stressing shall be in accordance with the ANSI/ESDA/JEDEC JS-001 specification.

### 6.3 Recommended Operating Conditions

|                                    |               | MIN       | MAX             | UNIT |
|------------------------------------|---------------|-----------|-----------------|------|
| $V_{DD±}$ Supply voltage           | C LEVEL PARTS | ±2.2      | ±8              | V    |
|                                    | I LEVEL PARTS | ±2.2      | ±8              |      |
|                                    | Q LEVEL PARTS | ±2.2      | ±8              |      |
|                                    | M LEVEL PARTS | ±2.2      | ±8              |      |
| $V_I$ Input voltage                | C LEVEL PARTS | $V_{DD-}$ | $V_{DD+} - 1.5$ | V    |
|                                    | I LEVEL PARTS | $V_{DD-}$ | $V_{DD+} - 1.5$ |      |
|                                    | Q LEVEL PARTS | $V_{DD-}$ | $V_{DD+} - 1.5$ |      |
|                                    | M LEVEL PARTS | $V_{DD-}$ | $V_{DD+} - 1.5$ |      |
| $V_{IC}$ Common-mode input voltage | C LEVEL PARTS | $V_{DD-}$ | $V_{DD+} - 1.5$ | V    |
|                                    | I LEVEL PARTS | $V_{DD-}$ | $V_{DD+} - 1.5$ |      |
|                                    | Q LEVEL PARTS | $V_{DD-}$ | $V_{DD+} - 1.5$ |      |
|                                    | M LEVEL PARTS | $V_{DD-}$ | $V_{DD+} - 1.5$ |      |

## Recommended Operating Conditions (continued)

|                |                                | MIN           | MAX | UNIT |    |
|----------------|--------------------------------|---------------|-----|------|----|
| T <sub>A</sub> | Operating free-air temperature | C LEVEL PARTS | 0   | 70   | °C |
|                |                                | I LEVEL PARTS | -40 | 125  |    |
|                |                                | Q LEVEL PARTS | -40 | 125  |    |
|                |                                | M LEVEL PARTS | -55 | 125  |    |

## 6.4 Thermal Information

| THERMAL METRIC <sup>(1)</sup> | TLC2272   |          |            |           |         | TLC2274  |          |            |           |          | UNIT |      |
|-------------------------------|---|----------|------------|-----------|---------|----------|----------|------------|-----------|----------|------|------|
|                               | D (SOIC)  | P (PDIP) | PW (TSSOP) | FK (LCCC) | U (CFP) | D (SOIC) | N (PDIP) | PW (TSSOP) | FK (LCCC) | J (CDIP) |      |      |
|                               | 8-PIN   | 8-PIN    | 8-PIN      | 20-PIN    | 10-PIN  | 14-PIN   | 14-PIN   | 14-PIN     | 20-PIN    | 14-PIN   |      |      |
| R <sub>θJA</sub>              | Junction-to-ambient thermal resistance <sup>(2)(3)</sup>    | 115.6    | 58.5       | 175.8     | —       | —        | 83.8     | —          | 111.6     | —        | —    | °C/W |
| R <sub>θJC(top)</sub>         | Junction-to-case (top) thermal resistance <sup>(2)(3)</sup> | 61.8     | 48.3       | 58.8      | 18      | 121.3    | 43.2     | 34         | 41.2      | 16       | 16.2 | °C/W |
| R <sub>θJB</sub>              | Junction-to-board thermal resistance                        | 55.9     | 35.6       | 104.3     | —       | —        | 38.4     | —          | 54.7      | —        | —    | °C/W |
| ψ <sub>JT</sub>               | Junction-to-top characterization parameter                  | 14.3     | 25.9       | 5.9       | —       | —        | 9.4      | —          | 3.9       | —        | —    | °C/W |
| ψ <sub>JB</sub>               | Junction-to-board characterization parameter                | 55.4     | 35.5       | 102.6     | —       | —        | 38.1     | —          | 53.9      | —        | —    | °C/W |
| R <sub>θJC(bot)</sub>         | Junction-to-case (bottom) thermal resistance                | —        | —          | —         | —       | 8.68     | —        | —          | —         | —        | —    | °C/W |

(1) For more information about traditional and new thermal metrics, see the *Semiconductor and IC Package Thermal Metrics* application report, [SPRA953](#).

(2) Maximum power dissipation is a function of T<sub>J(max)</sub>, θ<sub>JA</sub>, and T<sub>A</sub>. The maximum allowable power dissipation at any allowable ambient temperature is P<sub>D</sub> = (T<sub>J(max)</sub> - T<sub>A</sub>) / θ<sub>JA</sub>. Operating at the absolute maximum T<sub>J</sub> of 150°C can affect reliability.

(3) The package thermal impedance is calculated in accordance with JESD 51-7 (plastic) or MIL-STD-883 Method 1012 (ceramic).

## 6.5 TLC2272 and TLC2272A Electrical Characteristics V<sub>DD</sub> = 5 V

at specified free-air temperature, V<sub>DD</sub> = 5 V; T<sub>A</sub> = 25°C, unless otherwise noted.

| PARAMETER        | TEST CONDITIONS  | MIN                       | TYP                             | MAX   | UNIT  |    |
|------------------|--|---------------------------|---------------------------------|-------|-------|----|
| V <sub>IO</sub>  | Input offset voltage<br>V <sub>IC</sub> = 0 V, V <sub>DD±</sub> = ±2.5 V,<br>V <sub>O</sub> = 0 V, R <sub>S</sub> = 50 Ω                             | TLC2272                   | T <sub>A</sub> = 25°C           | 300   | 2500  | μV |
|                  |  | TLC2272A                  |                                 | 300   | 950   |    |
|                  |  | TLC2272                   | Full Range <sup>(1)</sup>       | 3000  |       |    |
|                  |  | TLC2272A                  |                                 | 1500  |       |    |
| α <sub>VIO</sub> | Temperature coefficient of input offset voltage<br>V <sub>IC</sub> = 0 V, V <sub>DD±</sub> = ±2.5 V, V <sub>O</sub> = 0 V, R <sub>S</sub> = 50 Ω     |                           |                                 | 2     | μV/°C |    |
|                  | Input offset voltage long-term drift <sup>(2)</sup><br>V <sub>IC</sub> = 0 V, V <sub>DD±</sub> = ±2.5 V, V <sub>O</sub> = 0 V, R <sub>S</sub> = 50 Ω |                           |                                 | 0.002 | μV/mo |    |
| I <sub>IO</sub>  | Input offset current<br>V <sub>IC</sub> = 0 V, V <sub>DD±</sub> = ±2.5 V,<br>V <sub>O</sub> = 0 V, R <sub>S</sub> = 50 Ω                             | All level parts           | T <sub>A</sub> = 25°C           | 0.5   | 60    | pA |
|                  |  | C level part              | T <sub>A</sub> = 0°C to 80°C    | 100   |       |    |
|                  |  | I level part              | T <sub>A</sub> = -40°C to 85°C  | 150   |       |    |
|                  |  | Q level part              | T <sub>A</sub> = -40°C to 125°C | 800   |       |    |
|                  |  | M level part              | T <sub>A</sub> = -55°C to 125°C | 800   |       |    |
| I <sub>IB</sub>  | Input bias current<br>V <sub>IC</sub> = 0 V, V <sub>DD±</sub> = ±2.5 V,<br>V <sub>O</sub> = 0 V, R <sub>S</sub> = 50 Ω                               | All level parts           | T <sub>A</sub> = 25°C           | 1     | 60    | pA |
|                  |  | C level part              | T <sub>A</sub> = 0°C to 80°C    | 100   |       |    |
|                  |  | I level part              | T <sub>A</sub> = -40°C to 85°C  | 150   |       |    |
|                  |  | Q level part              | T <sub>A</sub> = -40°C to 125°C | 800   |       |    |
|                  |  | M level part              | T <sub>A</sub> = -55°C to 125°C | 800   |       |    |
| V <sub>ICR</sub> | Common-mode input voltage<br>R <sub>S</sub> = 50 Ω;  V <sub>IO</sub>   ≤ 5 mV  | T <sub>A</sub> = 25°C     | -0.3                            | 2.5   | 4     | V  |
|                  |  | Full Range <sup>(1)</sup> | 0                               | 2.5   | 3.5   |    |

(1) T<sub>A</sub> = -55°C to 125°C.

(2) Typical values are based on the input offset voltage shift observed through 168 hours of operating life test at T<sub>A</sub> = 150°C extrapolated to T<sub>A</sub> = 25°C using the Arrhenius equation and assuming an activation energy of 0.96 eV.

**TLC2272 and TLC2272A Electrical Characteristics  $V_{DD} = 5\text{ V}$  (continued)**

 at specified free-air temperature,  $V_{DD} = 5\text{ V}$ ;  $T_A = 25^\circ\text{C}$ , unless otherwise noted.

| PARAMETER                                       |  | TEST CONDITIONS  |                             | MIN   | TYP       | MAX                    | UNIT     |      |
|---|--|--|-----------------------------|---|-----------|------------------------|----------|------|
| $V_{OH}$  | High-level output voltage  | $I_{OH} = -20\ \mu\text{A}$  |                             |   | 4.99      |                        | V        |      |
|   |  | $I_{OH} = -200\ \mu\text{A}$   | $T_A = 25^\circ\text{C}$    | 4.85  | 4.93      |                        |          |      |
|   |  |  | Full Range <sup>(1)</sup>   | 4.85  |           |                        |          |      |
|   |  | $I_{OH} = -1\ \text{mA}$   | $T_A = 25^\circ\text{C}$    | 4.25  | 4.65      |                        |          |      |
| Full Range <sup>(1)</sup>                       | 4.25   |  |                             |   |           |                        |          |      |
| $V_{OL}$  | Low-level output voltage   | $V_{IC} = 2.5\ \text{V}$   | $I_{OL} = 50\ \mu\text{A}$  |   |           | 0.01                   | V        |      |
|   |  |  | $I_{OL} = 500\ \mu\text{A}$ | $T_A = 25^\circ\text{C}$                        |           | 0.09                   |          | 0.15 |
|   |  |  |                             | Full Range <sup>(1)</sup>                       |           |                        |          | 0.15 |
|   |  |  | $I_{OL} = 5\ \text{mA}$     | $T_A = 25^\circ\text{C}$                        |           | 0.9                    |          | 1.5  |
| Full Range <sup>(1)</sup>                       |  |  |                             | 1.5   |           |                        |          |      |
| $A_{VD}$  | Large-signal differential voltage amplification                    | $V_{IC} = 2.5\ \text{V}$ ,<br>$V_O = 1\ \text{V to } 4\ \text{V}$ ;<br>$R_L = 10\ \text{k}\Omega^{(3)}$                    | C level part                | $T_A = 25^\circ\text{C}$                        | 15        | 35                     | V/mV     |      |
|   |  |  |                             | $T_A = 0^\circ\text{C to } 80^\circ\text{C}$    | 15        |                        |          |      |
|   |  |  | I level part                | $T_A = 25^\circ\text{C}$                        | 15        | 35                     |          |      |
|   |  |  |                             | $T_A = -40^\circ\text{C to } 85^\circ\text{C}$  | 15        |                        |          |      |
|   |  |  | Q level part                | $T_A = 25^\circ\text{C}$                        | 10        | 35                     |          |      |
|   |  |  |                             | $T_A = -40^\circ\text{C to } 125^\circ\text{C}$ | 10        |                        |          |      |
|   |  |  | M level part                | $T_A = 25^\circ\text{C}$                        | 10        | 35                     |          |      |
| $T_A = -55^\circ\text{C to } 125^\circ\text{C}$ | 10   |  |                             |   |           |                        |          |      |
|   |  | $V_{IC} = 2.5\ \text{V}$ , $V_O = 1\ \text{V to } 4\ \text{V}$ ; $R_L = 1\ \text{M}\Omega^{(3)}$                           |                             |   | 175       |                        |          |      |
| $r_{id}$  | Differential input resistance                                      |  |                             |   | $10^{12}$ |                        | $\Omega$ |      |
| $r_i$   | Common-mode input resistance                                       |  |                             |   | $10^{12}$ |                        | $\Omega$ |      |
| $c_i$   | Common-mode input capacitance                                      | $f = 10\ \text{kHz}$ , P package   |                             |   | 8         |                        | pF       |      |
| $z_o$   | Closed-loop output impedance                                       | $f = 1\ \text{MHz}$ , $A_V = 10$   |                             |   | 140       |                        | $\Omega$ |      |
| CMRR  | Common-mode rejection ratio  | $V_{IC} = 0\ \text{V to } 2.7\ \text{V}$ ,<br>$V_O = 2.5\ \text{V}$ , $R_S = 50\ \Omega$                                   | $T_A = 25^\circ\text{C}$    | 70  | 75        | dB                     |          |      |
|   |  |  | Full Range <sup>(1)</sup>   | 70  |           |                        |          |      |
| $k_{SVR}$                                       | Supply-voltage rejection ratio ( $\Delta V_{DD} / \Delta V_{IO}$ ) | $V_{DD} = 4.4\ \text{V to } 16\ \text{V}$ ,<br>$V_{IC} = V_{DD} / 2$ , no load   | $T_A = 25^\circ\text{C}$    | 80  | 95        | dB                     |          |      |
|   |  |  | Full Range <sup>(1)</sup>   | 80  |           |                        |          |      |
| $I_{DD}$  | Supply current   | $V_O = 2.5\ \text{V}$ , no load  | $T_A = 25^\circ\text{C}$    |   | 2.2       | 3                      | mA       |      |
|   |  |  | Full Range <sup>(1)</sup>   |   |           |                        |          | 3    |
| SR  | Slew rate at unity gain  | $V_O = 0.5\ \text{V to } 2.5\ \text{V}$ ,<br>$R_L = 10\ \text{k}\Omega^{(3)}$ , $C_L = 100\ \text{pF}^{(3)}$               | $T_A = 25^\circ\text{C}$    | 2.3   | 3.6       | V/ $\mu\text{s}$       |          |      |
|   |  |  | Full Range <sup>(1)</sup>   | 1.7   |           |                        |          |      |
| $V_n$   | Equivalent input noise voltage                                     | $f = 10\ \text{Hz}$<br>$f = 1\ \text{kHz}$   |                             |   | 50        | nV/ $\sqrt{\text{Hz}}$ |          |      |
|   |  |  |                             |   | 9         |                        |          |      |
| $V_{NPP}$                                       | Peak-to-peak equivalent input noise voltage                        | $f = 0.1\ \text{Hz to } 1\ \text{Hz}$<br>$f = 0.1\ \text{Hz to } 10\ \text{Hz}$  |                             |   | 1         | $\mu\text{V}$          |          |      |
|   |  |  |                             |   | 1.4       |                        |          |      |
| $I_n$   | Equivalent input noise current                                     |  |                             |   | 0.6       | fA/ $\sqrt{\text{Hz}}$ |          |      |
| THD+N   | Total harmonic distortion + noise                                  | $V_O = 0.5\ \text{V to } 2.5\ \text{V}$ ,<br>$f = 20\ \text{kHz}$ , $R_L = 10\ \text{k}\Omega^{(3)}$                       | $A_V = 1$                   |   | 0.0013%   |                        |          |      |
|   |  |  | $A_V = 10$                  |   | 0.004%    |                        |          |      |
|   |  |  | $A_V = 100$                 |   | 0.03%     |                        |          |      |
| Gain-bandwidth product                          |  | $f = 10\ \text{kHz}$ , $R_L = 10\ \text{k}\Omega^{(3)}$ , $C_L = 100\ \text{pF}^{(3)}$                                     |                             |   | 2.18      | MHz                    |          |      |
| $B_{OM}$  | Maximum output-swing bandwidth                                     | $V_{O(PP)} = 2\ \text{V}$ , $A_V = 1$ , $R_L = 10\ \text{k}\Omega^{(3)}$ , $C_L = 100\ \text{pF}^{(3)}$                    |                             |   | 1         | MHz                    |          |      |
| $t_s$   | Settling time  | $A_V = -1$ , $R_L = 10\ \text{k}\Omega^{(3)}$ ,<br>Step = $0.5\ \text{V to } 2.5\ \text{V}$ , $C_L = 100\ \text{pF}^{(3)}$ | To 0.1%                     |   | 1.5       | $\mu\text{s}$          |          |      |
|   |  |  | To 0.01%                    |   | 2.6       |                        |          |      |
| $\Phi_m$  | Phase margin at unity gain   | $R_L = 10\ \text{k}\Omega^{(3)}$ , $C_L = 100\ \text{pF}^{(3)}$  |                             |   | 50°       |                        |          |      |
| Gain margin                                     |  | $R_L = 10\ \text{k}\Omega^{(3)}$ , $C_L = 100\ \text{pF}^{(3)}$  |                             |   | 10        | dB                     |          |      |

(3) Referenced to 0 V.

## 6.6 TLC2272 and TLC2272A Electrical Characteristics $V_{DD\pm} = \pm 5\text{ V}$

at specified free-air temperature,  $V_{DD\pm} = \pm 5\text{ V}$ ;  $T_A = 25^\circ\text{C}$ , unless otherwise noted.

| PARAMETER  |  | TEST CONDITIONS   |                          | MIN  | TYP       | MAX   | UNIT                         |   |
|--|--|---|--------------------------|--|-----------|-------|------------------------------|---|
| $V_{IO}$   | Input offset voltage   | $V_{IC} = 0\text{ V}$ , $V_O = 0\text{ V}$ ,<br>$R_S = 50\ \Omega$                    | TLC2272                  | $T_A = 25^\circ\text{C}$                         | 300       | 2500  | $\mu\text{V}$                |   |
|  |  |   | TLC2272A                 |  | 300       | 950   |                              |   |
|  |  |   | TLC2272                  | Full Range <sup>(1)</sup>                        | 3000      |       |                              |   |
|  |  |   | TLC2272A                 |  | 1500      |       |                              |   |
| $\alpha_{VIO}$                                   | Temperature coefficient of input offset voltage                    | $V_{IC} = 0\text{ V}$ , $V_O = 0\text{ V}$ , $R_S = 50\ \Omega$                       |                          |  | 2         |       | $\mu\text{V}/^\circ\text{C}$ |   |
|  | Input offset voltage long-term drift <sup>(2)</sup>                | $V_{IC} = 0\text{ V}$ , $V_O = 0\text{ V}$ , $R_S = 50\ \Omega$                       |                          |  | 0.002     |       | $\mu\text{V}/\text{mo}$      |   |
| $I_{IO}$   | Input offset current   | $V_{IC} = 0\text{ V}$ , $V_O = 0\text{ V}$ ,<br>$R_S = 50\ \Omega$                    | All level parts          | $T_A = 25^\circ\text{C}$                         | 0.5       | 60    | $\text{pA}$                  |   |
|  |  |   | C level part             | $T_A = 0^\circ\text{C}$ to $80^\circ\text{C}$    | 100       |       |                              |   |
|  |  |   | I level part             | $T_A = -40^\circ\text{C}$ to $85^\circ\text{C}$  | 150       |       |                              |   |
|  |  |   | Q level part             | $T_A = -40^\circ\text{C}$ to $125^\circ\text{C}$ | 800       |       |                              |   |
|  |  |   | M level part             | $T_A = -55^\circ\text{C}$ to $125^\circ\text{C}$ | 800       |       |                              |   |
| $I_{IB}$   | Input bias current   | $V_{IC} = 0\text{ V}$ , $V_O = 0\text{ V}$ ,<br>$R_S = 50\ \Omega$                    | All level parts          | $T_A = 25^\circ\text{C}$                         | 1         | 60    | $\text{pA}$                  |   |
|  |  |   | C level part             | $T_A = 0^\circ\text{C}$ to $80^\circ\text{C}$    | 100       |       |                              |   |
|  |  |   | I level part             | $T_A = -40^\circ\text{C}$ to $85^\circ\text{C}$  | 150       |       |                              |   |
|  |  |   | Q level part             | $T_A = -40^\circ\text{C}$ to $125^\circ\text{C}$ | 800       |       |                              |   |
|  |  |   | M level part             | $T_A = -55^\circ\text{C}$ to $125^\circ\text{C}$ | 800       |       |                              |   |
| $V_{ICR}$  | Common-mode input voltage  | $R_S = 50\ \Omega$ ; $ V_{IO}  \leq 5\text{ mV}$                                      |                          | $T_A = 25^\circ\text{C}$                         | -5.3      | 0     | 4                            | V |
|  |  |   |                          | Full Range <sup>(1)</sup>                        | -5        | 0     | 3.5                          |   |
| $V_{OM+}$  | Maximum positive peak output voltage                               | $I_O = -20\ \mu\text{A}$  |                          | $T_A = 25^\circ\text{C}$                         | 4.85      | 4.93  | V                            |   |
|  |  |   |                          | Full Range <sup>(1)</sup>                        | 4.85      |       |                              |   |
|  |  |   |                          | $T_A = 25^\circ\text{C}$                         | 4.25      | 4.65  |                              |   |
|  |  |   |                          | Full Range <sup>(1)</sup>                        | 4.25      |       |                              |   |
| $V_{OM-}$  | Maximum negative peak output voltage                               | $V_{IC} = 0\text{ V}$ ,   | $I_O = 50\ \mu\text{A}$  |  | -4.99     |       | V                            |   |
|  |  |   | $I_O = 500\ \mu\text{A}$ | $T_A = 25^\circ\text{C}$                         | -4.85     | -4.91 |                              |   |
|  |  |   |                          | Full Range <sup>(1)</sup>                        | -4.85     |       |                              |   |
|  |  |   | $I_O = 5\text{ mA}$      | $T_A = 25^\circ\text{C}$                         | -3.5      | -4.1  |                              |   |
| Full Range <sup>(1)</sup>                        | -3.5   |   |                          |  |           |       |                              |   |
| $A_{VD}$   | Large-signal differential voltage amplification                    | $V_O = \pm 4\text{ V}$ ; $R_L = 10\text{ k}\Omega$                                    | C level part             | $T_A = 25^\circ\text{C}$                         | 25        | 50    | V/mV                         |   |
|  |  |   |                          | $T_A = 0^\circ\text{C}$ to $80^\circ\text{C}$    | 25        |       |                              |   |
|  |  |   | I level part             | $T_A = 25^\circ\text{C}$                         | 25        | 50    |                              |   |
|  |  |   |                          | $T_A = -40^\circ\text{C}$ to $85^\circ\text{C}$  | 25        |       |                              |   |
|  |  |   | Q level part             | $T_A = 25^\circ\text{C}$                         | 20        | 50    |                              |   |
|  |  |   |                          | $T_A = -40^\circ\text{C}$ to $125^\circ\text{C}$ | 20        |       |                              |   |
|  |  |   | M level part             | $T_A = 25^\circ\text{C}$                         | 20        | 50    |                              |   |
| $T_A = -55^\circ\text{C}$ to $125^\circ\text{C}$ | 20   |   |                          |  |           |       |                              |   |
|  |  | $V_O = \pm 4\text{ V}$ ; $R_L = 1\text{ M}\Omega$                                     |                          |  | 300       |       |                              |   |
| $r_{id}$   | Differential input resistance                                      |   |                          |  | $10^{12}$ |       | $\Omega$                     |   |
| $r_i$  | Common-mode input resistance                                       |   |                          |  | $10^{12}$ |       | $\Omega$                     |   |
| $c_i$  | Common-mode input capacitance                                      | $f = 10\text{ kHz}$ , P package   |                          |  | 8         |       | pF                           |   |
| $z_o$  | Closed-loop output impedance                                       | $f = 1\text{ MHz}$ , $A_V = 10$   |                          |  | 130       |       | $\Omega$                     |   |
| CMRR   | Common-mode rejection ratio  | $V_{IC} = -5\text{ V}$ to $2.7\text{ V}$ ,<br>$V_O = 0\text{ V}$ , $R_S = 50\ \Omega$ |                          | $T_A = 25^\circ\text{C}$                         | 75        | 80    | dB                           |   |
|  |  |   |                          | Full Range <sup>(1)</sup>                        | 75        |       |                              |   |
| $k_{SVR}$  | Supply-voltage rejection ratio ( $\Delta V_{DD} / \Delta V_{IO}$ ) | $V_{DD\pm} = 2.2\text{ V}$ to $\pm 8\text{ V}$ ,<br>$V_{IC} = 0\text{ V}$ , no load   |                          | $T_A = 25^\circ\text{C}$                         | 80        | 95    | dB                           |   |
|  |  |   |                          | Full Range <sup>(1)</sup>                        | 80        |       |                              |   |
| $I_{DD}$   | Supply current   | $V_O = 0\text{ V}$ , no load  |                          | $T_A = 25^\circ\text{C}$                         | 2.4       | 3     | mA                           |   |
|  |  |   |                          | Full Range <sup>(1)</sup>                        | 3         |       |                              |   |

(1)  $T_A = -55^\circ\text{C}$  to  $125^\circ\text{C}$ .

(2) Typical values are based on the input offset voltage shift observed through 168 hours of operating life test at  $T_A = 150^\circ\text{C}$  extrapolated to  $T_A = 25^\circ\text{C}$  using the Arrhenius equation and assuming an activation energy of 0.96 eV.



## TLC2272 and TLC2272A Electrical Characteristics $V_{DD\pm} = \pm 5\text{ V}$ (continued)

 at specified free-air temperature,  $V_{DD\pm} = \pm 5\text{ V}$ ;  $T_A = 25^\circ\text{C}$ , unless otherwise noted.

| PARAMETER |   | TEST CONDITIONS  |                                     | MIN | TYP     | MAX | UNIT                   |
|-----------|---|--|-------------------------------------|-----|---------|-----|------------------------|
| SR        | Slew rate at unity gain                     | $V_O = \pm 2.3\text{ V}$ ,<br>$R_L = 10\text{ k}\Omega$ , $C_L = 100\text{ pF}$                            | $T_A = 25^\circ\text{C}$            | 2.3 | 3.6     |     | V/ $\mu\text{s}$       |
|           |   |  | Full Range <sup>(1)</sup>           | 1.7 |         |     |                        |
| $V_n$     | Equivalent input noise voltage              |  | $f = 10\text{ Hz}$                  |     | 50      |     | nV/ $\sqrt{\text{Hz}}$ |
|           |   |  | $f = 1\text{ kHz}$                  |     | 9       |     |                        |
| $V_{NPP}$ | Peak-to-peak equivalent input noise voltage |  | $f = 0.1\text{ Hz to }1\text{ Hz}$  |     | 1       |     | $\mu\text{V}$          |
|           |   |  | $f = 0.1\text{ Hz to }10\text{ Hz}$ |     | 1.4     |     |                        |
| $I_n$     | Equivalent input noise current              |  |                                     |     | 0.6     |     | fA/ $\sqrt{\text{Hz}}$ |
| THD+N     | Total harmonic distortion + noise           | $V_O = \pm 2.3$ ,<br>$f = 20\text{ kHz}$ , $R_L = 10\text{ k}\Omega$                                       | $A_V = 1$                           |     | 0.0011% |     |                        |
|           |   |  | $A_V = 10$                          |     | 0.004%  |     |                        |
|           |   |  | $A_V = 100$                         |     | 0.03%   |     |                        |
|           | Gain-bandwidth product                      | $f = 10\text{ kHz}$ , $R_L = 10\text{ k}\Omega$ , $C_L = 100\text{ pF}$                                    |                                     |     | 2.25    |     | MHz                    |
| $B_{OM}$  | Maximum output-swing bandwidth              | $V_{O(PP)} = 4.6\text{ V}$ , $A_V = 1$ , $R_L = 10\text{ k}\Omega$ , $C_L = 100\text{ pF}$                 |                                     |     | 0.54    |     | MHz                    |
| $t_s$     | Settling time                               | $A_V = -1$ , $R_L = 10\text{ k}\Omega$ ,<br>Step = $-2.3\text{ V to }2.3\text{ V}$ , $C_L = 100\text{ pF}$ | $T_O = 0.1\%$                       |     | 1.5     |     | $\mu\text{s}$          |
|           |   |  | $T_O = 0.01\%$                      |     | 3.2     |     |                        |
| $\phi_m$  | Phase margin at unity gain                  | $R_L = 10\text{ k}\Omega$ , $C_L = 100\text{ pF}$  |                                     |     | 52°     |     |                        |
|           | Gain margin                                 | $R_L = 10\text{ k}\Omega$ , $C_L = 100\text{ pF}$  |                                     |     | 10      |     | dB                     |

## 6.7 TLC2274 and TLC2274A Electrical Characteristics $V_{DD} = 5\text{ V}$

 at specified free-air temperature,  $V_{DD} = 5\text{ V}$ ;  $T_A = 25^\circ\text{C}$ , unless otherwise noted.

| PARAMETER      |   | TEST CONDITIONS   |                           | MIN  | TYP   | MAX  | UNIT                         |               |  |
|----------------|---|---|---------------------------|--|-------|------|------------------------------|---------------|--|
| $V_{IO}$       | Input offset voltage                                | $V_{IC} = 0\text{ V}$ , $V_{DD\pm} = \pm 2.5\text{ V}$ ,<br>$V_O = 0\text{ V}$ , $R_S = 50\ \Omega$ | TLC2274                   | $T_A = 25^\circ\text{C}$                       |       | 300  | 2500                         | $\mu\text{V}$ |  |
|                |   |   | TLC2274A                  |  |       | 300  | 950                          |               |  |
|                |   |   | TLC2274                   | Full Range <sup>(1)</sup>                      |       |      | 3000                         |               |  |
|                |   |   | TLC2274A                  |  |       |      | 1500                         |               |  |
| $\alpha_{VIO}$ | Temperature coefficient of input offset voltage     | $V_{IC} = 0\text{ V}$ , $V_{DD\pm} = \pm 2.5\text{ V}$ , $V_O = 0\text{ V}$ , $R_S = 50\ \Omega$    |                           |  | 2     |      | $\mu\text{V}/^\circ\text{C}$ |               |  |
|                | Input offset voltage long-term drift <sup>(2)</sup> | $V_{IC} = 0\text{ V}$ , $V_{DD\pm} = \pm 2.5\text{ V}$ , $V_O = 0\text{ V}$ , $R_S = 50\ \Omega$    |                           |  | 0.002 |      | $\mu\text{V}/\text{mo}$      |               |  |
| $I_{IO}$       | Input offset current                                | $V_{IC} = 0\text{ V}$ , $V_{DD\pm} = \pm 2.5\text{ V}$ ,<br>$V_O = 0\text{ V}$ , $R_S = 50\ \Omega$ | All level parts           | $T_A = 25^\circ\text{C}$                       |       | 0.5  | 60                           | pA            |  |
|                |   |   | C level part              | $T_A = 0^\circ\text{C to }80^\circ\text{C}$    |       |      | 100                          |               |  |
|                |   |   | I level part              | $T_A = -40^\circ\text{C to }85^\circ\text{C}$  |       |      | 150                          |               |  |
|                |   |   | Q level part              | $T_A = -40^\circ\text{C to }125^\circ\text{C}$ |       |      | 800                          |               |  |
|                |   |   | M level part              | $T_A = -55^\circ\text{C to }125^\circ\text{C}$ |       |      | 800                          |               |  |
| $I_{IB}$       | Input bias current                                  | $V_{IC} = 0\text{ V}$ , $V_{DD\pm} = \pm 2.5\text{ V}$ ,<br>$V_O = 0\text{ V}$ , $R_S = 50\ \Omega$ | All level parts           | $T_A = 25^\circ\text{C}$                       |       | 1    | 60                           | pA            |  |
|                |   |   | C level part              | $T_A = 0^\circ\text{C to }80^\circ\text{C}$    |       |      | 100                          |               |  |
|                |   |   | I level part              | $T_A = -40^\circ\text{C to }85^\circ\text{C}$  |       |      | 150                          |               |  |
|                |   |   | Q level part              | $T_A = -40^\circ\text{C to }125^\circ\text{C}$ |       |      | 800                          |               |  |
|                |   |   | M level part              | $T_A = -55^\circ\text{C to }125^\circ\text{C}$ |       |      | 800                          |               |  |
| $V_{ICR}$      | Common-mode input voltage                           | $R_S = 50\ \Omega$ ; $ V_{IO}  \leq 5\text{ mV}$  | $T_A = 25^\circ\text{C}$  |  | -0.3  | 2.5  | 4                            | V             |  |
|                |   |   | Full Range <sup>(1)</sup> |  | 0     | 2.5  | 3.5                          |               |  |
| $V_{OH}$       | High-level output voltage                           | $I_{OH} = -20\ \mu\text{A}$   |                           |  |       | 4.99 | V                            |               |  |
|                |   |   | $T_A = 25^\circ\text{C}$  |  | 4.85  | 4.93 |                              |               |  |
|                |   |   | Full Range <sup>(1)</sup> |  | 4.85  |      |                              |               |  |
|                |   |   | $T_A = 25^\circ\text{C}$  |  | 4.25  | 4.65 |                              |               |  |
|                |   | $I_{OH} = -1\text{ mA}$   |                           |  |       | 4.25 |                              |               |  |

 (1)  $T_A = -55^\circ\text{C to }125^\circ\text{C}$ .

 (2) Typical values are based on the input offset voltage shift observed through 168 hours of operating life test at  $T_A = 150^\circ\text{C}$  extrapolated to  $T_A = 25^\circ\text{C}$  using the Arrhenius equation and assuming an activation energy of 0.96 eV.

## TLC2274 and TLC2274A Electrical Characteristics $V_{DD} = 5\text{ V}$ (continued)

at specified free-air temperature,  $V_{DD} = 5\text{ V}$ ;  $T_A = 25^\circ\text{C}$ , unless otherwise noted.

| PARAMETER                 |  | TEST CONDITIONS   |                             | MIN  | TYP     | MAX                    | UNIT |      |
|---------------------------|--|---|-----------------------------|--|---------|------------------------|------|------|
| $V_{OL}$                  | Low-level output voltage   | $V_{IC} = 2.5\text{ V}$   | $I_{OL} = 50\ \mu\text{A}$  |  | 0.01    |                        | V    |      |
|                           |  |   | $I_{OL} = 500\ \mu\text{A}$ | $T_A = 25^\circ\text{C}$                         |         | 0.09                   |      | 0.15 |
|                           |  |   |                             | Full Range <sup>(1)</sup>                        |         |                        |      | 0.15 |
|                           |  |   | $I_{OL} = 5\text{ mA}$      | $T_A = 25^\circ\text{C}$                         |         | 0.9                    |      | 1.5  |
| Full Range <sup>(1)</sup> |  |   |                             | 1.5  |         |                        |      |      |
| $A_{VD}$                  | Large-signal differential voltage amplification  | $V_{IC} = 2.5\text{ V}$ , $V_O = 1\text{ V}$ to $4\text{ V}$ ;<br>$R_L = 10\text{ k}\Omega$ <sup>(3)</sup>                                | C level part                | $T_A = 25^\circ\text{C}$                         | 15      | 35                     | V/mV |      |
|                           |  |   |                             | $T_A = 0^\circ\text{C}$ to $80^\circ\text{C}$    | 15      |                        |      |      |
|                           |  |   | I level part                | $T_A = 25^\circ\text{C}$                         | 15      | 35                     |      |      |
|                           |  |   |                             | $T_A = -40^\circ\text{C}$ to $85^\circ\text{C}$  | 15      |                        |      |      |
|                           |  |   | Q level part                | $T_A = 25^\circ\text{C}$                         | 10      | 35                     |      |      |
|                           |  |   |                             | $T_A = -40^\circ\text{C}$ to $125^\circ\text{C}$ | 10      |                        |      |      |
|                           |  |   | M level part                | $T_A = 25^\circ\text{C}$                         | 10      | 35                     |      |      |
|                           | $T_A = -55^\circ\text{C}$ to $125^\circ\text{C}$   | 10  |                             |  |         |                        |      |      |
|                           | $V_{IC} = 2.5\text{ V}$ , $V_O = 1\text{ V}$ to $4\text{ V}$ ; $R_L = 1\text{ M}\Omega$ <sup>(3)</sup> |   | 175                         |  |         |                        |      |      |
| $r_{id}$                  | Differential input resistance  |   |                             | $10^{12}$  |         | $\Omega$               |      |      |
| $r_i$                     | Common-mode input resistance   |   |                             | $10^{12}$  |         | $\Omega$               |      |      |
| $c_i$                     | Common-mode input capacitance  | $f = 10\text{ kHz}$ , P package   |                             |  | 8       | pF                     |      |      |
| $z_o$                     | Closed-loop output impedance   | $f = 1\text{ MHz}$ , $A_V = 10$   |                             |  | 140     | $\Omega$               |      |      |
| CMRR                      | Common-mode rejection ratio  | $V_{IC} = 0\text{ V}$ to $2.7\text{ V}$ ,<br>$V_O = 2.5\text{ V}$ , $R_S = 50\ \Omega$  | $T_A = 25^\circ\text{C}$    | 70   | 75      | dB                     |      |      |
|                           |  |   | Full Range <sup>(1)</sup>   | 70   |         |                        |      |      |
| $k_{SVR}$                 | Supply-voltage rejection ratio ( $\Delta V_{DD} / \Delta V_{IO}$ )                                     | $V_{DD} = 4.4\text{ V}$ to $16\text{ V}$ ,<br>$V_{IC} = V_{DD} / 2$ , no load   | $T_A = 25^\circ\text{C}$    | 80   | 95      | dB                     |      |      |
|                           |  |   | Full Range <sup>(1)</sup>   | 80   |         |                        |      |      |
| $I_{DD}$                  | Supply current   | $V_O = 2.5\text{ V}$ , no load  | $T_A = 25^\circ\text{C}$    |  | 4.4     | 6                      | mA   |      |
|                           |  |   | Full Range <sup>(1)</sup>   |  |         | 6                      |      |      |
| SR                        | Slew rate at unity gain  | $V_O = 0.5\text{ V}$ to $2.5\text{ V}$ ,<br>$R_L = 10\text{ k}\Omega$ <sup>(3)</sup> , $C_L = 100\text{ pF}$ <sup>(3)</sup>               | $T_A = 25^\circ\text{C}$    | 2.3  | 3.6     | V/ $\mu\text{s}$       |      |      |
|                           |  |   | Full Range <sup>(1)</sup>   | 1.7  |         |                        |      |      |
| $V_n$                     | Equivalent input noise voltage   | $f = 10\text{ Hz}$  |                             |  | 50      | nV/ $\sqrt{\text{Hz}}$ |      |      |
|                           |  | $f = 1\text{ kHz}$  |                             |  | 9       |                        |      |      |
| $V_{NPP}$                 | Peak-to-peak equivalent input noise voltage  | $f = 0.1\text{ Hz}$ to $1\text{ Hz}$  |                             |  | 1       | $\mu\text{V}$          |      |      |
|                           |  | $f = 0.1\text{ Hz}$ to $10\text{ Hz}$   |                             |  | 1.4     |                        |      |      |
| $I_n$                     | Equivalent input noise current   |   |                             |  | 0.6     | fA/ $\sqrt{\text{Hz}}$ |      |      |
| THD+N                     | Total harmonic distortion + noise  | $V_O = 0.5\text{ V}$ to $2.5\text{ V}$ ,<br>$f = 20\text{ kHz}$ , $R_L = 10\text{ k}\Omega$ <sup>(3)</sup>                                | $A_V = 1$                   |  | 0.0013% |                        |      |      |
|                           |  |   | $A_V = 10$                  |  | 0.004%  |                        |      |      |
|                           |  |   | $A_V = 100$                 |  | 0.03%   |                        |      |      |
|                           | Gain-bandwidth product   | $f = 10\text{ kHz}$ , $R_L = 10\text{ k}\Omega$ <sup>(3)</sup> , $C_L = 100\text{ pF}$ <sup>(3)</sup>                                     |                             |  | 2.18    | MHz                    |      |      |
| $B_{OM}$                  | Maximum output-swing bandwidth   | $V_{O(PP)} = 2\text{ V}$ , $A_V = 1$ , $R_L = 10\text{ k}\Omega$ <sup>(3)</sup> , $C_L = 100\text{ pF}$ <sup>(3)</sup>                    |                             |  | 1       | MHz                    |      |      |
| $t_s$                     | Settling time  | $A_V = -1$ , $R_L = 10\text{ k}\Omega$ <sup>(3)</sup> ,<br>Step = $0.5\text{ V}$ to $2.5\text{ V}$ , $C_L = 100\text{ pF}$ <sup>(3)</sup> | $T_O = 0.1\%$               |  | 1.5     | $\mu\text{s}$          |      |      |
|                           |  |   | $T_O = 0.01\%$              |  | 2.6     |                        |      |      |
| $\Phi_m$                  | Phase margin at unity gain   | $R_L = 10\text{ k}\Omega$ <sup>(3)</sup> , $C_L = 100\text{ pF}$ <sup>(3)</sup>   |                             |  | 50°     |                        |      |      |
|                           | Gain margin  | $R_L = 10\text{ k}\Omega$ <sup>(3)</sup> , $C_L = 100\text{ pF}$ <sup>(3)</sup>   |                             |  | 10      | dB                     |      |      |

(3) Referenced to 0 V.

## 6.8 TLC2274 and TLC2274A Electrical Characteristics $V_{DD\pm} = \pm 5\text{ V}$

at specified free-air temperature,  $V_{DD\pm} = \pm 5\text{ V}$ ;  $T_A = 25^\circ\text{C}$ , unless otherwise noted.

| PARAMETER  |  | TEST CONDITIONS   |                          | MIN  | TYP       | MAX   | UNIT                         |   |
|--|--|---|--------------------------|--|-----------|-------|------------------------------|---|
| $V_{IO}$   | Input offset voltage   | $V_{IC} = 0\text{ V}$ , $V_O = 0\text{ V}$ ,<br>$R_S = 50\ \Omega$                    | TLC2274                  | $T_A = 25^\circ\text{C}$                         | 300       | 2500  | $\mu\text{V}$                |   |
|  |  |   | TLC2274A                 |  | 300       | 950   |                              |   |
|  |  |   | TLC2274                  | Full Range <sup>(1)</sup>                        | 3000      |       |                              |   |
|  |  |   | TLC2274A                 |  | 1500      |       |                              |   |
| $\alpha_{VIO}$                                   | Temperature coefficient of input offset voltage                    | $V_{IC} = 0\text{ V}$ , $V_O = 0\text{ V}$ , $R_S = 50\ \Omega$                       |                          |  | 2         |       | $\mu\text{V}/^\circ\text{C}$ |   |
|  | Input offset voltage long-term drift <sup>(2)</sup>                | $V_{IC} = 0\text{ V}$ , $V_O = 0\text{ V}$ , $R_S = 50\ \Omega$                       |                          |  | 0.002     |       | $\mu\text{V}/\text{mo}$      |   |
| $I_{IO}$   | Input offset current   | $V_{IC} = 0\text{ V}$ , $V_O = 0\text{ V}$ ,<br>$R_S = 50\ \Omega$                    | All level parts          | $T_A = 25^\circ\text{C}$                         | 0.5       | 60    | $\text{pA}$                  |   |
|  |  |   | C level part             | $T_A = 0^\circ\text{C}$ to $80^\circ\text{C}$    | 100       |       |                              |   |
|  |  |   | I level part             | $T_A = -40^\circ\text{C}$ to $85^\circ\text{C}$  | 150       |       |                              |   |
|  |  |   | Q level part             | $T_A = -40^\circ\text{C}$ to $125^\circ\text{C}$ | 800       |       |                              |   |
|  |  |   | M level part             | $T_A = -55^\circ\text{C}$ to $125^\circ\text{C}$ | 800       |       |                              |   |
| $I_{IB}$   | Input bias current   | $V_{IC} = 0\text{ V}$ , $V_O = 0\text{ V}$ ,<br>$R_S = 50\ \Omega$                    | All level parts          | $T_A = 25^\circ\text{C}$                         | 1         | 60    | $\text{pA}$                  |   |
|  |  |   | C level part             | $T_A = 0^\circ\text{C}$ to $80^\circ\text{C}$    | 100       |       |                              |   |
|  |  |   | I level part             | $T_A = -40^\circ\text{C}$ to $85^\circ\text{C}$  | 150       |       |                              |   |
|  |  |   | Q level part             | $T_A = -40^\circ\text{C}$ to $125^\circ\text{C}$ | 800       |       |                              |   |
|  |  |   | M level part             | $T_A = -55^\circ\text{C}$ to $125^\circ\text{C}$ | 800       |       |                              |   |
| $V_{ICR}$  | Common-mode input voltage  | $R_S = 50\ \Omega$ ; $ V_{IO}  \leq 5\text{ mV}$                                      |                          | $T_A = 25^\circ\text{C}$                         | -5.3      | 0     | 4                            | V |
|  |  |   |                          | Full Range <sup>(1)</sup>                        | -5        | 0     | 3.5                          |   |
| $V_{OM+}$  | Maximum positive peak output voltage                               | $I_O = -20\ \mu\text{A}$  |                          | $T_A = 25^\circ\text{C}$                         | 4.85      | 4.93  | V                            |   |
|  |  |   |                          | Full Range <sup>(1)</sup>                        | 4.85      |       |                              |   |
|  |  |   |                          | $T_A = 25^\circ\text{C}$                         | 4.25      | 4.65  |                              |   |
|  |  |   |                          | Full Range <sup>(1)</sup>                        | 4.25      |       |                              |   |
| $V_{OM-}$  | Maximum negative peak output voltage                               | $V_{IC} = 0\text{ V}$   | $I_O = 50\ \mu\text{A}$  |  | -4.99     |       | V                            |   |
|  |  |   | $I_O = 500\ \mu\text{A}$ | $T_A = 25^\circ\text{C}$                         | -4.85     | -4.91 |                              |   |
|  |  |   |                          | Full Range <sup>(1)</sup>                        | -4.85     |       |                              |   |
|  |  |   | $I_O = 5\text{ mA}$      | $T_A = 25^\circ\text{C}$                         | -3.5      | -4.1  |                              |   |
| Full Range <sup>(1)</sup>                        | -3.5   |   |                          |  |           |       |                              |   |
| $A_{VD}$   | Large-signal differential voltage amplification                    | $V_O = \pm 4\text{ V}$ ; $R_L = 10\text{ k}\Omega$                                    | C level part             | $T_A = 25^\circ\text{C}$                         | 25        | 50    | V/mV                         |   |
|  |  |   |                          | $T_A = 0^\circ\text{C}$ to $80^\circ\text{C}$    | 25        |       |                              |   |
|  |  |   | I level part             | $T_A = 25^\circ\text{C}$                         | 25        | 50    |                              |   |
|  |  |   |                          | $T_A = -40^\circ\text{C}$ to $85^\circ\text{C}$  | 25        |       |                              |   |
|  |  |   | Q level part             | $T_A = 25^\circ\text{C}$                         | 20        | 50    |                              |   |
|  |  |   |                          | $T_A = -40^\circ\text{C}$ to $125^\circ\text{C}$ | 20        |       |                              |   |
|  |  |   | M level part             | $T_A = 25^\circ\text{C}$                         | 20        | 50    |                              |   |
| $T_A = -55^\circ\text{C}$ to $125^\circ\text{C}$ | 20   |   |                          |  |           |       |                              |   |
|  |  | $V_O = \pm 4\text{ V}$ ; $R_L = 1\text{ M}\Omega$                                     |                          |  | 300       |       |                              |   |
| $r_{id}$   | Differential input resistance                                      |   |                          |  | $10^{12}$ |       | $\Omega$                     |   |
| $r_i$  | Common-mode input resistance                                       |   |                          |  | $10^{12}$ |       | $\Omega$                     |   |
| $c_i$  | Common-mode input capacitance                                      | $f = 10\text{ kHz}$ , P package   |                          |  | 8         |       | pF                           |   |
| $z_o$  | Closed-loop output impedance                                       | $f = 1\text{ MHz}$ , $A_V = 10$   |                          |  | 130       |       | $\Omega$                     |   |
| CMRR   | Common-mode rejection ratio  | $V_{IC} = -5\text{ V}$ to $2.7\text{ V}$ ,<br>$V_O = 0\text{ V}$ , $R_S = 50\ \Omega$ |                          | $T_A = 25^\circ\text{C}$                         | 75        | 80    | dB                           |   |
|  |  |   |                          | Full Range <sup>(1)</sup>                        | 75        |       |                              |   |
| $k_{SVR}$  | Supply-voltage rejection ratio ( $\Delta V_{DD} / \Delta V_{IO}$ ) | $V_{DD\pm} = 2.2\text{ V}$ to $\pm 8\text{ V}$ ,<br>$V_{IC} = 0\text{ V}$ , no load   |                          | $T_A = 25^\circ\text{C}$                         | 80        | 95    | dB                           |   |
|  |  |   |                          | Full Range <sup>(1)</sup>                        | 80        |       |                              |   |
| $I_{DD}$   | Supply current   | $V_O = 0\text{ V}$ , no load  |                          | $T_A = 25^\circ\text{C}$                         | 4.8       | 6     | mA                           |   |
|  |  |   |                          | Full Range <sup>(1)</sup>                        | 6         |       |                              |   |

(1)  $T_A = -55^\circ\text{C}$  to  $125^\circ\text{C}$ .

(2) Typical values are based on the input offset voltage shift observed through 168 hours of operating life test at  $T_A = 150^\circ\text{C}$  extrapolated to  $T_A = 25^\circ\text{C}$  using the Arrhenius equation and assuming an activation energy of 0.96 eV.

### TLC2274 and TLC2274A Electrical Characteristics $V_{DD\pm} = \pm 5 \text{ V}$ (continued)

at specified free-air temperature,  $V_{DD\pm} = \pm 5 \text{ V}$ ;  $T_A = 25^\circ\text{C}$ , unless otherwise noted.

| PARAMETER |   | TEST CONDITIONS   |  | MIN | TYP     | MAX | UNIT                   |
|-----------|---|---|--|-----|---------|-----|------------------------|
| SR        | Slew rate at unity gain                     | $V_O = \pm 2.3 \text{ V}$ ,<br>$R_L = 10 \text{ k}\Omega$ , $C_L = 100 \text{ pF}$                              | $T_A = 25^\circ\text{C}$               | 2.3 | 3.6     |     | V/ $\mu\text{s}$       |
|           |   |   | Full Range <sup>(1)</sup>              | 1.7 |         |     |                        |
| $V_n$     | Equivalent input noise voltage              |   | $f = 10 \text{ Hz}$                    |     | 50      |     | nV/ $\sqrt{\text{Hz}}$ |
|           |   |   | $f = 1 \text{ kHz}$                    |     | 9       |     |                        |
| $V_{NPP}$ | Peak-to-peak equivalent input noise voltage |   | $f = 0.1 \text{ Hz to } 1 \text{ Hz}$  |     | 1       |     | $\mu\text{V}$          |
|           |   |   | $f = 0.1 \text{ Hz to } 10 \text{ Hz}$ |     | 1.4     |     |                        |
| $I_n$     | Equivalent input noise current              |   |  |     | 0.6     |     | fA/ $\sqrt{\text{Hz}}$ |
| THD+N     | Total harmonic distortion + noise           | $V_O = \pm 2.3$ ,<br>$f = 20 \text{ kHz}$ , $R_L = 10 \text{ k}\Omega$  | $A_V = 1$                              |     | 0.0011% |     |                        |
|           |   |   | $A_V = 10$                             |     | 0.004%  |     |                        |
|           |   |   | $A_V = 100$                            |     | 0.03%   |     |                        |
|           | Gain-bandwidth product                      | $f = 10 \text{ kHz}$ , $R_L = 10 \text{ k}\Omega$ , $C_L = 100 \text{ pF}$                                      |  |     | 2.25    |     | MHz                    |
| $B_{OM}$  | Maximum output-swing bandwidth              | $V_{O(PP)} = 4.6 \text{ V}$ , $A_V = 1$ , $R_L = 10 \text{ k}\Omega$ , $C_L = 100 \text{ pF}$                   |  |     | 0.54    |     | MHz                    |
| $t_s$     | Settling time                               | $A_V = -1$ , $R_L = 10 \text{ k}\Omega$ ,<br>Step = $-2.3 \text{ V to } 2.3 \text{ V}$ , $C_L = 100 \text{ pF}$ | $T_o 0.1\%$                            |     | 1.5     |     | $\mu\text{s}$          |
|           |   |   | $T_o 0.01\%$                           |     | 3.2     |     |                        |
| $\Phi_m$  | Phase margin at unity gain                  | $R_L = 10 \text{ k}\Omega$ , $C_L = 100 \text{ pF}$   |  |     | 52°     |     |                        |
|           | Gain margin                                 | $R_L = 10 \text{ k}\Omega$ , $C_L = 100 \text{ pF}$   |  |     | 10      |     | dB                     |

## 6.9 Typical Characteristics

**Table 1. Table of Graphs**

|                   |  |                               | <b>FIGURE<sup>(1)</sup></b>                        |
|-------------------|--|-------------------------------|--|
| $V_{IO}$          | Input offset voltage   | Distribution                  | <a href="#">1, 2, 3, 4</a>                         |
|                   |  | vs Common-mode voltage        | <a href="#">5, 6</a>                               |
| $\alpha_{VIO}$    | Input offset voltage temperature coefficient                     | Distribution                  | <a href="#">7, 8, 9, 10<sup>(2)</sup></a>          |
| $I_{IB} / I_{IO}$ | Input bias and input offset current                              | vs Free-air temperature       | <a href="#">11<sup>(2)</sup></a>                   |
| $V_I$             | Input voltage  | vs Supply voltage             | <a href="#">12</a>                                 |
|                   |  | vs Free-air temperature       | <a href="#">13<sup>(2)</sup></a>                   |
| $V_{OH}$          | High-level output voltage  | vs High-level output current  | <a href="#">14<sup>(2)</sup></a>                   |
| $V_{OL}$          | Low-level output voltage   | vs Low-level output current   | <a href="#">15, 16<sup>(2)</sup></a>               |
| $V_{OM+}$         | Maximum positive peak output voltage                             | vs Output current             | <a href="#">17<sup>(2)</sup></a>                   |
| $V_{OM-}$         | Maximum negative peak output voltage                             | vs Output current             | <a href="#">18<sup>(2)</sup></a>                   |
| $V_{O(PP)}$       | Maximum peak-to-peak output voltage                              | vs Frequency                  | <a href="#">19</a>                                 |
| $I_{OS}$          | Short-circuit output current                                     | vs Supply voltage             | <a href="#">20</a>                                 |
|                   |  | vs Free-air temperature       | <a href="#">21<sup>(2)</sup></a>                   |
| $V_O$             | Output voltage   | vs Differential input voltage | <a href="#">22, 23</a>                             |
| $A_{VD}$          | Large-signal differential voltage amplification                  | vs Load resistance            | <a href="#">24</a>                                 |
|                   | Large-signal differential voltage amplification and phase margin | vs Frequency                  | <a href="#">25, 26</a>                             |
|                   | Large-signal differential voltage amplification                  | vs Free-air temperature       | <a href="#">27<sup>(2)</sup>, 28<sup>(2)</sup></a> |
| $z_0$             | Output impedance   | vs Frequency                  | <a href="#">29, 30</a>                             |
| CMRR              | Common-mode rejection ratio                                      | vs Frequency                  | <a href="#">31</a>                                 |
|                   |  | vs Free-air temperature       | <a href="#">32</a>                                 |
| $k_{SVR}$         | Supply-voltage rejection ratio                                   | vs Frequency                  | <a href="#">33, 34</a>                             |
|                   |  | vs Free-air temperature       | <a href="#">35<sup>(2)</sup></a>                   |
| $I_{DD}$          | Supply current   | vs Supply voltage             | <a href="#">36<sup>(2)</sup>, 37<sup>(2)</sup></a> |
|                   |  | vs Free-air temperature       | <a href="#">38<sup>(2)</sup>, 39<sup>(2)</sup></a> |
| SR                | Slew rate  | vs Load Capacitance           | <a href="#">40</a>                                 |
|                   |  | vs Free-air temperature       | <a href="#">41<sup>(2)</sup></a>                   |
| $V_O$             | Inverting large-signal pulse response                            |                               | <a href="#">42, 43</a>                             |
|                   | Voltage-follower large-signal pulse response                     |                               | <a href="#">44, 45</a>                             |
|                   | Inverting small-signal pulse response                            |                               | <a href="#">46, 47</a>                             |
|                   | Voltage-follower small-signal pulse response                     |                               | <a href="#">48, 49</a>                             |
| $V_n$             | Equivalent input noise voltage                                   | vs Frequency                  | <a href="#">50, 51</a>                             |
|                   | Noise voltage over a 10-second period                            |                               | <a href="#">52</a>                                 |
|                   | Integrated noise voltage   | vs Frequency                  | <a href="#">53</a>                                 |
| THD+N             | Total harmonic distortion + noise                                | vs Frequency                  | <a href="#">54</a>                                 |
|                   |  | Gain-bandwidth product        | vs Supply voltage                                  |
|                   |  | vs Free-air temperature       | <a href="#">56<sup>(2)</sup></a>                   |
| $\Phi_m$          | Phase margin   | vs Load capacitance           | <a href="#">57</a>                                 |
|                   | Gain margin  | vs Load capacitance           | <a href="#">58</a>                                 |

(1) For all graphs where  $V_{DD} = 5\text{ V}$ , all loads are referenced to 2.5 V.

(2) Data at high and low temperatures are applicable only within the rated operating free-air temperature ranges of the various devices.

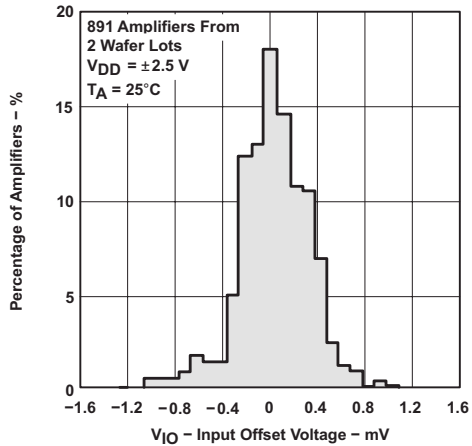

Figure 1. Distribution of TLC2272 Input Offset Voltage

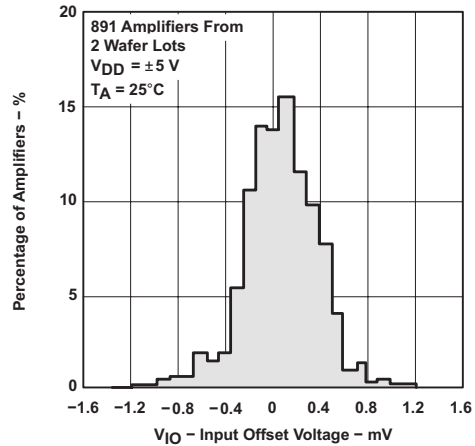

Figure 2. Distribution of TLC2272 Input Offset Voltage

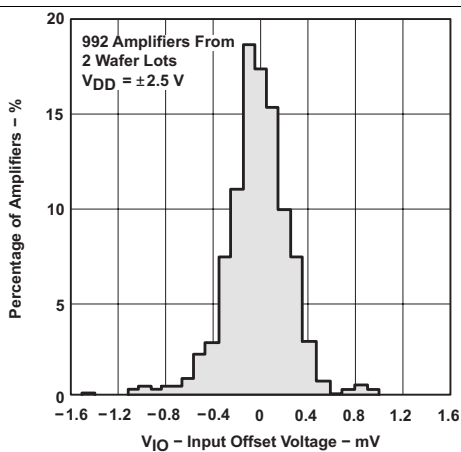

Figure 3. Distribution of TLC2274 Input Offset Voltage

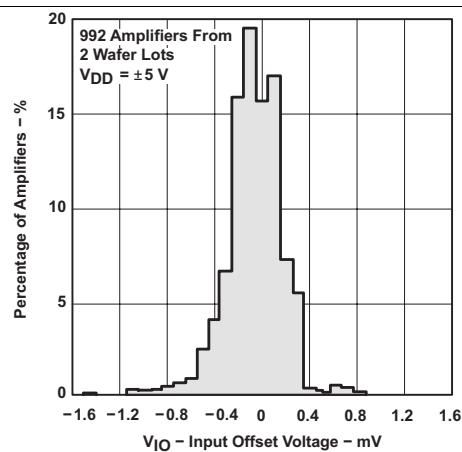

Figure 4. Distribution of TLC2274 Input Offset Voltage

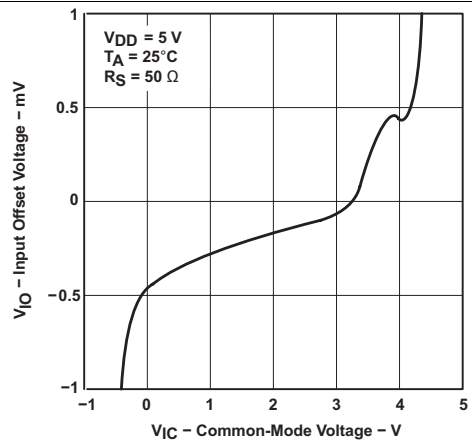

Figure 5. Input Offset Voltage vs Common-Mode Voltage

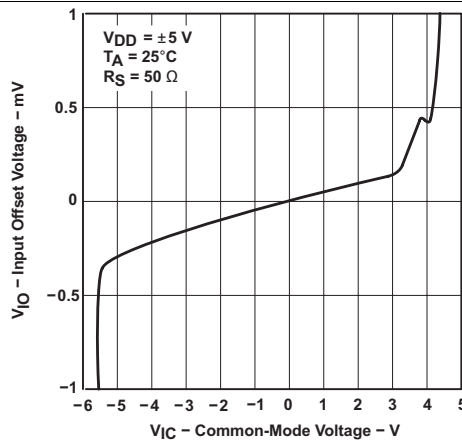

Figure 6. Input Offset Voltage vs Common-Mode Voltage

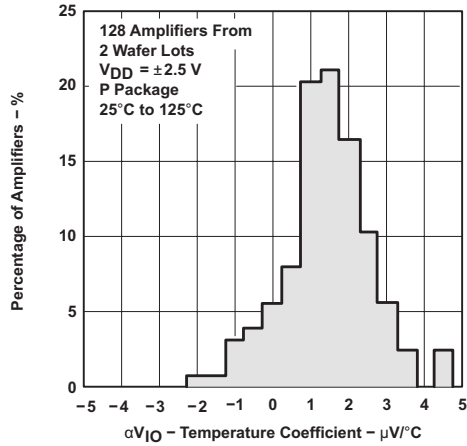

Figure 7. Distribution of TLC2272 vs Input Offset Voltage Temperature Coefficient

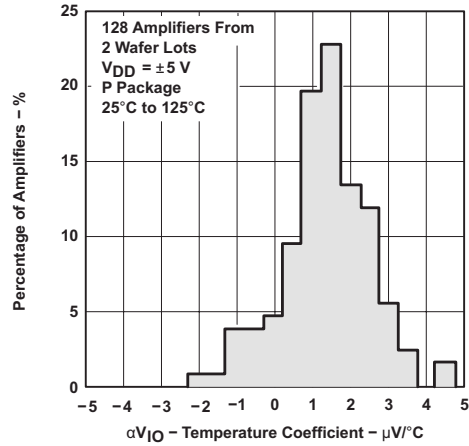

Figure 8. Distribution of TLC2272 vs Input Offset Voltage Temperature Coefficient

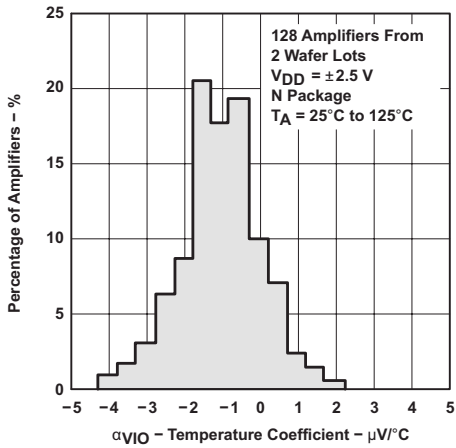

Figure 9. Distribution of TLC2274 vs Input Offset Voltage Temperature Coefficient

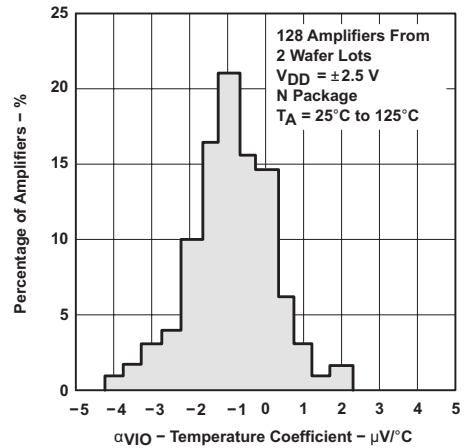

Figure 10. Distribution of TLC2274 vs Input Offset Voltage Temperature Coefficient

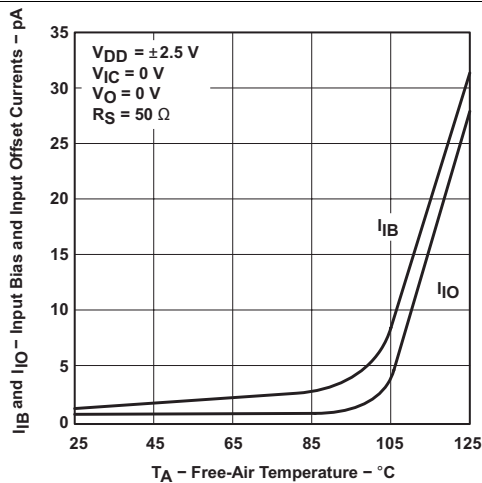

Figure 11. Input Bias and Input Offset Current vs Free-Air Temperature

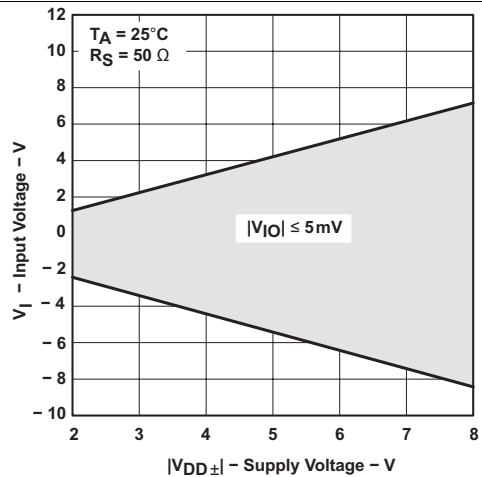

Figure 12. Input Voltage vs Supply Voltage

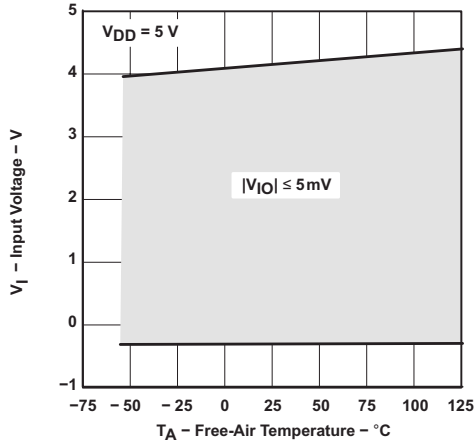

Figure 13. Input Voltage vs Free-Air Temperature

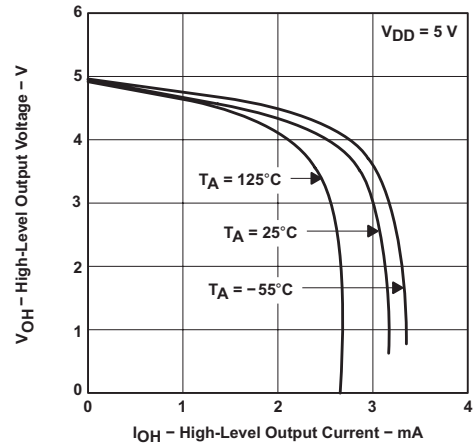

Figure 14. High-Level Output Voltage vs High-Level Output Current

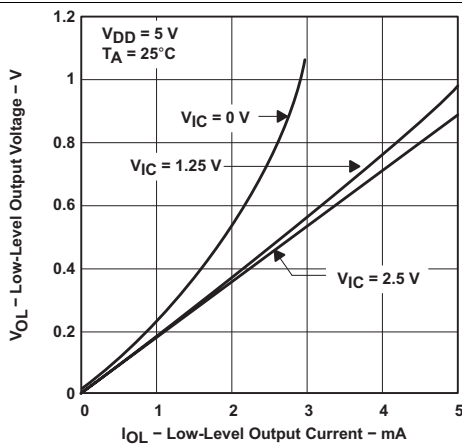

Figure 15. Low-Level Output Voltage vs Low-Level Output Current

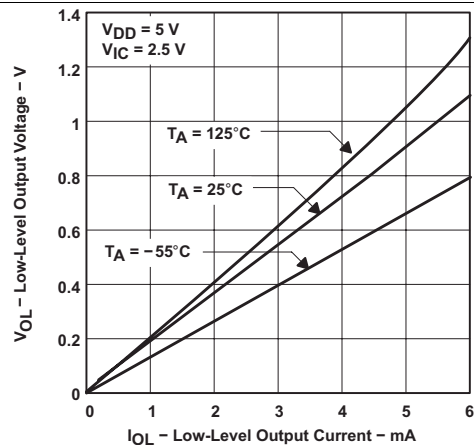

Figure 16. Low-Level Output Voltage vs Low-Level Output Current

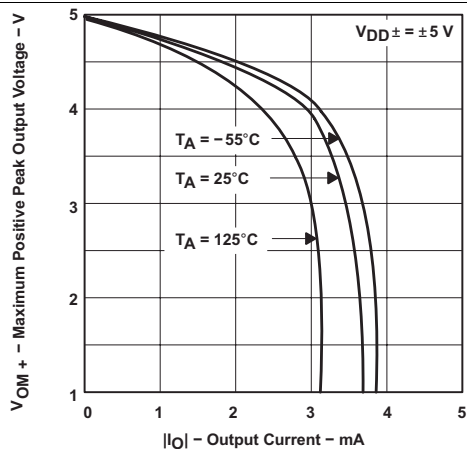

Figure 17. Maximum Positive Peak Output Voltage vs Output Current

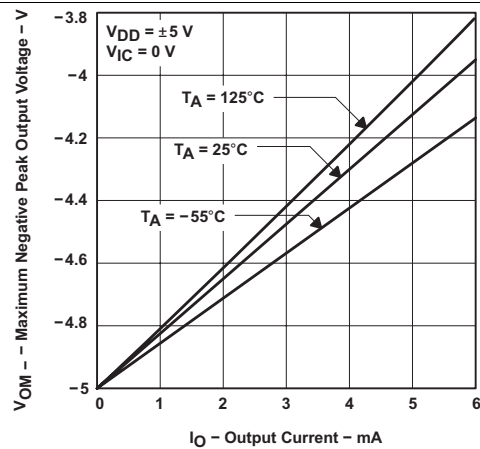

Figure 18. Maximum Positive Peak Output Voltage vs Output Current



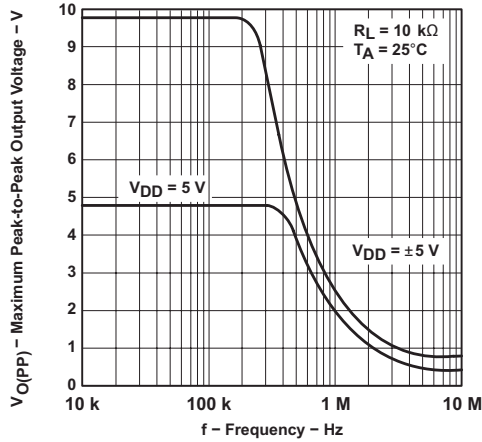

Figure 19. Maximum Peak-to-Peak Output Voltage vs Frequency

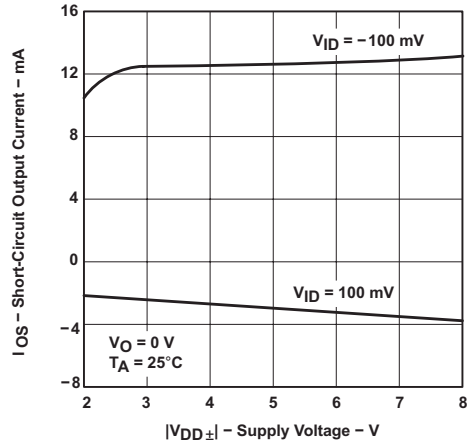

Figure 20. Short-Circuit Output Current vs Supply Voltage

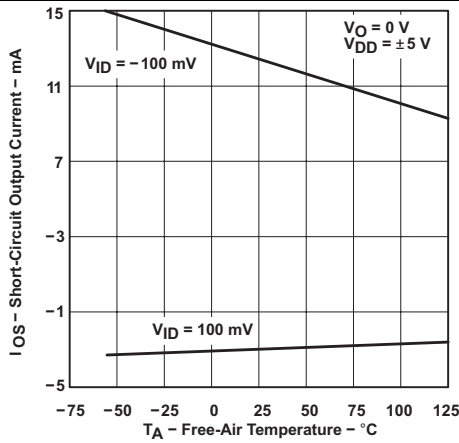

Figure 21. Short-Circuit Output Current vs Free-Air Temperature

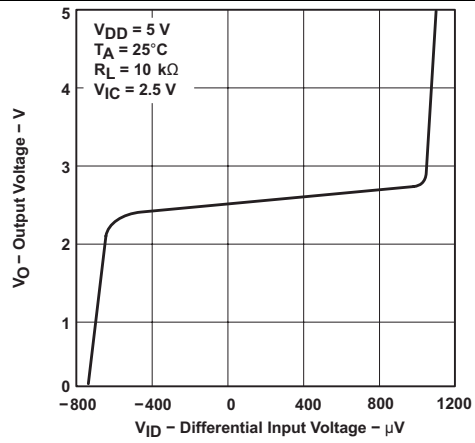

Figure 22. Output Voltage vs Differential Input Voltage

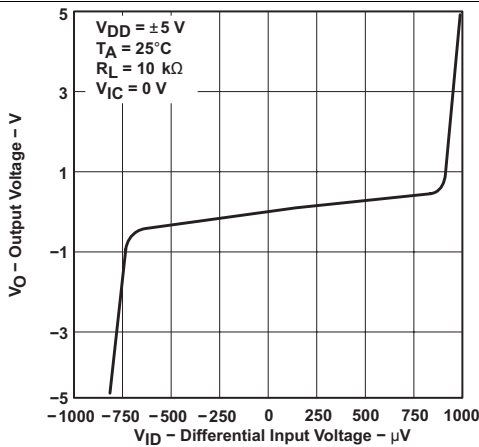

Figure 23. Output Voltage vs Differential Input Voltage

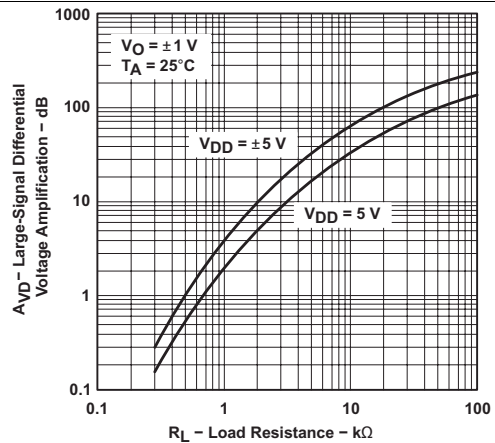

Figure 24. Large-Signal Differential Voltage Amplification vs Load Resistance

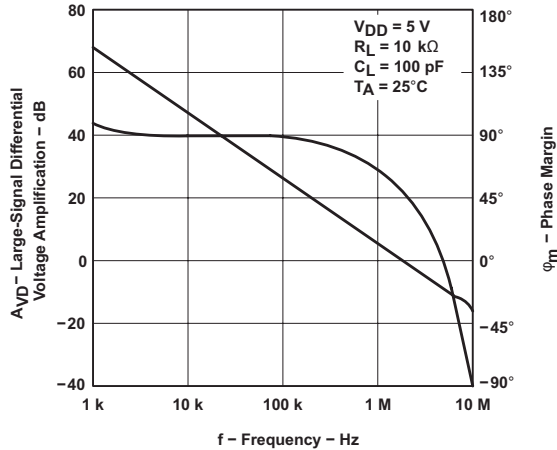

Figure 25. Large-Signal Differential Voltage Amplification and Phase Margin vs Frequency

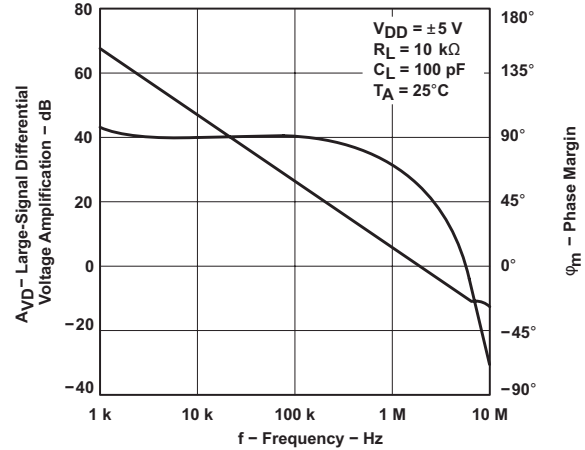

Figure 26. Large-Signal Differential Voltage Amplification and Phase Margin vs Frequency

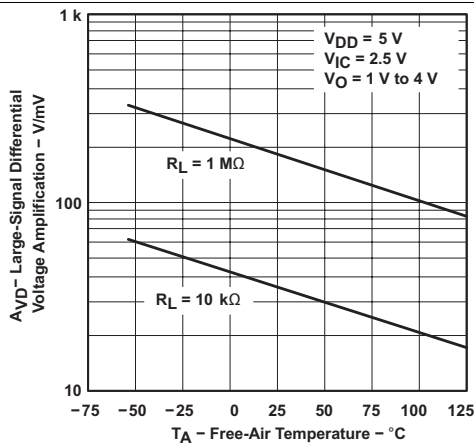

Figure 27. Large-Signal Differential Voltage Amplification vs Free-Air Temperature

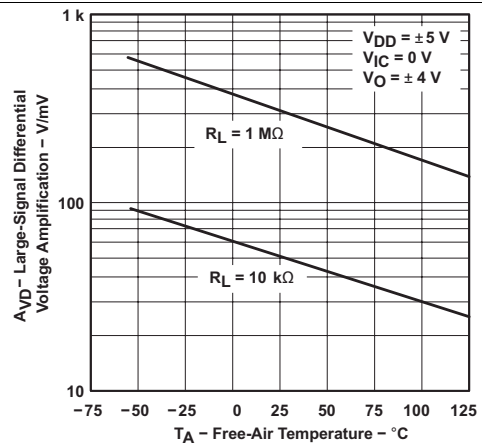

Figure 28. Large-Signal Differential Voltage Amplification vs Free-Air Temperature

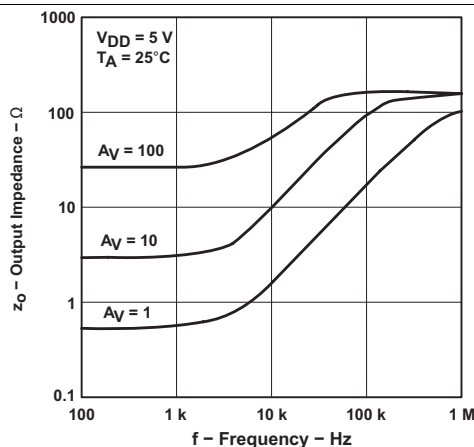

Figure 29. Output Impedance vs Frequency

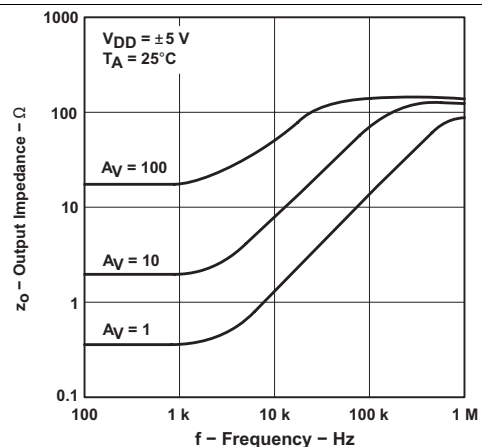

Figure 30. Output Impedance vs Frequency

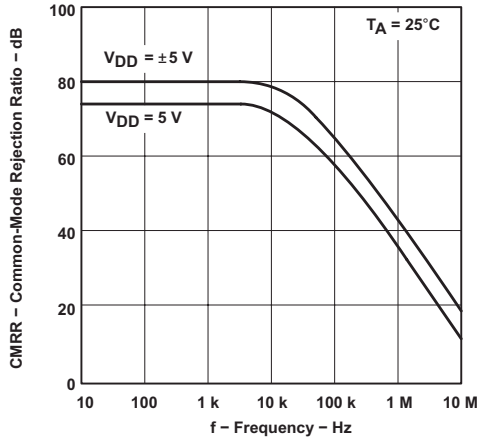

Figure 31. Common-Mode Rejection Ratio vs Frequency

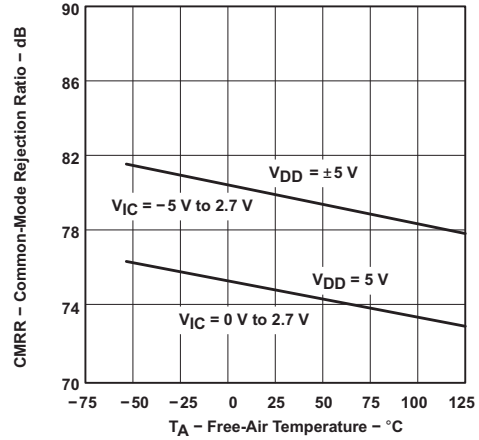

Figure 32. Common-Mode Rejection Ratio vs Free-Air Temperature

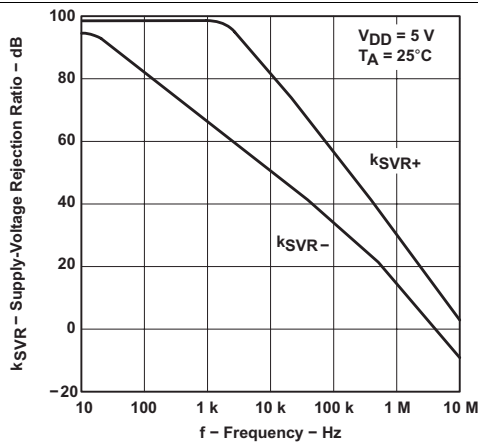

Figure 33. Supply-Voltage Rejection Ratio vs Frequency

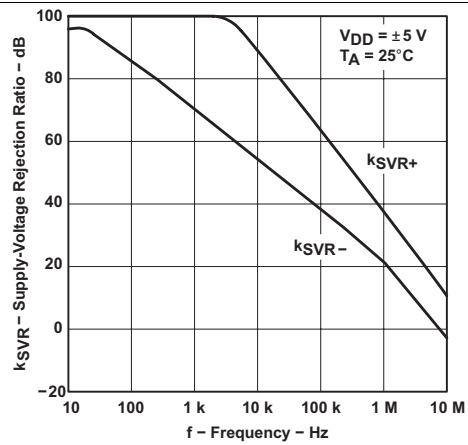

Figure 34. Supply-Voltage Rejection Ratio vs Frequency

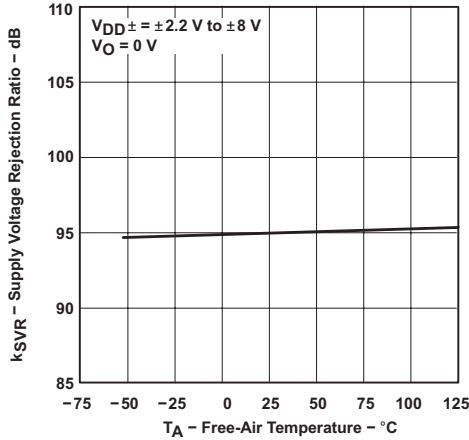

Figure 35. Supply-Voltage Rejection Ratio vs Free-Air Temperature

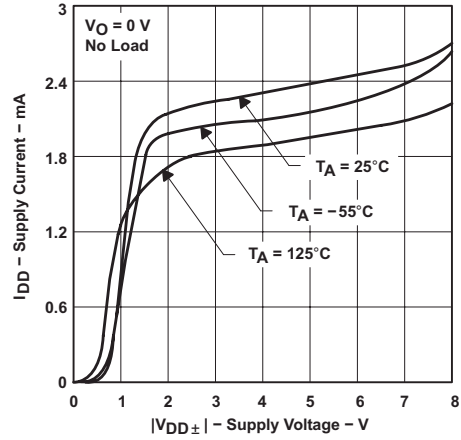

Figure 36. TLC2272 Supply Current vs Supply Voltage

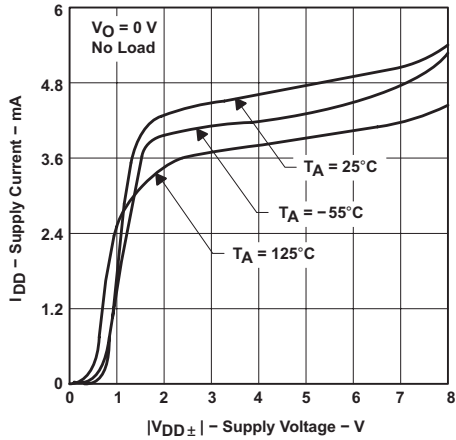

Figure 37. TLC2274 Supply Current vs Supply Voltage

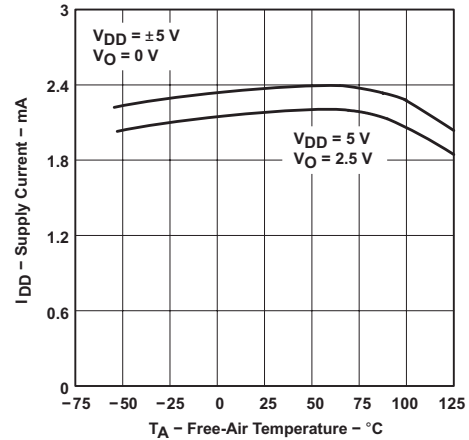

Figure 38. TLC2272 Supply Current vs Free-Air Temperature

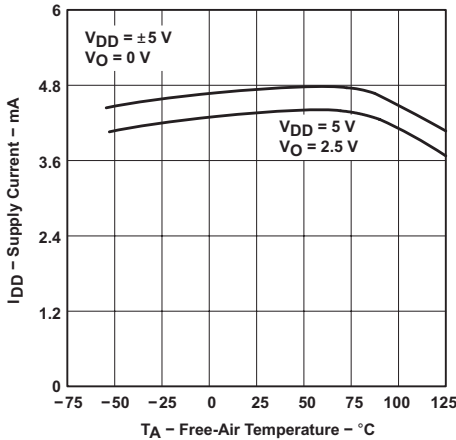

Figure 39. TLC2274 Supply Current vs Free-Air Temperature

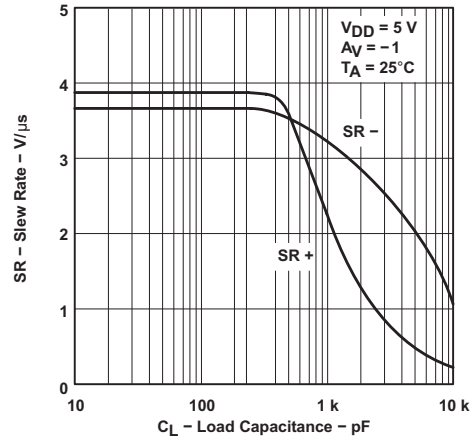

Figure 40. Slew Rate vs Load Capacitance

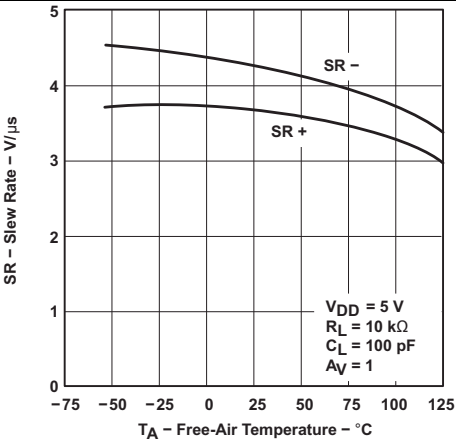

Figure 41. Slew Rate vs Free-Air Temperature

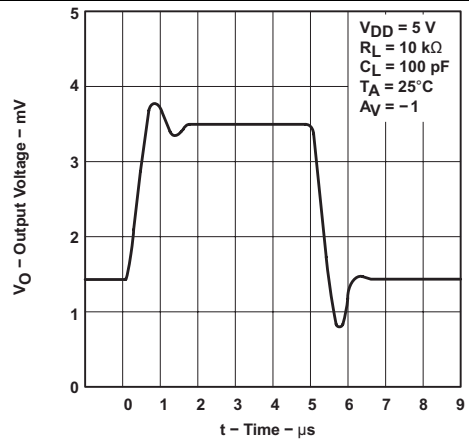

Figure 42. Inverting Large-Signal Pulse Response

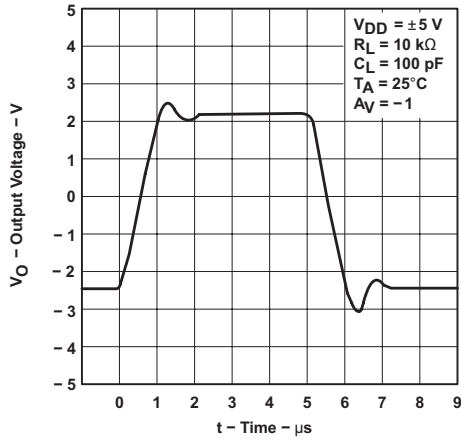

Figure 43. Inverting Large-Signal Pulse Response

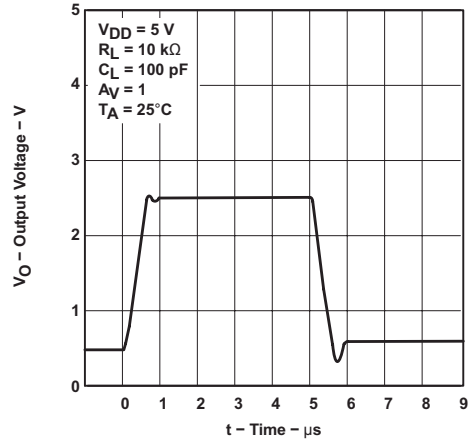

Figure 44. Voltage-Follower Large-Signal Pulse Response

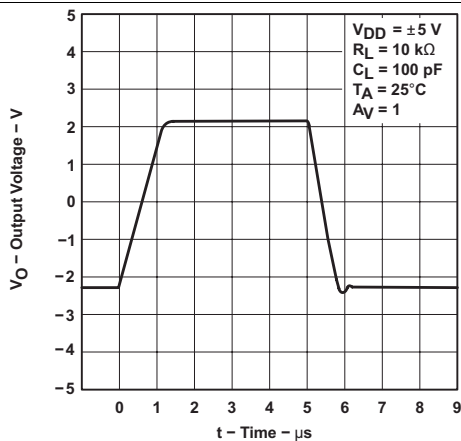

Figure 45. Voltage-Follower Large-Signal Pulse Response

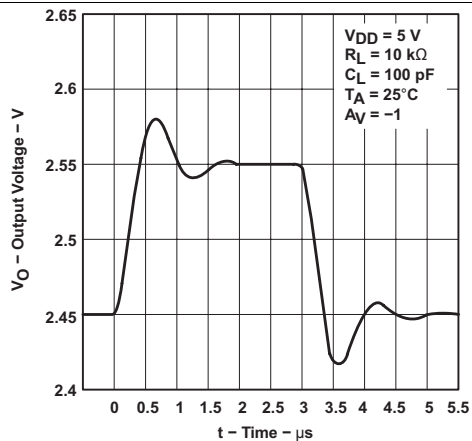

Figure 46. Inverting Small-Signal Pulse Response

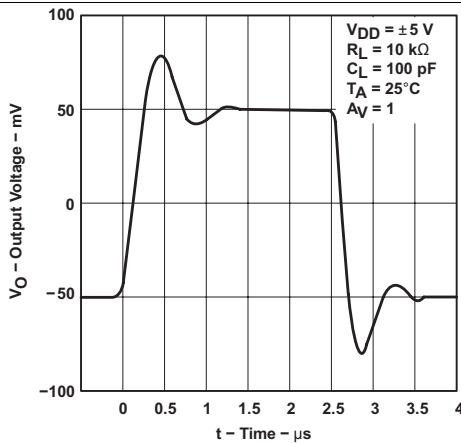

Figure 47. Inverting Small-Signal Pulse Response

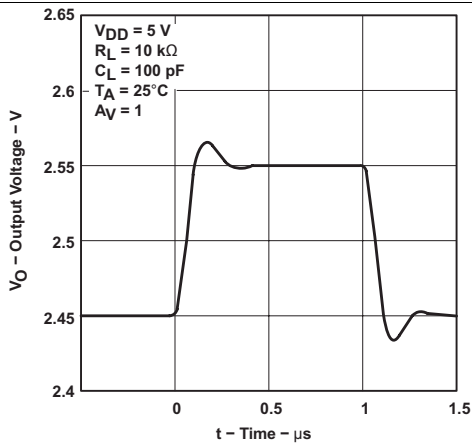

Figure 48. Voltage-Follower Small-Signal Pulse Response

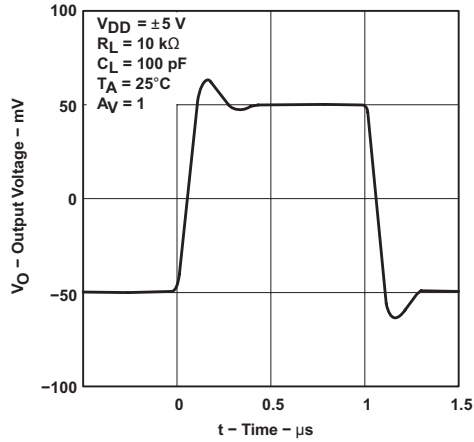

Figure 49. Voltage-Follower Small-Signal Pulse Response

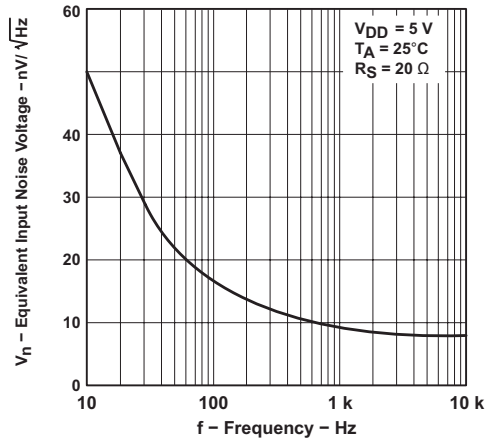

Figure 50. Equivalent Input Noise Voltage vs Frequency

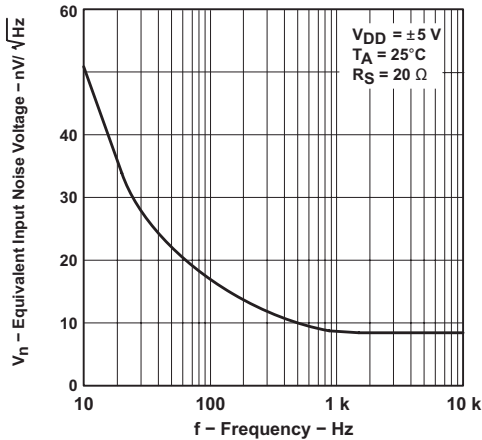

Figure 51. Equivalent Input Noise Voltage vs Frequency

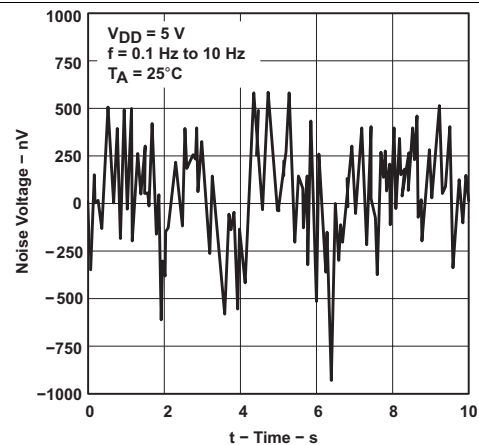

Figure 52. Noise Voltage Over a 10 Second Period

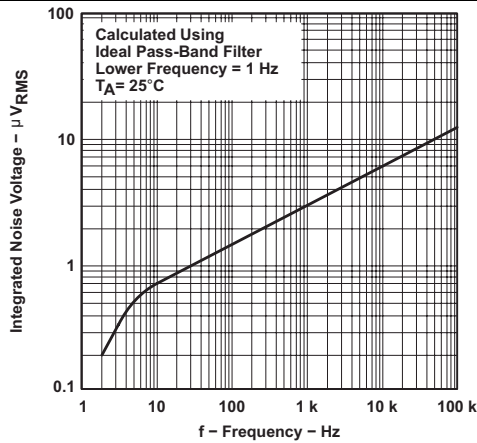

Figure 53. Integrated Noise Voltage vs Frequency

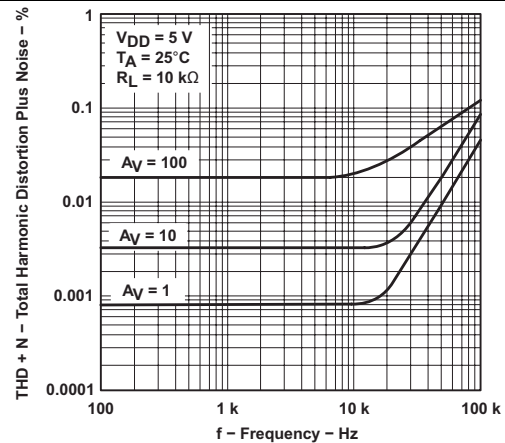

Figure 54. Total Harmonic Distortion + Noise vs Frequency

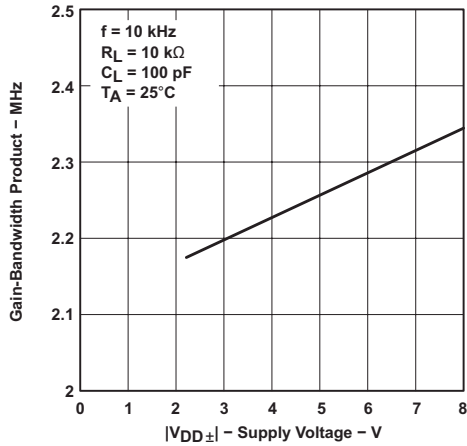

Figure 55. Gain-Bandwidth Product vs Supply Voltage

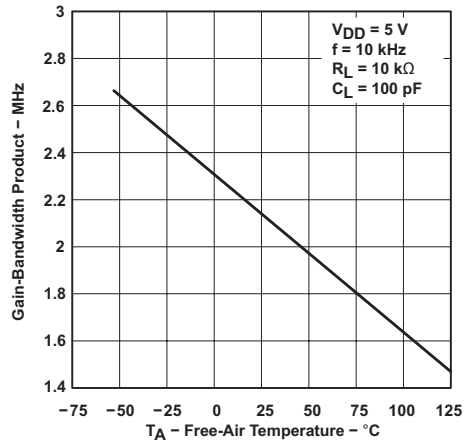

Figure 56. Gain-Bandwidth Product vs Free-Air Temperature

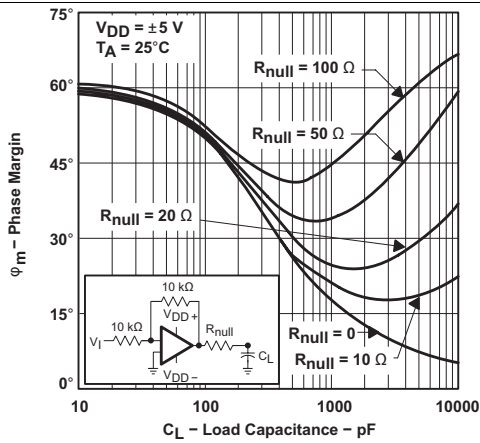

Figure 57. Phase Margin vs Load Capacitance

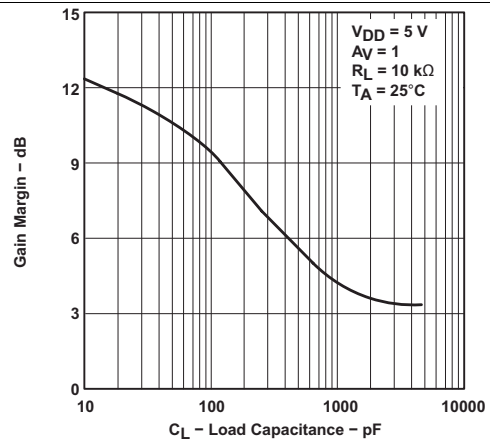

Figure 58. Gain Margin vs Load Capacitance

## 7 Detailed Description

### 7.1 Overview

The TLC227x and TLC227xA families of devices are rail-to-rail output operational amplifiers. These devices operate from 4.4-V to 16-V single supply and  $\pm 2.2$ -V  $\pm 8$ -V dual supply, are unity-gain stable, and are suitable for a wide range of general-purpose applications.

### 7.2 Functional Block Diagram

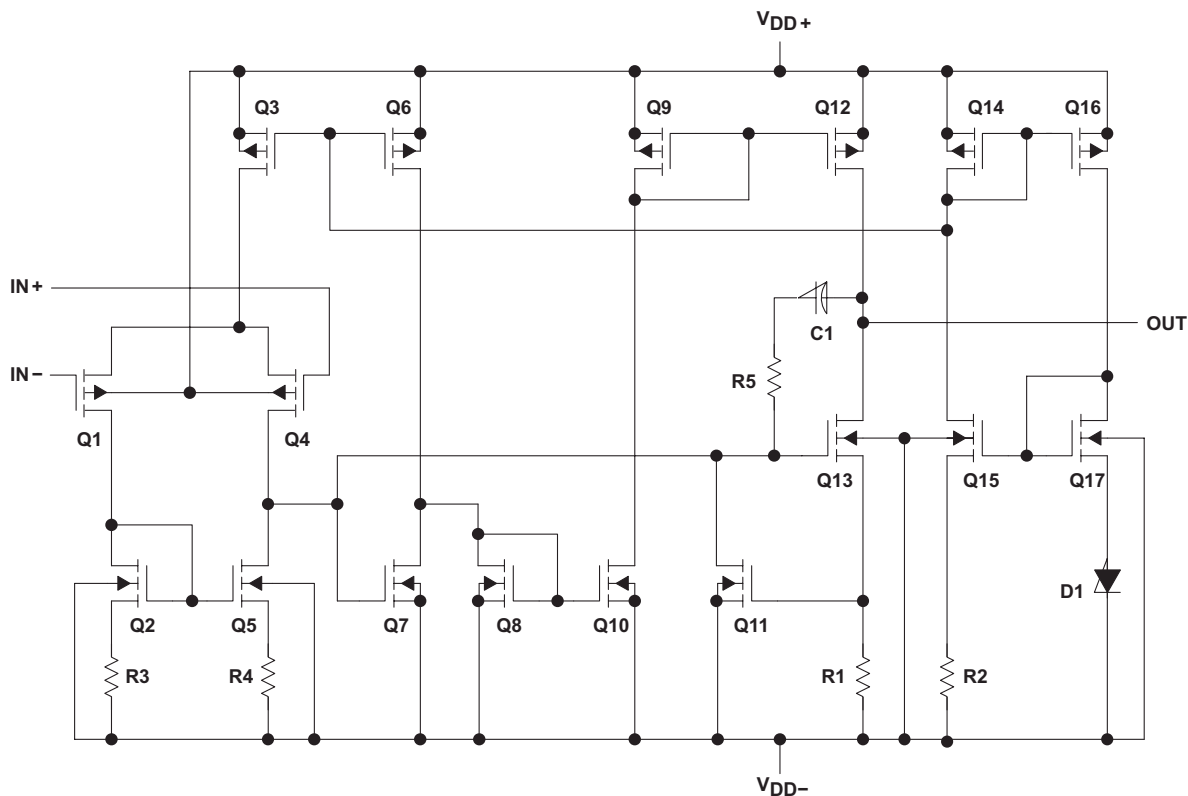

Table 2. Device Component Count<sup>(1)</sup>

| Component   | TLC2272 | TLC2274 |
|-------------|---------|---------|
| Transistors | 38      | 76      |
| Resistors   | 26      | 52      |
| Diodes      | 9       | 18      |
| Capacitors  | 3       | 6       |

(1) Includes both amplifiers and all ESD, bias, and trim circuitry.

### 7.3 Feature Description

The TLC227x and TLC227xA family of devices feature 2-MHz bandwidth and voltage noise of  $9 \text{ nV}/\sqrt{\text{Hz}}$  with performance rated from 4.4 V to 16 V across an automotive temperature range ( $-40^\circ\text{C}$  to  $125^\circ\text{C}$ ). LinMOS suits a wide range of audio, automotive, industrial, and instrumentation applications.

### 7.4 Device Functional Modes

The TLC227x and TLC227xA families of devices is powered on when the supply is connected. The devices may operate with single or dual supply, depending on the application. The devices are in its full performance once the supply is above the recommended value.



## 8 Application and Implementation

### NOTE

Information in the following applications sections is not part of the TI component specification, and TI does not warrant its accuracy or completeness. TI's customers are responsible for determining suitability of components for their purposes. Customers should validate and test their design implementation to confirm system functionality.

### 8.1 Application Information

#### 8.1.1 Macromodel Information

Macromodel information provided was derived using MicroSim Parts™, the model generation software used with MicroSim PSpice™. The Boyle macromodel <sup>(1)</sup> and subcircuit in Figure 59 were generated using the TLC227x typical electrical and operating characteristics at  $T_A = 25^\circ\text{C}$ . Using this information, output simulations of the following key parameters can be generated to a tolerance of 20% (in most cases):

- Maximum positive output voltage swing
- Maximum negative output voltage swing
- Slew rate
- Quiescent power dissipation
- Input bias current
- Open-loop voltage amplification
- Unity gain frequency
- Common-mode rejection ratio
- Phase margin
- DC output resistance
- AC output resistance
- Short-circuit output current limit

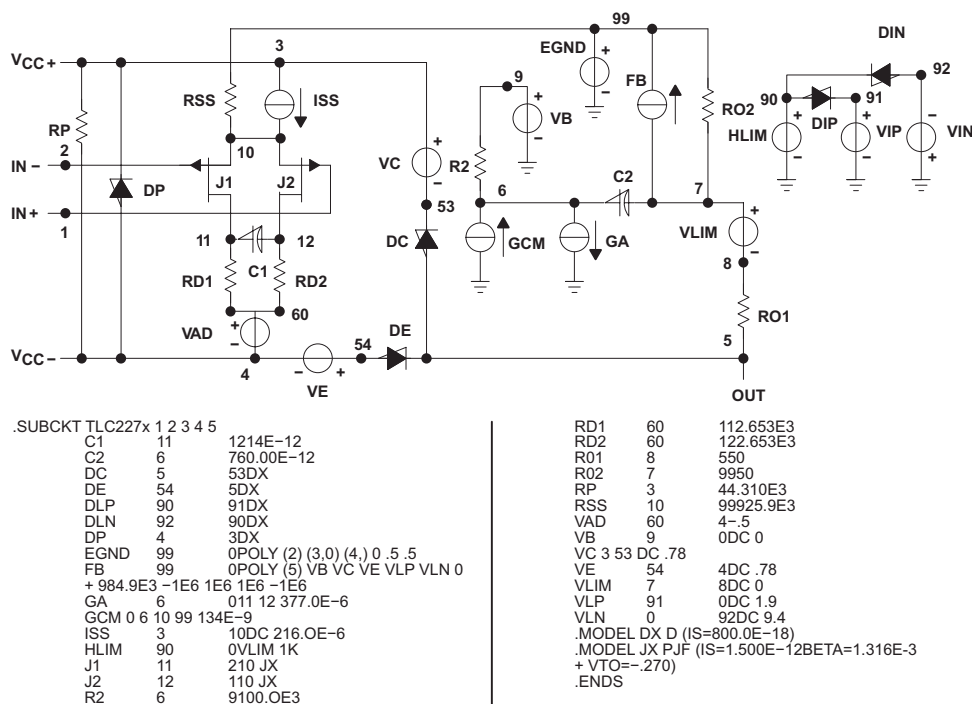

Figure 59. Boyle Macromodel and Subcircuit

(1) *Macromodeling of Integrated Circuit Operational Amplifiers*, IEEE Journal of Solid-State Circuits, SC-9, 353 (1974).

## 8.2 Typical Application

### 8.2.1 High-Side Current Monitor

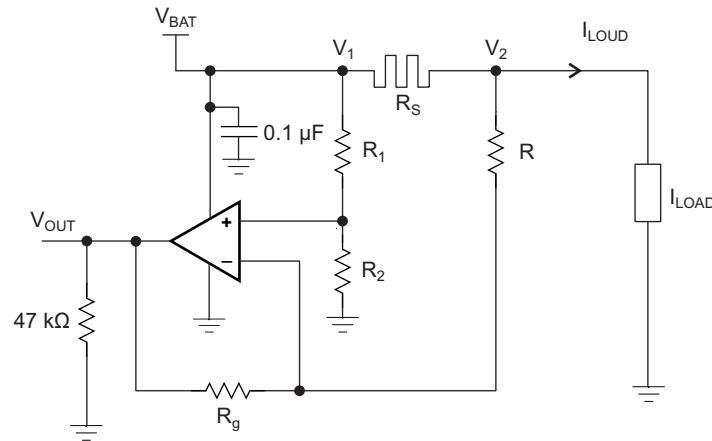

Figure 60. Equivalent Schematic (Each Amplifier)

#### 8.2.1.1 Design Requirements

For this design example, use the parameters listed in [Table 3](#) as the input parameters.

Table 3. Design Parameters

| PARAMETER   |                       | VALUE  |
|-------------|-----------------------|--|
| $V_{BAT}$   | Battery Voltage       | 12 V   |
| $R_{SENSE}$ | Sense Resistor        | 0.1 $\Omega$                                     |
| $I_{LOAD}$  | Load Current          | 0 A to 10 A                                      |
|             | Operational Amplifier | Set in Differential configuration with Gain = 10 |

#### 8.2.1.2 Detailed Design Procedure

This circuit is designed for measuring the high-side current in automotive body control modules with 12-V battery or similar applications. The operational amplifier is set as differential with an external resistor network.

##### 8.2.1.2.1 Differential Amplifier Equations

[Equation 1](#) and [Equation 2](#) are used to calculate  $V_{OUT}$ .

$$V_{OUT} = \frac{R_g}{R} \left( \frac{\frac{R}{R_g} - \frac{R_1}{R_2}}{1 + \frac{R_1}{R_2}} \times \frac{V_1 + V_2}{2} + \frac{1 + \frac{1}{2} \left( \frac{R_1}{R_2} + \frac{R}{R_g} \right)}{1 + \frac{R_1}{R_2}} (V_1 - V_2) \right) \quad (1)$$

$$V_{OUT} = \frac{R_g}{R} \left( \frac{\frac{R}{R_g} - \frac{R_1}{R_2}}{1 + \frac{R_1}{R_2}} \times V_{BAT} + \frac{1 + \frac{1}{2} \left( \frac{R_1}{R_2} + \frac{R}{R_g} \right)}{1 + \frac{R_1}{R_2}} \times R_S \times I_{Load} \right) \quad (2)$$

In an ideal case  $R_1 = R$  and  $R_2 = R_g$ , and  $V_{OUT}$  can then be calculated using [Equation 3](#):

$$V_{OUT} = \frac{R_g}{R} \times R_S \times I_{Load} \quad (3)$$

However, as the resistors have tolerances, they cannot be perfectly matched.

$$\begin{aligned}
 R_1 &= R \pm \Delta R_1 \\
 R_2 &= R_2 \pm \Delta R_2 \\
 R &= R \pm \Delta R \\
 R_g &= R_g \pm \Delta R_g \\
 \text{Tol} &= \frac{\Delta R}{R}
 \end{aligned}
 \tag{4}$$

By developing the equations and neglecting the second order, the worst case is when the tolerances add up. This is shown by [Equation 5](#).

$$V_{\text{OUT}} = \pm (4 \text{ Tol}) \frac{R_g}{R + R_g} \times V_{\text{BAT}} + \left( 1 \pm 2 \text{ Tol} \left( 1 + \frac{2R}{R + R_g} \right) \right) \frac{R_g}{R} \times R_S \times I_{\text{LOAD}}$$

where

- Tol = 0.01 for 1%
- Tol = 0.001 for 0.1%

(5)

If the resistors are perfectly matched, then Tol = 0 and  $V_{\text{OUT}}$  is calculated using [Equation 6](#).

$$V_{\text{OUT}} = \frac{R_g}{R} \times R_S \times I_{\text{LOAD}}$$
(6)

The highest error is from the Common mode, as shown in [Equation 7](#).

$$4 (\text{Tol}) \frac{R_g}{R + R_g} \times V_{\text{BAT}}$$
(7)

Gain of 10,  $R_g / R = 10$ , and Tol = 1%:

$$\text{Common mode error} = ((4 \times 0.01) / 1.1) \times 12 \text{ V} = 0.436 \text{ V}$$

Gain of 10 and Tol = 0.1%:

$$\text{Common mode error} = 43.6 \text{ mV}$$

The resistors were chosen from 2% batches.

$R_1$  and R 12 k $\Omega$

$R_2$  and  $R_g$  120 k $\Omega$

Ideal Gain = 120 / 12 = 10

The measured value of the resistors:

$R_1 = 11.835 \text{ k}\Omega$

$R = 11.85 \text{ k}\Omega$

$R_2 = 117.92 \text{ k}\Omega$

$R_g = 118.07 \text{ k}\Omega$

### 8.2.1.3 Application Curves

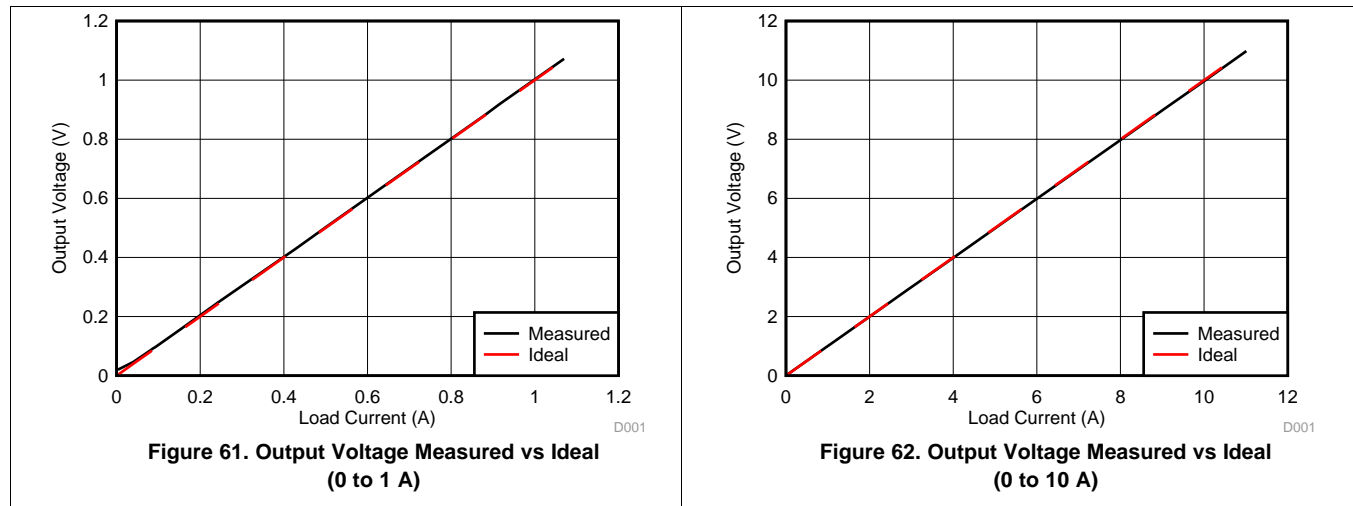

## 9 Power Supply Recommendations

Supply voltage for a single supply is from 4.4 V to 16 V, and from  $\pm 2.2$  V to  $\pm 8$  V for dual supply. In the high-side sensing application, the supply is connected to a 12-V battery.

## 10 Layout

### 10.1 Layout Guidelines

The TLC227x and TLC227xA families of devices are wideband amplifiers. To realize the full operational performance of the devices, good high-frequency printed-circuit-board (PCB) layout practices are required. Low-loss 0.1- $\mu$ F bypass capacitors must be connected between each supply pin and ground as close to the device as possible. The bypass capacitor traces should be designed for minimum inductance.

### 10.2 Layout Example

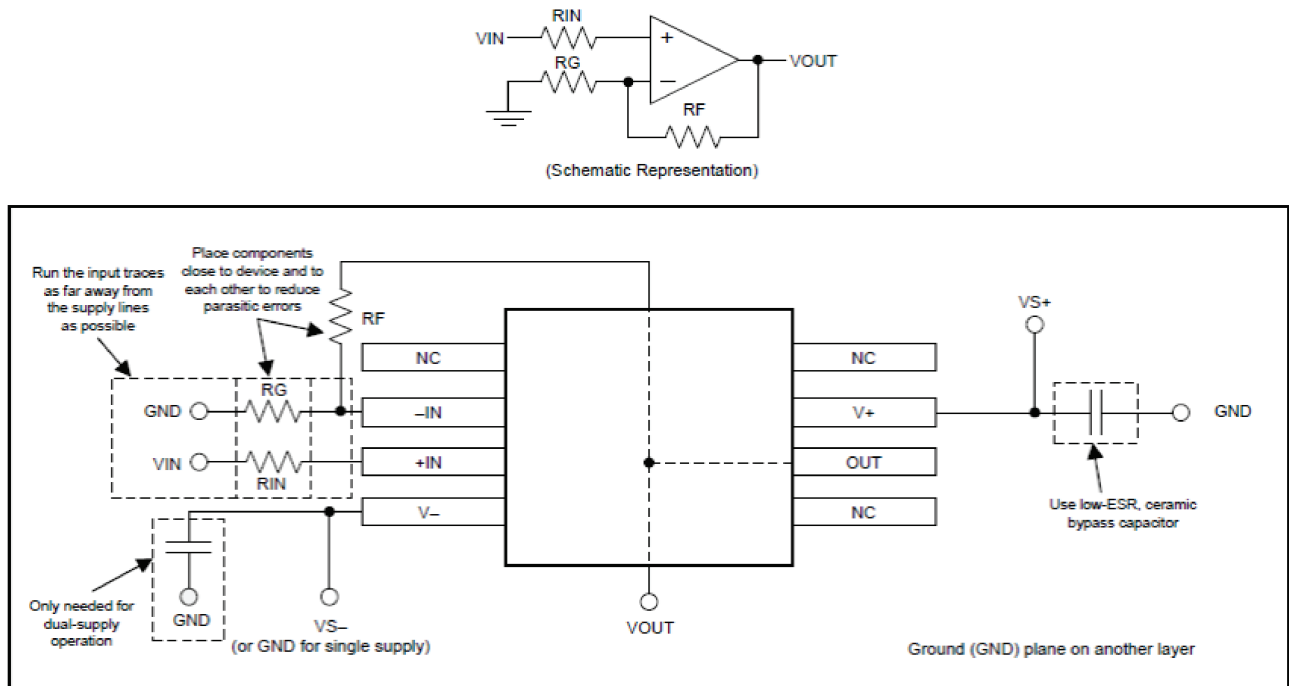

Figure 63. Layout Example

## 11 Device and Documentation Support

### 11.1 Related Links

The table below lists quick access links. Categories include technical documents, support and community resources, tools and software, and quick access to sample or buy.

Table 4. Related Links

| PARTS     | PRODUCT FOLDER             | SAMPLE & BUY               | TECHNICAL DOCUMENTS        | TOOLS & SOFTWARE           | SUPPORT & COMMUNITY        |
|-----------|----------------------------|----------------------------|----------------------------|----------------------------|----------------------------|
| TLC2272   | <a href="#">Click here</a> | <a href="#">Click here</a> | <a href="#">Click here</a> | <a href="#">Click here</a> | <a href="#">Click here</a> |
| TLC2272A  | <a href="#">Click here</a> | <a href="#">Click here</a> | <a href="#">Click here</a> | <a href="#">Click here</a> | <a href="#">Click here</a> |
| TLC2272M  | <a href="#">Click here</a> | <a href="#">Click here</a> | <a href="#">Click here</a> | <a href="#">Click here</a> | <a href="#">Click here</a> |
| TLC2272AM | <a href="#">Click here</a> | <a href="#">Click here</a> | <a href="#">Click here</a> | <a href="#">Click here</a> | <a href="#">Click here</a> |
| TLC2274   | <a href="#">Click here</a> | <a href="#">Click here</a> | <a href="#">Click here</a> | <a href="#">Click here</a> | <a href="#">Click here</a> |
| TLC2274A  | <a href="#">Click here</a> | <a href="#">Click here</a> | <a href="#">Click here</a> | <a href="#">Click here</a> | <a href="#">Click here</a> |
| TLC2274M  | <a href="#">Click here</a> | <a href="#">Click here</a> | <a href="#">Click here</a> | <a href="#">Click here</a> | <a href="#">Click here</a> |
| TLC2274AM | <a href="#">Click here</a> | <a href="#">Click here</a> | <a href="#">Click here</a> | <a href="#">Click here</a> | <a href="#">Click here</a> |

### 11.2 Community Resources

The following links connect to TI community resources. Linked contents are provided "AS IS" by the respective contributors. They do not constitute TI specifications and do not necessarily reflect TI's views; see TI's [Terms of Use](#).

**TI E2E™ Online Community** *TI's Engineer-to-Engineer (E2E) Community*. Created to foster collaboration among engineers. At [e2e.ti.com](http://e2e.ti.com), you can ask questions, share knowledge, explore ideas and help solve problems with fellow engineers.

**Design Support** *TI's Design Support* Quickly find helpful E2E forums along with design support tools and contact information for technical support.

### 11.3 Trademarks

E2E is a trademark of Texas Instruments.  
 MicroSim Parts, PSpice are trademarks of MicroSim.  
 All other trademarks are the property of their respective owners.

### 11.4 Electrostatic Discharge Caution



These devices have limited built-in ESD protection. The leads should be shorted together or the device placed in conductive foam during storage or handling to prevent electrostatic damage to the MOS gates.

### 11.5 Glossary

[SLYZ022](#) — *TI Glossary*.

This glossary lists and explains terms, acronyms, and definitions.

## 12 Mechanical, Packaging, and Orderable Information

The following pages include mechanical, packaging, and orderable information. This information is the most current data available for the designated devices. This data is subject to change without notice and revision of this document. For browser-based versions of this data sheet, refer to the left-hand navigation.

**PACKAGING INFORMATION**

| Orderable Device | Status<br>(1) | Package Type | Package Drawing | Pins | Package Qty | Eco Plan<br>(2)         | Lead/Ball Finish<br>(6) | MSL Peak Temp<br>(3) | Op Temp (°C) | Device Marking<br>(4/5) | Samples                 |
|------------------|---------------|--------------|-----------------|------|-------------|-------------------------|-------------------------|----------------------|--------------|-------------------------|-------------------------|
| TLC2272ACD       | ACTIVE        | SOIC         | D               | 8    | 75          | Green (RoHS & no Sb/Br) | CU NIPDAU               | Level-1-260C-UNLIM   |              | 2272AC                  | <a href="#">Samples</a> |
| TLC2272ACDG4     | ACTIVE        | SOIC         | D               | 8    | 75          | Green (RoHS & no Sb/Br) | CU NIPDAU               | Level-1-260C-UNLIM   |              | 2272AC                  | <a href="#">Samples</a> |
| TLC2272ACDR      | ACTIVE        | SOIC         | D               | 8    | 2500        | Green (RoHS & no Sb/Br) | CU NIPDAU               | Level-1-260C-UNLIM   |              | 2272AC                  | <a href="#">Samples</a> |
| TLC2272ACDRG4    | ACTIVE        | SOIC         | D               | 8    | 2500        | Green (RoHS & no Sb/Br) | CU NIPDAU               | Level-1-260C-UNLIM   |              | 2272AC                  | <a href="#">Samples</a> |
| TLC2272ACP       | ACTIVE        | PDIP         | P               | 8    | 50          | Pb-Free (RoHS)          | CU NIPDAU               | N / A for Pkg Type   |              | TLC2272AC               | <a href="#">Samples</a> |
| TLC2272ACPE4     | ACTIVE        | PDIP         | P               | 8    | 50          | Pb-Free (RoHS)          | CU NIPDAU               | N / A for Pkg Type   |              | TLC2272AC               | <a href="#">Samples</a> |
| TLC2272ACPW      | ACTIVE        | TSSOP        | PW              | 8    | 150         | Green (RoHS & no Sb/Br) | CU NIPDAU               | Level-1-260C-UNLIM   |              | P2272A                  | <a href="#">Samples</a> |
| TLC2272ACPWG4    | ACTIVE        | TSSOP        | PW              | 8    | 150         | Green (RoHS & no Sb/Br) | CU NIPDAU               | Level-1-260C-UNLIM   |              | P2272A                  | <a href="#">Samples</a> |
| TLC2272ACPWR     | ACTIVE        | TSSOP        | PW              | 8    | 2000        | Green (RoHS & no Sb/Br) | CU NIPDAU               | Level-1-260C-UNLIM   |              | P2272A                  | <a href="#">Samples</a> |
| TLC2272ACPWRG4   | ACTIVE        | TSSOP        | PW              | 8    | 2000        | Green (RoHS & no Sb/Br) | CU NIPDAU               | Level-1-260C-UNLIM   |              | P2272A                  | <a href="#">Samples</a> |
| TLC2272AID       | ACTIVE        | SOIC         | D               | 8    | 75          | Green (RoHS & no Sb/Br) | CU NIPDAU               | Level-1-260C-UNLIM   |              | 2272AI                  | <a href="#">Samples</a> |
| TLC2272AIDG4     | ACTIVE        | SOIC         | D               | 8    | 75          | Green (RoHS & no Sb/Br) | CU NIPDAU               | Level-1-260C-UNLIM   |              | 2272AI                  | <a href="#">Samples</a> |
| TLC2272AIDR      | ACTIVE        | SOIC         | D               | 8    | 2500        | Green (RoHS & no Sb/Br) | CU NIPDAU               | Level-1-260C-UNLIM   |              | 2272AI                  | <a href="#">Samples</a> |
| TLC2272AIDRG4    | ACTIVE        | SOIC         | D               | 8    | 2500        | Green (RoHS & no Sb/Br) | CU NIPDAU               | Level-1-260C-UNLIM   |              | 2272AI                  | <a href="#">Samples</a> |
| TLC2272AIP       | ACTIVE        | PDIP         | P               | 8    | 50          | Pb-Free (RoHS)          | CU NIPDAU               | N / A for Pkg Type   |              | TLC2272AI               | <a href="#">Samples</a> |
| TLC2272AIPE4     | ACTIVE        | PDIP         | P               | 8    | 50          | Pb-Free (RoHS)          | CU NIPDAU               | N / A for Pkg Type   |              | TLC2272AI               | <a href="#">Samples</a> |
| TLC2272AMD       | ACTIVE        | SOIC         | D               | 8    | 75          | Green (RoHS & no Sb/Br) | CU NIPDAU               | Level-1-260C-UNLIM   | -55 to 125   | 2272AM                  | <a href="#">Samples</a> |

| Orderable Device | Status<br>(1) | Package Type | Package<br>Drawing | Pins | Package<br>Qty | Eco Plan<br>(2)            | Lead/Ball Finish<br>(6) | MSL Peak Temp<br>(3) | Op Temp (°C) | Device Marking<br>(4/5) | Samples                 |
|------------------|---------------|--------------|--------------------|------|----------------|----------------------------|-------------------------|----------------------|--------------|-------------------------|-------------------------|
| TLC2272AMDG4     | ACTIVE        | SOIC         | D                  | 8    | 75             | Green (RoHS<br>& no Sb/Br) | CU NIPDAU               | Level-1-260C-UNLIM   |              | 2272AM                  | <a href="#">Samples</a> |
| TLC2272AMDR      | ACTIVE        | SOIC         | D                  | 8    | 2500           | Green (RoHS<br>& no Sb/Br) | CU NIPDAU               | Level-1-260C-UNLIM   | -55 to 125   | 2272AM                  | <a href="#">Samples</a> |
| TLC2272AMDRG4    | ACTIVE        | SOIC         | D                  | 8    | 2500           | Green (RoHS<br>& no Sb/Br) | CU NIPDAU               | Level-1-260C-UNLIM   |              | 2272AM                  | <a href="#">Samples</a> |
| TLC2272AQD       | ACTIVE        | SOIC         | D                  | 8    | 75             | Green (RoHS<br>& no Sb/Br) | CU NIPDAU               | Level-1-260C-UNLIM   | -40 to 125   | C2272A                  | <a href="#">Samples</a> |
| TLC2272AQDG4     | ACTIVE        | SOIC         | D                  | 8    | 75             | Green (RoHS<br>& no Sb/Br) | CU NIPDAU               | Level-1-260C-UNLIM   |              | C2272A                  | <a href="#">Samples</a> |
| TLC2272AQDR      | ACTIVE        | SOIC         | D                  | 8    | 2500           | Green (RoHS<br>& no Sb/Br) | CU NIPDAU               | Level-1-260C-UNLIM   | -40 to 125   | C2272A                  | <a href="#">Samples</a> |
| TLC2272AQDRG4    | ACTIVE        | SOIC         | D                  | 8    | 2500           | Green (RoHS<br>& no Sb/Br) | CU NIPDAU               | Level-1-260C-UNLIM   |              | C2272A                  | <a href="#">Samples</a> |
| TLC2272CD        | ACTIVE        | SOIC         | D                  | 8    | 75             | Green (RoHS<br>& no Sb/Br) | CU NIPDAU               | Level-1-260C-UNLIM   | 0 to 70      | 2272C                   | <a href="#">Samples</a> |
| TLC2272CDG4      | ACTIVE        | SOIC         | D                  | 8    | 75             | Green (RoHS<br>& no Sb/Br) | CU NIPDAU               | Level-1-260C-UNLIM   | 0 to 70      | 2272C                   | <a href="#">Samples</a> |
| TLC2272CDR       | ACTIVE        | SOIC         | D                  | 8    | 2500           | Green (RoHS<br>& no Sb/Br) | CU NIPDAU               | Level-1-260C-UNLIM   | 0 to 70      | 2272C                   | <a href="#">Samples</a> |
| TLC2272CDRG4     | ACTIVE        | SOIC         | D                  | 8    | 2500           | Green (RoHS<br>& no Sb/Br) | CU NIPDAU               | Level-1-260C-UNLIM   | 0 to 70      | 2272C                   | <a href="#">Samples</a> |
| TLC2272CP        | ACTIVE        | PDIP         | P                  | 8    | 50             | Pb-Free<br>(RoHS)          | CU NIPDAU               | N / A for Pkg Type   | 0 to 70      | TLC2272CP               | <a href="#">Samples</a> |
| TLC2272CPE4      | ACTIVE        | PDIP         | P                  | 8    | 50             | Pb-Free<br>(RoHS)          | CU NIPDAU               | N / A for Pkg Type   | 0 to 70      | TLC2272CP               | <a href="#">Samples</a> |
| TLC2272CPSR      | ACTIVE        | SO           | PS                 | 8    | 2000           | Green (RoHS<br>& no Sb/Br) | CU NIPDAU               | Level-1-260C-UNLIM   | 0 to 70      | P2272                   | <a href="#">Samples</a> |
| TLC2272CPW       | ACTIVE        | TSSOP        | PW                 | 8    | 150            | Green (RoHS<br>& no Sb/Br) | CU NIPDAU               | Level-1-260C-UNLIM   | 0 to 70      | P2272                   | <a href="#">Samples</a> |
| TLC2272CPWG4     | ACTIVE        | TSSOP        | PW                 | 8    | 150            | Green (RoHS<br>& no Sb/Br) | CU NIPDAU               | Level-1-260C-UNLIM   | 0 to 70      | P2272                   | <a href="#">Samples</a> |
| TLC2272CPWR      | ACTIVE        | TSSOP        | PW                 | 8    | 2000           | Green (RoHS<br>& no Sb/Br) | CU NIPDAU               | Level-1-260C-UNLIM   | 0 to 70      | P2272                   | <a href="#">Samples</a> |
| TLC2272CPWRG4    | ACTIVE        | TSSOP        | PW                 | 8    | 2000           | Green (RoHS<br>& no Sb/Br) | CU NIPDAU               | Level-1-260C-UNLIM   | 0 to 70      | P2272                   | <a href="#">Samples</a> |



| Orderable Device | Status<br>(1) | Package Type | Package<br>Drawing | Pins | Package<br>Qty | Eco Plan<br>(2)            | Lead/Ball Finish<br>(6) | MSL Peak Temp<br>(3) | Op Temp (°C) | Device Marking<br>(4/5) | Samples                 |
|------------------|---------------|--------------|--------------------|------|----------------|----------------------------|-------------------------|----------------------|--------------|-------------------------|-------------------------|
| TLC2272ID        | ACTIVE        | SOIC         | D                  | 8    | 75             | Green (RoHS<br>& no Sb/Br) | CU NIPDAU               | Level-1-260C-UNLIM   |              | 2272I                   | <a href="#">Samples</a> |
| TLC2272IDG4      | ACTIVE        | SOIC         | D                  | 8    | 75             | Green (RoHS<br>& no Sb/Br) | CU NIPDAU               | Level-1-260C-UNLIM   |              | 2272I                   | <a href="#">Samples</a> |
| TLC2272IDR       | ACTIVE        | SOIC         | D                  | 8    | 2500           | Green (RoHS<br>& no Sb/Br) | CU NIPDAU               | Level-1-260C-UNLIM   |              | 2272I                   | <a href="#">Samples</a> |
| TLC2272IDRG4     | ACTIVE        | SOIC         | D                  | 8    | 2500           | Green (RoHS<br>& no Sb/Br) | CU NIPDAU               | Level-1-260C-UNLIM   |              | 2272I                   | <a href="#">Samples</a> |
| TLC2272IP        | ACTIVE        | PDIP         | P                  | 8    | 50             | Pb-Free<br>(RoHS)          | CU NIPDAU               | N / A for Pkg Type   |              | TLC2272IP               | <a href="#">Samples</a> |
| TLC2272IPE4      | ACTIVE        | PDIP         | P                  | 8    | 50             | Pb-Free<br>(RoHS)          | CU NIPDAU               | N / A for Pkg Type   |              | TLC2272IP               | <a href="#">Samples</a> |
| TLC2272IPW       | ACTIVE        | TSSOP        | PW                 | 8    | 150            | Green (RoHS<br>& no Sb/Br) | CU NIPDAU               | Level-1-260C-UNLIM   |              | Y2272                   | <a href="#">Samples</a> |
| TLC2272IPWG4     | ACTIVE        | TSSOP        | PW                 | 8    | 150            | Green (RoHS<br>& no Sb/Br) | CU NIPDAU               | Level-1-260C-UNLIM   |              | Y2272                   | <a href="#">Samples</a> |
| TLC2272IPWR      | ACTIVE        | TSSOP        | PW                 | 8    | 2000           | Green (RoHS<br>& no Sb/Br) | CU NIPDAU               | Level-1-260C-UNLIM   |              | Y2272                   | <a href="#">Samples</a> |
| TLC2272IPWRG4    | ACTIVE        | TSSOP        | PW                 | 8    | 2000           | Green (RoHS<br>& no Sb/Br) | CU NIPDAU               | Level-1-260C-UNLIM   |              | Y2272                   | <a href="#">Samples</a> |
| TLC2272MD        | ACTIVE        | SOIC         | D                  | 8    | 75             | Green (RoHS<br>& no Sb/Br) | CU NIPDAU               | Level-1-260C-UNLIM   | -55 to 125   | 2272M                   | <a href="#">Samples</a> |
| TLC2272MDG4      | ACTIVE        | SOIC         | D                  | 8    | 75             | Green (RoHS<br>& no Sb/Br) | CU NIPDAU               | Level-1-260C-UNLIM   |              | 2272M                   | <a href="#">Samples</a> |
| TLC2272MDR       | ACTIVE        | SOIC         | D                  | 8    | 2500           | Green (RoHS<br>& no Sb/Br) | CU NIPDAU               | Level-1-260C-UNLIM   | -55 to 125   | 2272M                   | <a href="#">Samples</a> |
| TLC2272MDRG4     | ACTIVE        | SOIC         | D                  | 8    | 2500           | Green (RoHS<br>& no Sb/Br) | CU NIPDAU               | Level-1-260C-UNLIM   |              | 2272M                   | <a href="#">Samples</a> |
| TLC2272QDG4      | ACTIVE        | SOIC         | D                  | 8    | 75             | Green (RoHS<br>& no Sb/Br) | CU NIPDAU               | Level-1-260C-UNLIM   |              | C2272Q                  | <a href="#">Samples</a> |
| TLC2272QDR       | ACTIVE        | SOIC         | D                  | 8    | 2500           | Green (RoHS<br>& no Sb/Br) | CU NIPDAU               | Level-1-260C-UNLIM   | -40 to 125   | C2272Q                  | <a href="#">Samples</a> |
| TLC2272QPWRG4    | ACTIVE        | TSSOP        | PW                 | 8    | 2000           | Green (RoHS<br>& no Sb/Br) | CU NIPDAU               | Level-1-260C-UNLIM   |              | T2272Q                  | <a href="#">Samples</a> |
| TLC2274ACD       | ACTIVE        | SOIC         | D                  | 14   | 50             | Green (RoHS<br>& no Sb/Br) | CU NIPDAU               | Level-1-260C-UNLIM   | 0 to 70      | 2274AC                  | <a href="#">Samples</a> |

| Orderable Device | Status<br>(1) | Package Type | Package<br>Drawing | Pins | Package<br>Qty | Eco Plan<br>(2)            | Lead/Ball Finish<br>(6) | MSL Peak Temp<br>(3) | Op Temp (°C) | Device Marking<br>(4/5) | Samples                 |
|------------------|---------------|--------------|--------------------|------|----------------|----------------------------|-------------------------|----------------------|--------------|-------------------------|-------------------------|
| TLC2274ACDG4     | ACTIVE        | SOIC         | D                  | 14   | 50             | Green (RoHS<br>& no Sb/Br) | CU NIPDAU               | Level-1-260C-UNLIM   | 0 to 70      | 2274AC                  | <a href="#">Samples</a> |
| TLC2274ACDR      | ACTIVE        | SOIC         | D                  | 14   | 2500           | Green (RoHS<br>& no Sb/Br) | CU NIPDAU               | Level-1-260C-UNLIM   | 0 to 70      | 2274AC                  | <a href="#">Samples</a> |
| TLC2274ACDRG4    | ACTIVE        | SOIC         | D                  | 14   | 2500           | Green (RoHS<br>& no Sb/Br) | CU NIPDAU               | Level-1-260C-UNLIM   | 0 to 70      | 2274AC                  | <a href="#">Samples</a> |
| TLC2274ACN       | ACTIVE        | PDIP         | N                  | 14   | 25             | Pb-Free<br>(RoHS)          | CU NIPDAU               | N / A for Pkg Type   | 0 to 70      | TLC2274ACN              | <a href="#">Samples</a> |
| TLC2274ACNE4     | ACTIVE        | PDIP         | N                  | 14   | 25             | Pb-Free<br>(RoHS)          | CU NIPDAU               | N / A for Pkg Type   | 0 to 70      | TLC2274ACN              | <a href="#">Samples</a> |
| TLC2274ACPW      | ACTIVE        | TSSOP        | PW                 | 14   | 90             | Green (RoHS<br>& no Sb/Br) | CU NIPDAU               | Level-1-260C-UNLIM   | 0 to 70      | P2274A                  | <a href="#">Samples</a> |
| TLC2274ACPWG4    | ACTIVE        | TSSOP        | PW                 | 14   | 90             | Green (RoHS<br>& no Sb/Br) | CU NIPDAU               | Level-1-260C-UNLIM   | 0 to 70      | P2274A                  | <a href="#">Samples</a> |
| TLC2274ACPWR     | ACTIVE        | TSSOP        | PW                 | 14   | 2000           | Green (RoHS<br>& no Sb/Br) | CU NIPDAU               | Level-1-260C-UNLIM   | 0 to 70      | P2274A                  | <a href="#">Samples</a> |
| TLC2274ACPWRG4   | ACTIVE        | TSSOP        | PW                 | 14   | 2000           | Green (RoHS<br>& no Sb/Br) | CU NIPDAU               | Level-1-260C-UNLIM   | 0 to 70      | P2274A                  | <a href="#">Samples</a> |
| TLC2274AID       | ACTIVE        | SOIC         | D                  | 14   | 50             | Green (RoHS<br>& no Sb/Br) | CU NIPDAU               | Level-1-260C-UNLIM   | -40 to 125   | 2274AI                  | <a href="#">Samples</a> |
| TLC2274AIDG4     | ACTIVE        | SOIC         | D                  | 14   | 50             | Green (RoHS<br>& no Sb/Br) | CU NIPDAU               | Level-1-260C-UNLIM   | -40 to 125   | 2274AI                  | <a href="#">Samples</a> |
| TLC2274AIDR      | ACTIVE        | SOIC         | D                  | 14   | 2500           | Green (RoHS<br>& no Sb/Br) | CU NIPDAU               | Level-1-260C-UNLIM   | -40 to 125   | 2274AI                  | <a href="#">Samples</a> |
| TLC2274AIDRG4    | ACTIVE        | SOIC         | D                  | 14   | 2500           | Green (RoHS<br>& no Sb/Br) | CU NIPDAU               | Level-1-260C-UNLIM   | -40 to 125   | 2274AI                  | <a href="#">Samples</a> |
| TLC2274AIN       | ACTIVE        | PDIP         | N                  | 14   | 25             | Pb-Free<br>(RoHS)          | CU NIPDAU               | N / A for Pkg Type   | -40 to 125   | TLC2274AIN              | <a href="#">Samples</a> |
| TLC2274AINE4     | ACTIVE        | PDIP         | N                  | 14   | 25             | Pb-Free<br>(RoHS)          | CU NIPDAU               | N / A for Pkg Type   | -40 to 125   | TLC2274AIN              | <a href="#">Samples</a> |
| TLC2274AIPW      | ACTIVE        | TSSOP        | PW                 | 14   | 90             | Green (RoHS<br>& no Sb/Br) | CU NIPDAU               | Level-1-260C-UNLIM   | -40 to 125   | Y2274A                  | <a href="#">Samples</a> |
| TLC2274AIPWG4    | ACTIVE        | TSSOP        | PW                 | 14   | 90             | Green (RoHS<br>& no Sb/Br) | CU NIPDAU               | Level-1-260C-UNLIM   | -40 to 125   | Y2274A                  | <a href="#">Samples</a> |
| TLC2274AIPWR     | ACTIVE        | TSSOP        | PW                 | 14   | 2000           | Green (RoHS<br>& no Sb/Br) | CU NIPDAU               | Level-1-260C-UNLIM   | -40 to 125   | Y2274A                  | <a href="#">Samples</a> |

| Orderable Device | Status<br>(1) | Package Type | Package<br>Drawing | Pins | Package<br>Qty | Eco Plan<br>(2)            | Lead/Ball Finish<br>(6) | MSL Peak Temp<br>(3) | Op Temp (°C) | Device Marking<br>(4/5) | Samples                 |
|------------------|---------------|--------------|--------------------|------|----------------|----------------------------|-------------------------|----------------------|--------------|-------------------------|-------------------------|
| TLC2274AIPWRG4   | ACTIVE        | TSSOP        | PW                 | 14   | 2000           | Green (RoHS<br>& no Sb/Br) | CU NIPDAU               | Level-1-260C-UNLIM   | -40 to 125   | Y2274A                  | <a href="#">Samples</a> |
| TLC2274AMD       | ACTIVE        | SOIC         | D                  | 14   | 50             | Green (RoHS<br>& no Sb/Br) | CU NIPDAU               | Level-1-260C-UNLIM   | -55 to 125   | 2274AM                  | <a href="#">Samples</a> |
| TLC2274AMDG4     | ACTIVE        | SOIC         | D                  | 14   | 50             | Green (RoHS<br>& no Sb/Br) | CU NIPDAU               | Level-1-260C-UNLIM   |              | 2274AM                  | <a href="#">Samples</a> |
| TLC2274AMDRG4    | ACTIVE        | SOIC         | D                  | 14   | 2500           | Green (RoHS<br>& no Sb/Br) | CU NIPDAU               | Level-1-260C-UNLIM   |              | 2274AM                  | <a href="#">Samples</a> |
| TLC2274AQD       | ACTIVE        | SOIC         | D                  | 14   | 50             | Green (RoHS<br>& no Sb/Br) | CU NIPDAU               | Level-1-260C-UNLIM   | -40 to 125   | TLC2274A                | <a href="#">Samples</a> |
| TLC2274AQDG4     | ACTIVE        | SOIC         | D                  | 14   | 50             | Green (RoHS<br>& no Sb/Br) | CU NIPDAU               | Level-1-260C-UNLIM   |              | PJ2274A                 | <a href="#">Samples</a> |
| TLC2274AQDR      | ACTIVE        | SOIC         | D                  | 14   | 2500           | Green (RoHS<br>& no Sb/Br) | CU NIPDAU               | Level-1-260C-UNLIM   | -40 to 125   | TLC2274A                | <a href="#">Samples</a> |
| TLC2274AQDRG4    | ACTIVE        | SOIC         | D                  | 14   | 2500           | Green (RoHS<br>& no Sb/Br) | CU NIPDAU               | Level-1-260C-UNLIM   |              | PJ2274A                 | <a href="#">Samples</a> |
| TLC2274CD        | ACTIVE        | SOIC         | D                  | 14   | 50             | Green (RoHS<br>& no Sb/Br) | CU NIPDAU               | Level-1-260C-UNLIM   |              | TLC2274C                | <a href="#">Samples</a> |
| TLC2274CDG4      | ACTIVE        | SOIC         | D                  | 14   | 50             | Green (RoHS<br>& no Sb/Br) | CU NIPDAU               | Level-1-260C-UNLIM   |              | TLC2274C                | <a href="#">Samples</a> |
| TLC2274CDR       | ACTIVE        | SOIC         | D                  | 14   | 2500           | Green (RoHS<br>& no Sb/Br) | CU NIPDAU               | Level-1-260C-UNLIM   |              | TLC2274C                | <a href="#">Samples</a> |
| TLC2274CDRG4     | ACTIVE        | SOIC         | D                  | 14   | 2500           | Green (RoHS<br>& no Sb/Br) | CU NIPDAU               | Level-1-260C-UNLIM   |              | TLC2274C                | <a href="#">Samples</a> |
| TLC2274CN        | ACTIVE        | PDIP         | N                  | 14   | 25             | Pb-Free<br>(RoHS)          | CU NIPDAU               | N / A for Pkg Type   |              | TLC2274CN               | <a href="#">Samples</a> |
| TLC2274CNE4      | ACTIVE        | PDIP         | N                  | 14   | 25             | Pb-Free<br>(RoHS)          | CU NIPDAU               | N / A for Pkg Type   |              | TLC2274CN               | <a href="#">Samples</a> |
| TLC2274CNSR      | ACTIVE        | SO           | NS                 | 14   | 2000           | Green (RoHS<br>& no Sb/Br) | CU NIPDAU               | Level-1-260C-UNLIM   |              | TLC2274                 | <a href="#">Samples</a> |
| TLC2274CPW       | ACTIVE        | TSSOP        | PW                 | 14   | 90             | Green (RoHS<br>& no Sb/Br) | CU NIPDAU               | Level-1-260C-UNLIM   |              | P2274                   | <a href="#">Samples</a> |
| TLC2274CPWG4     | ACTIVE        | TSSOP        | PW                 | 14   | 90             | Green (RoHS<br>& no Sb/Br) | CU NIPDAU               | Level-1-260C-UNLIM   |              | P2274                   | <a href="#">Samples</a> |
| TLC2274CPWR      | ACTIVE        | TSSOP        | PW                 | 14   | 2000           | Green (RoHS<br>& no Sb/Br) | CU NIPDAU               | Level-1-260C-UNLIM   |              | P2274                   | <a href="#">Samples</a> |

| Orderable Device | Status<br>(1) | Package Type | Package<br>Drawing | Pins | Package<br>Qty | Eco Plan<br>(2)            | Lead/Ball Finish<br>(6) | MSL Peak Temp<br>(3) | Op Temp (°C) | Device Marking<br>(4/5) | Samples                 |
|------------------|---------------|--------------|--------------------|------|----------------|----------------------------|-------------------------|----------------------|--------------|-------------------------|-------------------------|
| TLC2274CPWRG4    | ACTIVE        | TSSOP        | PW                 | 14   | 2000           | Green (RoHS<br>& no Sb/Br) | CU NIPDAU               | Level-1-260C-UNLIM   | 0 to 70      | P2274                   | <a href="#">Samples</a> |
| TLC2274ID        | ACTIVE        | SOIC         | D                  | 14   | 50             | Green (RoHS<br>& no Sb/Br) | CU NIPDAU               | Level-1-260C-UNLIM   |              | TLC2274I                | <a href="#">Samples</a> |
| TLC2274IDG4      | ACTIVE        | SOIC         | D                  | 14   | 50             | Green (RoHS<br>& no Sb/Br) | CU NIPDAU               | Level-1-260C-UNLIM   |              | TLC2274I                | <a href="#">Samples</a> |
| TLC2274IDR       | ACTIVE        | SOIC         | D                  | 14   | 2500           | Green (RoHS<br>& no Sb/Br) | CU NIPDAU               | Level-1-260C-UNLIM   |              | TLC2274I                | <a href="#">Samples</a> |
| TLC2274IDRG4     | ACTIVE        | SOIC         | D                  | 14   | 2500           | Green (RoHS<br>& no Sb/Br) | CU NIPDAU               | Level-1-260C-UNLIM   |              | TLC2274I                | <a href="#">Samples</a> |
| TLC2274IN        | ACTIVE        | PDIP         | N                  | 14   | 25             | Pb-Free<br>(RoHS)          | CU NIPDAU               | N / A for Pkg Type   |              | TLC2274IN               | <a href="#">Samples</a> |
| TLC2274IPW       | ACTIVE        | TSSOP        | PW                 | 14   | 90             | Green (RoHS<br>& no Sb/Br) | CU NIPDAU               | Level-1-260C-UNLIM   |              | Y2274                   | <a href="#">Samples</a> |
| TLC2274IPWG4     | ACTIVE        | TSSOP        | PW                 | 14   | 90             | Green (RoHS<br>& no Sb/Br) | CU NIPDAU               | Level-1-260C-UNLIM   |              | Y2274                   | <a href="#">Samples</a> |
| TLC2274IPWR      | ACTIVE        | TSSOP        | PW                 | 14   | 2000           | Green (RoHS<br>& no Sb/Br) | CU NIPDAU               | Level-1-260C-UNLIM   |              | Y2274                   | <a href="#">Samples</a> |
| TLC2274IPWRG4    | ACTIVE        | TSSOP        | PW                 | 14   | 2000           | Green (RoHS<br>& no Sb/Br) | CU NIPDAU               | Level-1-260C-UNLIM   |              | Y2274                   | <a href="#">Samples</a> |
| TLC2274MD        | ACTIVE        | SOIC         | D                  | 14   | 50             | Green (RoHS<br>& no Sb/Br) | CU NIPDAU               | Level-1-260C-UNLIM   | -55 to 125   | TLC2274M                | <a href="#">Samples</a> |
| TLC2274MDG4      | ACTIVE        | SOIC         | D                  | 14   | 50             | Green (RoHS<br>& no Sb/Br) | CU NIPDAU               | Level-1-260C-UNLIM   |              | PJ2274M                 | <a href="#">Samples</a> |
| TLC2274MDR       | ACTIVE        | SOIC         | D                  | 14   | 2500           | Green (RoHS<br>& no Sb/Br) | CU NIPDAU               | Level-1-260C-UNLIM   | -55 to 125   | TLC2274M                | <a href="#">Samples</a> |
| TLC2274MDRG4     | ACTIVE        | SOIC         | D                  | 14   | 2500           | Green (RoHS<br>& no Sb/Br) | CU NIPDAU               | Level-1-260C-UNLIM   |              | PJ2274M                 | <a href="#">Samples</a> |
| TLC2274MN        | ACTIVE        | PDIP         | N                  | 14   | 25             | Pb-Free<br>(RoHS)          | CU NIPDAU               | N / A for Pkg Type   | -55 to 125   | TLC2274MN               | <a href="#">Samples</a> |
| TLC2274QD        | ACTIVE        | SOIC         | D                  | 14   | 50             | Green (RoHS<br>& no Sb/Br) | CU NIPDAU               | Level-1-260C-UNLIM   | -40 to 125   | TLC2274                 | <a href="#">Samples</a> |
| TLC2274QDG4      | ACTIVE        | SOIC         | D                  | 14   | 50             | Green (RoHS<br>& no Sb/Br) | CU NIPDAU               | Level-1-260C-UNLIM   |              | TLC2274                 | <a href="#">Samples</a> |
| TLC2274QDRG4     | ACTIVE        | SOIC         | D                  | 14   | 2500           | Green (RoHS<br>& no Sb/Br) | CU NIPDAU               | Level-1-260C-UNLIM   |              | TLC2274                 | <a href="#">Samples</a> |

(1) The marketing status values are defined as follows:

**ACTIVE:** Product device recommended for new designs.

**LIFEBUY:** TI has announced that the device will be discontinued, and a lifetime-buy period is in effect.

**NRND:** Not recommended for new designs. Device is in production to support existing customers, but TI does not recommend using this part in a new design.

**PREVIEW:** Device has been announced but is not in production. Samples may or may not be available.

**OBSOLETE:** TI has discontinued the production of the device.

(2) **RoHS:** TI defines "RoHS" to mean semiconductor products that are compliant with the current EU RoHS requirements for all 10 RoHS substances, including the requirement that RoHS substance do not exceed 0.1% by weight in homogeneous materials. Where designed to be soldered at high temperatures, "RoHS" products are suitable for use in specified lead-free processes. TI may reference these types of products as "Pb-Free".

**RoHS Exempt:** TI defines "RoHS Exempt" to mean products that contain lead but are compliant with EU RoHS pursuant to a specific EU RoHS exemption.

**Green:** TI defines "Green" to mean the content of Chlorine (Cl) and Bromine (Br) based flame retardants meet JS709B low halogen requirements of  $\leq 1000$ ppm threshold. Antimony trioxide based flame retardants must also meet the  $\leq 1000$ ppm threshold requirement.

(3) MSL, Peak Temp. - The Moisture Sensitivity Level rating according to the JEDEC industry standard classifications, and peak solder temperature.

(4) There may be additional marking, which relates to the logo, the lot trace code information, or the environmental category on the device.

(5) Multiple Device Markings will be inside parentheses. Only one Device Marking contained in parentheses and separated by a "~" will appear on a device. If a line is indented then it is a continuation of the previous line and the two combined represent the entire Device Marking for that device.

(6) Lead/Ball Finish - Orderable Devices may have multiple material finish options. Finish options are separated by a vertical ruled line. Lead/Ball Finish values may wrap to two lines if the finish value exceeds the maximum column width.

**Important Information and Disclaimer:** The information provided on this page represents TI's knowledge and belief as of the date that it is provided. TI bases its knowledge and belief on information provided by third parties, and makes no representation or warranty as to the accuracy of such information. Efforts are underway to better integrate information from third parties. TI has taken and continues to take reasonable steps to provide representative and accurate information but may not have conducted destructive testing or chemical analysis on incoming materials and chemicals. TI and TI suppliers consider certain information to be proprietary, and thus CAS numbers and other limited information may not be available for release.

In no event shall TI's liability arising out of such information exceed the total purchase price of the TI part(s) at issue in this document sold by TI to Customer on an annual basis.

**OTHER QUALIFIED VERSIONS OF TLC2272, TLC2272A, TLC2272AM, TLC2272M, TLC2274, TLC2274A, TLC2274AM, TLC2274M :**

● Catalog: [TLC2272A](#), [TLC2272](#), [TLC2274A](#), [TLC2274](#)

● Automotive: [TLC2272-Q1](#), [TLC2272A-Q1](#), [TLC2272A-Q1](#), [TLC2272-Q1](#), [TLC2274-Q1](#), [TLC2274A-Q1](#), [TLC2274A-Q1](#), [TLC2274-Q1](#)

● Enhanced Product: [TLC2272A-EP](#), [TLC2272A-EP](#), [TLC2274-EP](#), [TLC2274A-EP](#), [TLC2274A-EP](#), [TLC2274-EP](#)

- Military: [TLC2272M](#), [TLC2272AM](#), [TLC2274M](#), [TLC2274AM](#)

NOTE: Qualified Version Definitions:

- Catalog - TI's standard catalog product
- Automotive - Q100 devices qualified for high-reliability automotive applications targeting zero defects
- Enhanced Product - Supports Defense, Aerospace and Medical Applications
- Military - QML certified for Military and Defense Applications

**TAPE AND REEL INFORMATION**

**QUADRANT ASSIGNMENTS FOR PIN 1 ORIENTATION IN TAPE**

\*All dimensions are nominal

| Device        | Package Type | Package Drawing | Pins | SPQ  | Reel Diameter (mm) | Reel Width W1 (mm) | A0 (mm) | B0 (mm) | K0 (mm) | P1 (mm) | W (mm) | Pin1 Quadrant |
|---------------|--------------|-----------------|------|------|--------------------|--------------------|---------|---------|---------|---------|--------|---------------|
| TLC2272ACDR   | SOIC         | D               | 8    | 2500 | 330.0              | 12.4               | 6.4     | 5.2     | 2.1     | 8.0     | 12.0   | Q1            |
| TLC2272ACPWR  | TSSOP        | PW              | 8    | 2000 | 330.0              | 12.4               | 7.0     | 3.6     | 1.6     | 8.0     | 12.0   | Q1            |
| TLC2272AIDR   | SOIC         | D               | 8    | 2500 | 330.0              | 12.4               | 6.4     | 5.2     | 2.1     | 8.0     | 12.0   | Q1            |
| TLC2272AMDR   | SOIC         | D               | 8    | 2500 | 330.0              | 12.4               | 6.4     | 5.2     | 2.1     | 8.0     | 12.0   | Q1            |
| TLC2272AMDRG4 | SOIC         | D               | 8    | 2500 | 330.0              | 12.4               | 6.4     | 5.2     | 2.1     | 8.0     | 12.0   | Q1            |
| TLC2272AQDR   | SOIC         | D               | 8    | 2500 | 330.0              | 12.5               | 6.4     | 5.2     | 2.1     | 8.0     | 12.0   | Q1            |
| TLC2272CDR    | SOIC         | D               | 8    | 2500 | 330.0              | 12.4               | 6.4     | 5.2     | 2.1     | 8.0     | 12.0   | Q1            |
| TLC2272CPWR   | TSSOP        | PW              | 8    | 2000 | 330.0              | 12.4               | 7.0     | 3.6     | 1.6     | 8.0     | 12.0   | Q1            |
| TLC2272IDR    | SOIC         | D               | 8    | 2500 | 330.0              | 12.4               | 6.4     | 5.2     | 2.1     | 8.0     | 12.0   | Q1            |
| TLC2272IPWR   | TSSOP        | PW              | 8    | 2000 | 330.0              | 12.4               | 7.0     | 3.6     | 1.6     | 8.0     | 12.0   | Q1            |
| TLC2272MDR    | SOIC         | D               | 8    | 2500 | 330.0              | 12.4               | 6.4     | 5.2     | 2.1     | 8.0     | 12.0   | Q1            |
| TLC2272QDR    | SOIC         | D               | 8    | 2500 | 330.0              | 12.5               | 6.4     | 5.2     | 2.1     | 8.0     | 12.0   | Q1            |
| TLC2272QPWRG4 | TSSOP        | PW              | 8    | 2000 | 330.0              | 12.4               | 7.0     | 3.6     | 1.6     | 8.0     | 12.0   | Q1            |
| TLC2274ACDR   | SOIC         | D               | 14   | 2500 | 330.0              | 16.4               | 6.5     | 9.0     | 2.1     | 8.0     | 16.0   | Q1            |
| TLC2274ACPWR  | TSSOP        | PW              | 14   | 2000 | 330.0              | 12.4               | 6.9     | 5.6     | 1.6     | 8.0     | 12.0   | Q1            |
| TLC2274AIDR   | SOIC         | D               | 14   | 2500 | 330.0              | 16.4               | 6.5     | 9.0     | 2.1     | 8.0     | 16.0   | Q1            |
| TLC2274AIPWR  | TSSOP        | PW              | 14   | 2000 | 330.0              | 12.4               | 6.9     | 5.6     | 1.6     | 8.0     | 12.0   | Q1            |
| TLC2274AQDR   | SOIC         | D               | 14   | 2500 | 330.0              | 16.4               | 6.5     | 9.0     | 2.1     | 8.0     | 16.0   | Q1            |

| Device       | Package Type | Package Drawing | Pins | SPQ  | Reel Diameter (mm) | Reel Width W1 (mm) | A0 (mm) | B0 (mm) | K0 (mm) | P1 (mm) | W (mm) | Pin1 Quadrant |
|--------------|--------------|-----------------|------|------|--------------------|--------------------|---------|---------|---------|---------|--------|---------------|
| TLC2274CDR   | SOIC         | D               | 14   | 2500 | 330.0              | 16.4               | 6.5     | 9.0     | 2.1     | 8.0     | 16.0   | Q1            |
| TLC2274CNSR  | SO           | NS              | 14   | 2000 | 330.0              | 16.4               | 8.2     | 10.5    | 2.5     | 12.0    | 16.0   | Q1            |
| TLC2274CPWR  | TSSOP        | PW              | 14   | 2000 | 330.0              | 12.4               | 6.9     | 5.6     | 1.6     | 8.0     | 12.0   | Q1            |
| TLC2274IDR   | SOIC         | D               | 14   | 2500 | 330.0              | 16.4               | 6.5     | 9.0     | 2.1     | 8.0     | 16.0   | Q1            |
| TLC2274IPWR  | TSSOP        | PW              | 14   | 2000 | 330.0              | 12.4               | 6.9     | 5.6     | 1.6     | 8.0     | 12.0   | Q1            |
| TLC2274MDR   | SOIC         | D               | 14   | 2500 | 330.0              | 16.4               | 6.5     | 9.0     | 2.1     | 8.0     | 16.0   | Q1            |
| TLC2274MDRG4 | SOIC         | D               | 14   | 2500 | 330.0              | 16.4               | 6.5     | 9.0     | 2.1     | 8.0     | 16.0   | Q1            |
| TLC2274QDRG4 | SOIC         | D               | 14   | 2500 | 330.0              | 16.4               | 6.5     | 9.0     | 2.1     | 8.0     | 16.0   | Q1            |

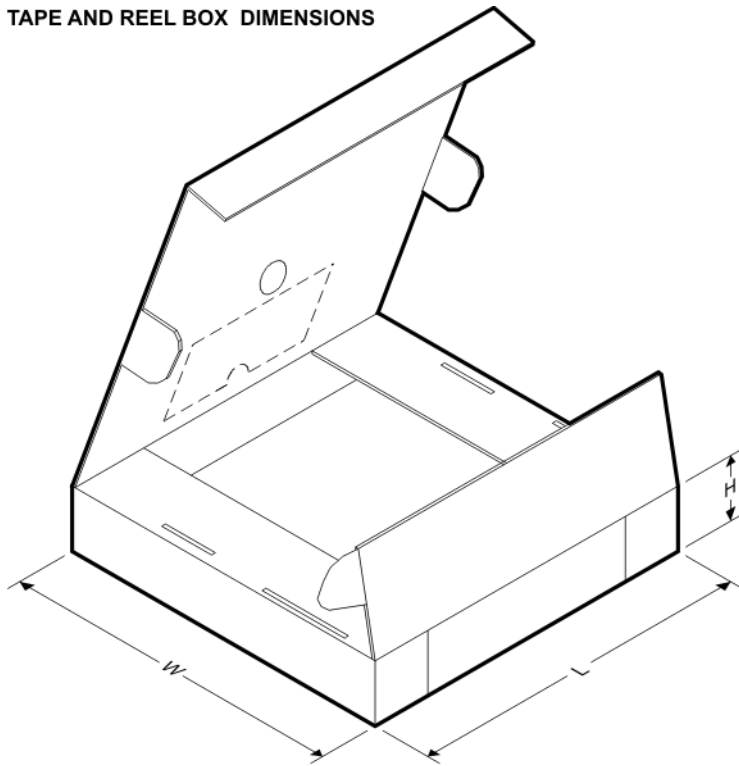
**TAPE AND REEL BOX DIMENSIONS**

\*All dimensions are nominal

| Device        | Package Type | Package Drawing | Pins | SPQ  | Length (mm) | Width (mm) | Height (mm) |
|---------------|--------------|-----------------|------|------|-------------|------------|-------------|
| TLC2272ACDR   | SOIC         | D               | 8    | 2500 | 340.5       | 338.1      | 20.6        |
| TLC2272ACPWR  | TSSOP        | PW              | 8    | 2000 | 367.0       | 367.0      | 35.0        |
| TLC2272AIDR   | SOIC         | D               | 8    | 2500 | 340.5       | 338.1      | 20.6        |
| TLC2272AMDR   | SOIC         | D               | 8    | 2500 | 367.0       | 367.0      | 38.0        |
| TLC2272AMDRG4 | SOIC         | D               | 8    | 2500 | 367.0       | 367.0      | 38.0        |
| TLC2272AQDR   | SOIC         | D               | 8    | 2500 | 340.5       | 338.1      | 20.6        |
| TLC2272CDR    | SOIC         | D               | 8    | 2500 | 340.5       | 338.1      | 20.6        |
| TLC2272CPWR   | TSSOP        | PW              | 8    | 2000 | 367.0       | 367.0      | 35.0        |
| TLC2272IDR    | SOIC         | D               | 8    | 2500 | 340.5       | 338.1      | 20.6        |



| Device        | Package Type | Package Drawing | Pins | SPQ  | Length (mm) | Width (mm) | Height (mm) |
|---------------|--------------|-----------------|------|------|-------------|------------|-------------|
| TLC2272IPWR   | TSSOP        | PW              | 8    | 2000 | 367.0       | 367.0      | 35.0        |
| TLC2272MDR    | SOIC         | D               | 8    | 2500 | 367.0       | 367.0      | 38.0        |
| TLC2272QDR    | SOIC         | D               | 8    | 2500 | 340.5       | 338.1      | 20.6        |
| TLC2272QPWRG4 | TSSOP        | PW              | 8    | 2000 | 367.0       | 367.0      | 35.0        |
| TLC2274ACDR   | SOIC         | D               | 14   | 2500 | 333.2       | 345.9      | 28.6        |
| TLC2274ACPWR  | TSSOP        | PW              | 14   | 2000 | 367.0       | 367.0      | 35.0        |
| TLC2274AIDR   | SOIC         | D               | 14   | 2500 | 333.2       | 345.9      | 28.6        |
| TLC2274AIPWR  | TSSOP        | PW              | 14   | 2000 | 367.0       | 367.0      | 35.0        |
| TLC2274AQDR   | SOIC         | D               | 14   | 2500 | 367.0       | 367.0      | 38.0        |
| TLC2274CDR    | SOIC         | D               | 14   | 2500 | 333.2       | 345.9      | 28.6        |
| TLC2274CNSR   | SO           | NS              | 14   | 2000 | 367.0       | 367.0      | 38.0        |
| TLC2274CPWR   | TSSOP        | PW              | 14   | 2000 | 367.0       | 367.0      | 35.0        |
| TLC2274IDR    | SOIC         | D               | 14   | 2500 | 333.2       | 345.9      | 28.6        |
| TLC2274IPWR   | TSSOP        | PW              | 14   | 2000 | 367.0       | 367.0      | 35.0        |
| TLC2274MDR    | SOIC         | D               | 14   | 2500 | 367.0       | 367.0      | 38.0        |
| TLC2274MDRG4  | SOIC         | D               | 14   | 2500 | 367.0       | 367.0      | 38.0        |
| TLC2274QDRG4  | SOIC         | D               | 14   | 2500 | 367.0       | 367.0      | 38.0        |

# MECHANICAL DATA

NS (R-PDSO-G\*\*)

PLASTIC SMALL-OUTLINE PACKAGE

14-PINS SHOWN



- NOTES:
- A. All linear dimensions are in millimeters.
  - B. This drawing is subject to change without notice.
  - C. Body dimensions do not include mold flash or protrusion, not to exceed 0,15.

D (R-PDSO-G14)

PLASTIC SMALL OUTLINE



- NOTES:
- A. All linear dimensions are in inches (millimeters).
  - B. This drawing is subject to change without notice.
  -  Body length does not include mold flash, protrusions, or gate burrs. Mold flash, protrusions, or gate burrs shall not exceed 0.006 (0,15) each side.
  -  Body width does not include interlead flash. Interlead flash shall not exceed 0.017 (0,43) each side.
  - E. Reference JEDEC MS-012 variation AB.

D (R-PDSO-G14)

PLASTIC SMALL OUTLINE



- NOTES:
- All linear dimensions are in millimeters.
  - This drawing is subject to change without notice.
  - Publication IPC-7351 is recommended for alternate designs.
  - Laser cutting apertures with trapezoidal walls and also rounding corners will offer better paste release. Customers should contact their board assembly site for stencil design recommendations. Refer to IPC-7525 for other stencil recommendations.
  - Customers should contact their board fabrication site for solder mask tolerances between and around signal pads.

# MECHANICAL DATA

PW (R-PDSO-G14)

PLASTIC SMALL OUTLINE

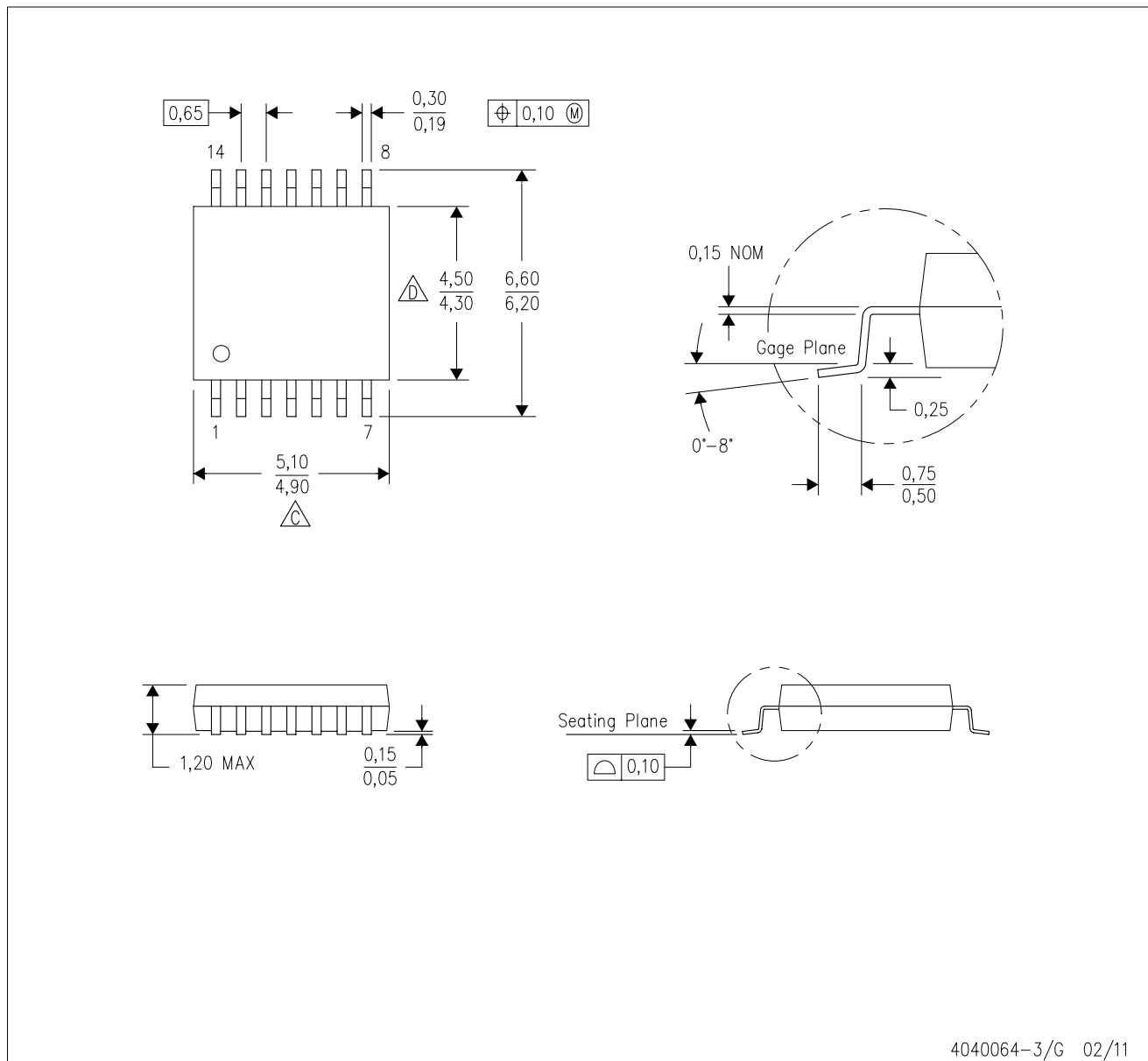

4040064-3/G 02/11

- NOTES:
- A. All linear dimensions are in millimeters. Dimensioning and tolerancing per ASME Y14.5M-1994.
  - B. This drawing is subject to change without notice.
  - C. Body length does not include mold flash, protrusions, or gate burrs. Mold flash, protrusions, or gate burrs shall not exceed 0,15 each side.
  - D. Body width does not include interlead flash. Interlead flash shall not exceed 0,25 each side.
  - E. Falls within JEDEC MO-153

PW (R-PDSO-G14)

PLASTIC SMALL OUTLINE

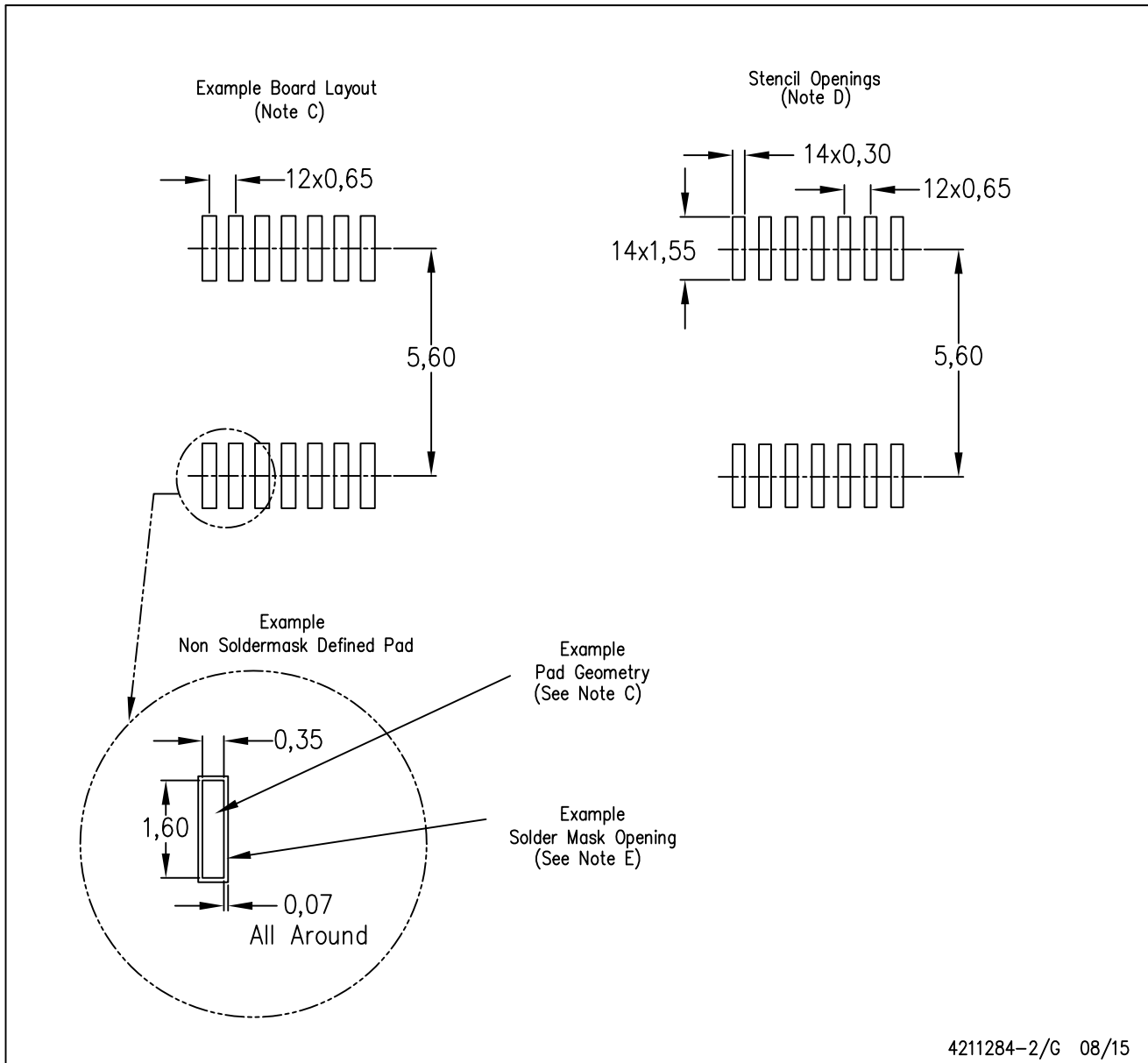

- NOTES:
- All linear dimensions are in millimeters.
  - This drawing is subject to change without notice.
  - Publication IPC-7351 is recommended for alternate designs.
  - Laser cutting apertures with trapezoidal walls and also rounding corners will offer better paste release. Customers should contact their board assembly site for stencil design recommendations. Refer to IPC-7525 for other stencil recommendations.
  - Customers should contact their board fabrication site for solder mask tolerances between and around signal pads.

D (R-PDSO-G8)

PLASTIC SMALL OUTLINE



- NOTES:
- A. All linear dimensions are in inches (millimeters).
  - B. This drawing is subject to change without notice.
  - C. Body length does not include mold flash, protrusions, or gate burrs. Mold flash, protrusions, or gate burrs shall not exceed 0.006 (0,15) each side.
  - D. Body width does not include interlead flash. Interlead flash shall not exceed 0.017 (0,43) each side.
  - E. Reference JEDEC MS-012 variation AA.

D (R-PDSO-G8)

PLASTIC SMALL OUTLINE



- NOTES:
- All linear dimensions are in millimeters.
  - This drawing is subject to change without notice.
  - Publication IPC-7351 is recommended for alternate designs.
  - Laser cutting apertures with trapezoidal walls and also rounding corners will offer better paste release. Customers should contact their board assembly site for stencil design recommendations. Refer to IPC-7525 for other stencil recommendations.
  - Customers should contact their board fabrication site for solder mask tolerances between and around signal pads.



## MECHANICAL DATA

PS (R-PDSO-G8)

PLASTIC SMALL-OUTLINE PACKAGE



- NOTES:
- A. All linear dimensions are in millimeters.
  - B. This drawing is subject to change without notice.
  - C. Body dimensions do not include mold flash or protrusion, not to exceed 0,15.

PS (R-PDSO-G8)

PLASTIC SMALL OUTLINE



- NOTES:
- A. All linear dimensions are in millimeters.
  - B. This drawing is subject to change without notice.
  - C. Publication IPC-7351 is recommended for alternate designs.
  - D. Laser cutting apertures with trapezoidal walls and also rounding corners will offer better paste release. Customers should contact their board assembly site for stencil design recommendations. Refer to IPC-7525 for other stencil recommendations.
  - E. Customers should contact their board fabrication site for solder mask tolerances between and around signal pads.

P (R-PDIP-T8)

PLASTIC DUAL-IN-LINE PACKAGE



4040082/E 04/2010

- NOTES:
- A. All linear dimensions are in inches (millimeters).
  - B. This drawing is subject to change without notice.
  - C. Falls within JEDEC MS-001 variation BA.

N (R-PDIP-T\*\*)

PLASTIC DUAL-IN-LINE PACKAGE

16 PINS SHOWN



- NOTES:
- A. All linear dimensions are in inches (millimeters).
  - B. This drawing is subject to change without notice.
  - C Falls within JEDEC MS-001, except 18 and 20 pin minimum body length (Dim A).
  - D The 20 pin end lead shoulder width is a vendor option, either half or full width.

4040049/E 12/2002

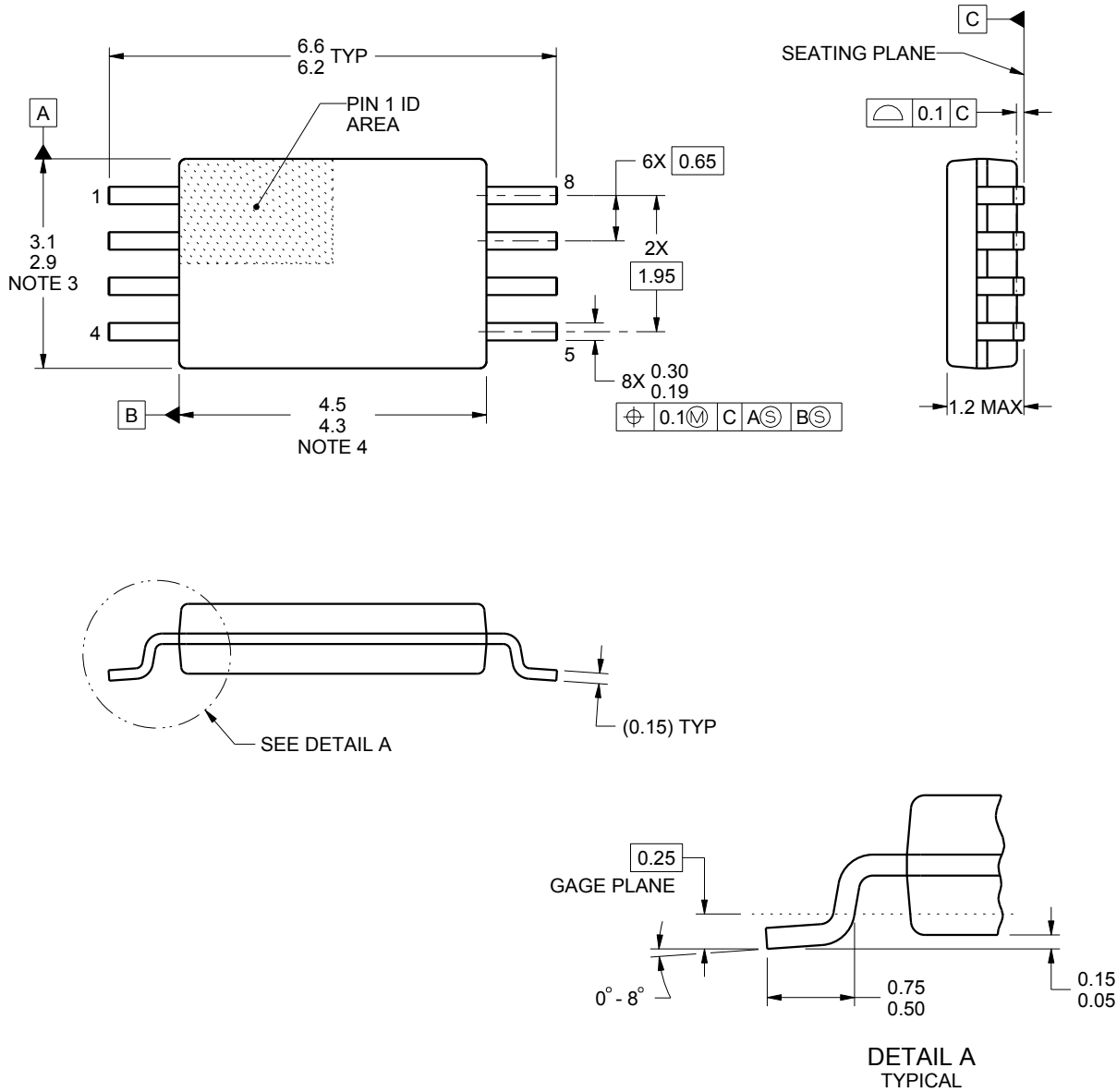
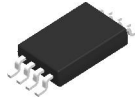

4221848/A 02/2015

NOTES:

1. All linear dimensions are in millimeters. Any dimensions in parenthesis are for reference only. Dimensioning and tolerancing per ASME Y14.5M.
2. This drawing is subject to change without notice.
3. This dimension does not include mold flash, protrusions, or gate burrs. Mold flash, protrusions, or gate burrs shall not exceed 0.15 mm per side.
4. This dimension does not include interlead flash. Interlead flash shall not exceed 0.25 mm per side.
5. Reference JEDEC registration MO-153, variation AA.

# EXAMPLE BOARD LAYOUT

PW0008A

TSSOP - 1.2 mm max height

SMALL OUTLINE PACKAGE



LAND PATTERN EXAMPLE  
SCALE:10X



SOLDER MASK DETAILS  
NOT TO SCALE

4221848/A 02/2015

NOTES: (continued)

- 6. Publication IPC-7351 may have alternate designs.
- 7. Solder mask tolerances between and around signal pads can vary based on board fabrication site.

# EXAMPLE STENCIL DESIGN

PW0008A

TSSOP - 1.2 mm max height

SMALL OUTLINE PACKAGE



SOLDER PASTE EXAMPLE  
BASED ON 0.125 mm THICK STENCIL  
SCALE:10X

4221848/A 02/2015

NOTES: (continued)

8. Laser cutting apertures with trapezoidal walls and rounded corners may offer better paste release. IPC-7525 may have alternate design recommendations.
9. Board assembly site may have different recommendations for stencil design.

## IMPORTANT NOTICE

Texas Instruments Incorporated (TI) reserves the right to make corrections, enhancements, improvements and other changes to its semiconductor products and services per JESD46, latest issue, and to discontinue any product or service per JESD48, latest issue. Buyers should obtain the latest relevant information before placing orders and should verify that such information is current and complete.

TI's published terms of sale for semiconductor products (<http://www.ti.com/sc/docs/stdterms.htm>) apply to the sale of packaged integrated circuit products that TI has qualified and released to market. Additional terms may apply to the use or sale of other types of TI products and services.

Reproduction of significant portions of TI information in TI data sheets is permissible only if reproduction is without alteration and is accompanied by all associated warranties, conditions, limitations, and notices. TI is not responsible or liable for such reproduced documentation. Information of third parties may be subject to additional restrictions. Resale of TI products or services with statements different from or beyond the parameters stated by TI for that product or service voids all express and any implied warranties for the associated TI product or service and is an unfair and deceptive business practice. TI is not responsible or liable for any such statements.

Buyers and others who are developing systems that incorporate TI products (collectively, "Designers") understand and agree that Designers remain responsible for using their independent analysis, evaluation and judgment in designing their applications and that Designers have full and exclusive responsibility to assure the safety of Designers' applications and compliance of their applications (and of all TI products used in or for Designers' applications) with all applicable regulations, laws and other applicable requirements. Designer represents that, with respect to their applications, Designer has all the necessary expertise to create and implement safeguards that (1) anticipate dangerous consequences of failures, (2) monitor failures and their consequences, and (3) lessen the likelihood of failures that might cause harm and take appropriate actions. Designer agrees that prior to using or distributing any applications that include TI products, Designer will thoroughly test such applications and the functionality of such TI products as used in such applications.

TI's provision of technical, application or other design advice, quality characterization, reliability data or other services or information, including, but not limited to, reference designs and materials relating to evaluation modules, (collectively, "TI Resources") are intended to assist designers who are developing applications that incorporate TI products; by downloading, accessing or using TI Resources in any way, Designer (individually or, if Designer is acting on behalf of a company, Designer's company) agrees to use any particular TI Resource solely for this purpose and subject to the terms of this Notice.

TI's provision of TI Resources does not expand or otherwise alter TI's applicable published warranties or warranty disclaimers for TI products, and no additional obligations or liabilities arise from TI providing such TI Resources. TI reserves the right to make corrections, enhancements, improvements and other changes to its TI Resources. TI has not conducted any testing other than that specifically described in the published documentation for a particular TI Resource.

Designer is authorized to use, copy and modify any individual TI Resource only in connection with the development of applications that include the TI product(s) identified in such TI Resource. NO OTHER LICENSE, EXPRESS OR IMPLIED, BY ESTOPPEL OR OTHERWISE TO ANY OTHER TI INTELLECTUAL PROPERTY RIGHT, AND NO LICENSE TO ANY TECHNOLOGY OR INTELLECTUAL PROPERTY RIGHT OF TI OR ANY THIRD PARTY IS GRANTED HEREIN, including but not limited to any patent right, copyright, mask work right, or other intellectual property right relating to any combination, machine, or process in which TI products or services are used. Information regarding or referencing third-party products or services does not constitute a license to use such products or services, or a warranty or endorsement thereof. Use of TI Resources may require a license from a third party under the patents or other intellectual property of the third party, or a license from TI under the patents or other intellectual property of TI.

TI RESOURCES ARE PROVIDED "AS IS" AND WITH ALL FAULTS. TI DISCLAIMS ALL OTHER WARRANTIES OR REPRESENTATIONS, EXPRESS OR IMPLIED, REGARDING RESOURCES OR USE THEREOF, INCLUDING BUT NOT LIMITED TO ACCURACY OR COMPLETENESS, TITLE, ANY EPIDEMIC FAILURE WARRANTY AND ANY IMPLIED WARRANTIES OF MERCHANTABILITY, FITNESS FOR A PARTICULAR PURPOSE, AND NON-INFRINGEMENT OF ANY THIRD PARTY INTELLECTUAL PROPERTY RIGHTS. TI SHALL NOT BE LIABLE FOR AND SHALL NOT DEFEND OR INDEMNIFY DESIGNER AGAINST ANY CLAIM, INCLUDING BUT NOT LIMITED TO ANY INFRINGEMENT CLAIM THAT RELATES TO OR IS BASED ON ANY COMBINATION OF PRODUCTS EVEN IF DESCRIBED IN TI RESOURCES OR OTHERWISE. IN NO EVENT SHALL TI BE LIABLE FOR ANY ACTUAL, DIRECT, SPECIAL, COLLATERAL, INDIRECT, PUNITIVE, INCIDENTAL, CONSEQUENTIAL OR EXEMPLARY DAMAGES IN CONNECTION WITH OR ARISING OUT OF TI RESOURCES OR USE THEREOF, AND REGARDLESS OF WHETHER TI HAS BEEN ADVISED OF THE POSSIBILITY OF SUCH DAMAGES.

Unless TI has explicitly designated an individual product as meeting the requirements of a particular industry standard (e.g., ISO/TS 16949 and ISO 26262), TI is not responsible for any failure to meet such industry standard requirements.

Where TI specifically promotes products as facilitating functional safety or as compliant with industry functional safety standards, such products are intended to help enable customers to design and create their own applications that meet applicable functional safety standards and requirements. Using products in an application does not by itself establish any safety features in the application. Designers must ensure compliance with safety-related requirements and standards applicable to their applications. Designer may not use any TI products in life-critical medical equipment unless authorized officers of the parties have executed a special contract specifically governing such use. Life-critical medical equipment is medical equipment where failure of such equipment would cause serious bodily injury or death (e.g., life support, pacemakers, defibrillators, heart pumps, neurostimulators, and implantables). Such equipment includes, without limitation, all medical devices identified by the U.S. Food and Drug Administration as Class III devices and equivalent classifications outside the U.S.

TI may expressly designate certain products as completing a particular qualification (e.g., Q100, Military Grade, or Enhanced Product). Designers agree that it has the necessary expertise to select the product with the appropriate qualification designation for their applications and that proper product selection is at Designers' own risk. Designers are solely responsible for compliance with all legal and regulatory requirements in connection with such selection.

Designer will fully indemnify TI and its representatives against any damages, costs, losses, and/or liabilities arising out of Designer's non-compliance with the terms and provisions of this Notice.