

COOLING FAN

San Ace



2016

SANYO DENKI

Part Numbering System Not every combination of the following codes or characters is available. Contact us for an available combination.

9GV	12	12	J	1	01	1
Type name / frame material 109P / Plastics 109R / Plastics 9GA / Plastics 9S / Plastics 9GV / Plastics Aluminum 9GE / Aluminum 9G / Plastics 9A / Plastics 9SG / Aluminum 109E / Aluminum 9EC / Aluminum 9GX / Plastics 9GAX / Plastics	Frame size 36 : 36×36mm 03 : 38×38mm 04 : 40×40mm 05 : 52×52mm 06 : 60×60mm 08 : 80×80mm 09 : 92×92mm 12 : 120×120mm 13 : 127×127mm 14 : 140×140mm 15 : 150×150mm 17 : ϕ 172mm 47 : ϕ 172mm×147mm (sidecut) 57 : ϕ 172mm×150mm (sidecut) 20 : ϕ 200mm	Voltage 05 : 5V 12 : 12V 24 : 24V 48 : 48V etc	Speed code A, B, C, D, E, F, G, H, J, K, L, M, S, W etc	Frame thickness 0 : 70mm 1 : 38mm thick 2 : 32mm thick 3 : 28mm thick 4 : 25mm thick 5 : 50mm thick 51mm thick 6 : 20mm thick 7 : 15mm thick 9 : 10mm thick	Sensor specifications 01 or 001 : With a pulse sensor 02 or 002 : Without a sensor D01 or D001 : With a lock sensor	Frame form Nil : Plastics frame: Ribbed frame Aluminum frame: Ribless frame 1 : Plastics frame: Ribless frame 3 : 40×40×28mm for 1U applications Plastics frame: Ribbed frame

Fans with PWM control function

Example :

9GV	12	12	P	4	G	01	
Type name / frame material 9GV / Plastics Aluminum	Frame size 12 : 120×120mm	Voltage 12 : 12V	PWM control function	Frame thickness	Speed code	Individual customer's spec 2 to 4 digits	Frame form Nil : Plastics frame: Ribbed frame Aluminum frame: Ribless frame

The Meaning of the Specifications

DC Fan											DC	
Model No.	① Rated Voltage [V]	② Operating Voltage Range [V]	③ Rated Current [A]	④ Rated Input [W]	⑤ Rated Speed [min ⁻¹]	⑥ Max. Airflow [m ³ /min] [CFM]		⑦ Max. Static Pressure [Pa] [inchH ₂ O]		⑧ SPL [dB(A)]	⑨ Operating Temperature [°C]	⑩ Expected Life [h]
9G0812G101	12	7 to 13.8	1.1	13.2	6,300	2.55	90	211	0.847	51	-20 to +70	40,000

- ①Rated Voltage This is the necessary voltage to drive the fan. 12VDC, 24VDC and 48VDC are available.
- ②Operating Voltage Range The voltage range over which fan operation is guaranteed
- ③Rated Current The current value during the fan's rated operation without load
- ④Rated Input The input value during the fan's rated operation without load
- ⑤Rated Speed The rotating speed during the fan's rated operation without load
- ⑥Max. Airflow The maximum air volume that the fan can output during rated operation (according to the company's dual-chamber device).
The volume of air generated by the fan in a given time period
- ⑦Max. Static Pressure The maximum static pressure value that the fan can output during rated operation (according to the company's dual-chamber device). The static pressure is the fan's force to propel air by overcoming the resistance of the device that uses the fan when it propels air.
- ⑧SPL "SPL" is Sound Pressure Level. The noise level during the fan's rated operation.
Please refer to the technical material section for the method used to measure the noise level.
- ⑨Operating Temperature Range The temperature range over which fan operation is guaranteed (Non- condensing)
- ⑩Expected Life The fan's expected operating life when the fan operates continuously at the rated voltage at a temperature of 60°C and at relative humidity of 90%.
Please refer to the technical material section for the expected operating life.

DC Fan Common Specifications

- Material** Frame,Impeller:Plastics / Frame:Aluminum,Impeller:Plastics
* For details, refer to the appropriate page.
- Expected Life** Varies for each model (L10:Survival rate:90% at 60°C ,rated voltage, and continuously run in a free air state)
* Splash proof fan: Varies for each model (Indoor, L10:Survival rate:90% at 60°C ,rated voltage, and continuously run in a free air state)
- Motor Protection** Burnout protection at locked rotor condition and Reverse polarity protection
- Dielectric Strength** AC50/60Hz 500VAC 1minute(between lead conductor and frame)
- Insulation Resistance** 10M Ω or more at 500VDC megger (between lead conductor and frame)
- Sound Pressure Level(SPL)** Expressed as the value at 1m from air inlet side
- Storage Temperature** -20°C to +70°C / -30°C to +70°C (Varies depending on models. Non-condensing)
- Lead Wire** For details, refer to the appropriate page.

Overheating protection function

Protection Functions:
If the fan blades are restricted, an overcurrent occurs and leads to a rise in the fan coil temperature. This can result in reduced performance, damage, or a fire. To prevent this from occurring, SANYO DENKI's fans incorporate an overheating protection function. Refer to the catalog for the types of protection functions.

Burnout protection function at locked rotor condition

- Current cutoff system
If the fan blades are restricted, the coil current is cut off at regular cycles to prevent overheating of the coil. When the hindrance is removed, the fan restarts automatically.

Reverse polarity protection function

No problem about fan even if positive & negative lead are connected in reverse.
However, when wiring fans with sensors or PWM speed control function, connecting positive and negative leads in reverse may damage the fans.

Recommended connectors for DC fans

DC

Manufacturer	2 pins Housing model number	3 pins Housing model number	4 pins Housing model number	Contact model number
MOLEX	22-01-1022:P/N 5051-02	22-01-1032:P/N 5051-03 22-01-3037:P/N 2695-03RP	22-01-1042:P/N 5051-04	08-70-0064:P/N 5159T
				08-70-0048:P/N 5159PBT
				39-00-0372:P/N 2759T
	43025-0200	—	43025-0400	43030-0001
	51191-0200	51191-0300	51191-0400	43030-0002
50-37-5023:P/N 5264-02	50-37-5033:P/N 5264-03	50-37-5043:P/N 5264-04	43030-0003	
51191-0200	51191-0300	51191-0400	50802-9001	
			08-70-1039:P/N 5263PBT	
50-37-5023:P/N 5264-02	50-37-5033:P/N 5264-03	50-37-5043:P/N 5264-04	39-00-0059:P/N 5556PBT	
39-01-2020:P/N 5557-02R	—	39-01-2040:P/N 5557-04R	39-00-0038:P/N 5556T	
Tyco Electronics	171822-2	171822-3	171822-4	170262-1
	179228-2	179228-3	179228-4	179227-1
Hirose	DF1B-2EP-2.5RC	DF1B-3EP-2.5RC	—	DF1B-2428PCF
	DF3-2EP-2C	DF3-3EP-2C	DF3-4EP-2C	DF3-EP2428PCF
	DF3AA-2EP-2C	DF3AA-3EP-2C	DF3AA-4EP-2C	
Japan Solderless Terminals	EHR-2	EHR-3	EHR-4	SEH-001T-P0.6
	SMP-02V-BC	SMP-03V-BC	SMP-04V-BC	SHF-001T-0.8BS
	SMP-02V-NC	SMP-03V-NC	—	
	H2P-SHF-AA	H3P-SHF-AA	—	
	PHR-2	PHR-3	PHR-4	SPH-002T-P0.5S
	XAP-02V-1	XAP-03V-1	XAP-04V-1	SXA-001T-P0.6
	XMP-02V	XMP-03V	—	
	XHP-2	XHP-3	XHP-4	SXH-001GU-P0.6
	SMR-02V-B	SMR-03V-B	SMR-04V-B	SXH-001T-P0.6
	SMR-02V-N	SMR-03V-N	SMR-04V-N	SYM-001T-P0.6

Recommended tubes and cable ties for DC fan

DC

	Manufacturer	Representative model numbers	Specifications	UL File No.
PVC tube	YAMAICHI CHEMICAL	YET-300H	105°C 300V VW-1	E55011
	IWASE KAGAKU KOGYO	AH-3		E56036
Thermal contraction tube	SUMITOMO ELECTRIC	SUMITUBE® F2 (Z)	125°C 600V VW-1	E48762
	SUMI-PAC	SUMITUBE® F32		
Cable tie	THOMAS & BETTS	TY-23M	UL94V-2	E49405
	PANDUIT	BT1M		E56854
	HellermannTyton	T18R		E64962

Note : The specifications in this table are for reference purposes only. When selecting, please check catalogs of each brand.

Overview and Characteristics of Fan

Overview DC AC

A cooling fan is widely used to extend life of your system by cooling off heat of the system that many electrical components are mounted in a very high density and dissipating heat. Since we SANYO DENKI developed "San Ace" which is the first AC fan in Japan in 1965, we have increased fan motor lineup until now meeting customer's needs rapidly based on our tremendous career. We SANYO DENKI will continue to develop new fans with high airflow, low noise, low vibration, and energy-saving design.

Characteristics DC AC

We can roughly divide fan into two types which are AC and DC.

AC Fans

SANYO DENKI succeeded in the mass-production of AC fans in 1965. SANYO DENKI was the first Japanese manufacturer to have succeeded at this.

- High performance
- High reliability
- Safety

DC Fans

SANYO DENKI succeeded in the mass-production of DC fans in 1982.

- High performance
- Low power consumption
- Low vibration
- Low leakage of flux
- High reliability

SANYO DENKI currently has a wider variety of products like Long Life Fan, CPU cooler, Splash Proof Fan, and Oil Proof Fan etc to meet all customer needs.

Guideline in Selecting a Fan

How to select an appropriate fan DC AC

The following example is a guideline regarding how to select an appropriate fan for cooling your system

1. Determining of your system specifications and conditions

Determine the temperature rise inside your system and obtain the total heating value inside your system on the basis of its inputs and outputs.

Example

- V : Total heating value of your system (W) =100 (W)
- ΔT : Inside temperature rise (K) =15 (K)

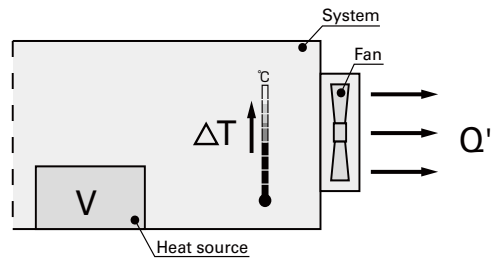

2. Calculating the required airflow for cooling

After the equipment specifications and conditions of your system have been determined, calculate required airflow to meet the conditions. (Note that the formula shown below only applies when the heat radiation is performed only by cooling air from the fan.)

Example

Q': Motion airflow (m³/min)

$$Q' = \frac{V}{20\Delta T} = \frac{100 (W)}{20 \times 15 (K)} \approx 0.33 (m^3/min)$$

3. Selecting the fan

After the motion airflow has been calculated, select an appropriate fan motor based on the value. The motion airflow when the fan motor is actually mounted in your system can be obtained using the airflow-static pressure characteristics curve and system impedance. However, the system impedance cannot be measured without a measuring equipment, so fan with 1.5 to 2 times higher airflow than the actual max airflow should be selected (operating airflow is one-third to two-thirds of maximum airflow).

Example

Q: Maximum airflow (m³/min)

$$Q' = Q \times 2/3$$

$$Q = Q' \times 3/2 = 0.33 \times 3/2 \approx 0.5 (m^3/min)$$

Next, In case that you select a fan having an airflow of 0.5 (m³/min) or more and a appropriate size for the space inside your system.

For example, If you need a fan of 60mm square, 25mm thickness and 12V, you should select is 109R0612H402 (maximum airflow = 0.53m³/min).

4. Confirming the selected fan

Calculate the temperature rise inside your sysetem when your sysetem having 100 (W) of total heating value is forcefully cooled down by a 109R0612H402 fan.

Example

$$Q' = Q \times 2/3 = 0.53 \times 2/3 \approx 0.353 (m^3/min)$$

$$\Delta T = V / 20Q' = 100 (W) / 20 \times 0.353 (m^3/min) \approx 14.2 (K)$$

From the above, the temperature rise inside your system is calculated as 14.2 (K).

Since the value obtained from the above equation is only a rough target, final fan selection should be based on your actual installation test.

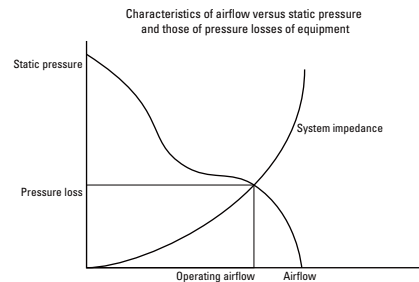

Characteristics Calculation Method and Description

Reliability and expected life

DC AC

A cooling fan generally cools itself as well. The temperature rise of the motor is relatively low and the temperature rise of the grease in the bearings is also low, so expected life is longer than general some other motors. Since the service life of bearings is a theoretical value that applies when they are ideally lubricated, the life of lubricant can be regarded as expected life of the fan. DC fan consumes less power and its temperature rise of bearing is very low. When the measurement conditions are: L10 (the remaining product life in the lifespan test is 90%), with an atmospheric temperature of 60 degrees, at the rated voltage, and continuously run in a free air state. The table below indicates the relationship between ambient temperature and expected life estimated on the basis of our life tests and same other tests conducted by SANYO DENKI.

Expected life of DC Fans

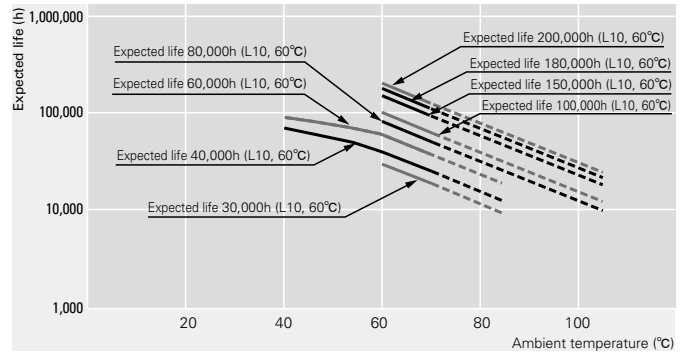

Rated voltage, continuously run in a free air state, survival rate of 90%

Expected life of AC Fans

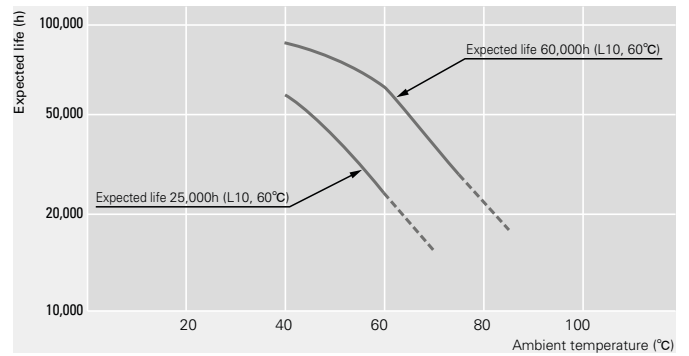

Rated voltage, continuously run in a free air state, survival rate of 90%

Noise characteristics

DC AC

Noise is average value that measured at 1 meter away from air intake side of fan that is suspended on special frame in anechoic chamber (as per JIS B 8346).

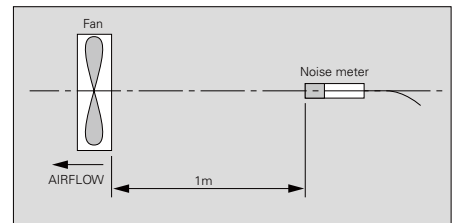

Acoustic radio wave anechoic chamber

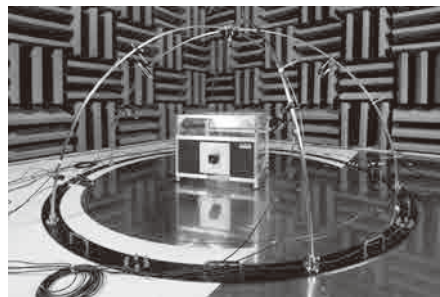

Noise characteristic measurement equipment

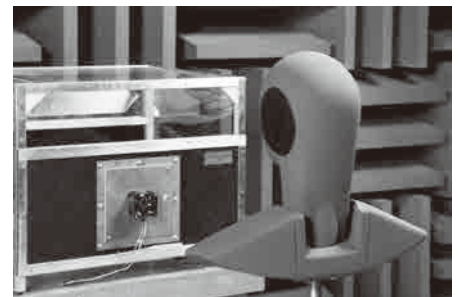

It is very difficult to measure airflow and static pressure. In fact, the performance curve may vary greatly according to the type of measuring equipment.

The commonly-used type of measuring equipment is a wind tunnel using a Pitot tube. SANYO DENKI uses a very precise method using double chamber equipped with many nozzles.

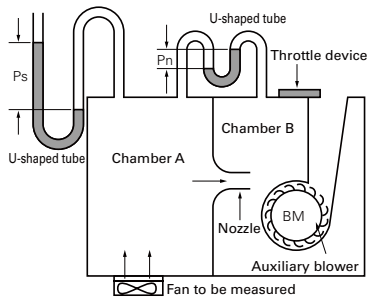

Double chamber measuring equipment

$$Q = 60A\bar{v} \text{ (A)}$$

where

Q = airflow (m³/min)

A = cross sectional area of nozzle = $\frac{\pi}{4}D^2$ (m²)

D = nozzle diameter

\bar{v} = average airflow velocity of nozzle = $\sqrt{2g \frac{P_n}{\gamma}}$ (m/sec)

γ : Air specific gravity (kg/m³)

($\gamma = 1.2 \text{ kg/m}^3$ at 20°C, 1 atmospheric pressure)

g = acceleration of gravity = 9.8 (m/sec²)

P_n = differential pressure (mm H₂O)

P_s = static pressure (mm H₂O)

The measuring equipment using double chamber is method to be calculated from airflow goes through nozzle and differential pressure between pressure of inside of chamber (P_s) and atmospheric pressure by measuring differential pressure between air intake and exhaust of nozzle (P_n).

Conversion table

Static pressure

1mm H₂O=0.0394inch H₂O

1mm H₂O=9.8Pa (Pascal)

1inch H₂O=25.4mm H₂O

1Pa=0.102mm H₂O

1inch H₂O=249Pa

Airflow

1m³/min=35.31ft³/min (CFM)

1CFM=0.0283m³/min

1m³/min=16.67ℓ /sec

1CFM=0.472ℓ /sec

1ℓ /sec=0.06m³/min

UPS, inverter, rectifier, high-voltage power supply, etc.

Cautions for Use of a Cooling Fan in the Vicinity of a Power Switching Circuit (prevention of electrolytic corrosion)

If a fan is installed near a large-power or high-voltage switching circuit, the heavy electromagnetic noise resulting from electromagnetic induction in such circuits or the influence of high-frequency noise imposed through the power line of the fan may induce current through the shaft bearing of the fan. Such current may damage the oil film on the bearing and even the friction surface of the bearing. This adverse effect is known as "electrolytic corrosion of the fan." Electrolytic corrosion affects the smooth revolution of the fan and may reduce its service life. An audible symptom is unusual noise emitted from the fan. This adverse effect is often observed and may partly be explained by the practice of mounting high-density parts, which reduces the gap between the switching circuits and the fan and the use of higher switching frequencies apt to provoke induction. Data processing/communications devices that operate at low voltages are not liable to electrolytic corrosion since they generate less electromagnetic noise.

A Case of electrolytic corrosion DC AC

Fans without anti-corrosion features installed near components that generate electromagnetic noise, such as inverter controllers, are liable to experience electrolytic corrosion.

No.	Use	Period until the occurrence of unusual noise
1	Switching power supply	6 months to 2 years
2	UPS	6 months to 2 years
3	General-purpose inverter	1 to 1.5 years
4	Air cleaner	2 to 3 months
5	Inverter for LCDs	6 months

The curve shown in the graph below represents the relationship between the level of the electromagnetic noise induced by a fan and the distance from the fan to the noise source.

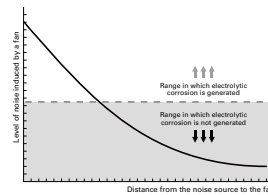

Occurrence of electrolytic corrosion Pattern 1

- (1)The fan gets charged with high-frequency electricity by high-frequency noise (electric field/magnetic field) generated in the switching circuit.
- (2)Because of high-frequency electricity charged in the fan, an electric current flows through the bearing of the fan.
- (3)The electric current breaks the oil membrane on the surface of the bearing and the bearing gets abraded (electrolytically corroded).
- (4)This symptom often occurs in equipment in which switching circuits are sped up and implemented in high density.
- (5)Countermeasure 1: To provide a shield plate^(Note 1) inside the fan (The plate should be such that does not interfere with airflow).
- (6)Countermeasure 2: To use a fan with ceramic bearings.

Occurrence of electrolytic corrosion Pattern 2

- (1)High-frequency electricity flows from the circuit board into the inside of the fan superimposed with the power line for the fan.
- (2)High-frequency electricity that has entered into the fan flows through the bearing.
- (3)Oil membrane on the surface of the bearing gets broken and the bearing gets abraded (electrolytically corroded).
- (4)Countermeasure 1: To remove high-frequency component between terminals "a" and "b", "a" and "e" and "b" and "e" of the power supply for the fan, or to insert a filter^(Note 2) into the power line for the fan.
- (5)Countermeasure 2: To use a fan with ceramic bearings
- (6)Cables should be twisted in order to decrease induction to the power line for the fan.

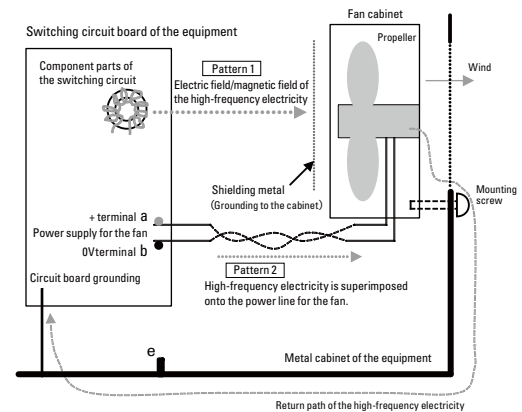

Note 1 : Shielding metal plate
As an electromagnetic shield metal, "EMC Guard" is available from our company. <http://www.sanyodenki.co.jp/product/newfan/indexf.html>
Certain shielding effect can be expected from mounting a general-purpose finger guard inside the fan. In each case, grounding to the cabinet is required.

Note 2 : Filter
Insert a common mode filter when the high-frequency electricity is superimposed on both lines "a" and "b" in the same phase and, if not, insert a normal mode filter.

Measures against electrolytic corrosion DC AC

- Relocate fans far from all electromagnetic noise sources.
- Attach an EMC guard to ordinary fans. This should have an effect on electromagnetic noise due to radiation.
- As a power supply, the fan is wired from a circuit for which noise is not superimposed.
- Against heavy electromagnetic noise (electromagnetic induction) and conductive noise from the power supply line for a fan, we recommend the use of an "Electrolytic corrosion proof fan" with ceramic bearing.

This cooling fan prevents electrolytic corrosion of bearings even under conditions where electromagnetic noise is generated. Electrolytic corrosion of ball bearings is prevented by using ceramic balls in ball bearings. The ceramic material is an insulating material. Manufacturable to meet specifications of all San Ace series fans.

Component Diagram

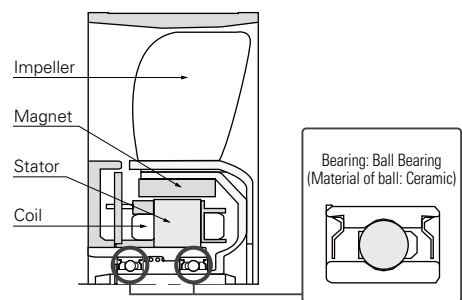

Caution

Electrolytic Corrosion Proof Fan has been designed to prevent the electrolytic corrosion of ball bearings in the fan, but this does not guarantee that the fan will operate normally under conditions where there is strong electromagnetic noise. Please be sure to fully evaluate the value of fan malfunction due to noise in advance.

Specifications for DC Fan Sensors

Pulse sensor (Tach output type) example DC

Pulse sensor outputs two pulse waves per revolution of fan, and it is good to detect fan speed. Pulse sensors can be incorporated in all kinds of DC fans.

* Noise from inside the fan or from external devices may effect sensor output.
 Contact us for more information.

The specifications listed below are for the 9G1212H101 model, and vary with the model number used. Please contact your point of sale for details.

Output circuit
 Open collector

Specifications

$V_{CE} = +30V$ MAX.
 (For a 48V-rated fan: $V_{CE} = +60V$ MAX.)
 $I_c = 10mA$ MAX. [$V_{OL} = V_{CE} (SAT) = 0.4V$ or less]

Inside of DC fan

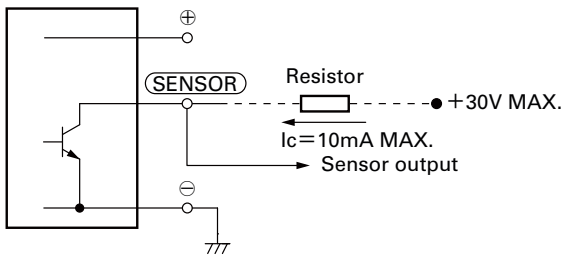

Output waveform (Need pull-up resistor)
 In case of steady running

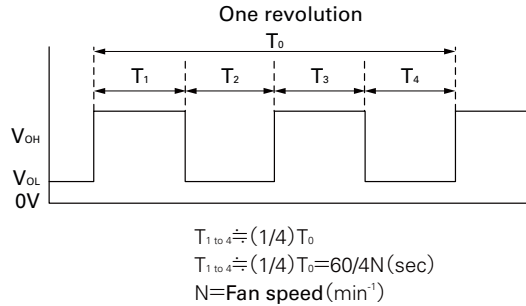

* If you want detailed specifications that apply when the rotor is locked, please contact SANYO DENKI.

Locked rotor sensor (rotation/lock detection type) example DC

Locked rotor sensor outputs fan status signals. It is good to check whether the fan is running or locked

- * Noise from inside the fan or from external devices may effect sensor output.
- * Regarding details of the reverse logic and specifications of lock sensor output signals, please contact SANYO DENKI.
- * Lock sensor can not be used in some models. Contact us for more information.

The specifications listed below are for the 9G1212H1D01 model, and vary with the model number used. Please contact your point of sale for details.

Output circuit
 Open collector

Specifications

$V_{CE} = +27.6V$ MAX.
 For a 48V fan $V_{CE} = +60V$ MAX.
 $I_c = 5mA$ MAX. [$V_{OL} = V_{CE} (SAT) = 0.6V$ or less]
 For a 48V fan: $V_{CE} (SAT) = 0.4V$ or less

Inside of DC fan

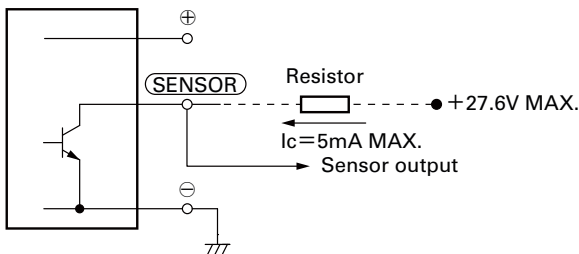

Output waveform (Need pull-up resistor)

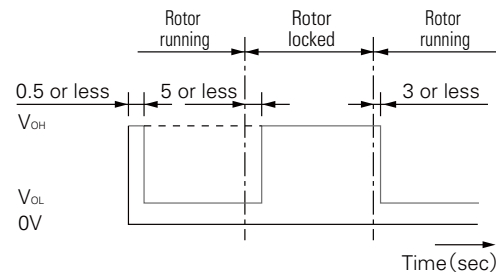

Note: The output is completely at V_{OL} with 0.5 seconds or less after power-up.

Low-speed sensor outputs a signal when fan speed goes down to trip point or less. It is good to detect cooling degradation of fan.

*Noise from inside the fan or from external devices may effect sensor output, please.

*If you want detailed specification and reverse signal output, please contact SANYO DENKI.

*Low-speed sensors can not be used in some models. Contact us for more information.

The specifications listed below are for the 9G1212H1H01 model, and vary with the model number used. Please contact your point of sale for details.

Output circuit

Open collector

Specifications

$V_{CE} = 27.6V \text{ MAX.}$

$I_c = 10mA \text{ MAX.}$ [$V_{OL} = V_{CE}(\text{SAT}) = 0.5V \text{ or less}$]

Sensor scheme

Example 1:

In case steady running

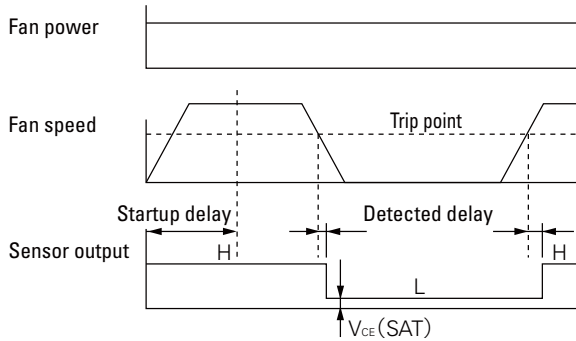

Inside of DC fan

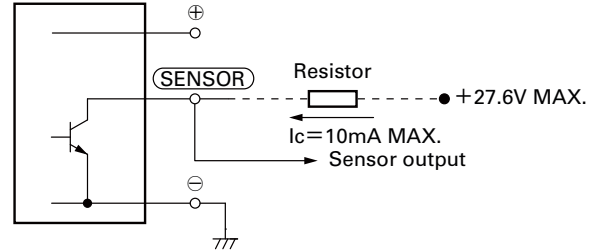

Example 2:

In case that the rotor is locked when the fan motor is turned on and released after the start-up delay time.

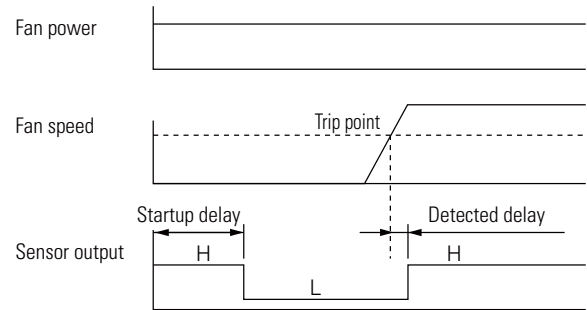

Specifications for PWM Control Function

The PWM control function is a function that externally controls the rotation speed of the fan by changing the duty of the input pulse signal between the control terminal and GND.

It regulates optimum airflow for efficient cooling when necessary, and is effective for lowering power consumption and reducing equipment noise level.

* Some models can not have PWM control function. Contact us for more information.

Typical standard model: 9G0812P1G04 DC

The details shown below are just one example. Specifications vary with each model number.

PWM Duty - Speed Characteristics

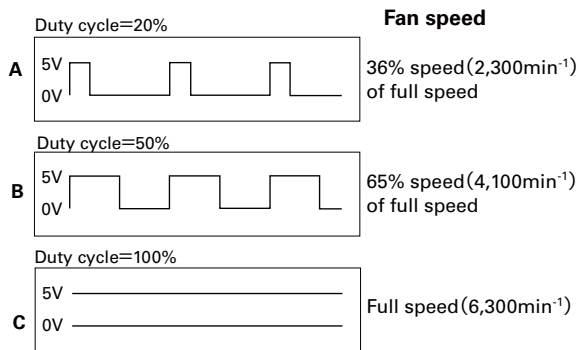
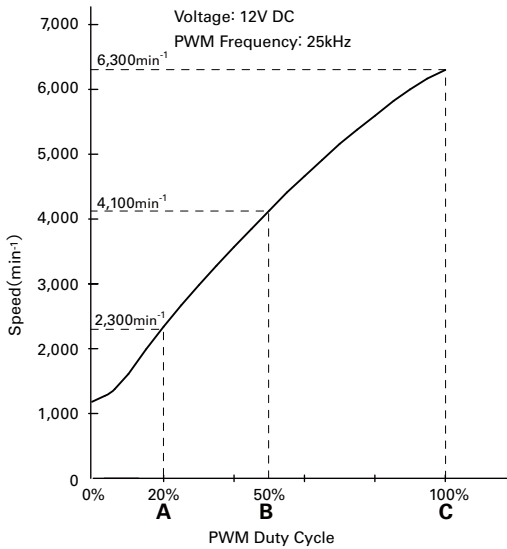

PWM Input Signal

Input Signal Wave Form

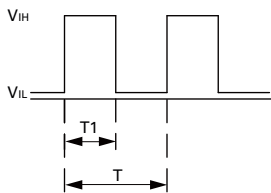

$V_{IH} = 4.75V \text{ to } 5.25V$
 $V_{IL} = 0V \text{ to } 0.4V$
 $PWM \text{ Duty Cycle}(\%) = \frac{T_1}{T} \times 100$
 $PWM \text{ Frequency } 25 \text{ (kHz)} = \frac{1}{T}$

Source Current (I source) : 1mA Max. at control voltage 0V
 Sink Current (I sink) : 1mA Max. at control voltage 5.25V
 Control Terminal Voltage : 5.25V Max. (When control terminal is opened)
 When the control lead wire is open, the fan speed is the same as the one at a PWM duty cycle of 100%.
 Either TTL input, open collector or open drain can be used for PWM control input signal.

The rotation speed characteristics for the PWM duty may change when inputting different voltages and frequencies or using the open collector and the drain input. Please contact us as necessary.

Example of Connection Schematic

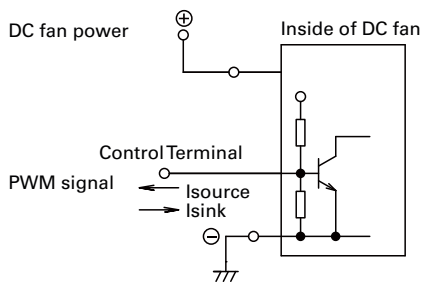

Source Current (I source) : 1mA Max. at control voltage 0V
 Sink Current (I sink) : 1mA Max. at control voltage 5.25V
 Control Terminal Voltage : 5.25V Max. (When control terminal is opened)

Specifications for AC Fan Sensor

ACDC fan sensor specifications differ from those below. Please refer to each product page.

Specifications of sensor circuit

AC

	5V (ITEM-20*)	12V (ITEM-30*)
Example of model.no	109S405UL	
System	Speed detection, Auto-restart, Open collector	
Power supply	DC5V±10% At 5V, 6mA	DC12V±20% At 12V, 10mA
Recommend sensor circuit output	At Vp=5V, I=100mA MAX.	At Vp=12V, I=200mA MAX.
Trip point	Standard speed : 1,700min ⁻¹ ±10% Low speed : 850min ⁻¹ ±10%	
Response speed	Standard speed : Startup delay 18sec Low speed : Startup delay 36sec	Detection delay 1sec Detection delay 2sec
Insulation resistance	10 MΩ MIN. at a 500V DC megger (Note)	
Dielectric strength	50/60 Hz, 1,000V AC, 1 minute (Note)	
Ambient conditions	Temperature: -10 to +60°C, humidity: 90%RH MAX. (at 40°C)	



*[ITEM-20] and [ITEM-30] are printed on the fan nameplate.

Note: Between one end that all sensor leads consisting of brown, yellow and black are tied together and the G terminal or power terminal of the fan.

Sensor scheme

Example 1: When the AC power for the fan and the DC power for the sensor are turned on at the same time

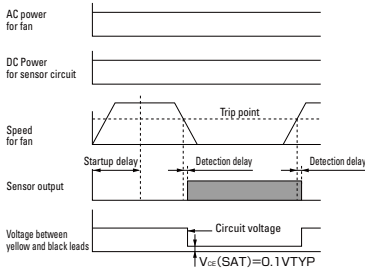

Example 2: When the AC power for the fan is turned on first, then the DC power for sensor is powered on

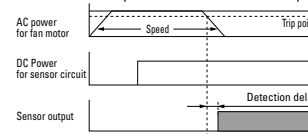

Example 3: When the DC power for sensor is first powered on, then the AC power for the fan is turned on

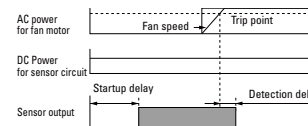

Sensor output circuit

5V (ITEM-20*)

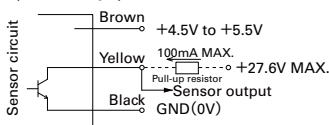

12V (ITEM-30*)

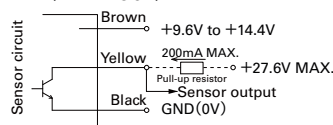

GND (Black) should be shared in case that power supply for sensor circuit (Brown) and that for sensor pull-up (Yellow) are separated.

Operating Precautions DC AC

Temperature conditions

Operating temperature: Refer to the specifications table for each model.

Storage temperature: -20°C to $+70^{\circ}\text{C}$ / -30°C to $+70^{\circ}\text{C}$ (Varies for each model / Non condensing)

* Rapid change in temperature may cause condensation. Prevent condensation when storing. Condensation may affect lubrication performance and insulation.

Power specifications

For the specification of rated voltage and voltage range, please check the catalog or drawing for the model number.

Use of voltage exceeding the specified range may lead to performance degradation, device failure, or fire hazards. Do not apply voltage that exceeds specifications to the fan.

An electronic circuit is used for the DC fan. For power supply, use power with ripple less than 5% with low line noise and surge to prevent electronic circuit trouble.

Handling precautions

The fan motor is equipped with a precision ball bearing. Therefore, please handle the motors carefully in order not to shock the bearings.

Installation tips

There are no limitations on the installation direction of fans or blowers. Fans have symbols on the fan indicating the airflow direction and blade rotation direction. When installing, use these symbols to check the airflow direction.

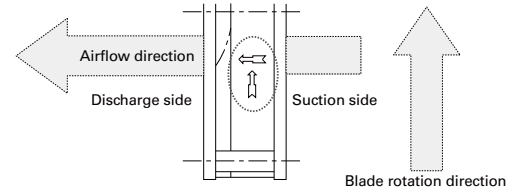

Symbols indicating the fan airflow direction and blade rotation direction

Recommended screw torque

This shows the recommended values for the screw torque when installing the fans. If the tightening torque is higher than the recommended values, the fan can be deformed or damaged.

Use care when tightening. Also, be sure to always use a fan with a ribbed structure when securing by screws with both flanges.

DC fan

Fan mounting hole diameter [mm]	Nominal screw diameter	Recommended screw torque
$\phi 3.5$	M3	0.44N·m MAX.
$\phi 4.3, \phi 4.5$	M4	0.78N·m MAX.
$\phi 4.3, \phi 4.5$	M4	0.98N·m MAX. ($\phi 172\text{mm} \times 51\text{mm}$, $\phi 172\text{mm} \times 150\text{mm} \times 51\text{mm}$, $\phi 200 \times 70\text{mm}$)

AC fan

Fan mounting hole diameter [mm]	Nominal screw diameter	Recommended screw torque
$\phi 3.5, \phi 3.7$	M3	0.44N·m MAX.
$\phi 4.3$	M4	0.58N·m MAX. (120mm×120mm MAX.)
$\phi 4.3$	M4	0.78N·m MAX. (ACDC fan, $\phi 172\text{mm}$)
$\phi 5.5$	M4, M5	0.78N·m MAX. (160mm×160mm)

Comparison of ribbed and ribless structures

Regarding plastic frame, we have a option ribbed and ribless about mounting. Please use preferred type up to your application. Please use ribbed fan in case that you hook fan up clamping either side fan mounting hole target. (According to the model, only models with or without ribs are available.)

*Use a fan with a rib structure when securing by screws with both flanges.

· When securing screws to ribless plastic frame models, use a flange to secure on one side.

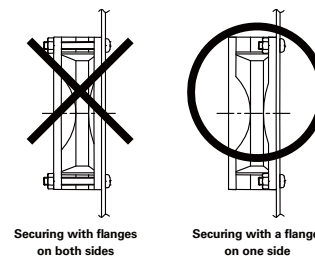
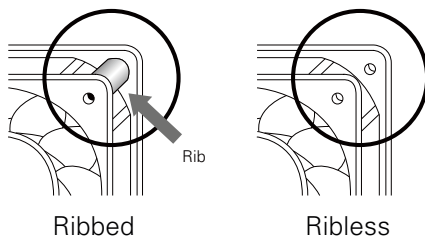

Fan Mounting Using Self-tapping Screw DC

Installing self-tapping screws into the plastic frame of the fan may split or deform it.

If using self-tapping screws, use screws that are recommended by our company, and refer to our recommended tightening torques and recommended pilot hole shapes. Pay close attention to the operating precautions and fully understand your equipment before you use it.

Recommended screw torques

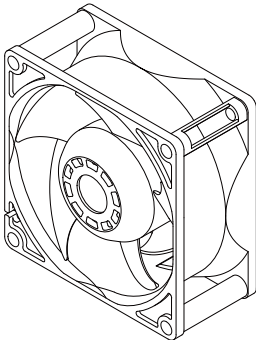

Fig. A: Ribbed fan

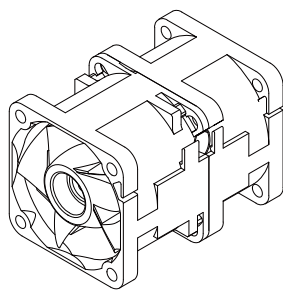

Fig. B: Counter rotating fan

	Recommended screw torque [N·m]	Fan mounting hole diameter [mm]
Ribbed fan (Fig. A)	0.8 Max.	φ3.5. φ4.3. φ4.5
Counter rotating fan (Fig. B)	0.6 Max.	

Do not use self-tapping screws in the following cases:

- For ribless fans (except for counter rotating fans)
- When mounting finger guards on fans

Using self-tapping screws could deform or split the frame. Please use regular screws.

Recommended pilot hole shape

[For nominal diameter 4mm]

Self-tapping screw model No.
SY-NS020412P11

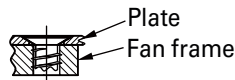
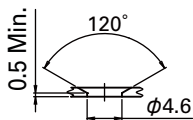

Minimum mounting plate thickness: T=1.2mm

Self-tapping screw model No.
SY-NS010412P11

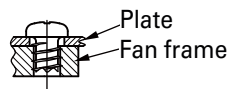
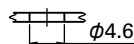

[For nominal diameters of 4.8mm and 5mm]

Self-tapping screw model No.
SY-NS024812P15
SY-NS020512P15

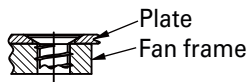
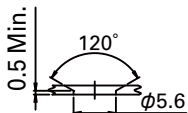

Minimum mounting plate thickness: T=1.2mm

Self-tapping screw model No.
SY-NS014812P15
SY-NS010512P15

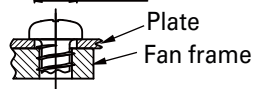
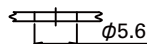

Recommended self-tapping screws

· Material: Steel

· Plating: Trivalent chromating plating

unit : mm

Fan mounting hole diameter	Self-tapping screw model No.	Nominal screw diameter	Length [L]	Head shape	Flat-head/pan-head dimensions		
					Head diameter [D]	Height of head [H]	Cross recess No.
φ3.5	SY-NS020412P11	4	12	Flat	6.2	1.1 Max.	2
	SY-NS010412P11	4	12	Pan	5.5	2.0	2
φ4.3	SY-NS024812P15	4.8	12	Flat	6.8	1.2 Max.	2
	SY-NS014812P15	4.8	12	Pan	7.0	2.6	2
φ4.5	SY-NS020512P15	5	12	Flat	6.8	1.2 Max.	2
	SY-NS010512P15	5	12	Pan	7.0	2.6	2

Head shape: Flat

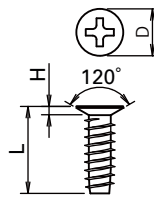

Head shape: Pan

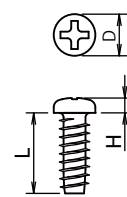

Operating precautions

- Place the self-tapping screw so that it is vertical and centered with the frame mounting hole (Fig. A) and then screw it in. The self-tapping screw could deform or split the frame if you screw it into the frame when the screw is not vertical.
- Screw in the self-tapping screw with the center of the mounting hole on the fan and the center of the pilot hole on the mounting plate aligned (Fig. B). Misaligned holes could lead to the frame being deformed or split.

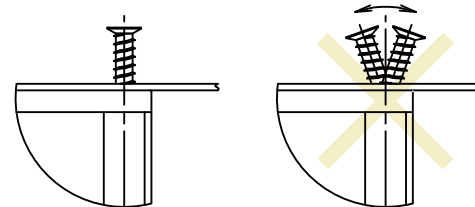

Vertically placed screw

Inclined screw

Fig. A

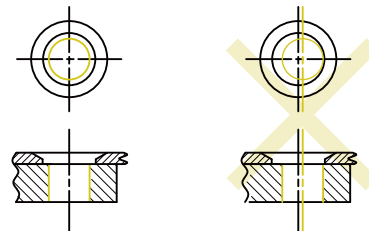

Aligned and centered holes

Misaligned holes

Fig. B

- Tightening the screw beyond the recommended screw torque could deform or split the frame.
- With flat-head screws, failure to use the recommended pilot hole shape will cause interference between the flat-head screw and fan frame which could split the frame.

Recommended screw manufacturer

To purchase the screws, please contact the screw manufacturer directly.

SAIMA CORPORATION

2-9-17 Tsujido Fujisawa Kanagawa 251-0047 JAPAN

TEL:+81-466-36-3656 FAX:+81-466-36-0009

<http://www.saima.co.jp/English/>

Index by Model No./Safety Standards List - DC Fans DC

Models listed in the main section of this catalog	List of models (models not listed in the main section of this catalog are options. Standards for optional model numbers may differ from the certified standards listed at right. Contact us for details of models with "-" model numbers.)				Frame Size	Rib	Standard (certification status is for the models listed in this catalog, and standards for optional model numbers may differ.)			page
	Without sensor	With pulse sensor	With lock sensor	With PWM control function and pulse sensor			UL (cUL)	CSA (cUL)	TÜV	
	109BC12FC7-1	109BC12FA7-1	109BC12FC7-1	109BC12FD7-1			—	52mm×15mm	—	
109BC12GC7-1	109BC12GA7-1	109BC12GC7-1	109BC12GD7-1	—	52mm×15mm	—	✓	✓	✓	393
109BC12HC7-1	109BC12HA7-1	109BC12HC7-1	109BC12HD7-1	—	52mm×15mm	—	✓	✓	✓	393
109BC12MC7-1	109BC12MA7-1	109BC12MC7-1	109BC12MD7-1	—	52mm×15mm	—	✓	✓	✓	393
109BC24FC7-1	109BC24FA7-1	109BC24FC7-1	109BC24FD7-1	—	52mm×15mm	—	✓	✓	✓	393
109BC24GC7-1	109BC24GA7-1	109BC24GC7-1	109BC24GD7-1	—	52mm×15mm	—	✓	✓	✓	393
109BC24HC7-1	109BC24HA7-1	109BC24HC7-1	109BC24HD7-1	—	52mm×15mm	—	✓	✓	✓	393
109BD12FC2	109BD12FA2	109BD12FC2	109BD12FD2	—	76mm×30mm	—	✓	✓	✓	397
109BD12HC2	109BD12HA2	109BD12HC2	109BD12HD2	109BD12P2H01	76mm×30mm	—	✓	✓	✓	397
109BD12MC2	109BD12MA2	109BD12MC2	109BD12MD2	—	76mm×30mm	—	✓	✓	✓	397
109BD24FC2	109BD24FA2	109BD24FC2	109BD24FD2	—	76mm×30mm	—	✓	✓	✓	397
109BD24HC2	109BD24HA2	109BD24HC2	109BD24HD2	—	76mm×30mm	—	✓	✓	✓	397
109BD24MC2	109BD24MA2	109BD24MC2	109BD24MD2	—	76mm×30mm	—	✓	✓	✓	397
109BG12HC1	109BG12HA1	109BG12HC1	109BG12HD1	—	160mm×40mm	—	✓	✓	✓	410
109BG12MC1	109BG12MA1	109BG12MC1	109BG12MD1	—	160mm×40mm	—	✓	✓	✓	410
109BG24HC1	109BG24HA1	109BG24HC1	109BG24HD1	—	160mm×40mm	—	✓	✓	✓	410
109BG24MC1	109BG24MA1	109BG24MC1	109BG24MD1	—	160mm×40mm	—	✓	✓	✓	410
109BJ12HC2	109BJ12HA2	109BJ12HC2	109BJ12HD2	—	127mm×32mm	—	✓	✓	✓	409
109BJ12MC2	109BJ12MA2	109BJ12MC2	109BJ12MD2	—	127mm×32mm	—	✓	✓	✓	409
109BJ24HC2	109BJ24HA2	109BJ24HC2	109BJ24HD2	—	127mm×32mm	—	✓	✓	✓	409
109BJ24MC2	109BJ24MA2	109BJ24MC2	109BJ24MD2	—	127mm×32mm	—	✓	✓	✓	409
109BM12GC2-1	109BM12GA2-1	109BM12GC2-1	109BM12GD2-1	—	97mm×33mm	—	✓	✓	✓	399
109BM12HC2-1	109BM12HA2-1	109BM12HC2-1	109BM12HD2-1	—	97mm×33mm	—	✓	✓	✓	399
109BM12MC2-1	109BM12MA2-1	109BM12MC2-1	109BM12MD2-1	109BM12P2M01	97mm×33mm	—	✓	✓	✓	399
109BM24GC2-1	109BM24GA2-1	109BM24GC2-1	109BM24GD2-1	—	97mm×33mm	—	✓	✓	✓	399
109BM24HC2-1	109BM24HA2-1	109BM24HC2-1	109BM24HD2-1	—	97mm×33mm	—	✓	✓	✓	399
109BM24MC2-1	109BM24MA2-1	109BM24MC2-1	109BM24MD2-1	—	97mm×33mm	—	✓	✓	✓	399
109E1312A101	109E1312A102	109E1312A101	109E1312A1D01	—	127×127×38mm	No	✓	✓	✓	181
109E1312S101	109E1312S102	109E1312S101	109E1312S1D01	—	127×127×38mm	No	✓	✓	✓	181
109E1324A101	109E1324A102	109E1324A101	109E1324A1D01	—	127×127×38mm	No	✓	✓	✓	181
109E1324G101	109E1324G102	109E1324G101	109E1324G1D01	—	127×127×38mm	No	✓	✓	✓	181
109E1324S101	109E1324S102	109E1324S101	109E1324S1D01	—	127×127×38mm	No	✓	✓	✓	181
109E1348A101	109E1348A102	109E1348A101	109E1348A1D01	—	127×127×38mm	No	✓	✓	✓	181
109E1348G101	109E1348G102	109E1348G101	109E1348G1D01	—	127×127×38mm	No	✓	✓	✓	181
109E1348S101	109E1348S102	109E1348S101	109E1348S1D01	—	127×127×38mm	No	✓	✓	✓	181
109E1712F501	109E1712F502	109E1712F501	109E1712F5D01	—	φ172mm×51mm	No	✓	✓	✓	201
109E1712H501	109E1712H502	109E1712H501	109E1712H5D01	—	φ172mm×51mm	No	✓	✓	✓	201
109E1712K501	109E1712K502	109E1712K501	—	—	φ172mm×51mm	No	✓	✓	✓	201
109E1712M501	109E1712M502	109E1712M501	—	—	φ172mm×51mm	No	✓	✓	✓	201
109E1712Y501	109E1712Y502	109E1712Y501	—	—	φ172mm×51mm	No	✓	✓	✓	201
109E1724C501	109E1724C502	109E1724C501	109E1724C5D01	9EH1724P5C01	φ172mm×51mm	No	✓	✓	✓	201
109E1724F501	109E1724F502	109E1724F501	109E1724F5D01	—	φ172mm×51mm	No	✓	✓	✓	201
109E1724H501	109E1724H502	109E1724H501	109E1724H5D01	—	φ172mm×51mm	No	✓	✓	✓	201
109E1724K501	109E1724K502	109E1724K501	109E1724K5D01	—	φ172mm×51mm	No	✓	✓	✓	201
109E1724M501	109E1724M502	109E1724M501	109E1724M5D01	—	φ172mm×51mm	No	✓	✓	✓	201
109E1748C501	109E1748C502	109E1748C501	—	—	φ172mm×51mm	No	✓	✓	✓	201
109E1748F501	109E1748F502	109E1748F501	—	—	φ172mm×51mm	No	✓	✓	✓	201
109E1748H501	109E1748H502	109E1748H501	109E1748H5D01	—	φ172mm×51mm	No	✓	✓	✓	201
109E1748K501	109E1748K502	109E1748K501	—	109E1748P5K03	φ172mm×51mm	No	✓	✓	✓	201
109E1748M501	109E1748M502	109E1748M501	—	—	φ172mm×51mm	No	✓	✓	✓	201
109E4712L401	109E4712L402	109E4712L401	109E4712L4D01	—	φ172mm×147mm×25mm	No	✓	✓	✓	191
109E4712M401	109E4712M402	109E4712M401	109E4712M4D01	—	φ172mm×147mm×25mm	No	✓	✓	✓	191
109E4724F401	109E4724F402	109E4724F401	109E4724F4D01	—	φ172mm×147mm×25mm	No	✓	✓	✓	191
109E4724H401	109E4724H402	109E4724H401	109E4724H4D01	109E4724P4H01	φ172mm×147mm×25mm	No	✓	✓	✓	191

Please contact your point of sale regarding low-speed sensors.

Standard name	Certification number
UL	E46810
CSA	172248

※TÜV certification numbers differ by model.

※The content of this catalog is current as of September 2016.

Please ask us about new products that we released after September 2016 if you want.

Models listed in the main section of this catalog	List of models (models not listed in the main section of this catalog are options. Standards for optional model numbers may differ from the certified standards listed at right. Contact us for details of models with "-" model numbers.)				Frame Size	Rib	Standard (certification status is for the models listed in this catalog, and standards for optional model numbers may differ.)			page
	Without sensor	With pulse sensor	With lock sensor	With PWM control function and pulse sensor			UL (cUL)	CSA (cUL)	TÜV	
							✓	✓	✓	
109E4724L401	109E4724L402	109E4724L401	109E4724L4D01	—	φ172mm×147mm×25mm	No	✓	✓	✓	191
109E4724M401	109E4724M402	109E4724M401	109E4724M4D01	—	φ172mm×147mm×25mm	No	✓	✓	✓	191
109E4748F401	109E4748F402	109E4748F401	109E4748F4D01	—	φ172mm×147mm×25mm	No	✓	✓	✓	191
109E4748H401	109E4748H402	109E4748H401	109E4748H4D01	—	φ172mm×147mm×25mm	No	✓	✓	✓	191
109E4748L401	109E4748L402	109E4748L401	109E4748L4D01	—	φ172mm×147mm×25mm	No	✓	✓	✓	191
109E4748M401	109E4748M402	109E4748M401	109E4748M4D01	—	φ172mm×147mm×25mm	No	✓	✓	✓	191
109E4748S401	109E4748S402	109E4748S401	109E4748S4D01	—	φ172mm×147mm×25mm	No	✓	✓	✓	191
109E5712F501	109E5712F502	109E5712F501	—	—	φ172mm×150mm×51mm	No	✓	✓	✓	199
109E5712H501	109E5712H502	109E5712H501	109E5712H5D01	—	φ172mm×150mm×51mm	No	✓	✓	✓	199
109E5712K501	109E5712K502	109E5712K501	109E5712K5D01	109E5712P5K04	φ172mm×150mm×51mm	No	✓	✓	✓	199
109E5712M501	109E5712M502	109E5712M501	109E5712M5D01	—	φ172mm×150mm×51mm	No	✓	✓	✓	199
109E5712Y501	109E5712Y502	109E5712Y501	—	—	φ172mm×150mm×51mm	No	✓	✓	✓	199
109E5724C501	109E5724C502	109E5724C501	109E5724C5D01	9EH5724P5C01	φ172mm×150mm×51mm	No	✓	✓	✓	199
109E5724F501	109E5724F502	109E5724F501	—	—	φ172mm×150mm×51mm	No	✓	✓	✓	199
109E5724H501	109E5724H502	109E5724H501	109E5724H5D01	—	φ172mm×150mm×51mm	No	✓	✓	✓	199
109E5724K501	109E5724K502	109E5724K501	109E5724K5D01	—	φ172mm×150mm×51mm	No	✓	✓	✓	199
109E5724M501	109E5724M502	109E5724M501	—	—	φ172mm×150mm×51mm	No	✓	✓	✓	199
109E5748C501	109E5748C502	109E5748C501	—	—	φ172mm×150mm×51mm	No	✓	✓	✓	199
109E5748F501	109E5748F502	109E5748F501	—	—	φ172mm×150mm×51mm	No	✓	✓	✓	199
109E5748H501	109E5748H502	109E5748H501	109E5748H5D01	—	φ172mm×150mm×51mm	No	✓	✓	✓	199
109E5748K501	109E5748K502	109E5748K501	—	—	φ172mm×150mm×51mm	No	✓	✓	✓	199
109E5748M501	109E5748M502	109E5748M501	—	—	φ172mm×150mm×51mm	No	✓	✓	✓	199
109L1412H101	109L1412H102	109L1412H101	109L1412H1D01	—	140×140×38mm	No	✓	✓	✓	349
109L1412M101	109L1412M102	109L1412M101	—	—	140×140×38mm	No	✓	✓	✓	349
109L1424H101	109L1424H102	109L1424H101	109L1424H1D01	—	140×140×38mm	No	✓	✓	✓	349
109L1424M101	109L1424M102	109L1424M101	109L1424M1D01	—	140×140×38mm	No	✓	✓	✓	349
109L1448H101	109L1448H102	109L1448H101	109L1448H1D01	—	140×140×38mm	No	✓	✓	✓	349
109L1448M101	109L1448M102	109L1448M101	109L1448M1D01	—	140×140×38mm	No	✓	✓	✓	349
109L1712H501	109L1712H502	109L1712H501	109L1712H5D01	—	φ172mm×51mm	No	✓	✓	✓	355
109L1712M501	109L1712M502	109L1712M501	109L1712M5D01	—	φ172mm×51mm	No	✓	✓	✓	355
109L1724H501	109L1724H502	109L1724H501	109L1724H5D01	—	φ172mm×51mm	No	✓	✓	✓	355
109L1724M501	109L1724M502	109L1724M501	109L1724M5D01	—	φ172mm×51mm	No	✓	✓	✓	355
109L1748H501	109L1748H502	109L1748H501	109L1748H5D01	—	φ172mm×51mm	No	✓	✓	✓	355
109L1748M501	109L1748M502	109L1748M501	109L1748M5D01	—	φ172mm×51mm	No	✓	✓	✓	355
109L5712H501	109L5712H502	109L5712H501	109L5712H5D01	—	φ172mm×150mm×51mm	No	✓	✓	✓	353
109L5712M501	109L5712M502	109L5712M501	109L5712M5D01	—	φ172mm×150mm×51mm	No	✓	✓	✓	353
109L5724H501	109L5724H502	109L5724H501	109L5724H5D01	—	φ172mm×150mm×51mm	No	✓	✓	✓	353
109L5724M501	109L5724M502	109L5724M501	109L5724M5D01	—	φ172mm×150mm×51mm	No	✓	✓	✓	353
109L5748H501	109L5748H502	109L5748H501	109L5748H5D01	—	φ172mm×150mm×51mm	No	✓	✓	✓	353
109L5748M501	109L5748M502	109L5748M501	109L5748M5D01	—	φ172mm×150mm×51mm	No	✓	✓	✓	353
109P0405F3013	109P0405F3023	109P0405F3013	109P0405F3D013	—	40×40×28mm	Yes	✓	✓	✓	43
109P0405F601	109P0405F602	109P0405F601	109P0405F6D01	—	40×40×20mm	Yes	✓	✓	✓	27
109P0405H3013	109P0405H3023	109P0405H3013	109P0405H3D013	—	40×40×28mm	Yes	✓	✓	✓	43
109P0405H601	109P0405H602	109P0405H601	109P0405H6D01	—	40×40×20mm	Yes	✓	✓	✓	27
109P0405H701	109P0405H702	109P0405H701	109P0405H7D01	—	40×40×15mm	Yes	✓	✓	✓	21
109P0405H901	109P0405H902	109P0405H901	109P0405H9D01	—	40×40×10mm	Yes	✓	✓	✓	17
109P0405J601	109P0405J602	109P0405J601	—	—	40×40×20mm	Yes	✓	✓	✓	27
109P0405M601	109P0405M602	109P0405M601	109P0405M6D01	—	40×40×20mm	Yes	✓	✓	✓	27
109P0405M701	109P0405M702	109P0405M701	109P0405M7D01	—	40×40×15mm	Yes	✓	✓	✓	21
109P0405M901	109P0405M902	109P0405M901	109P0405M9D01	—	40×40×10mm	Yes	✓	✓	✓	17
109P0412B3013	109P0412B3023	109P0412B3013	109P0412B3D013	109P0412P3B013	40×40×28mm	Yes	✓	✓	✓	43
109P0412D601	109P0412D602	109P0412D601	109P0412D6D01	—	40×40×20mm	Yes	✓	✓	✓	27
109P0412E601	109P0412E602	109P0412E601	109P0412E6D01	—	40×40×20mm	Yes	✓	✓	✓	27
109P0412F3013	109P0412F3023	109P0412F3013	109P0412F3D013	—	40×40×28mm	Yes	✓	✓	✓	43
109P0412F601	109P0412F602	109P0412F601	109P0412F6D01	—	40×40×20mm	Yes	✓	✓	✓	27
109P0412G3013	109P0412G3023	109P0412G3013	109P0412G3D013	—	40×40×28mm	Yes	✓	✓	✓	43
109P0412G601	109P0412G602	109P0412G601	109P0412G6D01	—	40×40×20mm	Yes	✓	✓	✓	27
109P0412H3013	109P0412H3023	109P0412H3013	109P0412H3D013	109P0412P3H013	40×40×28mm	Yes	✓	✓	✓	43
109P0412H601	109P0412H602	109P0412H601	109P0412H6D01	—	40×40×20mm	Yes	✓	✓	✓	27
109P0412H701	109P0412H702	109P0412H701	109P0412H7D01	—	40×40×15mm	Yes	✓	✓	✓	21
109P0412H901	109P0412H902	109P0412H901	109P0412H9D01	—	40×40×10mm	Yes	✓	✓	✓	17
109P0412J3013	109P0412J3023	109P0412J3013	109P0412J3D013	—	40×40×28mm	Yes	✓	✓	✓	43

Models listed in the main section of this catalog	List of models (models not listed in the main section of this catalog are options. Standards for optional model numbers may differ from the certified standards listed at right. Contact us for details of models with "-" model numbers.)				Frame Size	Rib	Standard (certification status is for the models listed in this catalog, and standards for optional model numbers may differ.)			page
	Without sensor	With pulse sensor	With lock sensor	With PWM control function and pulse sensor			UL	CSA	TÜV	
							(cUL)	(cUL)		
109P0412K3013	109P0412K3023	109P0412K3013	109P0412K3D013	9PH0412P3K033	40×40×28mm	Yes	✓	✓	✓	43
109P0412M3013	109P0412M3023	109P0412M3013	109P0412M3D013	—	40×40×28mm	Yes	✓	✓	✓	43
109P0412M601	109P0412M602	109P0412M601	109P0412M6D01	—	40×40×20mm	Yes	✓	✓	✓	27
109P0412M701	109P0412M702	109P0412M701	109P0412M7D01	—	40×40×15mm	Yes	✓	✓	✓	21
109P0412M901	109P0412M902	109P0412M901	109P0412M9D01	—	40×40×10mm	Yes	✓	✓	✓	17
109P0412R701	109P0412R702	109P0412R701	109P0412R7D01	—	40×40×15mm	Yes	✓	✓	✓	21
109P0412S701	109P0412S702	109P0412S701	109P0412S7D01	—	40×40×15mm	Yes	✓	✓	✓	21
109P0424B3013	109P0424B3023	109P0424B3013	109P0424B3D013	—	40×40×28mm	Yes	✓	✓	✓	43
109P0424B601	109P0424B602	109P0424B601	109P0424B6D01	—	40×40×20mm	Yes	✓	✓	✓	27
109P0424D601	109P0424D602	109P0424D601	109P0424D6D01	—	40×40×20mm	Yes	✓	✓	✓	27
109P0424F3013	109P0424F3023	109P0424F3013	109P0424F3D013	—	40×40×28mm	Yes	✓	✓	✓	43
109P0424F601	109P0424F602	109P0424F601	109P0424F6D01	—	40×40×20mm	Yes	✓	✓	✓	27
109P0424G3013	109P0424G3023	109P0424G3013	109P0424G3D013	—	40×40×28mm	Yes	✓	✓	✓	43
109P0424G601	109P0424G602	109P0424G601	109P0424G6D01	—	40×40×20mm	Yes	✓	✓	✓	27
109P0424H3013	109P0424H3023	109P0424H3013	109P0424H3D013	—	40×40×28mm	Yes	✓	✓	✓	43
109P0424H601	109P0424H602	109P0424H601	109P0424H6D01	—	40×40×20mm	Yes	✓	✓	✓	27
109P0424H701	109P0424H702	109P0424H701	109P0424H7D01	—	40×40×15mm	Yes	✓	✓	✓	21
109P0424J3013	109P0424J3023	109P0424J3013	109P0424J3D013	—	40×40×28mm	Yes	✓	✓	✓	43
109P0424R3013	109P0424R3023	109P0424R3013	—	—	40×40×28mm	Yes	—	—	—	43
109P0505M701	109P0505M702	109P0505M701	109P0505M7D01	—	52×52×15mm	Yes	✓	✓	✓	51
109P0512A701	109P0512A702	109P0512A701	109P0512A7D01	—	52×52×15mm	Yes	✓	✓	✓	51
109P0512H701	109P0512H702	109P0512H701	109P0512H7D01	—	52×52×15mm	Yes	✓	✓	✓	51
109P0512M701	109P0512M702	109P0512M701	109P0512M7D01	—	52×52×15mm	Yes	✓	✓	✓	51
109P0524A701	109P0524A702	109P0524A701	109P0524A7D01	—	52×52×15mm	Yes	✓	✓	✓	51
109P0524H701	109P0524H702	109P0524H701	109P0524H7D01	—	52×52×15mm	Yes	✓	✓	✓	51
109P0524M701	109P0524M702	109P0524M701	109P0524M7D01	—	52×52×15mm	Yes	✓	✓	✓	51
109P0605H701	109P0605H702	109P0605H701	109P0605H7D01	—	60×60×15mm	Yes	✓	✓	✓	59
109P0605M701	109P0605M702	109P0605M701	109P0605M7D01	—	60×60×15mm	Yes	✓	✓	✓	59
109P0612B701	109P0612B702	109P0612B701	109P0612B7D01	—	60×60×15mm	Yes	✓	✓	✓	59
109P0612H601	109P0612H602	109P0612H601	109P0612H6D01	—	60×60×20mm	Yes	✓	✓	✓	65
109P0612H701	109P0612H702	109P0612H701	109P0612H7D01	—	60×60×15mm	Yes	✓	✓	✓	59
109P0612K701	109P0612K702	109P0612K701	109P0612K7D01	—	60×60×15mm	Yes	✓	✓	✓	59
109P0612M601	109P0612M602	109P0612M601	109P0612M6D01	—	60×60×20mm	Yes	✓	✓	✓	65
109P0612M701	109P0612M702	109P0612M701	109P0612M7D01	—	60×60×15mm	Yes	✓	✓	✓	59
109P0612S701	109P0612S702	109P0612S701	109P0612S7D01	—	60×60×15mm	Yes	✓	✓	✓	59
109P0612V601	109P0612V602	109P0612V601	109P0612V6D01	—	60×60×20mm	Yes	✓	✓	✓	65
109P0624H601	109P0624H602	109P0624H601	109P0624H6D01	—	60×60×20mm	Yes	✓	✓	✓	65
109P0624H701	109P0624H702	109P0624H701	109P0624H7D01	—	60×60×15mm	Yes	✓	✓	✓	59
109P0624J701	109P0624J702	109P0624J701	109P0624J7D01	—	60×60×15mm	Yes	✓	✓	✓	59
109P0624M601	109P0624M602	109P0624M601	109P0624M6D01	—	60×60×20mm	Yes	✓	✓	✓	65
109P0624M701	109P0624M702	109P0624M701	109P0624M7D01	—	60×60×15mm	Yes	✓	✓	✓	59
109P0624S701	109P0624S702	109P0624S701	109P0624S7D01	—	60×60×15mm	Yes	✓	✓	✓	59
109P0624V601	109P0624V602	109P0624V601	109P0624V6D01	—	60×60×20mm	Yes	✓	✓	✓	65
109P0648H601	109P0648H602	109P0648H601	109P0648H6D01	—	60×60×20mm	Yes	✓	✓	✓	65
109P0812A201	109P0812A202	109P0812A201	109P0812A2D01	—	80×80×32mm	Yes	✓	✓	✓	121
109P0812A2011	109P0812A2021	109P0812A2011	109P0812A2D011	—	80×80×32mm	No	✓	✓	✓	121
109P0812C601	109P0812C602	109P0812C601	109P0812C6D01	—	80×80×20mm	Yes	—	—	—	99
109P0812H201	109P0812H202	109P0812H201	109P0812H2D01	—	80×80×32mm	Yes	✓	✓	✓	121
109P0812H2011	109P0812H2021	109P0812H2011	109P0812H2D011	—	80×80×32mm	No	✓	✓	✓	121
109P0812H601	109P0812H602	109P0812H601	109P0812H6D01	—	80×80×20mm	Yes	✓	✓	✓	99
109P0812H701	109P0812H702	109P0812H701	109P0812H7D01	—	80×80×15mm	Yes	✓	✓	✓	95
109P0812M201	109P0812M202	109P0812M201	109P0812M2D01	—	80×80×32mm	Yes	✓	✓	✓	121
109P0812M2011	109P0812M2021	109P0812M2011	109P0812M2D011	—	80×80×32mm	No	✓	✓	✓	121
109P0812M601	109P0812M602	109P0812M601	109P0812M6D01	—	80×80×20mm	Yes	✓	✓	✓	99
109P0812M701	109P0812M702	109P0812M701	109P0812M7D01	—	80×80×15mm	Yes	✓	✓	✓	95
109P0824A201	109P0824A202	109P0824A201	109P0824A2D01	—	80×80×32mm	Yes	✓	✓	✓	121
109P0824A2011	109P0824A2021	109P0824A2011	—	—	80×80×32mm	No	✓	✓	✓	121
109P0824H201	109P0824H202	109P0824H201	109P0824H2D01	—	80×80×32mm	Yes	✓	✓	✓	121
109P0824H2011	109P0824H2021	109P0824H2011	109P0824H2D011	—	80×80×32mm	No	✓	✓	✓	121
109P0824H601	109P0824H602	109P0824H601	109P0824H6D01	—	80×80×20mm	Yes	✓	✓	✓	99
109P0824H701	109P0824H702	109P0824H701	109P0824H7D01	—	80×80×15mm	Yes	✓	✓	✓	95
109P0824M201	109P0824M202	109P0824M201	109P0824M2D01	—	80×80×32mm	Yes	✓	✓	✓	121

Models listed in the main section of this catalog	List of models (models not listed in the main section of this catalog are options. Standards for optional model numbers may differ from the certified standards listed at right. Contact us for details of models with "-" model numbers.)				Frame Size	Rib	Standard (certification status is for the models listed in this catalog, and standards for optional model numbers may differ.)			page
	Without sensor	With pulse sensor	With lock sensor	With PWM control function and pulse sensor			UL (cUL)	CSA (cUL)	TÜV	
							✓	✓	✓	
109P0824M2011	109P0824M2021	109P0824M2011	109P0824M2D011	—	80×80×32mm	No	✓	✓	✓	121
109P0824M601	109P0824M602	109P0824M601	109P0824M6D01	—	80×80×20mm	Yes	✓	✓	✓	99
109P0824M701	109P0824M702	109P0824M701	109P0824M7D01	—	80×80×15mm	Yes	✓	✓	✓	95
109P0848C601	109P0848C602	109P0848C601	109P0848C6D01	—	80×80×20mm	Yes	✓	✓	✓	99
109P0848H201	109P0848H202	109P0848H201	109P0848H2D01	—	80×80×32mm	Yes	✓	✓	✓	121
109P0848H2011	109P0848H2021	109P0848H2011	—	—	80×80×32mm	No	✓	✓	✓	121
109P0848H601	—	109P0848H601	109P0848H6D01	—	80×80×20mm	Yes	✓	✓	✓	99
109P1312H101	109P1312H102	109P1312H101	109P1312H1D01	—	127×127×38mm	Yes	✓	✓	✓	179
109P1312H1011	109P1312H1021	109P1312H1011	109P1312H1D011	—	127×127×38mm	No	✓	✓	✓	179
109P1312S101	109P1312S102	109P1312S101	109P1312S1D01	—	127×127×38mm	Yes	✓	✓	✓	179
109P1312S1011	109P1312S1021	109P1312S1011	109P1312S1D011	—	127×127×38mm	No	✓	✓	✓	179
109P1324H101	109P1324H102	109P1324H101	109P1324H1D01	—	127×127×38mm	Yes	✓	✓	✓	179
109P1324H1011	109P1324H1021	109P1324H1011	109P1324H1D011	—	127×127×38mm	No	✓	✓	✓	179
109P1324S101	109P1324S102	109P1324S101	109P1324S1D01	—	127×127×38mm	Yes	✓	✓	✓	179
109P1324S1011	109P1324S1021	109P1324S1011	109P1324S1D011	—	127×127×38mm	No	✓	✓	✓	179
109P1348H101	109P1348H102	109P1348H101	109P1348H1D01	—	127×127×38mm	Yes	✓	✓	✓	179
109P1348H1011	109P1348H1021	109P1348H1011	109P1348H1D011	—	127×127×38mm	No	✓	✓	✓	179
109P1348S101	109P1348S102	109P1348S101	109P1348S1D01	—	127×127×38mm	Yes	✓	✓	✓	179
109P1348S1011	109P1348S1021	109P1348S1011	109P1348S1D011	—	127×127×38mm	No	✓	✓	✓	179
109P1412H101	109P1412H102	109P1412H101	109P1412H1D01	—	140×140×38mm	Yes	✓	✓	✓	187
109P1412M101	109P1412M102	109P1412M101	—	—	140×140×38mm	Yes	✓	✓	✓	187
109P1424H101	109P1424H102	109P1424H101	109P1424H1D01	—	140×140×38mm	Yes	✓	✓	✓	187
109P1424M101	109P1424M102	109P1424M101	—	—	140×140×38mm	Yes	✓	✓	✓	187
109P1448H101	109P1448H102	109P1448H101	—	—	140×140×38mm	Yes	✓	✓	✓	187
109P1448M101	109P1448M102	109P1448M101	—	—	140×140×38mm	Yes	✓	✓	✓	187
109R0605F401	109R0605F402	109R0605F401	109R0605F4D01	—	60×60×25mm	Yes	✓	✓	✓	71
109R0605F4011	109R0605F4021	109R0605F4011	—	—	60×60×25mm	No	✓	✓	✓	71
109R0605H401	109R0605H402	109R0605H401	109R0605H4D01	—	60×60×25mm	Yes	✓	✓	✓	71
109R0605H4011	109R0605H4021	109R0605H4011	—	—	60×60×25mm	No	✓	✓	✓	71
109R0605M401	109R0605M402	109R0605M401	109R0605M4D01	—	60×60×25mm	Yes	✓	✓	✓	71
109R0605M4011	109R0605M4021	109R0605M4011	—	—	60×60×25mm	No	✓	✓	✓	71
109R0612D401	109R0612D402	109R0612D401	109R0612D4D01	—	60×60×25mm	Yes	✓	✓	✓	71
109R0612D4011	109R0612D4021	109R0612D4011	109R0612D4D011	—	60×60×25mm	No	✓	✓	✓	71
109R0612F401	109R0612F402	109R0612F401	109R0612F4D01	—	60×60×25mm	Yes	✓	✓	✓	71
109R0612F4011	109R0612F4021	109R0612F4011	109R0612F4D011	—	60×60×25mm	No	✓	✓	✓	71
109R0612G401	109R0612G402	109R0612G401	109R0612G4D01	—	60×60×25mm	Yes	✓	✓	✓	71
109R0612G4011	109R0612G4021	109R0612G4011	109R0612G4D011	—	60×60×25mm	No	✓	✓	✓	71
109R0612H401	109R0612H402	109R0612H401	109R0612H4D01	—	60×60×25mm	Yes	✓	✓	✓	71
109R0612H4011	109R0612H4021	109R0612H4011	109R0612H4D011	—	60×60×25mm	No	✓	✓	✓	71
109R0612J401	109R0612J402	109R0612J401	109R0612J4D01	109R0612P4J03	60×60×25mm	Yes	✓	✓	✓	71
109R0612J4011	109R0612J4021	109R0612J4011	109R0612J4D011	109R0612P4J061	60×60×25mm	No	✓	✓	✓	71
109R0612M401	109R0612M402	109R0612M401	109R0612M4D01	—	60×60×25mm	Yes	✓	✓	✓	71
109R0612M4011	109R0612M4021	109R0612M4011	109R0612M4D011	—	60×60×25mm	No	✓	✓	✓	71
109R0612S401	109R0612S402	109R0612S401	109R0612S4D01	—	60×60×25mm	Yes	✓	✓	✓	71
109R0612S4011	109R0612S4021	109R0612S4011	109R0612S4D011	—	60×60×25mm	No	✓	✓	✓	71
109R0624D401	109R0624D402	109R0624D401	109R0624D4D01	—	60×60×25mm	Yes	✓	✓	✓	71
109R0624D4011	109R0624D4021	109R0624D4011	—	—	60×60×25mm	No	✓	✓	✓	71
109R0624F401	109R0624F402	109R0624F401	109R0624F4D01	—	60×60×25mm	Yes	✓	✓	✓	71
109R0624F4011	109R0624F4021	109R0624F4011	109R0624F4D011	—	60×60×25mm	No	✓	✓	✓	71
109R0624G401	109R0624G402	109R0624G401	109R0624G4D01	—	60×60×25mm	Yes	✓	✓	✓	71
109R0624G4011	109R0624G4021	109R0624G4011	109R0624G4D011	—	60×60×25mm	No	✓	✓	✓	71
109R0624H401	109R0624H402	109R0624H401	109R0624H4D01	—	60×60×25mm	Yes	✓	✓	✓	71
109R0624H4011	109R0624H4021	109R0624H4011	109R0624H4D011	—	60×60×25mm	No	✓	✓	✓	71
109R0624J401	109R0624J402	109R0624J401	109R0624J4D01	9RH0624P4J01	60×60×25mm	Yes	✓	✓	✓	71
109R0624J4011	109R0624J4021	109R0624J4011	109R0624J4D011	—	60×60×25mm	No	✓	✓	✓	71
109R0624M401	109R0624M402	109R0624M401	109R0624M4D01	—	60×60×25mm	Yes	✓	✓	✓	71
109R0624M4011	109R0624M4021	109R0624M4011	109R0624M4D011	—	60×60×25mm	No	✓	✓	✓	71
109R0624S401	109R0624S402	109R0624S401	109R0624S4D01	—	60×60×25mm	Yes	✓	✓	✓	71
109R0624S4011	109R0624S4021	109R0624S4011	109R0624S4D011	—	60×60×25mm	No	✓	✓	✓	71
109R0648G401	109R0648G402	109R0648G401	109R0648G4D01	—	60×60×25mm	Yes	✓	✓	✓	71
109R0648G4011	109R0648G4021	109R0648G4011	109R0648G4D011	—	60×60×25mm	No	✓	✓	✓	71
109R0648H401	109R0648H402	109R0648H401	109R0648H4D01	—	60×60×25mm	Yes	✓	✓	✓	71

Models listed in the main section of this catalog	List of models (models not listed in the main section of this catalog are options. Standards for optional model numbers may differ from the certified standards listed at right. Contact us for details of models with "-" model numbers.)				Frame Size	Rib	Standard (certification status is for the models listed in this catalog, and standards for optional model numbers may differ.)			page
	Without sensor	With pulse sensor	With lock sensor	With PWM control function and pulse sensor			UL (cUL)	CSA (cUL)	TÜV	
							✓	✓	✓	
109R0648H4011	109R0648H4021	109R0648H4011	109R0648H4D011	—	60×60×25mm	No	✓	✓	✓	71
109R0648J401	109R0648J402	109R0648J401	109R0648J4D01	—	60×60×25mm	Yes	✓	✓	✓	71
109R0648J4011	109R0648J4021	109R0648J4011	—	—	60×60×25mm	No	✓	✓	✓	71
109R0805F401	109R0805F402	109R0805F401	109R0805F4D01	—	80×80×25mm	Yes	✓	✓	✓	111
109R0805F4011	109R0805F4021	109R0805F4011	—	—	80×80×25mm	No	✓	✓	✓	111
109R0805M401	109R0805M402	109R0805M401	109R0805M4D01	—	80×80×25mm	Yes	✓	✓	✓	111
109R0805M4011	109R0805M4021	109R0805M4011	—	—	80×80×25mm	No	✓	✓	✓	111
109R0812E401	109R0812E402	109R0812E401	—	—	80×80×25mm	Yes	—	—	—	111
109R0812E4011	—	109R0812E4011	—	—	80×80×25mm	No	—	—	—	111
109R0812F401	109R0812F402	109R0812F401	109R0812F4D01	—	80×80×25mm	Yes	✓	✓	✓	111
109R0812F4011	109R0812F4021	109R0812F4011	109R0812F4D011	—	80×80×25mm	No	✓	✓	✓	111
109R0812G401	109R0812G402	109R0812G401	109R0812G4D01	—	80×80×25mm	Yes	✓	✓	✓	111
109R0812G4011	109R0812G4021	109R0812G4011	109R0812G4D011	—	80×80×25mm	No	✓	✓	✓	111
109R0812H401	109R0812H402	109R0812H401	109R0812H4D01	—	80×80×25mm	Yes	✓	✓	✓	111
109R0812H4011	109R0812H4021	109R0812H4011	109R0812H4D011	—	80×80×25mm	No	✓	✓	✓	111
109R0812L401	109R0812L402	109R0812L401	109R0812L4D01	—	80×80×25mm	Yes	✓	✓	✓	111
109R0812L4011	109R0812L4021	109R0812L4011	109R0812L4D011	—	80×80×25mm	No	✓	✓	✓	111
109R0812M401	109R0812M402	109R0812M401	109R0812M4D01	—	80×80×25mm	Yes	✓	✓	✓	111
109R0812M4011	109R0812M4021	109R0812M4011	109R0812M4D011	—	80×80×25mm	No	✓	✓	✓	111
109R0812S401	109R0812S402	109R0812S401	109R0812S4D01	—	80×80×25mm	Yes	✓	✓	✓	111
109R0812S4011	109R0812S4021	109R0812S4011	109R0812S4D011	—	80×80×25mm	No	✓	✓	✓	111
109R0824F401	109R0824F402	109R0824F401	109R0824F4D01	—	80×80×25mm	Yes	✓	✓	✓	111
109R0824F4011	109R0824F4021	109R0824F4011	109R0824F4D011	—	80×80×25mm	No	✓	✓	✓	111
109R0824G401	109R0824G402	109R0824G401	109R0824G4D01	—	80×80×25mm	Yes	✓	✓	✓	111
109R0824G4011	109R0824G4021	109R0824G4011	109R0824G4D011	—	80×80×25mm	No	✓	✓	✓	111
109R0824H401	109R0824H402	109R0824H401	109R0824H4D01	—	80×80×25mm	Yes	✓	✓	✓	111
109R0824H4011	109R0824H4021	109R0824H4011	109R0824H4D011	—	80×80×25mm	No	✓	✓	✓	111
109R0824L401	109R0824L402	109R0824L401	109R0824L4D01	—	80×80×25mm	Yes	✓	✓	✓	111
109R0824L4011	109R0824L4021	109R0824L4011	109R0824L4D011	—	80×80×25mm	No	✓	✓	✓	111
109R0824M401	109R0824M402	109R0824M401	109R0824M4D01	—	80×80×25mm	Yes	✓	✓	✓	111
109R0824M4011	109R0824M4021	109R0824M4011	109R0824M4D011	—	80×80×25mm	No	✓	✓	✓	111
109R0824S401	109R0824S402	109R0824S401	109R0824S4D01	—	80×80×25mm	Yes	✓	✓	✓	111
109R0824S4011	109R0824S4021	109R0824S4011	109R0824S4D011	—	80×80×25mm	No	✓	✓	✓	111
109R0848K401	109R0848K402	109R0848K401	109R0848K4D01	—	80×80×25mm	Yes	✓	✓	✓	111
109R0848K4011	109R0848K4021	109R0848K4011	109R0848K4D011	—	80×80×25mm	No	✓	✓	✓	111
109R0848S401	109R0848S402	109R0848S401	109R0848S4D01	—	80×80×25mm	Yes	✓	✓	✓	111
109R0848S4011	109R0848S4021	109R0848S4011	109R0848S4D011	—	80×80×25mm	No	✓	✓	✓	111
109W1412H101-U	109W1412H102-U	109W1412H101-U	—	—	140×140×38mm	No	✓	✓	✓	285
109W1412M101-U	109W1412M102-U	109W1412M101-U	109W1412M1D01-U	—	140×140×38mm	No	✓	✓	✓	285
109W1424H101-U	109W1424H102-U	109W1424H101-U	—	—	140×140×38mm	No	✓	✓	✓	285
109W1424M101-U	109W1424M102-U	109W1424M101-U	—	—	140×140×38mm	No	✓	✓	✓	285
109W1448H101-U	109W1448H102-U	109W1448H101-U	109W1448H1D01-U	—	140×140×38mm	No	✓	✓	✓	285
109W1448M101-U	109W1448M102-U	109W1448M101-U	—	—	140×140×38mm	No	✓	✓	✓	285
9A0612F401	9A0612F402	9A0612F401	9A0612F4D01	—	60×60×25mm	Yes	✓	✓	✓	75
9A0612F4011	9A0612F4021	9A0612F4011	9A0612F4D011	—	60×60×25mm	No	✓	✓	✓	75
9A0612G401	9A0612G402	9A0612G401	9A0612G4D01	9AH0612P4G03	60×60×25mm	Yes	✓	✓	✓	75
9A0612G4011	9A0612G4021	9A0612G4011	9A0612G4D011	—	60×60×25mm	No	✓	✓	✓	75
9A0612H401	9A0612H402	9A0612H401	9A0612H4D01	9AH0612P4H05	60×60×25mm	Yes	✓	✓	✓	75
9A0612H4011	9A0612H4021	9A0612H4011	9A0612H4D011	—	60×60×25mm	No	✓	✓	✓	75
9A0612M401	9A0612M402	9A0612M401	9A0612M4D01	—	60×60×25mm	Yes	✓	✓	✓	75
9A0612M4011	9A0612M4021	9A0612M4011	9A0612M4D011	—	60×60×25mm	No	✓	✓	✓	75
9A0612S401	9A0612S402	9A0612S401	9A0612S4D01	—	60×60×25mm	Yes	✓	✓	✓	75
9A0612S4011	9A0612S4021	9A0612S4011	9A0612S4D011	—	60×60×25mm	No	✓	✓	✓	75
9A0624F401	9A0624F402	9A0624F401	9A0624F4D01	—	60×60×25mm	Yes	✓	✓	✓	75
9A0624F4011	9A0624F4021	9A0624F4011	9A0624F4D011	—	60×60×25mm	No	✓	✓	✓	75
9A0624G401	9A0624G402	9A0624G401	9A0624G4D01	—	60×60×25mm	Yes	✓	✓	✓	75
9A0624G4011	9A0624G4021	9A0624G4011	—	—	60×60×25mm	No	✓	✓	✓	75
9A0624H401	9A0624H402	9A0624H401	9A0624H4D01	—	60×60×25mm	Yes	✓	✓	✓	75
9A0624H4011	9A0624H4021	9A0624H4011	9A0624H4D011	—	60×60×25mm	No	✓	✓	✓	75
9A0624M401	9A0624M402	9A0624M401	9A0624M4D01	—	60×60×25mm	Yes	✓	✓	✓	75
9A0624M4011	9A0624M4021	9A0624M4011	9A0624M4D011	—	60×60×25mm	No	✓	✓	✓	75
9A0624S401	9A0624S402	9A0624S401	9A0624S4D01	—	60×60×25mm	Yes	✓	✓	✓	75

Models listed in the main section of this catalog	List of models (models not listed in the main section of this catalog are options. Standards for optional model numbers may differ from the certified standards listed at right. Contact us for details of models with "-" model numbers.)				Frame Size	Rib	Standard (certification status is for the models listed in this catalog, and standards for optional model numbers may differ.)			page
	Without sensor	With pulse sensor	With lock sensor	With PWM control function and pulse sensor			UL (cUL)	CSA (cUL)	TÜV	
							✓	✓	✓	
9A0624S4011	9A0624S4021	9A0624S4011	9A0624S4D011	—	60×60×25mm	No	✓	✓	✓	75
9A0812F401	9A0812F402	9A0812F401	9A0812F4D01	—	80×80×25mm	Yes	✓	✓	✓	115
9A0812F4011	9A0812F4021	9A0812F4011	9A0812F4D011	—	80×80×25mm	No	✓	✓	✓	115
9A0812G401	9A0812G402	9A0812G401	9A0812G4D01	9AH0812P4G04	80×80×25mm	Yes	✓	✓	✓	115
9A0812G4011	9A0812G4021	9A0812G4011	9A0812G4D011	9AH0812P4G011	80×80×25mm	No	✓	✓	✓	115
9A0812H401	9A0812H402	9A0812H401	9A0812H4D01	9AH0812P4H04	80×80×25mm	Yes	✓	✓	✓	115
9A0812H4011	9A0812H4021	9A0812H4011	9A0812H4D011	—	80×80×25mm	No	✓	✓	✓	115
9A0812L401	9A0812L402	9A0812L401	9A0812L4D01	—	80×80×25mm	Yes	✓	✓	✓	115
9A0812L4011	9A0812L4021	9A0812L4011	9A0812L4D011	—	80×80×25mm	No	✓	✓	✓	115
9A0812M401	9A0812M402	9A0812M401	9A0812M4D01	—	80×80×25mm	Yes	✓	✓	✓	115
9A0812M4011	9A0812M4021	9A0812M4011	9A0812M4D011	—	80×80×25mm	No	✓	✓	✓	115
9A0812S401	9A0812S402	9A0812S401	9A0812S4D01	—	80×80×25mm	Yes	✓	✓	✓	115
9A0812S4011	9A0812S4021	9A0812S4011	9A0812S4D011	—	80×80×25mm	No	✓	✓	✓	115
9A0824F401	9A0824F402	9A0824F401	9A0824F4D01	—	80×80×25mm	Yes	✓	✓	✓	115
9A0824F4011	9A0824F4021	9A0824F4011	9A0824F4D011	—	80×80×25mm	No	✓	✓	✓	115
9A0824G401	9A0824G402	9A0824G401	9A0824G4D01	—	80×80×25mm	Yes	✓	✓	✓	115
9A0824G4011	9A0824G4021	9A0824G4011	9A0824G4D011	—	80×80×25mm	No	✓	✓	✓	115
9A0824H401	9A0824H402	9A0824H401	9A0824H4D01	—	80×80×25mm	Yes	✓	✓	✓	115
9A0824H4011	9A0824H4021	9A0824H4011	9A0824H4D011	—	80×80×25mm	No	✓	✓	✓	115
9A0824L401	9A0824L402	9A0824L401	9A0824L4D01	—	80×80×25mm	Yes	✓	✓	✓	115
9A0824L4011	9A0824L4021	9A0824L4011	9A0824L4D011	—	80×80×25mm	No	✓	✓	✓	115
9A0824M401	9A0824M402	9A0824M401	9A0824M4D01	—	80×80×25mm	Yes	✓	✓	✓	115
9A0824M4011	9A0824M4021	9A0824M4011	9A0824M4D011	—	80×80×25mm	No	✓	✓	✓	115
9A0824S401	9A0824S402	9A0824S401	9A0824S4D01	—	80×80×25mm	Yes	✓	✓	✓	115
9A0824S4011	9A0824S4021	9A0824S4011	9A0824S4D011	—	80×80×25mm	No	✓	✓	✓	115
9A0912F401	9A0912F402	9A0912F401	9A0912F4D01	—	92×92×25mm	Yes	✓	✓	✓	143
9A0912F4011	9A0912F4021	9A0912F4011	9A0912F4D011	—	92×92×25mm	No	✓	✓	✓	143
9A0912G401	9A0912G402	9A0912G401	9A0912G4D01	9AH0912P4G03	92×92×25mm	Yes	✓	✓	✓	143
9A0912G4011	9A0912G4021	9A0912G4011	9A0912G4D011	—	92×92×25mm	No	✓	✓	✓	143
9A0912H401	9A0912H402	9A0912H401	9A0912H4D01	9AH0912P4H03	92×92×25mm	Yes	✓	✓	✓	143
9A0912H4011	9A0912H4021	9A0912H4011	9A0912H4D011	—	92×92×25mm	No	✓	✓	✓	143
9A0912L401	9A0912L402	9A0912L401	9A0912L4D01	—	92×92×25mm	Yes	✓	✓	✓	143
9A0912L4011	9A0912L4021	9A0912L4011	9A0912L4D011	—	92×92×25mm	No	✓	✓	✓	143
9A0912M401	9A0912M402	9A0912M401	9A0912M4D01	—	92×92×25mm	Yes	✓	✓	✓	143
9A0912M4011	9A0912M4021	9A0912M4011	9A0912M4D011	—	92×92×25mm	No	✓	✓	✓	143
9A0912S401	9A0912S402	9A0912S401	9A0912S4D01	—	92×92×25mm	Yes	✓	✓	✓	143
9A0912S4011	9A0912S4021	9A0912S4011	9A0912S4D011	—	92×92×25mm	No	✓	✓	✓	143
9A0924F401	9A0924F402	9A0924F401	9A0924F4D01	—	92×92×25mm	Yes	✓	✓	✓	143
9A0924F4011	9A0924F4021	9A0924F4011	9A0924F4D011	—	92×92×25mm	No	✓	✓	✓	143
9A0924G401	9A0924G402	9A0924G401	9A0924G4D01	—	92×92×25mm	Yes	✓	✓	✓	143
9A0924G4011	9A0924G4021	9A0924G4011	—	—	92×92×25mm	No	✓	✓	✓	143
9A0924H401	9A0924H402	9A0924H401	9A0924H4D01	—	92×92×25mm	Yes	✓	✓	✓	143
9A0924H4011	9A0924H4021	9A0924H4011	9A0924H4D011	—	92×92×25mm	No	✓	✓	✓	143
9A0924L401	9A0924L402	9A0924L401	9A0924L4D01	—	92×92×25mm	Yes	✓	✓	✓	143
9A0924L4011	9A0924L4021	9A0924L4011	9A0924L4D011	—	92×92×25mm	No	✓	✓	✓	143
9A0924M401	9A0924M402	9A0924M401	9A0924M4D01	—	92×92×25mm	Yes	✓	✓	✓	143
9A0924M4011	9A0924M4021	9A0924M4011	9A0924M4D011	—	92×92×25mm	No	✓	✓	✓	143
9A0924S401	9A0924S402	9A0924S401	9A0924S4D01	—	92×92×25mm	Yes	✓	✓	✓	143
9A0924S4011	9A0924S4021	9A0924S4011	9A0924S4D011	—	92×92×25mm	No	✓	✓	✓	143
9A0948S401	9A0948S402	9A0948S401	9A0948S4D01	—	92×92×25mm	Yes	✓	✓	✓	143
9A0948S4011	9A0948S4021	9A0948S4011	—	—	92×92×25mm	No	✓	✓	✓	143
9B1TP24P0H001	—	—	—	9B1TP24P0H001	φ 270mm×99mm	—	✓	✓	✓	387
9B1TP48P0H001	—	—	—	9B1TP48P0H001	φ 270mm×99mm	—	✓	✓	✓	387
9B1TP48P0G001	—	—	—	9B1TP48P0G001	φ 270mm×99mm	—	✓	✓	✓	387
9B1TS48P0H001	—	—	—	9B1TS48P0H001	φ 270mm×119mm	—	✓	✓	✓	389
9B1TS48P0G001	—	—	—	9B1TS48P0G001	φ 270mm×119mm	—	✓	✓	✓	389
9BD12FC6-1	9BD12FA6-1	9BD12FC6-1	9BD12FD6-1	—	76mm×20mm	—	✓	✓	✓	395
9BD12HC6-1	9BD12HA6-1	9BD12HC6-1	9BD12HD6-1	—	76mm×20mm	—	✓	✓	✓	395
9BD12SC6-1	9BD12SA6-1	9BD12SC6-1	9BD12SD6-1	9BD12P6S01	76mm×20mm	—	✓	✓	✓	395
9BD24FC6-1	9BD24FA6-1	9BD24FC6-1	9BD24FD6-1	—	76mm×20mm	—	✓	✓	✓	395
9BD24HC6-1	9BD24HA6-1	9BD24HC6-1	9BD24HD6-1	—	76mm×20mm	—	✓	✓	✓	395
9BD24SC6-1	9BD24SA6-1	9BD24SC6-1	9BD24SD6-1	9BD24P6S06	76mm×20mm	—	✓	✓	✓	395

Models listed in the main section of this catalog	List of models (models not listed in the main section of this catalog are options. Standards for optional model numbers may differ from the certified standards listed at right. Contact us for details of models with "-" model numbers.)				Frame Size	Rib	Standard (certification status is for the models listed in this catalog, and standards for optional model numbers may differ.)			page
	Without sensor	With pulse sensor	With lock sensor	With PWM control function and pulse sensor			UL (cUL)	CSA (cUL)	TÜV	
							✓	✓	✓	
9BFB12P2H003	—	—	—	9BFB12P2H003	120mm×32mm	—	✓	✓	✓	407
9BFB24P2H003	—	—	—	9BFB24P2H003	120mm×32mm	—	✓	✓	✓	407
9BMB12F201	9BMB12F202	9BMB12F201	9BMB12F2D01	9BMB12P2F01	97mm×33mm	—	✓	✓	✓	401
9BMB12G201	9BMB12G202	9BMB12G201	9BMB12G2D01	9BMB12P2G01	97mm×33mm	—	✓	✓	✓	401
9BMB12H201	9BMB12H202	9BMB12H201	9BMB12H2D01	9BMB12P2H01	97mm×33mm	—	✓	✓	✓	401
9BMB12K201	9BMB12K202	9BMB12K201	—	9BMB12P2K01	97mm×33mm	—	✓	✓	✓	401
9BMB12P2F01	9BMB12F202	9BMB12F201	9BMB12F2D01	9BMB12P2F01	97mm×33mm	—	✓	✓	✓	401
9BMB12P2G01	9BMB12G202	9BMB12G201	9BMB12G2D01	9BMB12P2G01	97mm×33mm	—	✓	✓	✓	401
9BMB12P2H01	9BMB12H202	9BMB12H201	9BMB12H2D01	9BMB12P2H01	97mm×33mm	—	✓	✓	✓	401
9BMB12P2K01	9BMB12K202	9BMB12K201	—	9BMB12P2K01	97mm×33mm	—	✓	✓	✓	401
9BMB12P2S01	9BMB12S202	9BMB12S201	—	9BMB12P2S01	97mm×33mm	—	✓	✓	✓	401
9BMB12S201	9BMB12S202	9BMB12S201	—	9BMB12P2S01	97mm×33mm	—	✓	✓	✓	401
9BMB24F201	9BMB24F202	9BMB24F201	9BMB24F2D01	9BMB24P2F01	97mm×33mm	—	✓	✓	✓	401
9BMB24G201	9BMB24G202	9BMB24G201	9BMB24G2D01	9BMB24P2G01	97mm×33mm	—	✓	✓	✓	401
9BMB24H201	9BMB24H202	9BMB24H201	9BMB24H2D01	9BMB24P2H01	97mm×33mm	—	✓	✓	✓	401
9BMB24K201	9BMB24K202	9BMB24K201	—	9BMB24P2K01	97mm×33mm	—	✓	✓	✓	401
9BMB24P2F01	9BMB24F202	9BMB24F201	9BMB24F2D01	9BMB24P2F01	97mm×33mm	—	✓	✓	✓	401
9BMB24P2G01	9BMB24G202	9BMB24G201	9BMB24G2D01	9BMB24P2G01	97mm×33mm	—	✓	✓	✓	401
9BMB24P2H01	9BMB24H202	9BMB24H201	9BMB24H2D01	9BMB24P2H01	97mm×33mm	—	✓	✓	✓	401
9BMB24P2K01	9BMB24K202	9BMB24K201	—	9BMB24P2K01	97mm×33mm	—	✓	✓	✓	401
9BMB24P2S01	9BMB24S202	9BMB24S201	—	9BMB24P2S01	97mm×33mm	—	✓	✓	✓	401
9BMB24S201	9BMB24S202	9BMB24S201	—	9BMB24P2S01	97mm×33mm	—	✓	✓	✓	401
9CR0612P5G03	9CR0612G502	9CR0612G501	—	9CR0612P5G03	60×60×51mm	—	✓	✓	✓	221
9CR0612P5H03	—	9CR0612H501	—	9CR0612P5H03	60×60×51mm	—	✓	✓	✓	221
9CR1212P0G03	9CR1212G002	9CR1212G001	—	9CR1212P0G03	120×120×76mm	—	✓	✓	✓	237
9CR5748P9G001	—	—	—	9CR5748P9G001	φ172mm×150mm×102mm	—	✓	✓	✓	239
9CRA0312P4J03	—	9CRA0312J401	—	9CRA0312P4J03	38×38×48mm	—	✓	✓	✓	209
9CRA0312P4K03	9CRA0312K402	—	—	9CRA0312P4K03	38×38×48mm	—	✓	✓	✓	209
9CRA0412P4G03	9CRA0412G402	—	—	9CRA0412P4G03	40×40×48mm	—	✓	✓	✓	211
9CRA0412P4J03	9CRA0412J402	9CRA0412J401	—	9CRA0412P4J03	40×40×48mm	—	✓	✓	✓	211
9CRA0412P4K03	9CRA0412K402	9CRA0412K401	—	9CRA0412P4K03	40×40×48mm	—	✓	✓	✓	211
9CRA0612P0G001	—	—	—	9CRA0612P0G001	60×60×76mm	—	✓	✓	✓	227
9CRA0612P0S001	—	—	—	9CRA0612P0S001	60×60×76mm	—	✓	✓	✓	227
9CRA0612P6G001	—	—	—	9CRA0612P6G001	60×60×56mm	—	✓	✓	✓	223
9CRA0612P6J001	—	—	—	9CRA0612P6J001	60×60×56mm	—	✓	✓	✓	223
9CRA0612P6K001	—	—	—	9CRA0612P6K001	60×60×56mm	—	✓	✓	✓	223
9CRA0812P8G001	—	9CRA0812G8001	—	9CRA0812P8G001	80×80×80mm	—	✓	✓	✓	233
9CRA0824P8G001	—	—	—	9CRA0824P8G001	80×80×80mm	—	✓	✓	✓	233
9CRA0848P8G001	—	—	—	9CRA0848P8G001	80×80×80mm	—	✓	✓	✓	233
9CRA0912P0G001	—	—	—	9CRA0912P0G001	92×92×76mm	—	✓	✓	✓	235
9CRA0948P0G601	—	—	—	9CRA0948P0G601	92×92×76mm	—	✓	✓	✓	235
9CRB0412P5J201	—	—	—	9CRB0412P5J201	40×40×56mm	—	✓	✓	✓	213
9CRB0412P5K001	—	—	—	9CRB0412P5K001	40×40×56mm	—	✓	✓	✓	213
9CRB0412P5S201	—	—	—	9CRB0412P5S201	40×40×56mm	—	✓	✓	✓	213
9CRB0812P8G001	—	—	—	9CRB0812P8G001	80×80×80mm	—	✓	✓	✓	229
9CRD0412P5G03	—	—	—	9CRD0412P5G03	40×40×56mm	—	✓	✓	✓	215
9CRD0412P5H03	—	—	—	9CRD0412P5H03	40×40×56mm	—	✓	✓	✓	215
9CRD0412P5J03	—	—	—	9CRD0412P5J03	40×40×56mm	—	✓	✓	✓	215
9CRD0412P5M03	—	—	—	9CRD0412P5M03	40×40×56mm	—	✓	✓	✓	215
9CRE0412P5J03	9CRE0412J502	—	—	9CRE0412P5J03	40×40×56mm	—	✓	✓	✓	219
9CRE0612P0G001	—	—	—	9CRE0612P0G001	60×60×76mm	—	✓	✓	✓	225
9CRE0812P8G001	—	—	—	9CRE0812P8G001	80×80×80mm	—	✓	✓	✓	231
9CRL0612P0G001	—	—	—	9CRL0612P0G001	60×60×76mm	No	✓	✓	✓	327
9CRL0812P8G001	—	—	—	9CRL0812P8G001	80×80×80mm	No	✓	✓	✓	333
9EC2024H001	9EC2024H002	9EC2024H001	9EC2024H0D01	—	φ200mm×70mm	No	✓	✓	✓	205
9EC2048A001	9EC2048A002	9EC2048A001	9EC2048A0D01	9EC2048P0A01	φ200mm×70mm	No	✓	✓	✓	205
9EC2048H001	9EC2048H002	9EC2048H001	—	—	φ200mm×70mm	No	✓	✓	✓	205
9EC2048J001	9EC2048J002	9EC2048J001	—	9EC2048P0J01	φ200mm×70mm	No	—	—	—	205
9G0612G101	9G0612G102	9G0612G101	9G0612G1D01	9G0612P1G03	60×60×38mm	Yes	✓	✓	✓	87
9G0612G1011	9G0612G1021	9G0612G1011	9G0612G1D011	9G0612P1G011	60×60×38mm	No	✓	✓	✓	87
9G0612P4H001	9G0612H4002	—	9G0612H4D001	9G0612P4H001	60×60×25mm	Yes	✓	✓	✓	69
9G0612P4H0011	9G0612H40021	9G0612H40011	—	9G0612P4H0011	60×60×25mm	No	✓	✓	✓	69

Models listed in the main section of this catalog	List of models (models not listed in the main section of this catalog are options. Standards for optional model numbers may differ from the certified standards listed at right. Contact us for details of models with "-" model numbers.)				Frame Size	Rib	Standard (certification status is for the models listed in this catalog, and standards for optional model numbers may differ.)			page
	Without sensor	With pulse sensor	With lock sensor	With PWM control function and pulse sensor			UL (cUL)	CSA (cUL)	TÜV	
							✓	✓	✓	
9G0612P4S001	9G0612S4002	9G0612S4001	—	9G0612P4S001	60×60×25mm	Yes	✓	✓	✓	69
9G0612P4S0011	9G0612S40021	—	—	9G0612P4S0011	60×60×25mm	No	✓	✓	✓	69
9G0612S101	9G0612S102	9G0612S101	9G0612S1D01	—	60×60×38mm	Yes	✓	✓	✓	87
9G0612S1011	9G0612S1021	9G0612S1011	—	—	60×60×38mm	No	✓	✓	✓	87
9G0624G101	9G0624G102	9G0624G101	9G0624G1D01	9G0624P1G03	60×60×38mm	Yes	✓	✓	✓	87
9G0624G1011	9G0624G1021	9G0624G1011	9G0624G1D011	9G0624P1G031	60×60×38mm	No	✓	✓	✓	87
9G0624H101	9G0624H102	9G0624H101	9G0624H1D01	—	60×60×38mm	Yes	✓	✓	✓	87
9G0624H1011	9G0624H1021	9G0624H1011	—	—	60×60×38mm	No	✓	✓	✓	87
9G0624P4H001	9G0624H4002	9G0624H4001	9G0624H4D001	9G0624P4H001	60×60×25mm	Yes	✓	✓	✓	69
9G0624P4H0011	9G0624H40021	—	—	9G0624P4H0011	60×60×25mm	No	✓	✓	✓	69
9G0624P4S001	9G0624S4002	—	9G0624S4D001	9G0624P4S001	60×60×25mm	Yes	✓	✓	✓	69
9G0624P4S0011	—	—	—	9G0624P4S0011	60×60×25mm	No	✓	✓	✓	69
9G0624S101	9G0624S102	9G0624S101	9G0624S1D01	—	60×60×38mm	Yes	✓	✓	✓	87
9G0624S1011	9G0624S1021	9G0624S1011	—	—	60×60×38mm	No	✓	✓	✓	87
9G0648G101	9G0648G102	9G0648G101	9G0648G1D01	9G0648P1G01	60×60×38mm	Yes	✓	✓	✓	87
9G0648G1011	9G0648G1021	9G0648G1011	—	9G0648P1G011	60×60×38mm	No	✓	✓	✓	87
9G0648P4S001	—	—	—	9G0648P4S001	60×60×25mm	Yes	✓	✓	✓	69
9G0648P4S0011	—	—	—	9G0648P4S0011	60×60×25mm	No	✓	✓	✓	69
9G0648S101	9G0648S102	9G0648S101	9G0648S1D01	—	60×60×38mm	Yes	✓	✓	✓	87
9G0648S1011	9G0648S1021	9G0648S1011	—	—	60×60×38mm	No	✓	✓	✓	87
9G0812G101	9G0812G102	9G0812G101	9G0812G1D01	9G0812P1G04	80×80×38mm	Yes	✓	✓	✓	135
9G0812G1011	9G0812G1021	9G0812G1011	9G0812G1D011	9G0812P1G081	80×80×38mm	No	✓	✓	✓	135
9G0812H101	9G0812H102	9G0812H101	9G0812H1D01	9G0812P1H03	80×80×38mm	Yes	✓	✓	✓	135
9G0812H1011	9G0812H1021	9G0812H1011	9G0812H1D011	9G0812P1H051	80×80×38mm	No	✓	✓	✓	135
9G0812K101	9G0812K102	9G0812K101	9G0812K1D01	9G0812P1K08	80×80×38mm	Yes	✓	✓	✓	135
9G0812K1011	9G0812K1021	9G0812K1011	—	9G0812P1K081	80×80×38mm	No	✓	✓	✓	135
9G0824G101	9G0824G102	9G0824G101	9G0824G1D01	9G0824P1G04	80×80×38mm	Yes	✓	✓	✓	135
9G0824G1011	9G0824G1021	9G0824G1011	9G0824G1D011	—	80×80×38mm	No	✓	✓	✓	135
9G0824H101	9G0824H102	9G0824H101	9G0824H1D01	—	80×80×38mm	Yes	✓	✓	✓	135
9G0824H1011	9G0824H1021	9G0824H1011	9G0824H1D011	—	80×80×38mm	No	✓	✓	✓	135
9G0848G101	9G0848G102	9G0848G101	9G0848G1D01	9G0848P1G03	80×80×38mm	Yes	✓	✓	✓	135
9G0848G1011	9G0848G1021	9G0848G1011	9G0848G1D011	—	80×80×38mm	No	✓	✓	✓	135
9G0848H101	9G0848H102	9G0848H101	9G0848H1D01	9G0848P1H04	80×80×38mm	Yes	✓	✓	✓	135
9G0848H1011	9G0848H1021	9G0848H1011	—	—	80×80×38mm	No	✓	✓	✓	135
9G0912A201	9G0912A202	9G0912A201	9G0912A2D01	—	92×92×32mm	Yes	✓	✓	✓	145
9G0912A2011	9G0912A2021	9G0912A2011	9G0912A2D011	—	92×92×32mm	No	✓	✓	✓	145
9G0912G101	9G0912G102	9G0912G101	9G0912G1D01	9G0912P1G03	92×92×38mm	Yes	✓	✓	✓	155
9G0912G1011	9G0912G1021	9G0912G1011	—	9G0912P1G031	92×92×38mm	No	✓	✓	✓	155
9G0912H101	9G0912H102	9G0912H101	9G0912H1D01	9G0912P1H05	92×92×38mm	Yes	✓	✓	✓	155
9G0912H1011	9G0912H1021	9G0912H1011	9G0912H1D011	—	92×92×38mm	No	✓	✓	✓	155
9G0912H201	9G0912H202	9G0912H201	9G0912H2D01	9G0912P2H01	92×92×32mm	Yes	✓	✓	✓	145
9G0912H2011	9G0912H2021	9G0912H2011	9G0912H2D011	—	92×92×32mm	No	✓	✓	✓	145
9G0912M201	9G0912M202	9G0912M201	9G0912M2D01	—	92×92×32mm	Yes	✓	✓	✓	145
9G0912M2011	9G0912M2021	9G0912M2011	9G0912M2D011	—	92×92×32mm	No	✓	✓	✓	145
9G0912S201	9G0912S202	9G0912S201	9G0912S2D01	9G0912P2S01	92×92×32mm	Yes	✓	✓	✓	145
9G0912S2011	9G0912S2021	9G0912S2011	9G0912S2D011	—	92×92×32mm	No	✓	✓	✓	145
9G0924A201	9G0924A202	9G0924A201	9G0924A2D01	—	92×92×32mm	Yes	✓	✓	✓	145
9G0924A2011	9G0924A2021	9G0924A2011	9G0924A2D011	—	92×92×32mm	No	✓	✓	✓	145
9G0924G101	9G0924G102	9G0924G101	9G0924G1D01	—	92×92×38mm	Yes	✓	✓	✓	155
9G0924G1011	9G0924G1021	9G0924G1011	9G0924G1D011	—	92×92×38mm	No	✓	✓	✓	155
9G0924H101	9G0924H102	9G0924H101	9G0924H1D01	—	92×92×38mm	Yes	✓	✓	✓	155
9G0924H1011	9G0924H1021	9G0924H1011	9G0924H1D011	—	92×92×38mm	No	✓	✓	✓	155
9G0924H201	9G0924H202	9G0924H201	9G0924H2D01	—	92×92×32mm	Yes	✓	✓	✓	145
9G0924H2011	9G0924H2021	9G0924H2011	9G0924H2D011	—	92×92×32mm	No	✓	✓	✓	145
9G0924M201	9G0924M202	9G0924M201	9G0924M2D01	—	92×92×32mm	Yes	✓	✓	✓	145
9G0924M2011	9G0924M2021	9G0924M2011	9G0924M2D011	—	92×92×32mm	No	✓	✓	✓	145
9G0924S201	9G0924S202	9G0924S201	9G0924S2D01	—	92×92×32mm	Yes	✓	✓	✓	145
9G0924S2011	9G0924S2021	9G0924S2011	9G0924S2D011	—	92×92×32mm	No	✓	✓	✓	145
9G0948A201	9G0948A202	9G0948A201	9G0948A2D01	—	92×92×32mm	Yes	✓	✓	✓	145
9G0948A2011	9G0948A2021	9G0948A2011	9G0948A2D011	—	92×92×32mm	No	✓	✓	✓	145
9G0948G101	9G0948G102	9G0948G101	9G0948G1D01	—	92×92×38mm	Yes	✓	✓	✓	155
9G0948G1011	9G0948G1021	9G0948G1011	—	—	92×92×38mm	No	✓	✓	✓	155

Models listed in the main section of this catalog	List of models (models not listed in the main section of this catalog are options. Standards for optional model numbers may differ from the certified standards listed at right. Contact us for details of models with "-" model numbers.)				Frame Size	Rib	Standard (certification status is for the models listed in this catalog, and standards for optional model numbers may differ.)			page
	Without sensor	With pulse sensor	With lock sensor	With PWM control function and pulse sensor			UL (cUL)	CSA (cUL)	TÜV	
							✓	✓	✓	
9G0948H101	9G0948H102	9G0948H101	9G0948H1D01	—	92×92×38mm	Yes	✓	✓	✓	155
9G0948H1011	—	9G0948H1011	—	—	92×92×38mm	No	✓	✓	✓	155
9G0948H201	9G0948H202	9G0948H201	9G0948H2D01	—	92×92×32mm	Yes	✓	✓	✓	145
9G0948H2011	9G0948H2021	9G0948H2011	9G0948H2D011	—	92×92×32mm	No	✓	✓	✓	145
9G0948J101	—	9G0948J101	—	—	92×92×38mm	Yes	✓	✓	✓	155
9G0948J1011	—	9G0948J1011	—	9G0948P1J031	92×92×38mm	No	✓	✓	✓	155
9G0948M201	9G0948M202	9G0948M201	9G0948M2D01	—	92×92×32mm	Yes	✓	✓	✓	145
9G0948M2011	9G0948M2021	9G0948M2011	9G0948M2D011	—	92×92×32mm	No	✓	✓	✓	145
9G0948S201	9G0948S202	9G0948S201	9G0948S2D01	—	92×92×32mm	Yes	✓	✓	✓	145
9G0948S2011	9G0948S2021	9G0948S2011	9G0948S2D011	—	92×92×32mm	No	✓	✓	✓	145
9G1212A401	9G1212A402	9G1212A401	9G1212A4D01	—	120×120×25mm	Yes	✓	✓	✓	163
9G1212A4011	9G1212A4021	9G1212A4011	9G1212A4D011	—	120×120×25mm	No	✓	✓	✓	163
9G1212B401	—	9G1212B401	—	—	120×120×25mm	Yes	—	—	—	163
9G1212B4011	—	9G1212B4011	—	—	120×120×25mm	No	—	—	—	163
9G1212E101	9G1212E102	9G1212E101	9G1212E1D01	—	120×120×38mm	Yes	✓	✓	✓	173
9G1212E1011	9G1212E1021	9G1212E1011	9G1212E1D011	—	120×120×38mm	No	✓	✓	✓	173
9G1212E401	9G1212E402	9G1212E401	9G1212E4D01	9G1212P4E05	120×120×25mm	Yes	✓	✓	✓	163
9G1212E4011	9G1212E4021	9G1212E4011	9G1212E4D011	9G1212P4E041	120×120×25mm	No	✓	✓	✓	163
9G1212F101	9G1212F102	9G1212F101	—	—	120×120×38mm	Yes	✓	✓	✓	173
9G1212F1011	9G1212F1021	9G1212F1011	—	—	120×120×38mm	No	✓	✓	✓	173
9G1212F401	9G1212F402	9G1212F401	9G1212F4D01	—	120×120×25mm	Yes	✓	✓	✓	163
9G1212F4011	9G1212F4021	9G1212F4011	9G1212F4D011	—	120×120×25mm	No	✓	✓	✓	163
9G1212G101	9G1212G102	9G1212G101	9G1212G1D01	9G1212P1G04	120×120×38mm	Yes	✓	✓	✓	173
9G1212G1011	9G1212G1021	9G1212G1011	9G1212G1D011	9G1212P1G081	120×120×38mm	No	✓	✓	✓	173
9G1212G401	9G1212G402	9G1212G401	9G1212G4D01	9G1212P4G03	120×120×25mm	Yes	✓	✓	✓	163
9G1212G4011	9G1212G4021	9G1212G4011	9G1212G4D011	9G1212P4G031	120×120×25mm	No	✓	✓	✓	163
9G1212H101	9G1212H102	9G1212H101	9G1212H1D01	—	120×120×38mm	Yes	✓	✓	✓	173
9G1212H1011	9G1212H1021	9G1212H1011	9G1212H1D011	—	120×120×38mm	No	✓	✓	✓	173
9G1212H401	9G1212H402	9G1212H401	9G1212H4D01	9G1212P4H04	120×120×25mm	Yes	✓	✓	✓	163
9G1212H4011	9G1212H4021	9G1212H4011	9G1212H4D011	9G1212P4H091	120×120×25mm	No	✓	✓	✓	163
9G1212M101	9G1212M102	9G1212M101	9G1212M1D01	—	120×120×38mm	Yes	✓	✓	✓	173
9G1212M1011	9G1212M1021	9G1212M1011	9G1212M1D011	—	120×120×38mm	No	✓	✓	✓	173
9G1212M401	9G1212M402	9G1212M401	9G1212M4D01	—	120×120×25mm	Yes	✓	✓	✓	163
9G1212M4011	9G1212M4021	9G1212M4011	9G1212M4D011	—	120×120×25mm	No	✓	✓	✓	163
9G1224A401	9G1224A402	9G1224A401	9G1224A4D01	—	120×120×25mm	Yes	✓	✓	✓	163
9G1224A4011	9G1224A4021	9G1224A4011	9G1224A4D011	—	120×120×25mm	No	✓	✓	✓	163
9G1224E101	9G1224E102	9G1224E101	9G1224E1D01	—	120×120×38mm	Yes	✓	✓	✓	173
9G1224E1011	9G1224E1021	9G1224E1011	9G1224E1D011	—	120×120×38mm	No	✓	✓	✓	173
9G1224E401	9G1224E402	9G1224E401	9G1224E4D01	9G1224P4E01	120×120×25mm	Yes	✓	✓	✓	163
9G1224E4011	9G1224E4021	9G1224E4011	9G1224E4D011	—	120×120×25mm	No	✓	✓	✓	163
9G1224F101	9G1224F102	9G1224F101	9G1224F1D01	—	120×120×38mm	Yes	✓	✓	✓	173
9G1224F1011	9G1224F1021	9G1224F1011	—	—	120×120×38mm	No	✓	✓	✓	173
9G1224F401	9G1224F402	9G1224F401	9G1224F4D01	—	120×120×25mm	Yes	✓	✓	✓	163
9G1224F4011	9G1224F4021	9G1224F4011	9G1224F4D011	—	120×120×25mm	No	✓	✓	✓	163
9G1224G101	9G1224G102	9G1224G101	9G1224G1D01	9G1224P1G01	120×120×38mm	Yes	✓	✓	✓	173
9G1224G1011	9G1224G1021	9G1224G1011	9G1224G1D011	—	120×120×38mm	No	✓	✓	✓	173
9G1224G401	9G1224G402	9G1224G401	9G1224G4D01	—	120×120×25mm	Yes	✓	✓	✓	163
9G1224G4011	9G1224G4021	9G1224G4011	9G1224G4D011	—	120×120×25mm	No	✓	✓	✓	163
9G1224H101	9G1224H102	9G1224H101	9G1224H1D01	—	120×120×38mm	Yes	✓	✓	✓	173
9G1224H1011	9G1224H1021	9G1224H1011	9G1224H1D011	—	120×120×38mm	No	✓	✓	✓	173
9G1224H401	9G1224H402	9G1224H401	9G1224H4D01	—	120×120×25mm	Yes	✓	✓	✓	163
9G1224H4011	9G1224H4021	9G1224H4011	9G1224H4D011	—	120×120×25mm	No	✓	✓	✓	163
9G1224M101	9G1224M102	9G1224M101	9G1224M1D01	—	120×120×38mm	Yes	✓	✓	✓	173
9G1224M1011	9G1224M1021	9G1224M1011	9G1224M1D011	—	120×120×38mm	No	✓	✓	✓	173
9G1224M401	9G1224M402	9G1224M401	9G1224M4D01	—	120×120×25mm	Yes	✓	✓	✓	163
9G1224M4011	9G1224M4021	9G1224M4011	9G1224M4D011	—	120×120×25mm	No	✓	✓	✓	163
9G1248A401	9G1248A402	9G1248A401	9G1248A4D01	—	120×120×25mm	Yes	✓	✓	✓	163
9G1248A4011	9G1248A4021	9G1248A4011	9G1248A4D011	—	120×120×25mm	No	✓	✓	✓	163
9G1248E101	9G1248E102	9G1248E101	9G1248E1D01	—	120×120×38mm	Yes	✓	✓	✓	173
9G1248E1011	9G1248E1021	9G1248E1011	9G1248E1D011	—	120×120×38mm	No	✓	✓	✓	173
9G1248E401	9G1248E402	9G1248E401	9G1248E4D01	9G1248P4E05	120×120×25mm	Yes	✓	✓	✓	163
9G1248E4011	9G1248E4021	9G1248E4011	9G1248E4D011	—	120×120×25mm	No	✓	✓	✓	163

Models listed in the main section of this catalog	List of models (models not listed in the main section of this catalog are options. Standards for optional model numbers may differ from the certified standards listed at right. Contact us for details of models with "-" model numbers.)				Frame Size	Rib	Standard (certification status is for the models listed in this catalog, and standards for optional model numbers may differ.)			page
	Without sensor	With pulse sensor	With lock sensor	With PWM control function and pulse sensor			UL (cUL)	CSA (cUL)	TÜV	
							✓	✓	✓	
9G1248F101	9G1248F102	9G1248F101	9G1248F1D01	—	120×120×38mm	Yes	✓	✓	✓	173
9G1248F1011	9G1248F1021	9G1248F1011	—	—	120×120×38mm	No	✓	✓	✓	173
9G1248F401	9G1248F402	9G1248F401	9G1248F4D01	—	120×120×25mm	Yes	✓	✓	✓	163
9G1248F4011	9G1248F4021	9G1248F4011	9G1248F4D011	—	120×120×25mm	No	✓	✓	✓	163
9G1248G101	9G1248G102	9G1248G101	9G1248G1D01	9G1248P1G04	120×120×38mm	Yes	✓	✓	✓	173
9G1248G1011	9G1248G1021	9G1248G1011	9G1248G1D011	9G1248P1G041	120×120×38mm	No	✓	✓	✓	173
9G1248G401	9G1248G402	9G1248G401	9G1248G4D01	9G1248P4G04	120×120×25mm	Yes	✓	✓	✓	163
9G1248G4011	9G1248G4021	9G1248G4011	9G1248G4D011	—	120×120×25mm	No	✓	✓	✓	163
9G1248H101	9G1248H102	9G1248H101	9G1248H1D01	—	120×120×38mm	Yes	✓	✓	✓	173
9G1248H1011	9G1248H1021	9G1248H1011	9G1248H1D011	—	120×120×38mm	No	✓	✓	✓	173
9G1248H401	9G1248H402	9G1248H401	9G1248H4D01	—	120×120×25mm	Yes	✓	✓	✓	163
9G1248H4011	9G1248H4021	9G1248H4011	9G1248H4D011	—	120×120×25mm	No	✓	✓	✓	163
9G1248M101	9G1248M102	9G1248M101	9G1248M1D01	—	120×120×38mm	Yes	✓	✓	✓	173
9G1248M1011	9G1248M1021	9G1248M1011	9G1248M1D011	—	120×120×38mm	No	✓	✓	✓	173
9G1248M401	9G1248M402	9G1248M401	9G1248M4D01	—	120×120×25mm	Yes	✓	✓	✓	163
9G1248M4011	9G1248M4021	9G1248M4011	9G1248M4D011	—	120×120×25mm	No	✓	✓	✓	163
9GA0312P3G001	—	9GA0312G3001	—	9GA0312P3G001	38×38×28mm	Yes	✓	✓	✓	13
9GA0312P3G0011	—	—	—	9GA0312P3G0011	38×38×28mm	No	✓	✓	✓	13
9GA0312P3J001	—	9GA0312J3001	—	9GA0312P3J001	38×38×28mm	Yes	✓	✓	✓	13
9GA0312P3J0011	—	—	—	9GA0312P3J0011	38×38×28mm	No	✓	✓	✓	13
9GA0312P3K001	—	9GA0312K3001	—	9GA0312P3K001	38×38×28mm	Yes	✓	✓	✓	13
9GA0312P3K0011	—	—	—	9GA0312P3K0011	38×38×28mm	No	✓	✓	✓	13
9GA0405P6F001	9GA0405F6002	9GA0405F6001	—	9GA0405P6F001	40×40×20mm	Yes	✓	✓	✓	23
9GA0405P6H001	9GA0405H6002	9GA0405H6001	—	9GA0405P6H001	40×40×20mm	Yes	✓	✓	✓	23
9GA0412G7001	9GA0412G7002	9GA0412G7001	9GA0412G7D001	9GA0412P7G001	40×40×15mm	Yes	✓	✓	✓	19
9GA0412H7001	9GA0412H7002	9GA0412H7001	9GA0412H7D001	—	40×40×15mm	Yes	✓	✓	✓	19
9GA0412P3G01	9GA0412G302	9GA0412G301	—	9GA0412P3G01	40×40×28mm	Yes	✓	✓	✓	35
9GA0412P3G011	9GA0412G3021	9GA0412G3011	—	9GA0412P3G011	40×40×28mm	No	✓	✓	✓	35
9GA0412P3H01	9GA0412H302	9GA0412H301	9GA0412H3D01	9GA0412P3H01	40×40×28mm	Yes	✓	✓	✓	35
9GA0412P3H011	9GA0412H3021	9GA0412H3011	9GA0412H3D011	9GA0412P3H011	40×40×28mm	No	✓	✓	✓	35
9GA0412P3J01	9GA0412J302	9GA0412J301	9GA0412J3D01	9GA0412P3J01	40×40×28mm	Yes	✓	✓	✓	35
9GA0412P3J011	9GA0412J3021	9GA0412J3011	—	9GA0412P3J011	40×40×28mm	No	✓	✓	✓	35
9GA0412P3K01	9GA0412K302	9GA0412K301	9GA0412K3D01	9GA0412P3K01	40×40×28mm	Yes	✓	✓	✓	35
9GA0412P3K011	9GA0412K3021	9GA0412K3011	—	9GA0412P3K011	40×40×28mm	No	✓	✓	✓	35
9GA0412P3M01	9GA0412M302	9GA0412M301	9GA0412M3D01	9GA0412P3M01	40×40×28mm	Yes	✓	✓	✓	35
9GA0412P3M011	9GA0412M3021	9GA0412M3011	—	9GA0412P3M011	40×40×28mm	No	✓	✓	✓	35
9GA0412P6F001	9GA0412F6002	9GA0412F6001	—	9GA0412P6F001	40×40×20mm	Yes	✓	✓	✓	23
9GA0412P6G001	9GA0412G6002	9GA0412G6001	—	9GA0412P6G001	40×40×20mm	Yes	✓	✓	✓	23
9GA0412P6H001	9GA0412H6002	9GA0412H6001	—	9GA0412P6H001	40×40×20mm	Yes	✓	✓	✓	23
9GA0412P7G001	9GA0412G7002	9GA0412G7001	9GA0412G7D001	9GA0412P7G001	40×40×15mm	Yes	✓	✓	✓	19
9GA0424P3G001	9GA0424G3002	9GA0424G3001	9GA0424G3D001	9GA0424P3G001	40×40×28mm	Yes	✓	✓	✓	35
9GA0424P3G0011	9GA0424G30021	9GA0424G30011	—	9GA0424P3G0011	40×40×28mm	No	✓	✓	✓	35
9GA0424P3H001	9GA0424H3002	9GA0424H3001	9GA0424H3D001	9GA0424P3H001	40×40×28mm	Yes	✓	✓	✓	35
9GA0424P3H0011	9GA0424H30021	9GA0424H30011	—	9GA0424P3H0011	40×40×28mm	No	✓	✓	✓	35
9GA0424P3J001	9GA0424J3002	9GA0424J3001	9GA0424J3D001	9GA0424P3J001	40×40×28mm	Yes	✓	✓	✓	35
9GA0424P3J0011	9GA0424J30021	9GA0424J30011	—	9GA0424P3J0011	40×40×28mm	No	✓	✓	✓	35
9GA0424P3M001	9GA0424M3002	9GA0424M3001	—	9GA0424P3M001	40×40×28mm	Yes	✓	✓	✓	35
9GA0424P3M0011	9GA0424M30021	9GA0424M30011	9GA0424M3D001	9GA0424P3M0011	40×40×28mm	No	✓	✓	✓	35
9GA0424P6F001	9GA0424F6002	9GA0424F6001	—	9GA0424P6F001	40×40×20mm	Yes	✓	✓	✓	23
9GA0424P6G001	9GA0424G6002	9GA0424G6001	9GA0424G6D001	9GA0424P6G001	40×40×20mm	Yes	✓	✓	✓	23
9GA0424P6H001	9GA0424H6002	9GA0424H6001	9GA0424H6D001	9GA0424P6H001	40×40×20mm	Yes	✓	✓	✓	23
9GA0512P7A001	9GA0512A7002	9GA0512A7001	—	9GA0512P7A001	52×52×15mm	Yes	✓	✓	✓	47
9GA0512P7G001	9GA0512G7002	9GA0512G7001	—	9GA0512P7G001	52×52×15mm	Yes	✓	✓	✓	47
9GA0512P7H001	9GA0512H7002	9GA0512H7001	—	9GA0512P7H001	52×52×15mm	Yes	✓	✓	✓	47
9GA0512P7M001	9GA0512M7002	9GA0512M7001	—	9GA0512P7M001	52×52×15mm	Yes	✓	✓	✓	47
9GA0524P7A001	9GA0524A7002	9GA0524A7001	—	9GA0524P7A001	52×52×15mm	Yes	✓	✓	✓	47
9GA0524P7G001	9GA0524G7002	9GA0524G7001	—	9GA0524P7G001	52×52×15mm	Yes	✓	✓	✓	47
9GA0524P7H001	9GA0524H7002	9GA0524H7001	—	9GA0524P7H001	52×52×15mm	Yes	✓	✓	✓	47
9GA0524P7M001	9GA0524M7002	9GA0524M7001	—	9GA0524P7M001	52×52×15mm	Yes	✓	✓	✓	47
9GA0612G701	9GA0612G702	9GA0612G701	9GA0612G7D01	9GA0612P7G01	60×60×15mm	Yes	✓	✓	✓	55
9GA0612G9001	9GA0612G9002	9GA0612G9001	9GA0612G9D001	9GA0612P9G001	60×60×10mm	No	✓	✓	✓	53
9GA0612H6001	9GA0612H6002	9GA0612H6001	9GA0612H6D001	—	60×60×20mm	Yes	✓	✓	✓	61

Please contact your point of sale regarding low-speed sensors.

Models listed in the main section of this catalog	List of models (models not listed in the main section of this catalog are options. Standards for optional model numbers may differ from the certified standards listed at right. Contact us for details of models with "-" model numbers.)				Frame Size	Rib	Standard (certification status is for the models listed in this catalog, and standards for optional model numbers may differ.)			page
	Without sensor	With pulse sensor	With lock sensor	With PWM control function and pulse sensor			UL	CSA	TÜV	
							(cUL)	(cUL)		
9GA0612H701	9GA0612H702	9GA0612H701	9GA0612H7D01	9GA0612P7H01	60×60×15mm	Yes	✓	✓	✓	55
9GA0612H9001	9GA0612H9002	9GA0612H9001	9GA0612H9D001	—	60×60×10mm	No	✓	✓	✓	53
9GA0612L701	9GA0612L702	9GA0612L701	9GA0612L7D01	—	60×60×15mm	Yes	✓	✓	✓	55
9GA0612L9001	9GA0612L9002	9GA0612L9001	9GA0612L9D001	—	60×60×10mm	No	✓	✓	✓	53
9GA0612M6001	9GA0612M6002	9GA0612M6001	9GA0612M6D001	—	60×60×20mm	Yes	✓	✓	✓	61
9GA0612M701	9GA0612M702	9GA0612M701	—	—	60×60×15mm	Yes	✓	✓	✓	55
9GA0612P1H03	9GA0612H102	9GA0612H101	—	9GA0612P1H03	60×60×38mm	Yes	✓	✓	✓	79
9GA0612P1H031	9GA0612H1021	9GA0612H1011	—	9GA0612P1H031	60×60×38mm	No	✓	✓	✓	79
9GA0612P1J03	9GA0612J102	9GA0612J101	9GA0612J1D01	9GA0612P1J03	60×60×38mm	Yes	✓	✓	✓	79
9GA0612P1J031	9GA0612J1021	9GA0612J1011	—	9GA0612P1J031	60×60×38mm	No	✓	✓	✓	79
9GA0612P1K03	9GA0612K102	9GA0612K101	9GA0612K1D011	9GA0612P1K03	60×60×38mm	Yes	✓	✓	✓	79
9GA0612P1K031	9GA0612K1021	9GA0612K1011	—	9GA0612P1K031	60×60×38mm	No	✓	✓	✓	79
9GA0612P1K60	—	—	—	9GA0612P1K60	60×60×38mm	Yes	✓	✓	✓	79
9GA0612P1K601	—	—	—	9GA0612P1K601	60×60×38mm	No	✓	✓	✓	79
9GA0612P6G001	9GA0612G6002	9GA0612G6001	—	9GA0612P6G001	60×60×20mm	Yes	✓	✓	✓	61
9GA0612P6S001	9GA0612S6002	9GA0612S6001	—	9GA0612P6S001	60×60×20mm	Yes	✓	✓	✓	61
9GA0612P7G01	9GA0612G702	9GA0612G701	9GA0612G7D01	9GA0612P7G01	60×60×15mm	Yes	✓	✓	✓	55
9GA0612P7H01	9GA0612H702	9GA0612H701	9GA0612H7D01	9GA0612P7H01	60×60×15mm	Yes	✓	✓	✓	55
9GA0624H6001	9GA0624H6002	9GA0624H6001	9GA0624H6D001	—	60×60×20mm	Yes	✓	✓	✓	61
9GA0624M6001	9GA0624M6002	9GA0624M6001	9GA0624M6D001	—	60×60×20mm	Yes	✓	✓	✓	61
9GA0624P1J03	9GA0624J102	9GA0624J101	—	9GA0624P1J03	60×60×38mm	Yes	✓	✓	✓	79
9GA0624P1J031	9GA0624J1021	9GA0624J1011	—	9GA0624P1J031	60×60×38mm	No	✓	✓	✓	79
9GA0624P1K03	—	—	—	9GA0624P1K03	60×60×38mm	Yes	✓	✓	✓	79
9GA0624P1K031	—	—	—	9GA0624P1K031	60×60×38mm	No	✓	✓	✓	79
9GA0624P6G001	9GA0624G6002	—	—	9GA0624P6G001	60×60×20mm	Yes	✓	✓	✓	61
9GA0624P6S001	9GA0624S6002	—	—	9GA0624P6S001	60×60×20mm	Yes	✓	✓	✓	61
9GA0624P7G01	9GA0624G702	—	—	9GA0624P7G01	60×60×15mm	Yes	—	—	✓	55
9GA0712P1G001	—	—	—	9GA0712P1G001	70×70×38mm	Yes	✓	✓	✓	89
9GA0712P1G0011	—	—	—	9GA0712P1G0011	70×70×38mm	No	✓	✓	✓	89
9GA0712P1H001	—	—	—	9GA0712P1H001	70×70×38mm	Yes	✓	✓	✓	89
9GA0712P1H0011	—	—	—	9GA0712P1H0011	70×70×38mm	No	✓	✓	✓	89
9GA0812H7001	—	9GA0812H7001	9GA0812H7D001	—	80×80×15mm	Yes	—	—	—	91
9GA0812P1G61	—	—	—	9GA0812P1G61	80×80×38mm	Yes	✓	✓	✓	127
9GA0812P1G611	—	—	—	9GA0812P1G611	80×80×38mm	No	✓	✓	✓	127
9GA0812P1H61	9GA0812H162	9GA0812H161	9GA0812H1D61	9GA0812P1H61	80×80×38mm	Yes	✓	✓	✓	127
9GA0812P1H611	9GA0812H1621	9GA0812H1611	—	9GA0812P1H611	80×80×38mm	No	✓	✓	✓	127
9GA0812P1S61	9GA0812S162	9GA0812S161	9GA0812S1D61	9GA0812P1S61	80×80×38mm	Yes	✓	✓	✓	127
9GA0812P1S611	9GA0812S1621	9GA0812S1611	—	9GA0812P1S611	80×80×38mm	No	✓	✓	✓	127
9GA0812P2H001	—	—	—	9GA0812P2H001	80×80×32mm	Yes	✓	✓	✓	117
9GA0812P2H0011	—	—	—	9GA0812P2H0011	80×80×32mm	No	✓	✓	✓	117
9GA0812P2M001	—	—	—	9GA0812P2M001	80×80×32mm	Yes	✓	✓	✓	117
9GA0812P2M0011	—	—	—	9GA0812P2M0011	80×80×32mm	No	✓	✓	✓	117
9GA0812P2S001	—	9GA0812S2001	—	9GA0812P2S001	80×80×32mm	Yes	✓	✓	✓	117
9GA0812P2S0011	—	—	—	9GA0812P2S0011	80×80×32mm	No	✓	✓	✓	117
9GA0812P4G001	9GA0812G4002	9GA0812G4001	—	9GA0812P4G001	80×80×25mm	Yes	✓	✓	✓	101
9GA0812P4G0011	9GA0812G40021	9GA0812G40011	—	9GA0812P4G0011	80×80×25mm	No	✓	✓	✓	101
9GA0812P4H001	9GA0812H4002	9GA0812H4001	—	9GA0812P4H001	80×80×25mm	Yes	✓	✓	✓	101
9GA0812P4H0011	9GA0812H40021	9GA0812H40011	—	9GA0812P4H0011	80×80×25mm	No	✓	✓	✓	101
9GA0812P4J001	9GA0812J4002	9GA0812J4001	9GA0812J4D001	9GA0812P4J001	80×80×25mm	Yes	✓	✓	✓	101
9GA0812P4J0011	9GA0812J40021	9GA0812J40011	—	9GA0812P4J0011	80×80×25mm	No	✓	✓	✓	101
9GA0812P6G001	9GA0812G6002	9GA0812G6001	—	9GA0812P6G001	80×80×20mm	Yes	✓	✓	✓	97
9GA0812P6M001	9GA0812M6002	9GA0812M6001	—	9GA0812P6M001	80×80×20mm	Yes	✓	✓	✓	97
9GA0812P7G001	—	—	—	9GA0812P7G001	80×80×15mm	Yes	✓	✓	✓	91
9GA0812P7S001	—	—	—	9GA0812P7S001	80×80×15mm	Yes	✓	✓	✓	91
9GA0824H7001	9GA0824H7002	9GA0824H7001	9GA0824H7D001	—	80×80×15mm	Yes	✓	✓	✓	91
9GA0824P1H61	9GA0824H162	9GA0824H161	—	9GA0824P1H61	80×80×38mm	Yes	✓	✓	✓	127
9GA0824P1H611	9GA0824H1621	9GA0824H1611	—	9GA0824P1H611	80×80×38mm	No	✓	✓	✓	127
9GA0824P1S61	9GA0824S162	9GA0824S161	—	9GA0824P1S61	80×80×38mm	Yes	✓	✓	✓	127
9GA0824P1S611	9GA0824S1621	9GA0824S1611	—	9GA0824P1S611	80×80×38mm	No	✓	✓	✓	127
9GA0824P2S001	9GA0824S2002	—	—	9GA0824P2S001	80×80×32mm	Yes	✓	✓	✓	117
9GA0824P2S0011	—	—	—	9GA0824P2S0011	80×80×32mm	No	✓	✓	✓	117
9GA0824P4G001	9GA0824G4002	9GA0824G4001	—	9GA0824P4G001	80×80×25mm	Yes	✓	✓	✓	101

Models listed in the main section of this catalog	List of models (models not listed in the main section of this catalog are options. Standards for optional model numbers may differ from the certified standards listed at right. Contact us for details of models with "-" model numbers.)				Frame Size	Rib	Standard (certification status is for the models listed in this catalog, and standards for optional model numbers may differ.)			page
	Without sensor	With pulse sensor	With lock sensor	With PWM control function and pulse sensor			UL (cUL)	CSA (cUL)	TÜV	
							✓	✓	✓	
9GA0824P4G0011	9GA0824G40021	9GA0824G40011	—	9GA0824P4G0011	80×80×25mm	No	✓	✓	✓	101
9GA0824P4H001	9GA0824H4002	9GA0824H4001	—	9GA0824P4H001	80×80×25mm	Yes	✓	✓	✓	101
9GA0824P4H0011	9GA0824H40021	9GA0824H40011	—	9GA0824P4H0011	80×80×25mm	No	✓	✓	✓	101
9GA0824P4J001	9GA0824J4002	9GA0824J4001	9GA0824J4D001	9GA0824P4J001	80×80×25mm	Yes	✓	✓	✓	101
9GA0824P4J0011	9GA0824J40021	9GA0824J40011	—	9GA0824P4J0011	80×80×25mm	No	✓	✓	✓	101
9GA0824P6G001	9GA0824G6002	9GA0824G6001	—	9GA0824P6G001	80×80×20mm	Yes	✓	✓	✓	97
9GA0824P6M001	9GA0824M6002	9GA0824M6001	—	9GA0824P6M001	80×80×20mm	Yes	✓	✓	✓	97
9GA0824P7G001	—	—	—	9GA0824P7G001	80×80×15mm	Yes	✓	✓	✓	91
9GA0824P7S001	—	—	—	9GA0824P7S001	80×80×15mm	Yes	✓	✓	✓	91
9GA0848P1S61	—	—	—	9GA0848P1S61	80×80×38mm	Yes	✓	✓	✓	127
9GA0848P1S611	—	—	—	—	80×80×38mm	No	✓	✓	✓	127
9GA0848P2S001	—	—	—	9GA0848P2S001	80×80×32mm	Yes	✓	✓	✓	117
9GA0848P2S0011	—	—	—	—	80×80×32mm	No	✓	✓	✓	117
9GA0912P1H03	9GA0912H102	9GA0912H101	9GA0912H1D01	9GA0912P1H03	92×92×38mm	Yes	✓	✓	✓	147
9GA0912P1H031	9GA0912H1021	9GA0912H1011	—	9GA0912P1H031	92×92×38mm	No	✓	✓	✓	147
9GA0912P4G03	9GA0912G402	9GA0912G401	9GA0912G4D01	9GA0912P4G03	92×92×25mm	Yes	✓	✓	✓	137
9GA0912P4G031	9GA0912G4021	9GA0912G4011	—	9GA0912P4G031	92×92×25mm	No	✓	✓	✓	137
9GA0912P4J03	9GA0912J402	9GA0912J401	9GA0912J4D01	9GA0912P4J03	92×92×25mm	Yes	✓	✓	✓	137
9GA0912P4J031	9GA0912J4021	9GA0912J4011	—	9GA0912P4J031	92×92×25mm	No	✓	✓	✓	137
9GA0912P4S03	9GA0912S402	9GA0912S401	—	9GA0912P4S03	92×92×25mm	Yes	✓	✓	✓	137
9GA0912P4S031	9GA0912S4021	9GA0912S4011	—	9GA0912P4S031	92×92×25mm	No	✓	✓	✓	137
9GA0924P1H01	9GA0924H102	9GA0924H101	9GA0924H1D01	9GA0924P1H01	92×92×38mm	Yes	✓	✓	✓	147
9GA0924P1H011	—	9GA0924H1011	9GA0924H1D011	9GA0924P1H011	92×92×38mm	No	✓	✓	✓	147
9GA0924P4G03	9GA0924G402	9GA0924G401	9GA0924G4D01	9GA0924P4G03	92×92×25mm	Yes	✓	✓	✓	137
9GA0924P4G031	9GA0924G4021	9GA0924G4011	—	9GA0924P4G031	92×92×25mm	No	✓	✓	✓	137
9GA0924P4J03	9GA0924J402	9GA0924J401	9GA0924J4D01	9GA0924P4J03	92×92×25mm	Yes	✓	✓	✓	137
9GA0924P4J031	9GA0924J4021	9GA0924J4011	—	9GA0924P4J031	92×92×25mm	No	✓	✓	✓	137
9GA0924P4S03	9GA0924S402	9GA0924S401	—	9GA0924P4S03	92×92×25mm	Yes	✓	✓	✓	137
9GA0924P4S031	9GA0924S4021	9GA0924S4011	—	9GA0924P4S031	92×92×25mm	No	✓	✓	✓	137
9GA0948P1H03	9GA0948H102	9GA0948H101	—	9GA0948P1H03	92×92×38mm	Yes	✓	✓	✓	147
9GA0948P1H031	—	—	—	9GA0948P1H031	92×92×38mm	No	✓	✓	✓	147
9GAX0412P3K001	—	—	—	9GAX0412P3K001	40×40×28mm	Yes	✓	✓	✓	33
9GAX0412P3K0011	—	—	—	9GAX0412P3K0011	40×40×28mm	No	✓	✓	✓	33
9GAX0412P3K003	—	—	—	9GAX0412P3K003	40×40×28mm	Yes	✓	✓	✓	33
9GAX0412P3K0031	—	—	—	9GAX0412P3K0031	40×40×28mm	No	✓	✓	✓	33
9GAX0412P3S001	—	—	—	9GAX0412P3S001	40×40×28mm	Yes	✓	✓	✓	33
9GAX0412P3S0011	—	—	—	9GAX0412P3S0011	40×40×28mm	No	✓	✓	✓	33
9GAX0412P3S003	—	—	—	9GAX0412P3S003	40×40×28mm	Yes	✓	✓	✓	33
9GAX0412P3S0031	—	—	—	9GAX0412P3S0031	40×40×28mm	No	✓	✓	✓	33
9GE0412P3G03	—	—	9GE0412G3D01	9GE0412P3G03	40×40×28mm	No	✓	✓	✓	39
9GE0412P3J03	—	9GE0412J301	9GE0412J3D01	9GE0412P3J03	40×40×28mm	No	✓	✓	✓	39
9GE0412P3K03	—	9GE0412K301	9GE0412K3D01	9GE0412P3K03	40×40×28mm	No	✓	✓	✓	39
9GL1212E101	9GL1212E102	9GL1212E101	9GL1212E1D01	—	120×120×38mm	No	✓	✓	✓	345
9GL1212F101	9GL1212F102	9GL1212F101	9GL1212F1D01	—	120×120×38mm	No	✓	✓	✓	345
9GL1212G101	9GL1212G102	9GL1212G101	9GL1212G1D01	—	120×120×38mm	No	✓	✓	✓	345
9GL1212H101	9GL1212H102	9GL1212H101	9GL1212H1D01	—	120×120×38mm	No	✓	✓	✓	345
9GL1212M101	9GL1212M102	9GL1212M101	9GL1212M1D01	—	120×120×38mm	No	✓	✓	✓	345
9GL1224E101	9GL1224E102	9GL1224E101	9GL1224E1D01	—	120×120×38mm	No	✓	✓	✓	345
9GL1224F101	9GL1224F102	9GL1224F101	9GL1224F1D01	—	120×120×38mm	No	✓	✓	✓	345
9GL1224G101	9GL1224G102	9GL1224G101	9GL1224G1D01	—	120×120×38mm	No	✓	✓	✓	345
9GL1224H101	9GL1224H102	9GL1224H101	9GL1224H1D01	—	120×120×38mm	No	✓	✓	✓	345
9GL1224M101	9GL1224M102	9GL1224M101	9GL1224M1D01	—	120×120×38mm	No	✓	✓	✓	345
9GL1248E101	9GL1248E102	9GL1248E101	9GL1248E1D01	—	120×120×38mm	No	✓	✓	✓	345
9GL1248F101	9GL1248F102	9GL1248F101	9GL1248F1D01	—	120×120×38mm	No	✓	✓	✓	345
9GL1248G101	9GL1248G102	9GL1248G101	9GL1248G1D01	—	120×120×38mm	No	✓	✓	✓	345
9GL1248H101	9GL1248H102	9GL1248H101	9GL1248H1D01	—	120×120×38mm	No	✓	✓	✓	345
9GL1248M101	9GL1248M102	9GL1248M101	9GL1248M1D01	—	120×120×38mm	No	✓	✓	✓	345
9GT0412P3J001	9GT0412J3002	9GT0412J3001	9GT0412J3D001	9GT0412P3J001	40×40×28mm	No	✓	✓	✓	359
9GT0424P3J001	9GT0424J3002	9GT0424J3001	9GT0424J3D001	9GT0424P3J001	40×40×28mm	No	✓	✓	✓	359
9GT0612P4G001	9GT0612G4002	9GT0612G4001	9GT0612G4D001	9GT0612P4G001	60×60×25mm	No	✓	✓	✓	361
9GT0624P4G001	9GT0624G4002	9GT0624G4001	—	9GT0624P4G001	60×60×25mm	No	✓	✓	✓	361
9GT0812P4S001	9GT0812S4002	9GT0812S4001	9GT0812S4D001	9GT0812P4S001	80×80×25mm	No	✓	✓	✓	363

Please contact your point of sale regarding low-speed sensors.

Models listed in the main section of this catalog	List of models (models not listed in the main section of this catalog are options. Standards for optional model numbers may differ from the certified standards listed at right. Contact us for details of models with "-" model numbers.)				Frame Size	Rib	Standard (certification status is for the models listed in this catalog, and standards for optional model numbers may differ.)			page
	Without sensor	With pulse sensor	With lock sensor	With PWM control function and pulse sensor			UL (cUL)	CSA (cUL)	TÜV	
							✓	✓	✓	
9GT0824P4S001	9GT0824S4002	9GT0824S4001	—	9GT0824P4S001	80×80×25mm	No	✓	✓	✓	363
9GT0912P1M001	9GT0912M1002	9GT0912M1001	9GT0912M1D001	9GT0912P1M001	92×92×38mm	No	✓	✓	✓	367
9GT0912P4J001	9GT0912J4002	9GT0912J4001	9GT0912J4D001	9GT0912P4J001	92×92×25mm	No	✓	✓	✓	365
9GT0924P1M001	9GT0924M1002	—	—	9GT0924P1M001	92×92×38mm	No	✓	✓	✓	367
9GT0924P4J001	9GT0924J4002	9GT0924J4001	—	9GT0924P4J001	92×92×25mm	No	✓	✓	✓	365
9GT1212P1S001	—	—	—	9GT1212P1S001	120×120×38mm	No	✓	✓	✓	369
9GT1224P1S001	9GT1224S1002	—	9GT1224S1D001	9GT1224P1S001	120×120×38mm	No	✓	✓	✓	369
9GV0312E301	9GV0312E302	9GV0312E301	9GV0312E3D01	—	38×38×28mm	Yes	✓	✓	✓	15
9GV0312E3011	—	9GV0312E3011	9GV0312E3D011	—	38×38×28mm	No	✓	✓	✓	15
9GV0312G301	9GV0312G302	9GV0312G301	9GV0312G3D01	9GV0312P3G03	38×38×28mm	Yes	✓	✓	✓	15
9GV0312G3011	9GV0312G3021	9GV0312G3011	—	—	38×38×28mm	No	✓	✓	✓	15
9GV0312H301	9GV0312H302	9GV0312H301	—	—	38×38×28mm	Yes	✓	✓	✓	15
9GV0312H3011	—	9GV0312H3011	—	—	38×38×28mm	No	✓	✓	✓	15
9GV0312J301	9GV0312J302	9GV0312J301	9GV0312J3D01	9GV0312P3J03	38×38×28mm	Yes	✓	✓	✓	15
9GV0312J3011	9GV0312J3021	9GV0312J3011	—	9GV0312P3J031	38×38×28mm	No	✓	✓	✓	15
9GV0312K301	—	9GV0312K301	9GV0312K3D01	9GV0312P3K01	38×38×28mm	Yes	✓	✓	✓	15
9GV0312K3011	—	9GV0312K3011	—	—	38×38×28mm	No	✓	✓	✓	15
9GV0412C301	—	9GV0412C301	9GV0412C3D01	—	40×40×28mm	Yes	✓	✓	✓	41
9GV0412C3011	—	9GV0412C3011	9GV0412C3D011	—	40×40×28mm	No	✓	✓	✓	41
9GV0412G301	9GV0412G302	9GV0412G301	9GV0412G3D01	9GV0412P3G03	40×40×28mm	Yes	✓	✓	✓	41
9GV0412G3011	9GV0412G3021	9GV0412G3011	9GV0412G3D011	9GV0412P3G031	40×40×28mm	No	✓	✓	✓	41
9GV0412H301	—	9GV0412H301	9GV0412H3D01	9GV0412P3H01	40×40×28mm	Yes	✓	✓	✓	41
9GV0412H3011	—	9GV0412H3011	—	—	40×40×28mm	No	✓	✓	✓	41
9GV0412J301	9GV0412J302	9GV0412J301	9GV0412J3D01	9GV0412P3J03	40×40×28mm	Yes	✓	✓	✓	41
9GV0412J3011	9GV0412J3021	9GV0412J3011	9GV0412J3D011	9GV0412P3J031	40×40×28mm	No	✓	✓	✓	41
9GV0412K301	9GV0412K302	9GV0412K301	9GV0412K3D01	9GV0412P3K03	40×40×28mm	Yes	✓	✓	✓	41
9GV0412K3011	—	9GV0412K3011	—	—	40×40×28mm	No	✓	✓	✓	41
9GV0612P1G03	9GV0612G102	9GV0612G101	9GV0612G1D01	9GV0612P1G03	60×60×38mm	Yes	✓	✓	✓	83
9GV0612P1G031	9GV0612G1021	9GV0612G1011	9GV0612G1D011	9GV0612P1G031	60×60×38mm	No	✓	✓	✓	83
9GV0612P1H03	9GV0612H102	9GV0612H101	9GV0612H1D01	9GV0612P1H03	60×60×38mm	Yes	✓	✓	✓	83
9GV0612P1H031	9GV0612H1021	9GV0612H1011	9GV0612H1D011	9GV0612P1H031	60×60×38mm	No	✓	✓	✓	83
9GV0612P1L01	9GV0612L102	—	—	9GV0612P1L01	60×60×38mm	Yes	✓	✓	✓	83
9GV0612P1L011	9GV0612L1021	9GV0612L1011	9GV0612L1D011	9GV0612P1L011	60×60×38mm	No	✓	✓	✓	83
9GV0612P1M03	—	9GV0612M101	9GV0612M1D01	9GV0612P1M03	60×60×38mm	Yes	✓	✓	✓	83
9GV0612P1M031	—	9GV0612M1011	9GV0612M1D011	9GV0612P1M031	60×60×38mm	No	✓	✓	✓	83
9GV0624P1G03	9GV0624G102	—	9GV0624G1D01	9GV0624P1G03	60×60×38mm	Yes	✓	✓	✓	83
9GV0624P1G031	9GV0624G1021	—	—	9GV0624P1G031	60×60×38mm	No	✓	✓	✓	83
9GV0624P1M03	9GV0624M102	9GV0624M101	—	9GV0624P1M03	60×60×38mm	Yes	✓	✓	✓	83
9GV0624P1M031	—	—	—	9GV0624P1M031	60×60×38mm	No	✓	✓	✓	83
9GV0648P1H03	—	—	—	9GV0648P1H03	60×60×38mm	Yes	✓	✓	✓	83
9GV0648P1H031	—	—	—	9GV0648P1H031	60×60×38mm	No	✓	✓	✓	83
9GV0812P1F03	—	—	—	9GV0812P1F03	80×80×38mm	Yes	✓	✓	✓	131
9GV0812P1F031	—	—	—	9GV0812P1F031	80×80×38mm	No	✓	✓	✓	131
9GV0812P1G03	9GV0812G102	9GV0812G101	—	9GV0812P1G03	80×80×38mm	Yes	✓	✓	✓	131
9GV0812P1G031	9GV0812G1021	9GV0812G1011	—	9GV0812P1G031	80×80×38mm	No	✓	✓	✓	131
9GV0812P1H03	9GV0812H102	9GV0812H101	—	9GV0812P1H03	80×80×38mm	Yes	✓	✓	✓	131
9GV0812P1H031	9GV0812H1021	9GV0812H1011	—	9GV0812P1H031	80×80×38mm	No	✓	✓	✓	131
9GV0812P1M03	—	—	—	9GV0812P1M03	80×80×38mm	Yes	✓	✓	✓	131
9GV0812P1M031	—	—	—	9GV0812P1M031	80×80×38mm	No	✓	✓	✓	131
9GV0812P4J03	9GV0812J402	9GV0812J401	—	9GV0812P4J03	80×80×25mm	Yes	✓	✓	✓	107
9GV0812P4J031	9GV0812J4021	9GV0812J4011	—	9GV0812P4J031	80×80×25mm	No	✓	✓	✓	107
9GV0812P4K03	—	9GV0812K401	9GV0812K4D01	9GV0812P4K03	80×80×25mm	Yes	✓	✓	✓	107
9GV0812P4K031	9GV0812K4021	9GV0812K4011	9GV0812K4D011	9GV0812P4K031	80×80×25mm	No	✓	✓	✓	107
9GV0824P1G03	9GV0824G102	9GV0824G101	—	9GV0824P1G03	80×80×38mm	Yes	✓	✓	✓	131
9GV0824P1G031	—	—	—	9GV0824P1G031	80×80×38mm	No	✓	✓	✓	131
9GV0824P4K01	9GV0824K402	9GV0824K401	—	9GV0824P4K01	80×80×25mm	Yes	✓	✓	✓	107
9GV0824P4K011	—	—	—	9GV0824P4K011	80×80×25mm	No	✓	✓	✓	107
9GV0848P1G03	9GV0848G102	9GV0848G101	—	9GV0848P1G03	80×80×38mm	Yes	✓	✓	✓	131
9GV0848P1G031	—	9GV0848G1011	—	9GV0848P1G031	80×80×38mm	No	✓	✓	✓	131
9GV0848P4K03	—	9GV0848K401	—	9GV0848P4K03	80×80×25mm	Yes	✓	✓	✓	107
9GV0848P4K031	—	—	—	9GV0848P4K031	80×80×25mm	No	✓	✓	✓	107
9GV0912P1F03	—	—	—	9GV0912P1F03	92×92×38mm	Yes	✓	✓	✓	151

Models listed in the main section of this catalog	List of models (models not listed in the main section of this catalog are options. Standards for optional model numbers may differ from the certified standards listed at right. Contact us for details of models with "-" model numbers.)				Frame Size	Rib	Standard (certification status is for the models listed in this catalog, and standards for optional model numbers may differ.)			page
	Without sensor	With pulse sensor	With lock sensor	With PWM control function and pulse sensor			UL (cUL)	CSA (cUL)	TÜV	
							✓	✓	✓	
9GV0912P1F031	—	—	—	9GV0912P1F031	92×92×38mm	No	✓	✓	✓	151
9GV0912P1G03	—	—	—	9GV0912P1G03	92×92×38mm	Yes	✓	✓	✓	151
9GV0912P1G031	—	—	—	9GV0912P1G031	92×92×38mm	No	✓	✓	✓	151
9GV0912P1H03	9GV0912H102	—	9GV0912H1D01	9GV0912P1H03	92×92×38mm	Yes	✓	✓	✓	151
9GV0912P1H031	—	—	—	9GV0912P1H031	92×92×38mm	No	✓	✓	✓	151
9GV0948P1F03	—	—	—	9GV0948P1F03	92×92×38mm	Yes	✓	✓	✓	151
9GV0948P1F031	—	—	—	9GV0948P1F031	92×92×38mm	No	✓	✓	✓	151
9GV0948P1H03	9GV0948H102	9GV0948H101	—	9GV0948P1H03	92×92×38mm	Yes	✓	✓	✓	151
9GV0948P1H031	9GV0948H1021	—	—	9GV0948P1H031	92×92×38mm	No	✓	✓	✓	151
9GV1212P1G01	—	—	—	9GV1212P1G01	120×120×38mm	Yes	✓	✓	✓	169
9GV1212P1G011	—	9GV1212G1011	—	9GV1212P1G011	120×120×38mm	No	✓	✓	✓	169
9GV1212P1J01	9GV1212J102	9GV1212J101	—	9GV1212P1J01	120×120×38mm	Yes	✓	✓	✓	169
9GV1212P1J011	9GV1212J1021	9GV1212J1011	—	9GV1212P1J011	120×120×38mm	No	✓	✓	✓	169
9GV1212P4G01	9GV1212G402	9GV1212G401	—	9GV1212P4G01	120×120×25mm	Yes	✓	✓	✓	159
9GV1212P4G011	9GV1212G4021	9GV1212G4011	—	9GV1212P4G011	120×120×25mm	No	✓	✓	✓	159
9GV1224P1H01	9GV1224H102	9GV1224H101	9GV1224H1D01	9GV1224P1H01	120×120×38mm	Yes	✓	✓	✓	169
9GV1224P1H011	9GV1224H1021	9GV1224H1011	9GV1224H1D011	9GV1224P1H011	120×120×38mm	No	✓	✓	✓	169
9GV1224P1J01	9GV1224J102	9GV1224J101	9GV1224J1D01	9GV1224P1J01	120×120×38mm	Yes	✓	✓	✓	169
9GV1224P1J011	9GV1224J1021	9GV1224J1011	9GV1224J1D011	9GV1224P1J011	120×120×38mm	No	✓	✓	✓	169
9GV1224P4G01	9GV1224G402	9GV1224G401	9GV1224G4D01	9GV1224P4G01	120×120×25mm	Yes	✓	✓	✓	159
9GV1224P4G011	9GV1224G4021	—	—	9GV1224P4G011	120×120×25mm	No	✓	✓	✓	159
9GV1248P1J01	9GV1248J102	9GV1248J101	9GV1248J1D01	9GV1248P1J01	120×120×38mm	Yes	✓	✓	✓	169
9GV1248P1J011	9GV1248J1021	9GV1248J1011	—	9GV1248P1J011	120×120×38mm	No	✓	✓	✓	169
9GV1248P4G01	9GV1248G402	9GV1248G401	—	9GV1248P4G01	120×120×25mm	Yes	✓	✓	✓	159
9GV1248P4G011	—	9GV1248G4011	—	9GV1248P4G011	120×120×25mm	No	✓	✓	✓	159
9GV1248P4H01	9GV1248H402	9GV1248H401	—	9GV1248P4H01	120×120×25mm	Yes	✓	✓	✓	159
9GV1248P4H011	—	—	—	9GV1248P4H011	120×120×25mm	No	✓	✓	✓	159
9GV1248P4J01	—	—	—	9GV1248P4J01	120×120×25mm	Yes	✓	✓	✓	159
9GV1248P4J011	—	—	—	9GV1248P4J011	120×120×25mm	No	✓	✓	✓	159
9GV1412P1G001	—	—	—	9GV1412P1G001	140×140×38mm	No	✓	✓	✓	183
9GV1412P1H001	—	—	—	9GV1412P1H001	140×140×38mm	No	✓	✓	✓	183
9GV1412P1S001	—	—	—	9GV1412P1S001	140×140×38mm	No	✓	✓	✓	183
9GV1424P1G001	—	—	—	9GV1424P1G001	140×140×38mm	No	✓	✓	✓	183
9GV1424P1H001	—	—	—	9GV1424P1H001	140×140×38mm	No	✓	✓	✓	183
9GV1424P1S001	—	—	—	9GV1424P1S001	140×140×38mm	No	✓	✓	✓	183
9GV1448P1G001	—	—	—	9GV1448P1G001	140×140×38mm	No	✓	✓	✓	183
9GV1448P1H001	—	—	—	9GV1448P1H001	140×140×38mm	No	✓	✓	✓	183
9GV1448P1S001	—	—	—	9GV1448P1S001	140×140×38mm	No	✓	✓	✓	183
9GV1512H501	9GV1512H502	9GV1512H501	—	9GV1512P5H03	150×150×50mm	Yes	✓	✓	✓	189
9GV1512H5011	9GV1512H5021	9GV1512H5011	—	—	150×150×50mm	No	✓	✓	✓	189
9GV1512M501	9GV1512M502	9GV1512M501	—	9GV1512P5M03	150×150×50mm	Yes	✓	✓	✓	189
9GV1512M5011	9GV1512M5021	9GV1512M5011	—	—	150×150×50mm	No	✓	✓	✓	189
9GV1524M501	9GV1524M502	9GV1524M501	9GV1524M5D01	—	150×150×50mm	Yes	✓	✓	✓	189
9GV1524M5011	—	9GV1524M5011	—	—	150×150×50mm	No	✓	✓	✓	189
9GV2048P0G201	9GV2048G0202	—	—	9GV2048P0G201	φ200mm×70mm	No	✓	✓	✓	203
9GV3612G301	9GV3612G302	9GV3612G301	9GV3612G3D01	9GV3612P3G03	36×36×28mm	Yes	✓	✓	✓	11
9GV3612J301	9GV3612J302	9GV3612J301	9GV3612J3D01	9GV3612P3J03	36×36×28mm	Yes	✓	✓	✓	11
9GV5724H501	9GV5724H502	9GV5724H501	—	9GV5724P5H03	φ172mm×150mm×51mm	No	✓	✓	✓	197
9GV5748H501	9GV5748H502	9GV5748H501	—	9GV5748P5H01	φ172mm×150mm×51mm	No	✓	✓	✓	197
9GX3612P3K001	—	—	—	9GX3612P3K001	36×36×28mm	Yes	✓	✓	✓	11
9HV0412P3K001	—	—	—	9HV0412P3K001	40×40×28mm	No	✓	✓	✓	31
9HV0612P1J001	—	—	—	9HV0612P1J001	60×60×38mm	Yes	✓	✓	✓	77
9HV0612P1J0011	—	—	—	9HV0612P1J0011	60×60×38mm	No	✓	✓	✓	77
9HV0812P1G001	9HV0812G1002	9HV0812G1001	—	9HV0812P1G001	80×80×38mm	Yes	✓	✓	✓	125
9HV0812P1G0011	9HV0812G10021	9HV0812G10011	—	9HV0812P1G0011	80×80×38mm	No	✓	✓	✓	125
9HV0824P1G003	—	—	9HV0824G1D001	9HV0824P1G003	80×80×38mm	Yes	✓	✓	✓	125
9HV0824P1G0011	—	—	—	9HV0824P1G0011	80×80×38mm	No	✓	✓	✓	125
9HV0848P1G001	9HV0848G1002	9HV0848G1001	9HV0848G1D001	9HV0848P1G001	80×80×38mm	Yes	✓	✓	✓	125
9HV0848P1G0011	9HV0848G10021	9HV0848G10011	—	9HV0848P1G0011	80×80×38mm	No	✓	✓	✓	125
9HV0912P1G001	—	—	—	9HV0912P1G001	92×92×38mm	Yes	✓	✓	✓	149
9HV0912P1G0011	—	—	—	9HV0912P1G0011	92×92×38mm	No	✓	✓	✓	149
9HV0948P1G001	—	—	—	9HV0948P1G001	92×92×38mm	Yes	✓	✓	✓	149

Please contact your point of sale regarding low-speed sensors.

Models listed in the main section of this catalog	List of models (models not listed in the main section of this catalog are options. Standards for optional model numbers may differ from the certified standards listed at right. Contact us for details of models with "-" model numbers.)				Frame Size	Rib	Standard (certification status is for the models listed in this catalog, and standards for optional model numbers may differ.)			page
	Without sensor	With pulse sensor	With lock sensor	With PWM control function and pulse sensor			UL (cUL)	CSA (cUL)	TÜV	
							✓	✓	✓	
9HV0948P1G0011	—	—	—	9HV0948P1G0011	92×92×38mm	No	✓	✓	✓	149
9HV1224P1A001	—	—	—	9HV1224P1A001	120×120×38mm	No	✓	✓	✓	167
9HV1248P1G001	9HV1248G1002	9HV1248G1001	—	9HV1248P1G001	120×120×38mm	No	✓	✓	✓	167
9HV1248P1H001	9HV1248H1002	9HV1248H1001	—	9HV1248P1H001	120×120×38mm	No	✓	✓	✓	167
9HV5724P5H001	—	—	9HV5724H5D001	9HV5724P5H001	φ172mm×150mm×51mm	No	✓	✓	✓	193
9HV5748P5G001	—	—	—	9HV5748P5G001	φ172mm×150mm×51mm	No	✓	✓	✓	193
9HVA0812P1G001	—	—	—	9HVA0812P1G001	80×80×38mm	Yes	✓	✓	✓	123
9HVA0812P1G0011	—	—	—	9HVA0812P1G0011	80×80×38mm	No	✓	✓	✓	123
9L0412H301	9L0412H302	9L0412H301	9L0412H3D01	—	40×40×28mm	No	✓	✓	✓	319
9L0412J301	9L0412J302	9L0412J301	9L0412J3D01	9L0412P3J01	40×40×28mm	No	✓	✓	✓	319
9L0412M301	9L0412M302	9L0412M301	9L0412M3D01	—	40×40×28mm	No	✓	✓	✓	319
9LB1412H501	9LB1412H502	9LB1412H501	9LB1412H5D01	—	140×140×51mm	No	✓	✓	✓	351
9LB1412M501	9LB1412M502	9LB1412M501	9LB1412M5D01	—	140×140×51mm	No	✓	✓	✓	351
9LB1412S501	9LB1412S502	9LB1412S501	9LB1412S5D01	—	140×140×51mm	No	✓	✓	✓	351
9LB1424B501	9LB1424B502	9LB1424B501	—	—	140×140×51mm	No	—	—	—	351
9LB1424H501	9LB1424H502	9LB1424H501	9LB1424H5D01	—	140×140×51mm	No	✓	✓	✓	351
9LB1424M501	9LB1424M502	9LB1424M501	9LB1424M5D01	—	140×140×51mm	No	✓	✓	✓	351
9LB1424S501	9LB1424S502	9LB1424S501	9LB1424S5D01	—	140×140×51mm	No	✓	✓	✓	351
9LB1448F501	—	9LB1448F501	—	—	140×140×51mm	No	—	—	—	351
9LB1448H501	9LB1448H502	9LB1448H501	9LB1448H5D01	—	140×140×51mm	No	✓	✓	✓	351
9LB1448M501	9LB1448M502	9LB1448M501	9LB1448M5D01	—	140×140×51mm	No	✓	✓	✓	351
9LB1448S501	9LB1448S502	9LB1448S501	9LB1448S5D01	—	140×140×51mm	No	✓	✓	✓	351
9LG0612P4H001	—	9LG0612H4001	9LG0612H4D001	9LG0612P4H001	60×60×25mm	No	✓	✓	✓	321
9LG0612P4J001	—	—	9LG0612J4D001	9LG0612P4J001	60×60×25mm	No	✓	✓	✓	321
9LG0612P4M001	—	9LG0624M4001	9LG0612M4D001	9LG0612P4M001	60×60×25mm	No	✓	✓	✓	321
9LG0612P4S001	—	9LG0612S4001	—	9LG0612P4S001	60×60×25mm	No	✓	✓	✓	321
9LG0624P4H001	—	—	—	9LG0624P4H001	60×60×25mm	No	✓	✓	✓	321
9LG0624P4J001	—	—	—	9LG0624P4J001	60×60×25mm	No	✓	✓	✓	321
9LG0624P4M001	—	9LG0624M4001	—	9LG0624P4M001	60×60×25mm	No	✓	✓	✓	321
9LG0624P4S001	—	—	—	9LG0624P4S001	60×60×25mm	No	✓	✓	✓	321
9LG0648P4H001	—	—	—	9LG0648P4H001	60×60×25mm	No	✓	✓	✓	321
9LG0648P4J001	—	—	—	9LG0648P4J001	60×60×25mm	No	✓	✓	✓	321
9LG0648P4M001	—	—	—	9LG0648P4M001	60×60×25mm	No	✓	✓	✓	321
9LG0648P4S001	—	—	—	9LG0648P4S001	60×60×25mm	No	✓	✓	✓	321
9LG0812P4G001	—	—	—	9LG0812P4G001	80×80×25mm	No	✓	✓	✓	329
9LG0812P4H001	—	—	—	9LG0812P4H001	80×80×25mm	No	✓	✓	✓	329
9LG0812P4J001	—	—	9LG0812J4D001	9LG0812P4J001	80×80×25mm	No	✓	✓	✓	329
9LG0824P4G001	9LG0824G4002	—	9LG0824G4D001	9LG0824P4G001	80×80×25mm	No	✓	✓	✓	329
9LG0824P4H001	—	—	—	9LG0824P4H001	80×80×25mm	No	✓	✓	✓	329
9LG0824P4J001	—	—	9LG0824J4D001	9LG0824P4J001	80×80×25mm	No	✓	✓	✓	329
9LG0912P1F001	—	—	—	9LG0912P1F001	92×92×38mm	No	✓	✓	✓	339
9LG0912P1H001	—	—	—	9LG0912P1H001	92×92×38mm	No	✓	✓	✓	339
9LG0912P4G001	9LG0912G4002	—	—	9LG0912P4G001	92×92×25mm	No	✓	✓	✓	335
9LG0912P4H001	—	—	—	9LG0912P4H001	92×92×25mm	No	✓	✓	✓	335
9LG0912P4J001	—	—	—	9LG0912P4J001	92×92×25mm	No	✓	✓	✓	335
9LG0912P4S001	—	—	—	9LG0912P4S001	92×92×25mm	No	✓	✓	✓	335
9LG0924P1F001	—	—	—	9LG0924P1F001	92×92×38mm	No	✓	✓	✓	339
9LG0924P1H001	—	—	—	9LG0924P1H001	92×92×38mm	No	✓	✓	✓	339
9LG0924P4G001	—	—	—	9LG0924P4G001	92×92×25mm	No	✓	✓	✓	335
9LG0924P4H001	—	—	—	9LG0924P4H001	92×92×25mm	No	✓	✓	✓	335
9LG0924P4J001	—	—	9LG0924J4D001	9LG0924P4J001	92×92×25mm	No	✓	✓	✓	335
9LG0924P4S001	—	—	9LG0924S4D001	9LG0924P4S001	92×92×25mm	No	✓	✓	✓	335
9LG1212P1G001	—	—	—	9LG1212P1G001	120×120×38mm	No	✓	✓	✓	341
9LG1212P1H001	—	—	—	9LG1212P1H001	120×120×38mm	No	✓	✓	✓	341
9LG1212P1S001	—	—	—	9LG1212P1S001	120×120×38mm	No	✓	✓	✓	341
9LG1224P1G001	—	—	9LG1224G1D001	9LG1224P1G001	120×120×38mm	No	✓	✓	✓	341
9LG1224P1H001	—	—	9LG1224H1D001	9LG1224P1H001	120×120×38mm	No	✓	✓	✓	341
9LG1224P1S001	—	9LG1224S1001	9LG1224S1D001	9LG1224P1S001	120×120×38mm	No	✓	✓	✓	341
9LG1248P1G001	9LG1248G1002	—	—	9LG1248P1G001	120×120×38mm	No	✓	✓	✓	341
9LG1248P1H001	—	—	—	9LG1248P1H001	120×120×38mm	No	✓	✓	✓	341
9LG1248P1S001	—	—	—	9LG1248P1S001	120×120×38mm	No	✓	✓	✓	341
9RF1312P3H001	—	—	—	9RF1312P3H001	φ136mm×28mm	No	✓	✓	✓	243

Models listed in the main section of this catalog	List of models (models not listed in the main section of this catalog are options. Standards for optional model numbers may differ from the certified standards listed at right. Contact us for details of models with "-" model numbers.)				Frame Size	Rib	Standard (certification status is for the models listed in this catalog, and standards for optional model numbers may differ.)			page
	Without sensor	With pulse sensor	With lock sensor	With PWM control function and pulse sensor			UL (cUL)	CSA (cUL)	TÜV	
							✓	✓	✓	
9RF1324P3H001	—	—	—	9RF1324P3H001	φ 136mm × 28mm	No	✓	✓	✓	243
9S0612F401	9S0612F402	9S0612F401	9S0612F4D01	9S0612P4F01	60 × 60 × 25mm	Yes	✓	✓	✓	67
9S0612F4011	9S0612F4021	9S0612F4011	9S0612F4D011	9S0612P4F011	60 × 60 × 25mm	No	✓	✓	✓	67
9S0612H401	9S0612H402	9S0612H401	9S0612H4D01	9S0612P4H01	60 × 60 × 25mm	Yes	✓	✓	✓	67
9S0612H4011	9S0612H4021	9S0612H4011	9S0612H4D011	9S0612P4H011	60 × 60 × 25mm	No	✓	✓	✓	67
9S0612M401	9S0612M402	9S0612M401	9S0612M4D01	9S0612P4M01	60 × 60 × 25mm	Yes	✓	✓	✓	67
9S0612M4011	9S0612M4021	9S0612M4011	9S0612M4D011	—	60 × 60 × 25mm	No	✓	✓	✓	67
9S0612S401	9S0612S402	9S0612S401	9S0612S4D01	9S0612P4S01	60 × 60 × 25mm	Yes	✓	✓	✓	67
9S0612S4011	—	9S0612S4011	—	—	60 × 60 × 25mm	No	✓	✓	✓	67
9S0812F401	9S0812F402	9S0812F401	9S0812F4D01	9S0812P4F01	80 × 80 × 25mm	Yes	✓	✓	✓	105
9S0812F4011	9S0812F4021	9S0812F4011	9S0812F4D011	9S0812P4F011	80 × 80 × 25mm	No	✓	✓	✓	105
9S0812H401	9S0812H402	9S0812H401	9S0812H4D01	—	80 × 80 × 25mm	Yes	✓	✓	—	105
9S0812H4011	—	9S0812H4011	9S0812H4D011	—	80 × 80 × 25mm	No	✓	✓	—	105
9S0812L401	9S0812L402	9S0812L401	9S0812L4D01	—	80 × 80 × 25mm	Yes	✓	✓	✓	105
9S0812L4011	9S0812L4021	9S0812L4011	9S0812L4D011	—	80 × 80 × 25mm	No	✓	✓	✓	105
9S0812M401	9S0812M402	9S0812M401	9S0812M4D01	9S0812P4M01	80 × 80 × 25mm	Yes	✓	✓	✓	105
9S0812M4011	9S0812M4021	9S0812M4011	9S0812M4D011	9S0812P4M011	80 × 80 × 25mm	No	✓	✓	✓	105
9S0824L401	9S0824L402	9S0824L401	9S0824L4D01	—	80 × 80 × 25mm	Yes	✓	✓	✓	105
9S0824L4011	9S0824L4021	9S0824L4011	9S0824L4D011	—	80 × 80 × 25mm	No	✓	✓	✓	105
9S0824M401	9S0824M402	9S0824M401	9S0824M4D01	—	80 × 80 × 25mm	Yes	✓	✓	✓	105
9S0824M4011	9S0824M4021	9S0824M4011	9S0824M4D011	—	80 × 80 × 25mm	No	✓	✓	✓	105
9S0912F401	9S0912F402	9S0912F401	9S0912F4D01	9S0912P4F01	92 × 92 × 25mm	Yes	✓	✓	✓	141
9S0912F4011	9S0912F4021	9S0912F4011	9S0912F4D011	9S0912P4F011	92 × 92 × 25mm	No	✓	✓	✓	141
9S0912L401	9S0912L402	9S0912L401	9S0912L4D01	—	92 × 92 × 25mm	Yes	✓	✓	✓	141
9S0912L4011	9S0912L4021	9S0912L4011	9S0912L4D011	—	92 × 92 × 25mm	No	✓	✓	✓	141
9S0912M401	9S0912M402	9S0912M401	9S0912M4D01	9S0912P4M01	92 × 92 × 25mm	Yes	✓	✓	✓	141
9S0912M4011	9S0912M4021	9S0912M4011	9S0912M4D011	9S0912P4M011	92 × 92 × 25mm	No	✓	✓	✓	141
9S0924F401	9S0924F402	9S0924F401	9S0924F4D01	—	92 × 92 × 25mm	Yes	✓	✓	✓	141
9S0924F4011	9S0924F4021	9S0924F4011	—	—	92 × 92 × 25mm	No	✓	✓	✓	141
9S0924L401	9S0924L402	9S0924L401	9S0924L4D01	—	92 × 92 × 25mm	Yes	✓	✓	✓	141
9S0924L4011	9S0924L4021	9S0924L4011	—	—	92 × 92 × 25mm	No	✓	✓	✓	141
9S0924M401	9S0924M402	9S0924M401	9S0924M4D01	—	92 × 92 × 25mm	Yes	✓	✓	✓	141
9S0924M4011	9S0924M4021	9S0924M4011	—	—	92 × 92 × 25mm	No	✓	✓	✓	141
9S1212F401	9S1212F402	9S1212F401	9S1212F4D01	9S1212P4F01	120 × 120 × 25mm	Yes	✓	✓	✓	157
9S1212F4011	9S1212F4021	9S1212F4011	9S1212F4D011	9S1212P4F011	120 × 120 × 25mm	No	✓	✓	✓	157
9S1212H401	9S1212H402	9S1212H401	9S1212H4D01	9S1212P4H01	120 × 120 × 25mm	Yes	✓	✓	✓	157
9S1212H4011	9S1212H4021	9S1212H4011	—	9S1212P4H011	120 × 120 × 25mm	No	✓	✓	✓	157
9S1212L401	9S1212L402	9S1212L401	9S1212L4D01	—	120 × 120 × 25mm	Yes	✓	✓	✓	157
9S1212L4011	9S1212L4021	9S1212L4011	9S1212L4D011	9S1212P4L011	120 × 120 × 25mm	No	✓	✓	✓	157
9S1212M401	9S1212M402	9S1212M401	9S1212M4D01	9S1212P4M01	120 × 120 × 25mm	Yes	✓	✓	✓	157
9S1212M4011	9S1212M4021	9S1212M4011	9S1212M4D011	9S1212P4M011	120 × 120 × 25mm	No	✓	✓	✓	157
9S1224M401	9S1224M402	9S1224M401	9S1224M4D01	—	120 × 120 × 25mm	Yes	✓	✓	✓	157
9S1224M4011	9S1224M4021	9S1224M4011	9S1224M4D011	—	120 × 120 × 25mm	No	✓	✓	✓	157
9SG1212G101	9SG1212G102	9SG1212G101	9SG1212G1D01	9SG1212P1G01	120 × 120 × 38mm	No	✓	✓	✓	177
9SG1224G101	9SG1224G102	9SG1224G101	9SG1224G1D01	9SG1224P1G01	120 × 120 × 38mm	No	✓	✓	✓	177
9SG1224H101	9SG1224H102	9SG1224H101	9SG1224H1D01	—	120 × 120 × 38mm	No	—	—	—	177
9SG1248G101	9SG1248G102	9SG1248G101	—	9SG1248P1G01	120 × 120 × 38mm	No	✓	✓	✓	177
9SG5724P5H61	9SG5724H562	—	—	9SG5724P5H61	φ 172mm × 150mm × 51mm	No	✓	✓	✓	195
9SG5748P5G01	—	—	—	9SG5748P5G01	φ 172mm × 150mm × 51mm	No	✓	✓	✓	195
9SG5748P5H01	—	—	—	9SG5748P5H01	φ 172mm × 150mm × 51mm	No	✓	✓	✓	195
9TG24P0G01	9TG24G002	9TG24G001	—	9TG24P0G01	φ 175mm × 69mm	—	✓	✓	✓	381
9TG24P0S01	9TG24S002	9TG24S001	—	9TG24P0S01	φ 175mm × 69mm	—	✓	✓	✓	381
9TGA24P0H001	—	—	—	9TGA24P0H001	φ 175mm × 69mm	—	✓	✓	✓	379
9TGA48P0G001	—	—	—	9TGA48P0G001	φ 175mm × 69mm	—	✓	✓	✓	379
9TG48P0G01	—	—	—	9TG48P0G01	φ 175mm × 69mm	—	✓	✓	✓	381
9TJ24P0H61	—	—	—	9TJ24P0H61	φ 133mm × 91mm	—	✓	✓	✓	375
9TJ48P0H01	—	—	—	9TJ48P0H01	φ 133mm × 91mm	—	✓	✓	✓	375
9TM24P4H01	—	—	—	9TM24P4H01	φ 100mm × 25mm	—	✓	✓	✓	373
9TM48P4H01	—	—	—	9TM48P4H01	φ 100mm × 25mm	—	✓	✓	✓	373
9TN24P1H01	—	—	—	9TN24P1H01	φ 150mm × 35mm	—	✓	✓	✓	377
9TN48P1H01	—	—	—	9TN48P1H01	φ 150mm × 35mm	—	✓	✓	✓	377
9TP24P0H001	—	—	—	9TP24P0H001	φ 221mm × 71mm	—	✓	✓	✓	383

Models listed in the main section of this catalog	List of models (models not listed in the main section of this catalog are options. Standards for optional model numbers may differ from the certified standards listed at right. Contact us for details of models with "-" model numbers.)				Frame Size	Rib	Standard (certification status is for the models listed in this catalog, and standards for optional model numbers may differ.)			page
	Without sensor	With pulse sensor	With lock sensor	With PWM control function and pulse sensor			UL (cUL)	CSA (cUL)	TÜV	
							✓	✓	✓	
9TP48P0G001	—	—	—	9TP48P0G001	φ 221mm × 71mm	—	✓	✓	✓	383
9TP48P0H001	—	—	—	9TP48P0H001	φ 221mm × 71mm	—	✓	✓	✓	383
9TS48P0G001	—	—	—	9TS48P0G001	φ 225mm × 99mm	—	✓	✓	✓	385
9TS48P0H001	—	—	—	9TS48P0H001	φ 225mm × 99mm	—	✓	✓	✓	385
9W1TG48P0H61	—	—	—	9W1TG48P0H61	φ 175mm × 69mm	—	✓	✓	✓	301
9W1TJ24P0H61	—	—	—	9W1TJ24P0H61	φ 133mm × 91mm	—	✓	✓	✓	297
9W1TJ48P0H61	—	—	—	9W1TJ48P0H61	φ 133mm × 91mm	—	✓	✓	✓	297
9W1TM48P4G01	—	—	—	9W1TM48P4G01	φ 100mm × 25mm	—	✓	✓	✓	295
9W1TM48P4H01	—	—	—	9W1TM48P4H01	φ 100mm × 25mm	—	✓	✓	✓	295
9W1TN48P1H01	—	—	—	9W1TN48P1H01	φ 150mm × 35mm	—	✓	✓	✓	299
9WB1412H501	9WB1412H502	9WB1412H501	—	—	140 × 140 × 51mm	No	✓	✓	✓	287
9WB1412M501	9WB1412M502	9WB1412M501	9WB1412M5D01	—	140 × 140 × 51mm	No	✓	✓	✓	287
9WB1412S501	9WB1412S502	9WB1412S501	9WB1412S5D01	—	140 × 140 × 51mm	No	✓	✓	✓	287
9WB1424H501	9WB1424H502	9WB1424H501	9WB1424H5D01	—	140 × 140 × 51mm	No	✓	✓	✓	287
9WB1424M501	9WB1424M502	9WB1424M501	—	—	140 × 140 × 51mm	No	✓	✓	✓	287
9WB1448H501	9WB1448H502	9WB1448H501	9WB1448H5D01	—	140 × 140 × 51mm	No	✓	✓	✓	287
9WB1448S501	9WB1448S502	9WB1448S501	9WB1448S5D01	—	140 × 140 × 51mm	No	✓	✓	✓	287
9WE1724K501	9WE1724K502	9WE1724K501	—	—	φ 172mm × 51mm	No	✓	✓	✓	292
9WE5724K501	9WE5724K502	9WE5724K501	—	—	φ 172mm × 150mm × 51mm	No	✓	✓	✓	291
9WE5748K501	9WE5748K502	9WE5748K501	9WE5748K5D01	9WE5748P5K01	φ 172mm × 150mm × 51mm	No	✓	✓	✓	291
9WF0424F601	9WF0424F602	9WF0424F601	9WF0424F6D01	—	40 × 40 × 20mm	Yes	✓	✓	✓	306
9WF0424H601	9WF0424H602	9WF0424H601	9WF0424H6D01	—	40 × 40 × 20mm	Yes	✓	✓	✓	306
9WF0424H701	9WF0424H702	9WF0424H701	9WF0424H7D01	—	40 × 40 × 15mm	Yes	✓	✓	✓	305
9WF0624H401	9WF0624H402	9WF0624H401	9WF0624H4D01	—	60 × 60 × 25mm	Yes	✓	✓	✓	309
9WF0624H601	—	9WF0624H601	9WF0624H6D01	—	60 × 60 × 20mm	Yes	✓	✓	✓	308
9WF0624H701	9WF0624H702	9WF0624H701	9WF0624H7D01	—	60 × 60 × 15mm	Yes	✓	✓	✓	307
9WF0824S401	9WF0824S402	9WF0824S401	9WF0824S4D01	—	80 × 80 × 25mm	Yes	✓	✓	✓	310
9WF0924H201	9WF0924H202	9WF0924H201	9WF0924H2D01	—	92 × 92 × 32mm	Yes	✓	✓	✓	313
9WF0924H2011	—	—	—	—	92 × 92 × 32mm	No	✓	✓	✓	313
9WF0924H401	9WF0924H402	9WF0924H401	9WF0924H4D01	—	92 × 92 × 25mm	Yes	✓	✓	✓	311
9WF0924H4011	—	—	9WF0924H4D011	—	92 × 92 × 25mm	No	✓	✓	✓	311
9WF0924S201	9WF0924S202	9WF0924S201	9WF0924S2D01	—	92 × 92 × 32mm	Yes	✓	✓	✓	313
9WF0924S2011	—	—	—	—	92 × 92 × 32mm	No	✓	✓	✓	313
9WF1224H101	9WF1224H102	9WF1224H101	9WF1224H1D01	—	120 × 120 × 38mm	Yes	✓	✓	✓	315
9WG1212E101-E	9WG1212E102-E	9WG1212E101-E	9WG1212E1D01-E	—	120 × 120 × 38mm	No	✓	✓	✓	281
9WG1212F101-E	9WG1212F102-E	9WG1212F101-E	—	—	120 × 120 × 38mm	No	✓	✓	✓	281
9WG1212G101-E	9WG1212G102-E	9WG1212G101-E	9WG1212G1D01-E	—	120 × 120 × 38mm	No	✓	✓	✓	281
9WG1212H101-E	9WG1212H102-E	9WG1212H101-E	9WG1212H1D01-E	—	120 × 120 × 38mm	No	✓	✓	✓	281
9WG1212M101-E	9WG1212M102-E	9WG1212M101-E	—	—	120 × 120 × 38mm	No	✓	✓	✓	281
9WG1224E101-E	9WG1224E102-E	9WG1224E101-E	9WG1224E1D01-E	—	120 × 120 × 38mm	No	✓	✓	✓	281
9WG1224F101-E	9WG1224F102-E	9WG1224F101-E	9WG1224F1D01-E	—	120 × 120 × 38mm	No	✓	✓	✓	281
9WG1224G101-E	9WG1224G102-E	9WG1224G101-E	9WG1224G1D01-E	—	120 × 120 × 38mm	No	✓	✓	✓	281
9WG1224H101-E	9WG1224H102-E	9WG1224H101-E	9WG1224H1D01-E	—	120 × 120 × 38mm	No	✓	✓	✓	281
9WG1224M101-E	9WG1224M102-E	9WG1224M101-E	—	—	120 × 120 × 38mm	No	✓	✓	✓	281
9WG1248E101-E	9WG1248E102-E	9WG1248E101-E	—	—	120 × 120 × 38mm	No	✓	✓	✓	281
9WG1248F101-E	9WG1248F102-E	9WG1248F101-E	—	—	120 × 120 × 38mm	No	✓	✓	✓	281
9WG1248G101-E	9WG1248G102-E	9WG1248G101-E	—	—	120 × 120 × 38mm	No	✓	✓	✓	281
9WG1248H101-E	9WG1248H102-E	9WG1248H101-E	9WG1248H1D01-E	—	120 × 120 × 38mm	No	✓	✓	✓	281
9WG1248M101-E	9WG1248M102-E	9WG1248M101-E	—	—	120 × 120 × 38mm	No	✓	✓	✓	281
9WG5748P5G001	9WG5748G5002	—	—	9WG5748P5G001	φ 172mm × 150mm × 51mm	No	✓	✓	✓	289
9WG5748P5H001	—	9WG5748H5001	9WG5748H5D001	9WG5748P5H001	φ 172mm × 150mm × 51mm	No	✓	✓	✓	289
9WL0412P3G001	—	9WL0412G3001	—	9WL0412P3G001	40 × 40 × 28mm	No	✓	✓	✓	248
9WL0412P3J001	9WL0412J3002	9WL0412J3001	—	9WL0412P3J001	40 × 40 × 28mm	No	✓	✓	✓	248
9WL0424P3G001	9WL0424G3002	9WL0424G3001	—	9WL0424P3G001	40 × 40 × 28mm	No	✓	✓	✓	248
9WL0424P3J001	9WL0424J3002	9WL0424J3001	—	9WL0424P3J001	40 × 40 × 28mm	No	✓	✓	✓	248
9WL0612P4H001	—	—	—	9WL0612P4H001	60 × 60 × 25mm	No	✓	✓	✓	251
9WL0612P4J001	9WL0612J4002	—	9WL0612J4D001	9WL0612P4J001	60 × 60 × 25mm	No	✓	✓	✓	251
9WL0612P4S001	9WL0612S4002	—	9WL0612S4D001	9WL0612P4S001	60 × 60 × 25mm	No	✓	✓	✓	251
9WL0624P4H001	—	—	—	9WL0624P4H001	60 × 60 × 25mm	No	✓	✓	✓	251
9WL0624P4J001	—	—	—	9WL0624P4J001	60 × 60 × 25mm	No	✓	✓	✓	251
9WL0624P4S001	—	—	—	9WL0624P4S001	60 × 60 × 25mm	No	✓	✓	✓	251
9WL0812P4G001	—	—	9WL0812G4D001	9WL0812P4G001	80 × 80 × 25mm	No	✓	✓	✓	257

Models listed in the main section of this catalog	List of models (models not listed in the main section of this catalog are options. Standards for optional model numbers may differ from the certified standards listed at right. Contact us for details of models with "-" model numbers.)				Frame Size	Rib	Standard (certification status is for the models listed in this catalog, and standards for optional model numbers may differ.)			page
	Without sensor	With pulse sensor	With lock sensor	With PWM control function and pulse sensor			UL	CSA	TÜV	
							(cUL)	(cUL)		
9WL0812P4H001	—	—	—	9WL0812P4H001	80×80×25mm	No	✓	✓	✓	257
9WL0812P4J001	—	—	—	9WL0812P4J001	80×80×25mm	No	✓	✓	✓	257
9WL0824P4G001	—	—	—	9WL0824P4G001	80×80×25mm	No	✓	✓	✓	257
9WL0824P4H001	—	—	—	9WL0824P4H001	80×80×25mm	No	✓	✓	✓	257
9WL0824P4J001	—	—	—	9WL0824P4J001	80×80×25mm	No	✓	✓	✓	257
9WL0912P4G001	—	—	—	9WL0912P4G001	92×92×25mm	No	✓	✓	✓	267
9WL0912P4H001	—	—	—	9WL0912P4H001	92×92×25mm	No	✓	✓	✓	267
9WL0912P4J001	9WL0912J4002	—	—	9WL0912P4J001	92×92×25mm	No	✓	✓	✓	267
9WL0912P4S001	—	—	—	9WL0912P4S001	92×92×25mm	No	✓	✓	✓	267
9WL0924P4H001	—	—	—	9WL0924P4H001	92×92×25mm	No	✓	✓	✓	267
9WL0924P4J001	—	—	—	9WL0924P4J001	92×92×25mm	No	✓	✓	✓	267
9WL0924P4S001	—	—	—	9WL0924P4S001	92×92×25mm	No	✓	✓	✓	267
9WP0412F6001	9WP0412F6002	9WP0412F6001	—	—	40×40×20mm	Yes	✓	✓	✓	247
9WP0412H6001	9WP0412H6002	9WP0412H6001	—	—	40×40×20mm	Yes	✓	✓	✓	247
9WP0612D401	9WP0612D402	9WP0612D401	9WP0612D4D01	—	60×60×25mm	Yes	✓	✓	✓	255
9WP0612D4011	—	9WP0612D4011	9WP0612D4D011	—	60×60×25mm	No	✓	✓	✓	255
9WP0612G401	9WP0612G402	9WP0612G401	9WP0612G4D01	9WP0612P4G01	60×60×25mm	Yes	✓	✓	✓	255
9WP0612G4011	9WP0612G4021	9WP0612G4011	—	—	60×60×25mm	No	✓	✓	✓	255
9WP0612H401	9WP0612H402	9WP0612H401	9WP0612H4D01	—	60×60×25mm	Yes	✓	✓	✓	255
9WP0612H4011	9WP0612H4021	9WP0612H4011	9WP0612H4D011	—	60×60×25mm	No	✓	✓	✓	255
9WP0624G401	9WP0624G402	9WP0624G401	9WP0624G4D01	—	60×60×25mm	Yes	✓	✓	✓	255
9WP0624G4011	—	9WP0624G4011	—	—	60×60×25mm	No	✓	✓	✓	255
9WP0624H401	9WP0624H402	9WP0624H401	9WP0624H4D01	—	60×60×25mm	Yes	✓	✓	✓	255
9WP0624H4011	9WP0624H4021	9WP0624H4011	9WP0624H4D011	—	60×60×25mm	No	✓	✓	✓	255
9WP0624J401	9WP0624J402	9WP0624J401	—	—	60×60×25mm	Yes	✓	✓	✓	255
9WP0624J4011	—	—	—	—	60×60×25mm	No	✓	✓	✓	255
9WP0648H401	9WP0648H402	9WP0648H401	9WP0648H4D01	—	60×60×25mm	Yes	✓	✓	✓	255
9WP0648H4011	9WP0648H4021	9WP0648H4011	9WP0648H4D011	—	60×60×25mm	No	✓	✓	✓	255
9WP0812G401	9WP0812G402	9WP0812G401	9WP0812G4D01	9WP0812P4G01	80×80×25mm	Yes	✓	✓	✓	261
9WP0812G4011	9WP0812G4021	9WP0812G4011	9WP0812G4D011	—	80×80×25mm	No	✓	✓	✓	261
9WP0812H401	9WP0812H402	9WP0812H401	9WP0812H4D01	—	80×80×25mm	Yes	✓	✓	✓	261
9WP0812H4011	9WP0812H4021	9WP0812H4011	9WP0812H4D011	—	80×80×25mm	No	✓	✓	✓	261
9WP0824H401	9WP0824H402	9WP0824H401	9WP0824H4D01	—	80×80×25mm	Yes	✓	✓	✓	261
9WP0824H4011	9WP0824H4021	9WP0824H4011	9WP0824H4D011	—	80×80×25mm	No	✓	✓	✓	261
9WP0824S401	9WP0824S402	9WP0824S401	9WP0824S4D01	—	80×80×25mm	Yes	✓	✓	✓	261
9WP0824S4011	—	9WP0824S4011	—	—	80×80×25mm	No	✓	✓	✓	261
9WP0848S401	9WP0848S402	9WP0848S401	9WP0848S4D01	—	80×80×25mm	Yes	✓	✓	✓	261
9WP0848S4011	9WP0848S4021	9WP0848S4011	9WP0848S4D011	—	80×80×25mm	No	✓	✓	✓	261
9WP0912F401	9WP0912F402	9WP0912F401	9WP0912F4D01	—	92×92×25mm	Yes	—	—	—	273
9WP0912F4011	—	—	—	—	92×92×25mm	No	—	—	—	273
9WP0912S401	—	9WP0912S401	9WP0912S4D01	—	92×92×25mm	Yes	—	—	—	273
9WP0912S4011	—	9WP0912S4011	—	—	92×92×25mm	No	—	—	—	273
9WP0924B401	9WP0924B402	9WP0924B401	9WP0924B4D01	—	92×92×25mm	Yes	✓	✓	✓	273
9WP0924B4011	9WP0924B4021	9WP0924B4011	9WP0924B4D011	—	92×92×25mm	No	✓	✓	✓	273
9WP0924F401	9WP0924F402	9WP0924F401	9WP0924F4D01	—	92×92×25mm	Yes	✓	✓	✓	273
9WP0924F4011	9WP0924F4021	9WP0924F4011	9WP0924F4D011	—	92×92×25mm	No	✓	✓	✓	273
9WP0924G401	9WP0924G402	9WP0924G401	9WP0924G4D01	—	92×92×25mm	Yes	✓	✓	✓	273
9WP0924G4011	—	9WP0924G4011	—	—	92×92×25mm	No	✓	✓	✓	273
9WP0924H401	9WP0924H402	9WP0924H401	9WP0924H4D01	—	92×92×25mm	Yes	✓	✓	✓	273
9WP0924H4011	—	—	—	—	92×92×25mm	No	✓	✓	✓	273
9WP0924S401	9WP0924S402	9WP0924S401	9WP0924S4D01	—	92×92×25mm	Yes	—	—	—	273
9WP0924S4011	—	—	—	—	92×92×25mm	No	✓	✓	✓	273
9WP1212H101	9WP1212H102	9WP1212H101	9WP1212H1D01	—	120×120×38mm	Yes	✓	✓	✓	279
9WP1212H1011	9WP1212H1021	9WP1212H1011	9WP1212H1D011	—	120×120×38mm	No	✓	✓	✓	279
9WP1212L101	—	9WP1212L101	—	—	120×120×38mm	Yes	✓	✓	✓	279
9WP1212L1011	—	—	—	—	120×120×38mm	No	✓	✓	✓	279
9WP1224H101	9WP1224H102	9WP1224H101	9WP1224H1D01	—	120×120×38mm	Yes	✓	✓	✓	279
9WP1224H1011	9WP1224H1021	9WP1224H1011	9WP1224H1D011	—	120×120×38mm	No	✓	✓	✓	279
9WP1248H101	9WP1248H102	9WP1248H101	9WP1248H1D01	—	120×120×38mm	Yes	✓	✓	✓	279
9WP1248H1011	9WP1248H1021	9WP1248H1011	9WP1248H1D011	—	120×120×38mm	No	✓	✓	✓	279
9WS0812F401	9WS0812F402	9WS0812F401	9WS0812F4D01	—	80×80×25mm	Yes	✓	✓	✓	263
9WS0812F4011	9WS0812F4021	9WS0812F4011	—	—	80×80×25mm	No	✓	✓	✓	263

Please contact your point of sale regarding low-speed sensors.

Models listed in the main section of this catalog	List of models (models not listed in the main section of this catalog are options. Standards for optional model numbers may differ from the certified standards listed at right. Contact us for details of models with "-" model numbers.)				Frame Size	Rib	Standard (certification status is for the models listed in this catalog, and standards for optional model numbers may differ.)			page
	Without sensor	With pulse sensor	With lock sensor	With PWM control function and pulse sensor			UL (cUL)	CSA (cUL)	TÜV	
							✓	✓	✓	
9WS0812H401	9WS0812H402	9WS0812H401	—	—	80×80×25mm	Yes	✓	✓	✓	263
9WS0812H4011	9WS0812H4021	9WS0812H4011	—	—	80×80×25mm	No	✓	✓	✓	263
9WS0812M401	9WS0812M402	9WS0812M401	9WS0812M4D01	—	80×80×25mm	Yes	✓	✓	✓	263
9WS0812M4011	9WS0812M4021	9WS0812M4011	—	—	80×80×25mm	No	✓	✓	✓	263
9WS0824F401	9WS0824F402	9WS0824F401	—	—	80×80×25mm	Yes	✓	✓	✓	263
9WS0824F4011	9WS0824F4021	9WS0824F4011	—	—	80×80×25mm	No	✓	✓	✓	263
9WS0824H401	9WS0824H402	9WS0824H401	9WS0824H4D01	—	80×80×25mm	Yes	✓	✓	✓	263
9WS0824H4011	9WS0824H4021	9WS0824H4011	—	—	80×80×25mm	No	✓	✓	✓	263
9WS0824M401	9WS0824M402	9WS0824M401	9WS0824M4D01	—	80×80×25mm	Yes	✓	✓	✓	263
9WS0824M4011	9WS0824M4021	9WS0824M4011	—	—	80×80×25mm	No	✓	✓	✓	263
9WS0912F401	9WS0912F402	9WS0912F401	9WS0912F4D01	—	92×92×25mm	Yes	✓	✓	✓	271
9WS0912H401	9WS0912H402	9WS0912H401	—	—	92×92×25mm	Yes	✓	✓	✓	271
9WS0912L401	9WS0912L402	9WS0912L401	—	—	92×92×25mm	Yes	✓	✓	✓	271
9WS0912M401	9WS0912M402	9WS0912M401	—	—	92×92×25mm	Yes	✓	✓	✓	271
9WS0924F401	9WS0924F402	9WS0924F401	—	—	92×92×25mm	Yes	✓	✓	✓	271
9WS0924H401	9WS0924H402	9WS0924H401	9WS0924H4D01	—	92×92×25mm	Yes	✓	✓	✓	271
9WS0924L401	9WS0924L402	9WS0924L401	—	—	92×92×25mm	Yes	✓	✓	✓	271
9WS0924M401	9WS0924M402	9WS0924M401	9WS0924M4D01	—	92×92×25mm	Yes	✓	✓	✓	271
9WS1212H101	9WS1212H102	9WS1212H101	—	—	120×120×38mm	Yes	✓	✓	✓	283
9WS1212H1011	9WS1212H1021	9WS1212H1011	—	—	120×120×38mm	No	✓	✓	✓	283
9WS1212M101	9WS1212M102	9WS1212M101	—	—	120×120×38mm	Yes	✓	✓	✓	283
9WS1212M1011	9WS1212M1021	9WS1212M1011	—	—	120×120×38mm	No	✓	✓	✓	283
9WS1224H101	9WS1224H102	9WS1224H101	—	—	120×120×38mm	Yes	✓	✓	✓	283
9WS1224H1011	9WS1224H1021	9WS1224H1011	—	—	120×120×38mm	No	✓	✓	✓	283
9WS1224M101	9WS1224M102	9WS1224M101	—	—	120×120×38mm	Yes	✓	✓	✓	283
9WS1224M1011	9WS1224M1021	9WS1224M1011	—	—	120×120×38mm	No	✓	✓	✓	283
9WS1248H101	9WS1248H102	9WS1248H101	9WS1248H1D01	—	120×120×38mm	Yes	✓	✓	✓	283
9WS1248H1011	9WS1248H1021	9WS1248H1011	9WS1248H1D011	—	120×120×38mm	No	✓	✓	✓	283
9WS1248M101	9WS1248M102	9WS1248M101	9WS1248M1D01	—	120×120×38mm	Yes	✓	✓	✓	283
9WS1248M1011	9WS1248M1021	9WS1248M1011	9WS1248M1D011	—	120×120×38mm	No	✓	✓	✓	283
9WV0812P1M001	—	9WV0812M1001	9WV0812M1D001	9WV0812P1M001	80×80×38mm	Yes	✓	✓	✓	265
9WV0848P1H001	—	—	—	9WV0848P1H001	80×80×38mm	Yes	✓	✓	✓	265
9WV0848P1H0011	—	—	—	9WV0848P1H0011	80×80×38mm	No	✓	✓	✓	265
9WV0924P1H001	—	—	—	9WV0924P1H001	92×92×38mm	Yes	✓	✓	✓	275
9WV0948P1H001	—	—	—	9WV0948P1H001	92×92×38mm	Yes	✓	✓	✓	275
9WV1212P1J001	9WV1212J1002	—	—	9WV1212P1J001	120×120×38mm	No	✓	✓	✓	277
9WV1224P1H001	9WV1224H102	9WV1224H101	9WV1224H1D001	9WV1224P1H001	120×120×38mm	No	✓	✓	✓	277
9WV1224P1J601	—	9WV1224J1001	—	9WV1224P1J601	120×120×38mm	No	✓	✓	✓	277
9WV1248P1J001	9WV1248J1002	9WV1248J1001	9WV1248J1D001	9WV1248P1J001	120×120×38mm	No	✓	✓	✓	277

Please contact your point of sale regarding low-speed sensors.