

- Advanced Process Technology
- Ultra Low On-Resistance
- Dual N-Channel MOSFET
- Surface Mount
- Available in Tape & Reel
- Dynamic dv/dt Rating
- Fast Switching

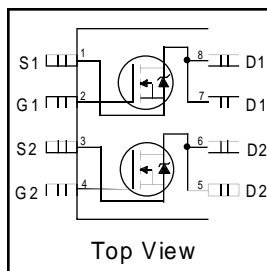

| |
|----------------------------|
| $V_{DSS} = 50V$ |
| $R_{DS(on)} = 0.130\Omega$ |
| $I_D = 3.0A$ |

Description

Fourth Generation HEXFETs from International Rectifier utilize advanced processing techniques to achieve the lowest possible on-resistance per silicon area. This benefit, combined with the fast switching speed and ruggedized device design that HEXFET Power MOSFETs are well known for, provides the designer with an extremely efficient device for use in a wide variety of applications.

The SO-8 has been modified through a customized leadframe for enhanced thermal characteristics and dual-die capability making it ideal in a variety of power applications. With these improvements, multiple devices can be used in an application with dramatically reduced board space. The package is designed for vapor phase, infra red, or wave soldering techniques. Power dissipation of greater than 0.8W is possible in a typical PCB mount application.

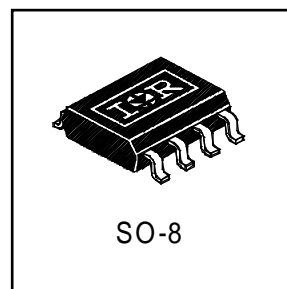

Absolute Maximum Ratings

| | Parameter | Max. | Units |
|--------------------------|------------------------------------------|--------------|-------|
| $I_D @ T_A = 25^\circ C$ | Continuous Drain Current, $V_{GS} @ 10V$ | 3.0 | A |
| $I_D @ T_A = 70^\circ C$ | Continuous Drain Current, $V_{GS} @ 10V$ | 2.3 | |
| I_{DM} | Pulsed Drain Current ① | 10 | |
| $P_D @ T_C = 25^\circ C$ | Power Dissipation | 2.0 | W |
| | Linear Derating Factor | 0.016 | W/°C |
| V_{GS} | Gate-to-Source Voltage | ± 20 | V |
| dv/dt | Peak Diode Recovery dv/dt ② | 4.5 | V/nS |
| T_J, T_{STG} | Junction and Storage Temperature Range | -55 to + 150 | °C |

Thermal Resistance Ratings

| | Parameter | Min. | Typ. | Max. | Units |
|-----------------|-------------------------------|------|------|------|-------|
| $R_{\theta JA}$ | Maximum Junction-to-Ambient ④ | — | — | 62.5 | °C/W |

Electrical Characteristics @ $T_J = 25^\circ\text{C}$ (unless otherwise specified)

| | Parameter | Min. | Typ. | Max. | Units | Conditions |
|---------------------------------|--------------------------------------|------|-------|------|----------|-------------------------------------------------------------------|
| $V_{(BR)DSS}$ | Drain-to-Source Breakdown Voltage | 50 | — | — | V | $V_{GS} = 0V, I_D = 250\mu A$ |
| $\Delta V_{(BR)DSS}/\Delta T_J$ | Breakdown Voltage Temp. Coefficient | — | 0.049 | — | V/°C | Reference to $25^\circ\text{C}, I_D = 1\text{mA}$ |
| $R_{DS(ON)}$ | Static Drain-to-Source On-Resistance | — | 0.11 | 0.13 | Ω | $V_{GS} = 10V, I_D = 3.0A$ ③ |
| | | — | 0.16 | 0.20 | | $V_{GS} = 4.5V, I_D = 1.5A$ ③ |
| $V_{GS(th)}$ | Gate Threshold Voltage | 1.0 | — | 3.0 | V | $V_{DS} = V_{GS}, I_D = 250\mu A$ |
| g_{fs} | Forward Transconductance | — | 3.8 | — | S | $V_{DS} = 15V, I_D = 3.0A$ ③ |
| I_{DSS} | Drain-to-Source Leakage Current | — | — | 2.0 | μA | $V_{DS} = 40V, V_{GS} = 0V$ |
| | | — | — | 25 | | $V_{DS} = 40V, V_{GS} = 0V, T_J = 55^\circ\text{C}$ |
| I_{GSS} | Gate-to-Source Forward Leakage | — | — | 100 | nA | $V_{GS} = 20V$ |
| | Gate-to-Source Reverse Leakage | — | — | -100 | | $V_{GS} = -20V$ |
| Q_g | Total Gate Charge | — | 12 | 30 | nC | $I_D = 2.0A$ |
| Q_{gs} | Gate-to-Source Charge | — | 1.2 | — | | $V_{DS} = 25V$ |
| Q_{gd} | Gate-to-Drain ("Miller") Charge | — | 3.5 | — | | $V_{GS} = 10V$ ③ |
| $t_{d(on)}$ | Turn-On Delay Time | — | 9.0 | 20 | ns | $V_{DD} = 25V$ |
| t_r | Rise Time | — | 8.0 | 20 | | $I_D = 1.0A$ |
| $t_{d(off)}$ | Turn-Off Delay Time | — | 45 | 70 | | $R_G = 6.0\Omega$ |
| t_f | Fall Time | — | 25 | 50 | | $R_D = 25\Omega$ ③ |
| L_D | Internal Drain Inductance | — | 4.0 | — | nH | Between lead, 6mm(0.25in.) from package and center of die contact |
| L_S | Internal Source Inductance | — | 6.0 | — | | |
| C_{iss} | Input Capacitance | — | 290 | — | pF | $V_{GS} = 0V$ |
| C_{oss} | Output Capacitance | — | 140 | — | | $V_{DS} = 25V$ |
| C_{rss} | Reverse Transfer Capacitance | — | 37 | — | | $f = 1.0\text{MHz}$ |

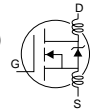

Source-Drain Ratings and Characteristics

| | Parameter | Min. | Typ. | Max. | Units | Conditions |
|----------|----------------------------------------|-----------------------------------------------------------------------------|------|------|-------|----------------------------------------------------------------|
| I_S | Continuous Source Current (Body Diode) | — | — | 2.0 | A | MOSFET symbol showing the integral reverse p-n junction diode. |
| I_{SM} | Pulsed Source Current (Body Diode) ① | — | — | 12 | | |
| V_{SD} | Diode Forward Voltage | — | — | 1.2 | V | $T_J = 25^\circ\text{C}, I_S = 1.5A, V_{GS} = 0V$ ③ |
| t_{rr} | Reverse Recovery Time | — | 70 | 100 | ns | $T_J = 25^\circ\text{C}, I_F = 1.5A$ |
| Q_{rr} | Reverse Recovery Charge | — | 110 | 170 | nC | $di/dt = 100A/\mu s$ ③ |
| t_{on} | Forward Turn-On Time | Intrinsic turn-on time is negligible (turn-on is dominated by $L_S + L_D$) | | | | |

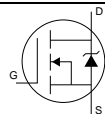

Notes:

① Repetitive rating; pulse width limited by max. junction temperature.

③ Pulse width $\leq 300\mu s$; duty cycle $\leq 2\%$.

② $I_{SD} \leq 1.8A, di/dt \leq 90A/\mu s, V_{DD} \leq V_{(BR)DSS}, T_J \leq 150^\circ\text{C}$

④ Surface mounted on FR-4 board, $t \leq 10\text{sec}$.

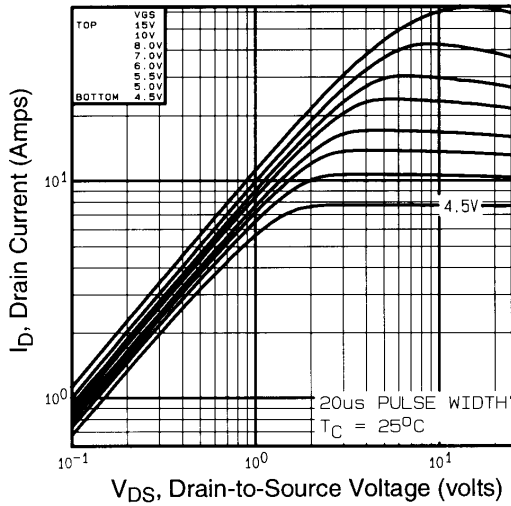

Fig 1. Typical Output Characteristics,

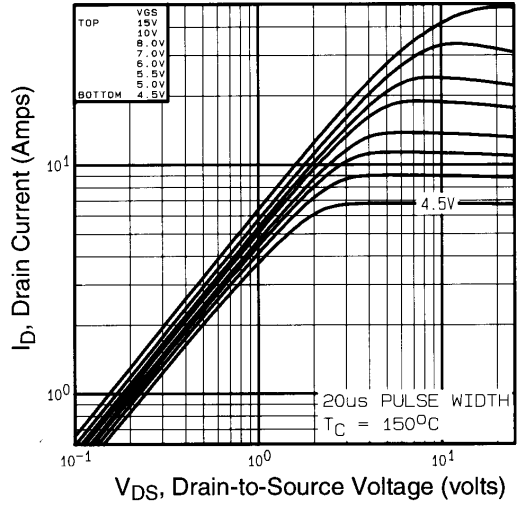

Fig 2. Typical Output Characteristics,

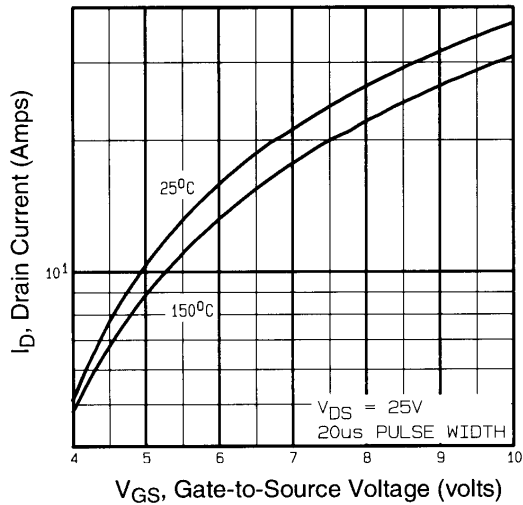

Fig 3. Typical Transfer Characteristics

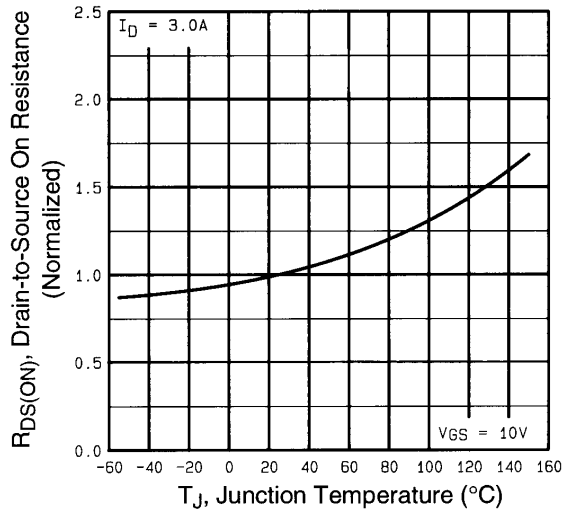

Fig 4. Normalized On-Resistance Vs. Temperature

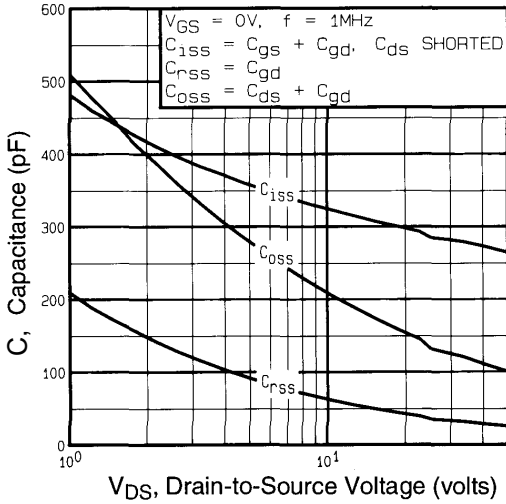

Fig 5. Typical Capacitance Vs. Drain-to-Source Voltage

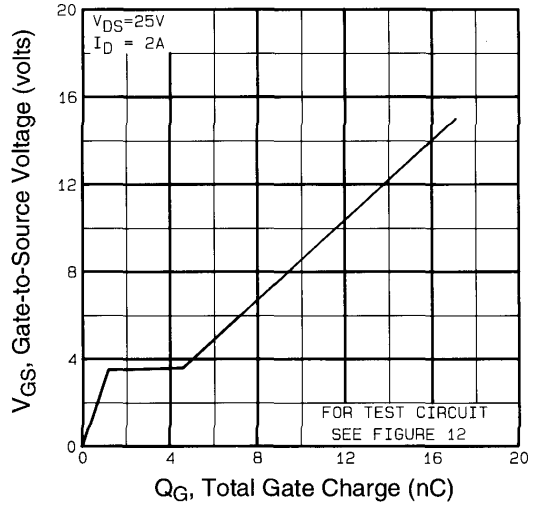

Fig 6. Typical Gate Charge Vs. Gate-to-Source Voltage

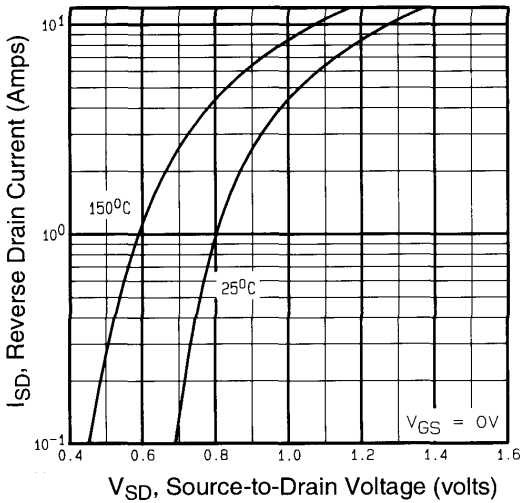

Fig 7. Typical Source-Drain Diode Forward Voltage

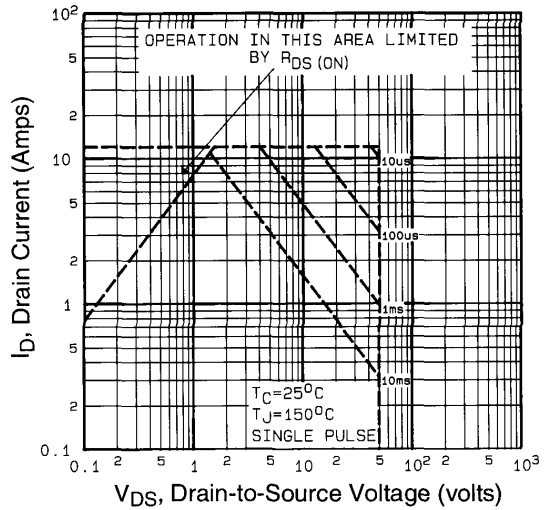

Fig 8. Maximum Safe Operating Area

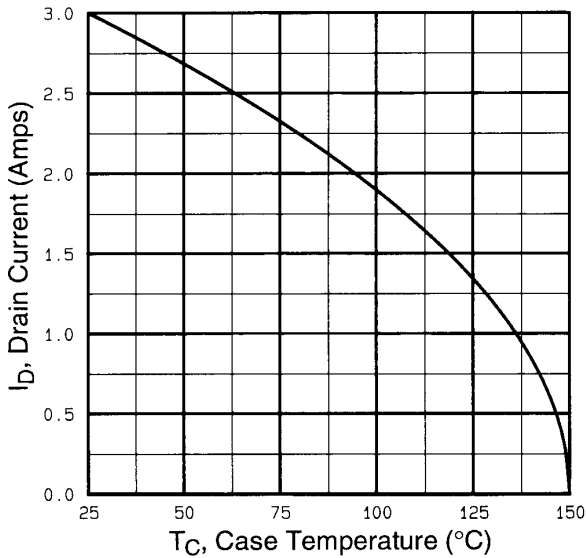

Fig 9. Maximum Drain Current Vs. Case Temperature

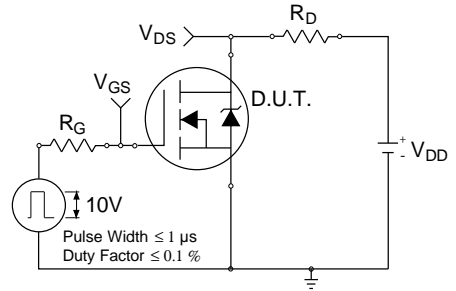

Fig 10a. Switching Time Test Circuit

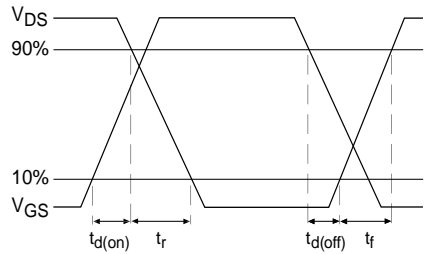

Fig 10b. Switching Time Waveforms

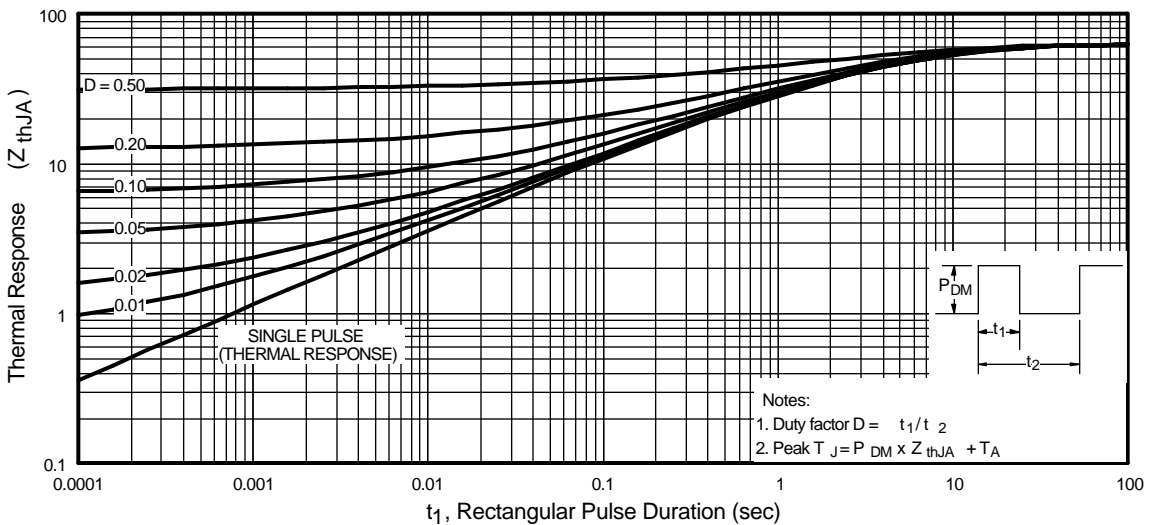

Fig 11. Maximum Effective Transient Thermal Impedance, Junction-to-Ambient

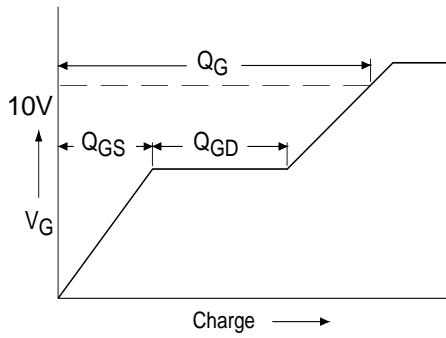

Fig 12a. Basic Gate Charge Waveform

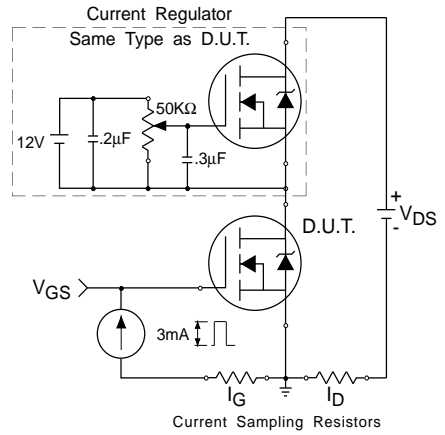
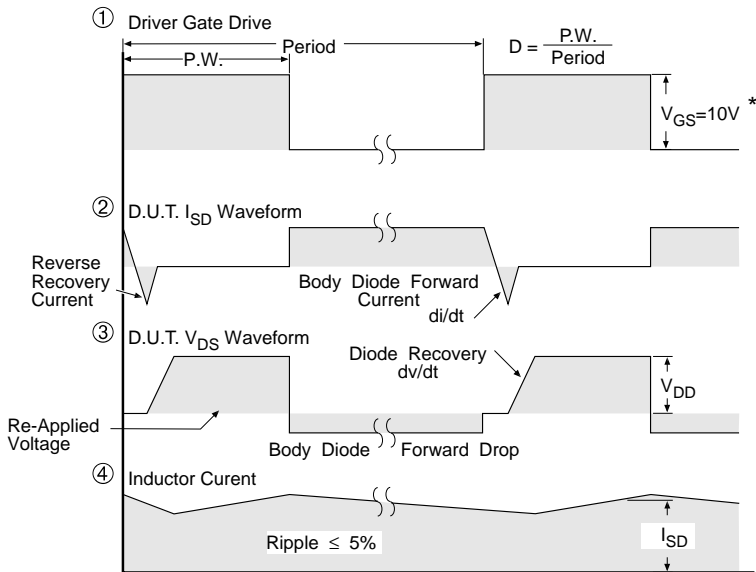
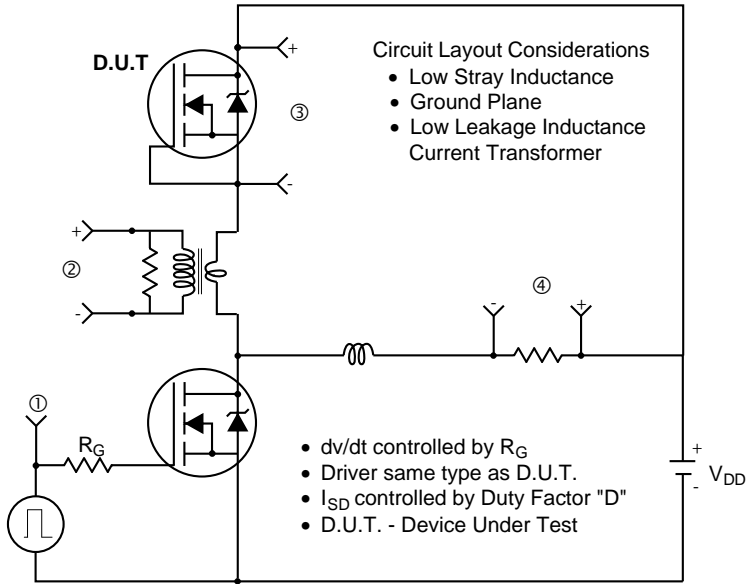

Fig 12b. Gate Charge Test Circuit

Peak Diode Recovery dv/dt Test Circuit



* $V_{GS} = 5V$ for Logic Level Devices

Fig 13. For N-Channel HEXFETS

IRF7103

Package Outline

S08 Outline

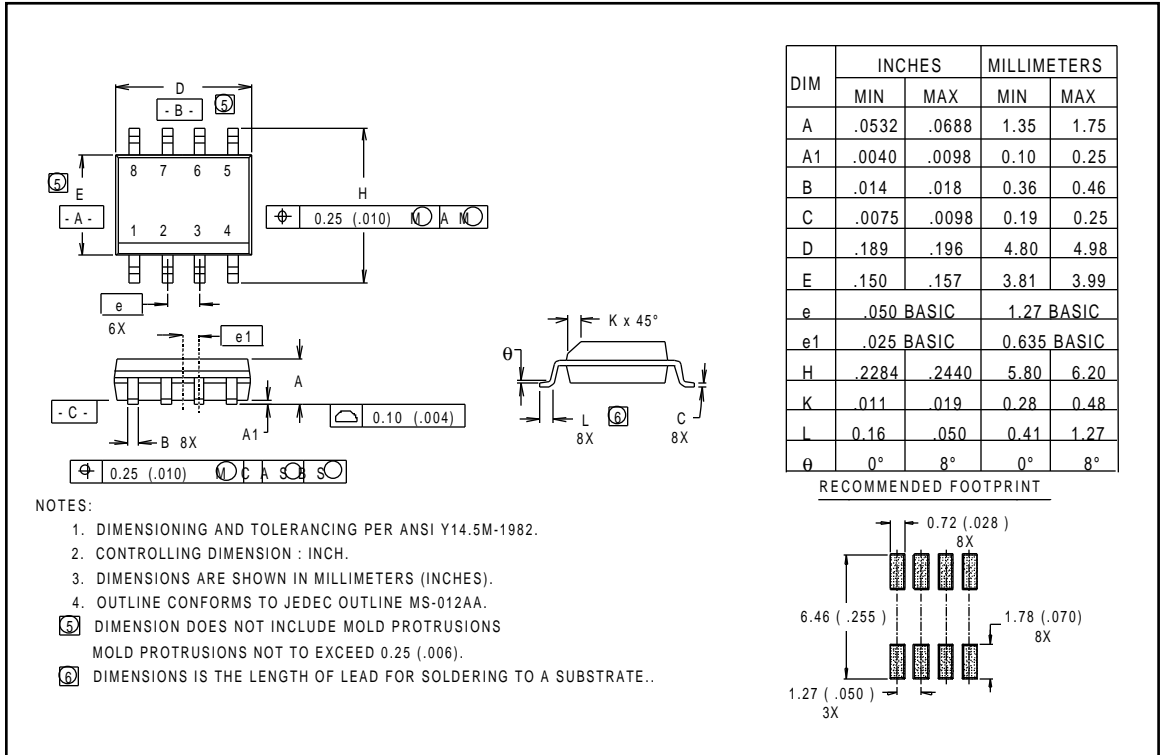

NOTES:

1. DIMENSIONING AND TOLERANCING PER ANSI Y14.5M-1982.
2. CONTROLLING DIMENSION : INCH.
3. DIMENSIONS ARE SHOWN IN MILLIMETERS (INCHES).
4. OUTLINE CONFORMS TO JEDEC OUTLINE MS-012AA.
- ⑤ DIMENSION DOES NOT INCLUDE MOLD PROTRUSIONS
MOLD PROTRUSIONS NOT TO EXCEED 0.25 (.006).
- ⑥ DIMENSIONS IS THE LENGTH OF LEAD FOR SOLDERING TO A SUBSTRATE..

Part Marking Information

S08

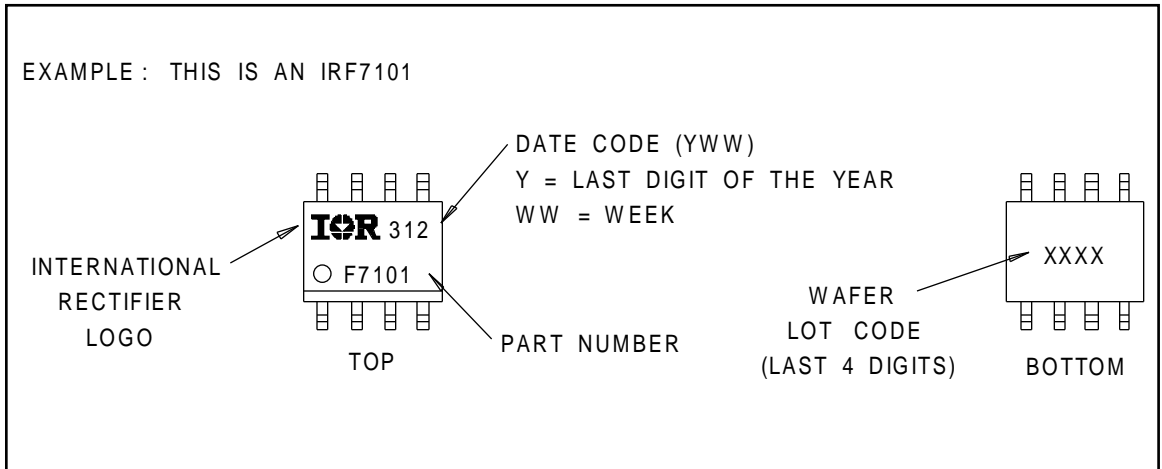

Tape & Reel Information

S08

Dimensions are shown in millimeters (inches)

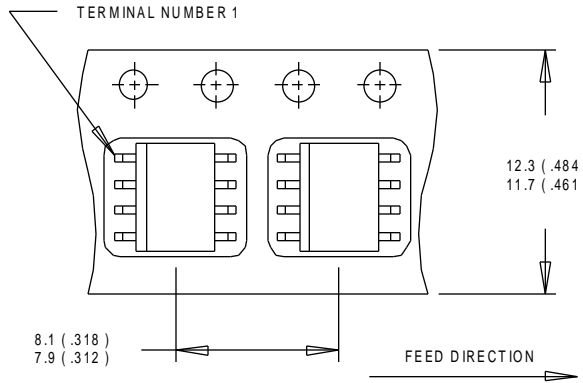

NOTES:

1. CONTROLLING DIMENSION : MILLIMETER.
2. ALL DIMENSIONS ARE SHOWN IN MILLIMETERS(INCHES).
3. OUTLINE CONFORMS TO EIA-481 & EIA-541.

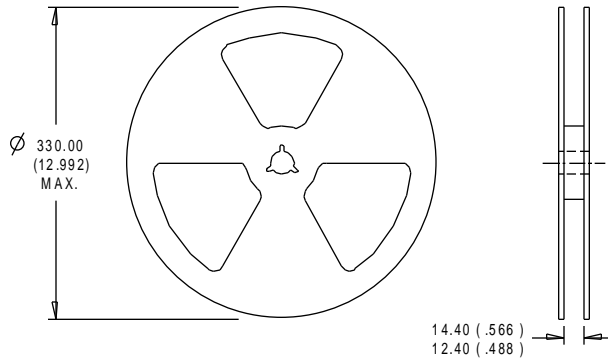

NOTES :

1. CONTROLLING DIMENSION : MILLIMETER.
2. OUTLINE CONFORMS TO EIA-481 & EIA-541.

This datasheet has been download from:

www.datasheetcatalog.com

Datasheets for electronics components.