

FEATURES

- Dual output: $f_0 = 8.45 \text{ GHz to } 9.3 \text{ GHz}$
- $f_0/2 = 4.225 \text{ GHz to } 4.65 \text{ GHz}$
- P_{out} : 12 dBm
- Phase noise: $-116 \text{ dBc/Hz at } 100 \text{ kHz}$
- No external resonator needed
- RoHS compliant, 5 mm × 5 mm SMT package: 25 mm²

APPLICATIONS

- Point to point and multipoint radio
- Test equipment and industrial controls
- VSAT

GENERAL DESCRIPTION

The HMC1160 is a MMIC voltage controlled oscillator that integrates a resonator, a negative resistance device, and a varactor diode, and features a half frequency output.

Because of the monolithic construction of the oscillator, output power and phase noise performance are excellent over temperature.

FUNCTIONAL BLOCK DIAGRAM

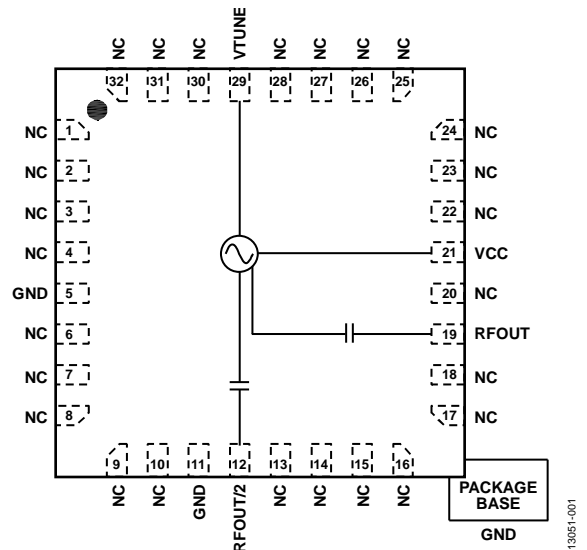

Figure 1.

Power output is 12 dBm typical from a 5 V supply voltage. The voltage controlled oscillator is housed in a RoHS compliant SMT package and requires no external matching components.

TABLE OF CONTENTS

Features	1	Interface Schematics	6
Applications.....	1	Typical Performance Characteristics	7
Functional Block Diagram	1	Evaluation Printed Circuit Board (PCB).....	9
General Description	1	Bill of Materials.....	9
Revision History	2	Packaging and Ordering Information	10
Specifications.....	3	Outline Dimensions.....	10
Absolute Maximum Ratings	4	Ordering Guide	10
ESD Caution.....	4		
Pin Configuration and Function Descriptions.....	5		

REVISION HISTORY

5/15—v00.0814 to Rev. A

This Hittite Microwave Products data sheet has been reformatted to meet the styles and standards of Analog Devices, Inc.

Updated Format.....	Universal
Added Interface Schematics Section, Renumbered Figures	
Sequentially	6
Reordered Figure Sequence, Typical Performance	
Characteristics Section.....	7
Deleted Figure: Frequency vs. Tuning Voltage, T = 25°C,	
Renumbered Figures Sequentially.....	7
Deleted Typical Applications Circuit	9
Changes to Ordering Guide	11

SPECIFICATIONS

T_A = -40°C to +85°C, V_{CC} = 5 V, unless otherwise noted.

Table 1.

Parameter	Min	Typ	Max	Unit	Test Conditions/Comments
FREQUENCY					
Range					
f ₀	8.45		9.3	GHz	
f ₀ /2	4.225		4.65	GHz	
Drift Rate		0.74		MHz/°C	
Pulling		4.5		MHz p-p	Pulling into a 2.0:1 VSWR
Pushing		5.5		MHz/V	At VTUNE = 5 V
POWER OUTPUT					
RFOUT	9		17	dBm	
RFOUT/2	0		8	dBm	
Supply Current (I _{CC})		240		mA	V _{CC} = 4.75 V
	195	260	325	mA	V _{CC} = 5.00 V
		275		mA	V _{CC} = 5.25 V
HARMONICS, SUBHARMONICS					
1/2		37		dBc	
Second		18		dBc	
Third		30		dBc	
TUNING					
Voltage (VTUNE)	2		13	V	
Sensitivity	40		250	MHz/V	
Tune Port Leakage Current			10	μA	VTUNE = 13 V
OUTPUT RETURN LOSS					
		2		dB	
SSB PHASE NOISE					
10 kHz Offset		-90	-85	dBc/Hz	
100 kHz Offset		-116	-110	dBc/Hz	

ABSOLUTE MAXIMUM RATINGS

Table 2.

Parameter	Rating
V _{CC}	5.5 V dc
VTUNE	0 V to 15 V
Temperature	
Operating	−40°C to +85°C
Storage	−65°C to +150°C
Nominal Junction (To Maintain 1 million hours MTTF)	135°C
Nominal Junction (T = 85°C)	125°C
Maximum Reflow Temperature (MSL3 Rating)	260°C
Thermal Resistance (Junction to Ground Paddle)	31°C/W
ESD Sensitivity (Human Body Model)	Class 1A

Stresses at or above those listed under Absolute Maximum Ratings may cause permanent damage to the product. This is a stress rating only; functional operation of the product at these or any other conditions above those indicated in the operational section of this specification is not implied. Operation beyond the maximum operating conditions for extended periods may affect product reliability.

ESD CAUTION**ESD (electrostatic discharge) sensitive device.**

Charged devices and circuit boards can discharge without detection. Although this product features patented or proprietary protection circuitry, damage may occur on devices subjected to high energy ESD. Therefore, proper ESD precautions should be taken to avoid performance degradation or loss of functionality.

PIN CONFIGURATION AND FUNCTION DESCRIPTIONS

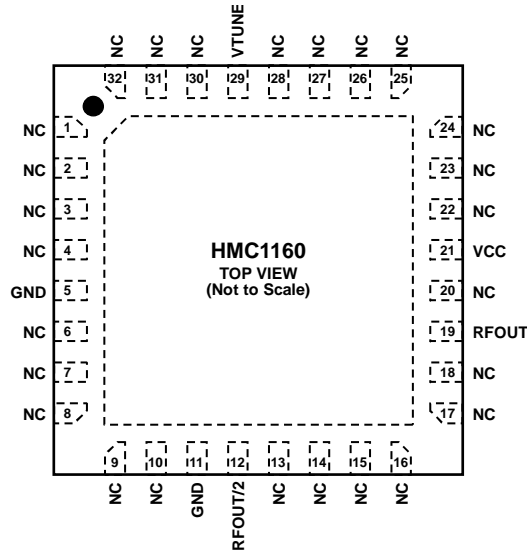

- NOTES**
1. NC = NO CONNECT. HOWEVER, THESE PINS MAY BE CONNECTED TO RF/DC GROUND WITHOUT AFFECTING THE PERFORMANCE OF THE DEVICE.
 2. THE EXPOSED PAD MUST BE CONNECTED TO RF/DC GROUND.

130851-002

Figure 2. Pin Configuration

Table 3. Pin Function Descriptions

Pin No.	Mnemonic	Description
1 to 4, 6 to 10, 13 to 18, 20, 22 to 28, 30 to 32	NC	No Connect. However, these pins can be connected to RF/dc ground without affecting the performance of the device.
12	RFOUT/2	Half Frequency Output. This pin is ac-coupled.
19	RFOUT	RF Output. This pin is ac-coupled.
21	V _{CC}	Supply Voltage (5 V).
29	VTUNE	Control Voltage and Modulation Input. The modulation bandwidth is dependent on the drive source impedance.
5, 11	GND	Ground. These pins must be connected to RF/dc ground.
	EP	Exposed Paddle. The package bottom has an exposed metal paddle that must be connected to RF/dc ground.

INTERFACE SCHEMATICS

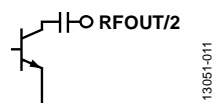

Figure 3. RFOUT/2 Interface

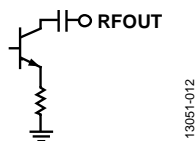

Figure 4. RFOUT Interface

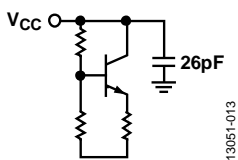

Figure 5. Vcc Interface

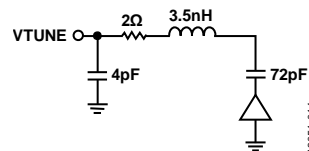

Figure 6. VTUNE Interface



Figure 7. GND Interface

TYPICAL PERFORMANCE CHARACTERISTICS

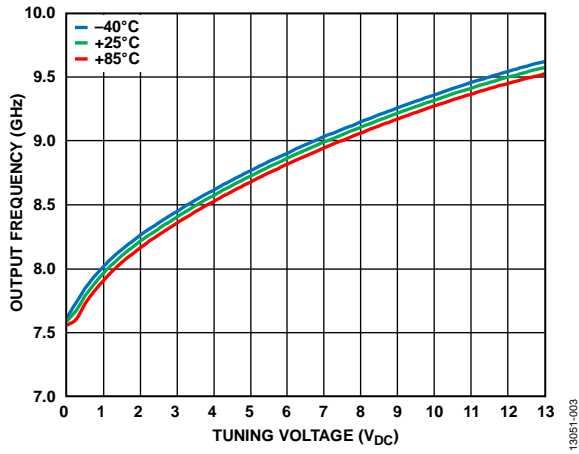

Figure 8. Frequency vs. Tuning Voltage

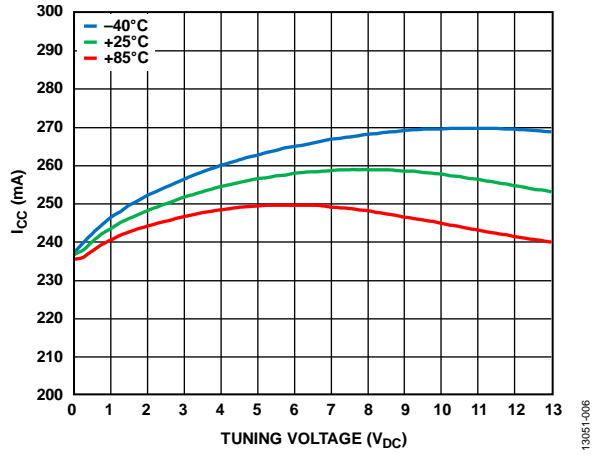

Figure 11. Supply Current (I_{cc}) vs. Tuning Voltage

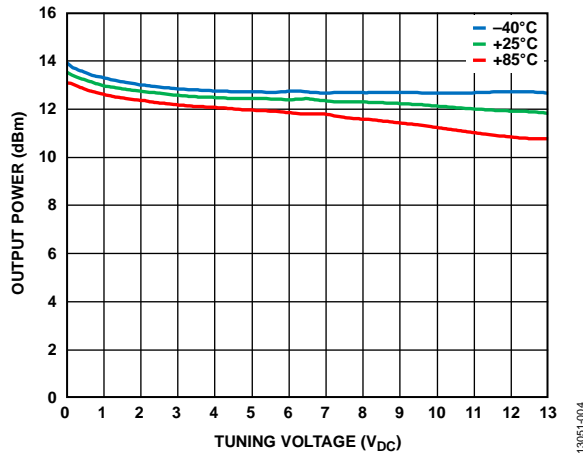

Figure 9. Output Power vs. Tuning Voltage

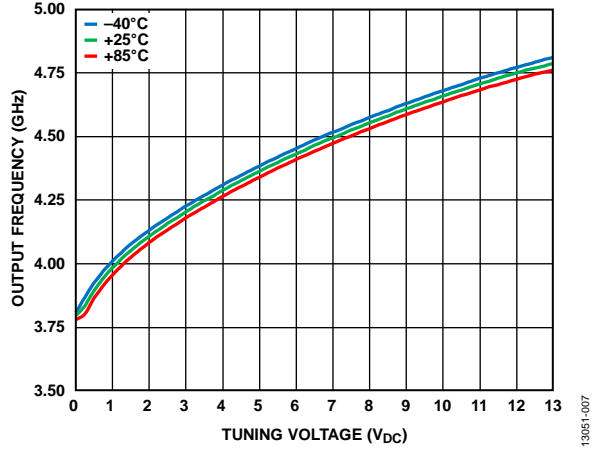

Figure 12. RFOUT/2 Output Frequency vs. Tuning Voltage

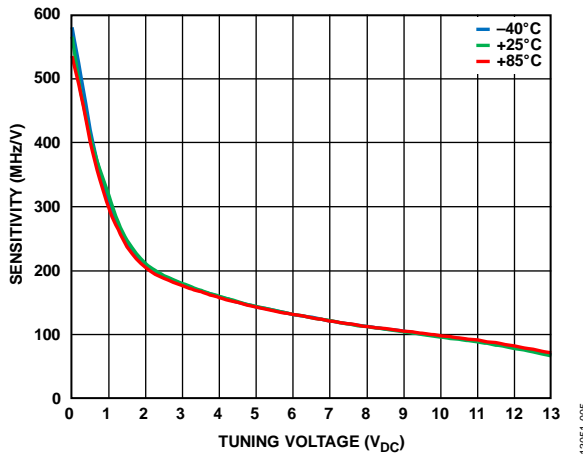

Figure 10. Sensitivity vs. Tuning Voltage

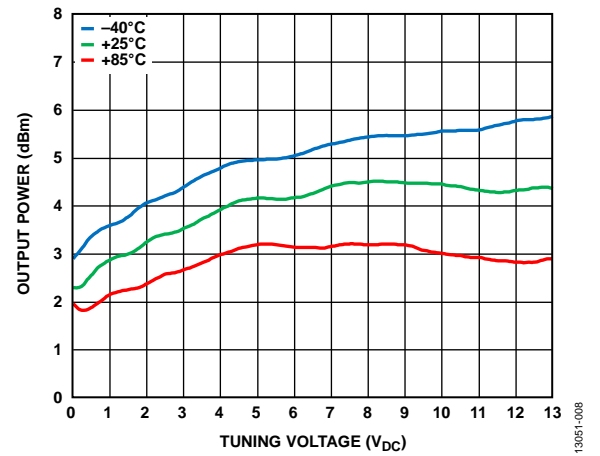

Figure 13. RFOUT/2 Output Power vs. Tuning Voltage

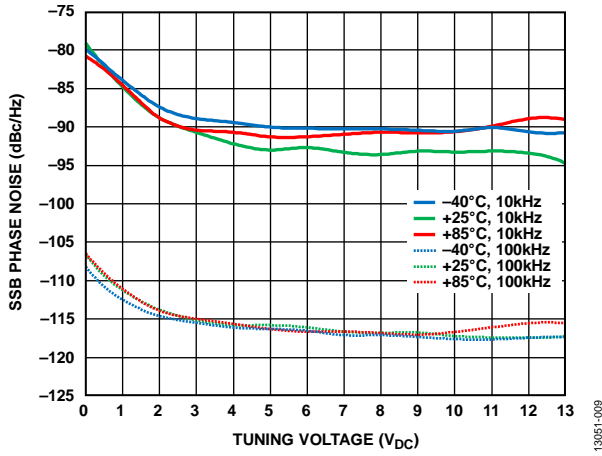

Figure 14. SSB Phase Noise vs. Tuning Voltage

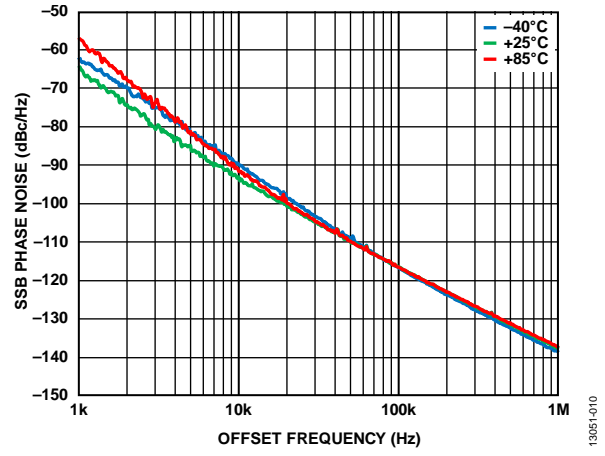

Figure 15. SSB Phase Noise at VTUNE = 5 V

EVALUATION PRINTED CIRCUIT BOARD (PCB)

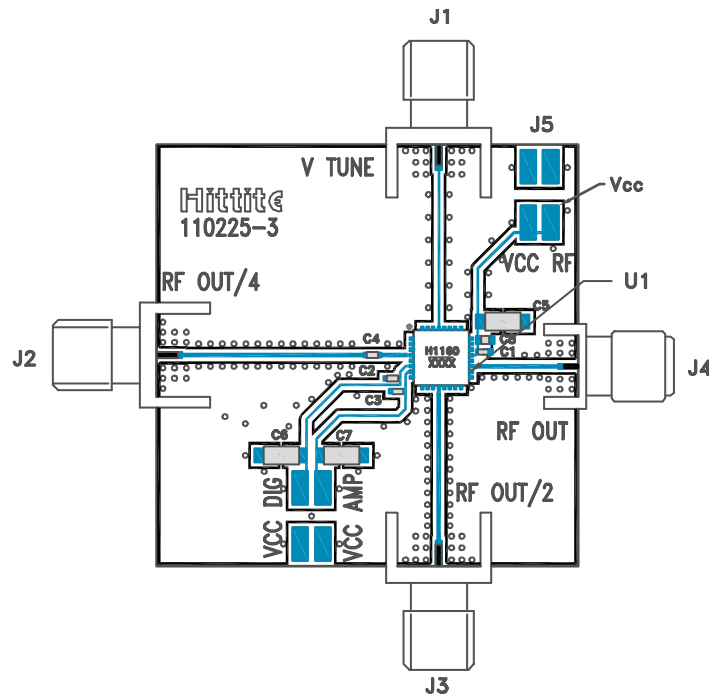

Figure 16. Evaluation Board

The circuit board used in an application uses RF circuit design techniques. Ensure that signal lines have $50\ \Omega$ impedance and that the package ground leads and backside ground paddle are connected directly to the ground plane.

Use a sufficient number of via holes to connect the top and bottom ground planes. The evaluation circuit board shown in 16 is available from Analog Devices, Inc., upon request.

BILL OF MATERIALS

Table 4. Bill of Materials EV1HMC1160LP5

Item	Description
J1 to J4	PCB mount SMA RF connector
J5, J6	2 mm dc header
C1 to C3	100 pF capacitor, 0402 package
C4	1000 pF capacitor, 0402 package
C5 to C7	2.2 μ F tantalum capacitor
C8	0.01 μ F capacitor, 0603 package
U1	HMC1160 VCO
PCB ¹	110225 evaluation board ²

¹ Circuit board material is Rogers 4350.

² Reference this number when ordering the complete evaluation PCB.

PACKAGING AND ORDERING INFORMATION

OUTLINE DIMENSIONS

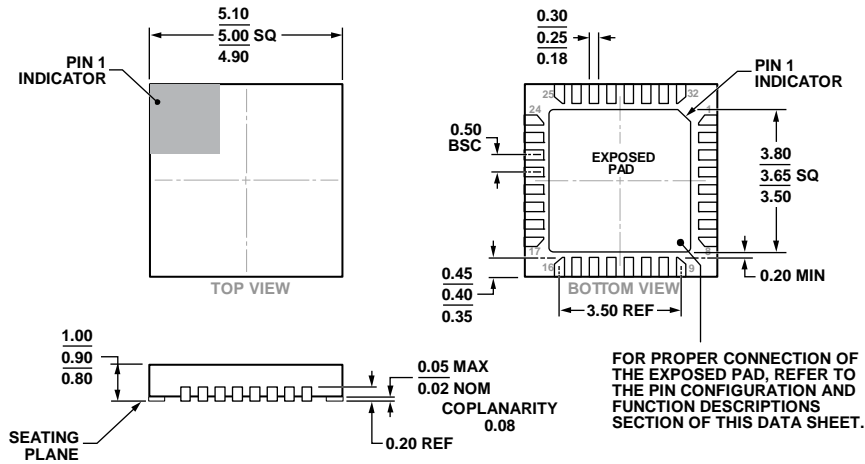

COMPLIANT TO JEDEC STANDARDS MO-220-VHHD-4.

Figure 17. 32-Lead Lead Frame Chip Scale Package [LFCSP_VQ]
 5 mm × 5 mm Body, Very Thin Quad
 (HCP-32-1)
 Dimensions shown in millimeters

ORDERING GUIDE

Model ¹	Temperature Range	MSL Rating ²	Package Description	Package Option	Qty.	Brand ³
HMC1160LP5E	-40°C to +85°C	MSL3	32-Lead LFCSP_VQ	HCP-32-1		H1160 XXXX
HMC1160LP5ETR	-40°C to +85°C	MSL3	32-Lead LFCSP_VQ, 7" Tape and Reel	HCP-32-1	500	H1160 XXXX
EV1HMC1160LP5			Evaluation Board			

¹ The HMC1160LP5E and HMC1160LP5ETR are RoHS compliant parts.

² See the Absolute Maximum Ratings section, Table 2.

³ XXXX is a placeholder for the 4-digit lot number.

Mouser Electronics

Authorized Distributor

Click to View Pricing, Inventory, Delivery & Lifecycle Information:

[Analog Devices Inc.:](#)

[HMC1160LP5E](#) [EV1HMC1160LP5](#) [HMC1160LP5ETR](#)