

Guide units FEN/FENG for ISO cylinders



Guide units FEN/FENG for ISO cylinders

Key features



At a glance

The guide units FEN and FENG protect ISO cylinders against torsion when these are subjected to high torque loads.

They offer high precision guidance for workpiece handling and other handling applications.

Two guide variants are available:

- Plain-bearing guide (GF)
- Recirculating ball bearing guide (KF)

Drive/guide unit combination options

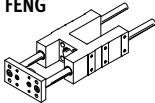
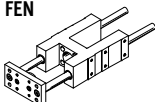
Drive/guide unit	DSBC	DSBG	DNC	DSNU
	■	■	■	-
	-	-	-	■
→ Page/Internet	dsbc	dsbg	dnc	dsnu

Position sensing

With ISO cylinder DNC:
When installed, a mounting kit is required to sense the front end position. The rear end position can be sensed directly via the sensor slot.

With ISO cylinder DSNU:
With these ISO cylinders, a mounting kit is absolutely necessary for sensing the end positions.

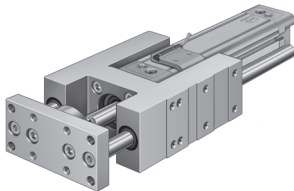

Mounting kits

Drive	Piston diameter	Part No.	Type
DSNU-...-A	8	175091	SMBR-8-8
	10	175092	SMBR-8-10
	12	175093	SMBR-8-12
	16	175094	SMBR-8-16
	20	175095	SMBR-8-20
	25	175096	SMBR-8-25
DNC-...-A	32, 40	175705	SMB-8-FENG-32/40
	50, 63	175706	SMB-8-FENG-50/63
	80, 100	175707	SMB-8-FENG-80/100

Guide units FEN/FENG for ISO cylinders

Type codes

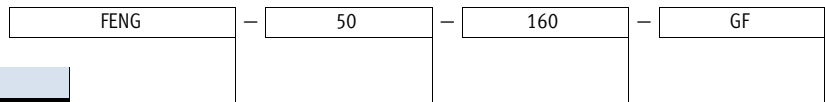

Type

FEN	Guide unit to ISO 6432
FENG	Guide unit to ISO 15552

Piston diameter [mm]

Stroke [mm]

Guidance

GF	Plain-bearing guide
KF	Recirculating ball bearing guide

Guide units FEN/FENG for ISO cylinders

Technical data



FEN to ISO 6432



- \varnothing - Diameter
8 ... 25 mm

- | - Stroke length
1 ... 250 mm

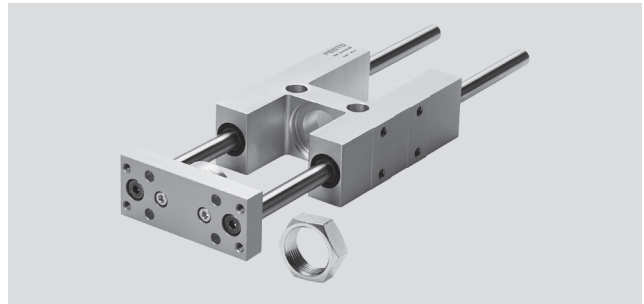

FENG to ISO 15552

- \varnothing - Diameter
32 ... 100 mm

- | - Stroke length
10 ... 500 mm

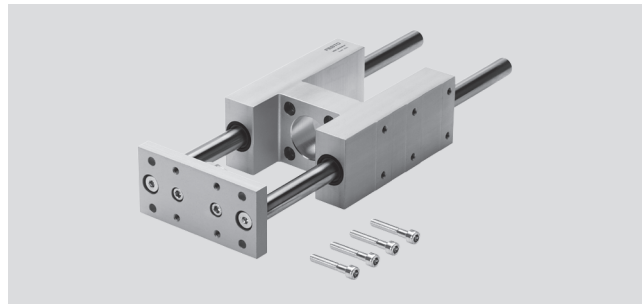

General technical data											
Type	FEN-...					FENG-...					
Piston diameter	8, 10	12, 16	20	25	32	40	50	63	80	100	
Stroke [mm]	1 ... 100	1 ... 200	2 ... 250		10 ... 500						
Design	Guide										
Guidance											
FEN/FENG-...-GF	Plain-bearing guide										
FEN/FENG-...-KF	Recirculating ball bearing guide										
Displacement force											
FEN/FENG-...-GF [N]	15	15	15	15	30	30	50	50	70	70	
FEN/FENG-...-KF [N]	15	15	15	15	15	15	15	15	15	40	40
Type of mounting	Via female thread										
Mounting position	Any										
Ambient temperature [°C]	-20 ... +80 °C										

Weight [g] (for calculation example → page 8)											
Type	FEN-...					FENG-...					
Piston diameter	8, 10	12, 16	20	25	32	40	50	63	80	100	
Plain-bearing guide (GF)											
Basic weight with 0 mm stroke	332	490	873	866	1570	2480	4190	5540	10720	13420	
Additional weight per 10 mm stroke	8	12	12	12	17	31	48	48	76	76	
Moving mass with 0 mm stroke	90	161	269	269	478	782	1414	1720	4955	5935	
Additional mass per 10 mm stroke	8	12	12	12	17	31	48	48	76	76	
Recirculating ball bearing guide (KF)											
Basic weight with 0 mm stroke	300	429	828	813	1530	2370	4030	5410	10430	12990	
Additional weight per 10 mm stroke	8	12	12	12	18	32	49	49	77	77	
Moving mass with 0 mm stroke	90	161	269	269	483	792	1430	1739	4990	5970	
Additional mass per 10 mm stroke	8	12	12	12	18	32	49	49	77	77	

Guide units FEN/FENG for ISO cylinders

Technical data

Centre of gravity of the moving mass [mm] (for calculation example → page 8)										
Type	FEN-...				FENG-...					
Piston diameter	8, 10	12, 16	20	25	32	40	50	63	80	100
With 0 mm stroke	30	40	42	42	43	57	60	69	54	47
Supplement per 10 mm stroke	4.9	4.9	4.7	4.7	4.5	4.7	4.7	4.6	3.9	3.6

Materials

Sectional view

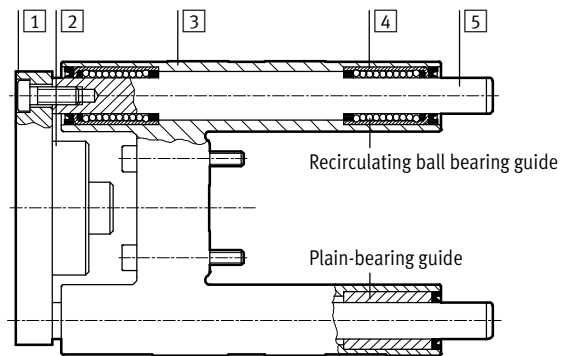

Guide unit	FEN/FENG-...-GF	FEN/FENG-...-KF
1 Yoke plate		
Piston diameter 32 ... 63	Aluminium	Aluminium
Piston diameter 80, 100	Steel	Steel
2 Coupling	Steel	Steel
3 Guide	Aluminium	Aluminium
4 Bearing	Sintered bronze	Steel
5 Guide rods	Steel	Steel
- Note on materials	-	Free of copper and PTFE
	RoHS compliant	

Guide units FEN/FENG for ISO cylinders

Technical data



Characteristic load value for FEN-...-KF/FENG-...-KF

The indicated forces and torques refer to the guide centre.

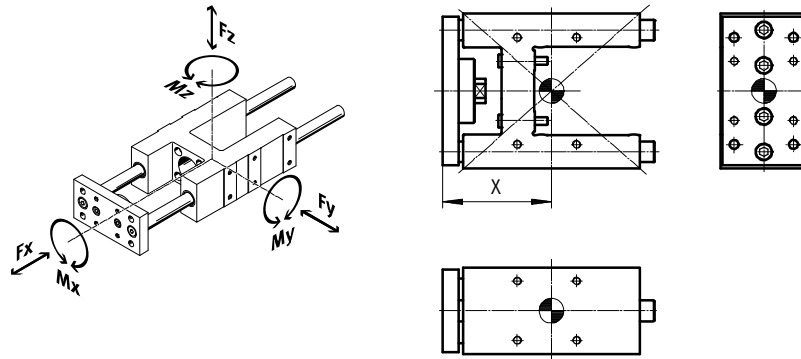

If the guide unit is subjected to two or more of the indicated forces and torques simultaneously, the following equation must be satisfied in addition to the indicated maximum loads.

Calculating the load comparison factor:

$$f_v = \frac{|F_{y,dyn}|}{F_{y,max}} + \frac{|F_{z,dyn}|}{F_{z,max}} + \frac{|M_{x,dyn}|}{M_{x,max}} + \frac{|M_{y,dyn}|}{M_{y,max}} + \frac{|M_{z,dyn}|}{M_{z,max}} \leq 1$$

Distance X (for calculation example → page 8)

Type	FEN-...-KF			FENG-...-KF					
Piston diameter	8, 10	12, 16	20, 25	32	40	50	63	80	100
Dimension X	55	68	69	83	85	99	117	142	145

Max. permissible forces and torques

Type	FEN-...-KF			FENG-...-KF					
Piston diameter	8, 10	12, 16	20, 25	32	40	50	63	80	100
Static									
F _{y,max} /F _{z,max}	680	830	830	1020	1260	1600	1600	3120	3120
M _{x,max}	16	20	24	38	55	83	95	231	268
M _{y,max} /M _{z,max}	7	12	31	46	65	89	115	259	267
Dynamic (for a service life of 5000 km)									
F _{y,max} /F _{z,max}	450	520	520	750	1000	1260	1260	2300	2300
M _{x,max}	11	12	15	28	44	65	75	170	198
M _{y,max} /M _{z,max}	5	7	20	34	52	70	90	191	197

Guide units FEN/FENG for ISO cylinders

Technical data

Calculating the service life

The service life of the guide depends on the load. To provide a rough indication of the service life of the guide,

the graph below plots the load comparison factor f_v against the service life ratio q .

These values are only theoretical. You must consult your local Festo contact

for load comparison factors f_v greater than 1.5.

Load comparison factor f_v as a function of service life ratio q

Example:

The effect on the service life, deviating from the specified reference service

life, can be determined by means of the service life ratio q :

Given:

Reference service life = 5000 km

Required service life = 3000 km

$$q = \frac{3000\text{km}}{5000\text{km}} = 0.6$$

The graph gives a load comparison factor f_v of 1.2. This means that the permissible resultant load can be utilised up to 120%.

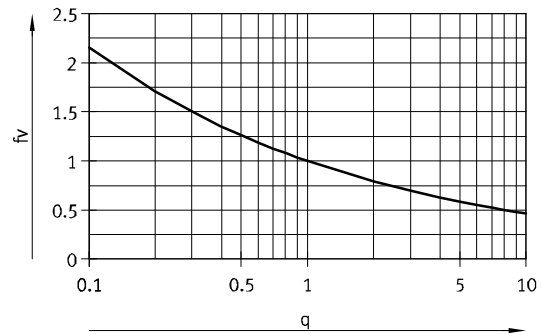

 Note

PositioningDrives
engineering software
www.festo.com

$f_v > 1.5$ are only theoretical comparison values.

Guide units FEN/FENG for ISO cylinders

Technical data

FESTO

Calculation example

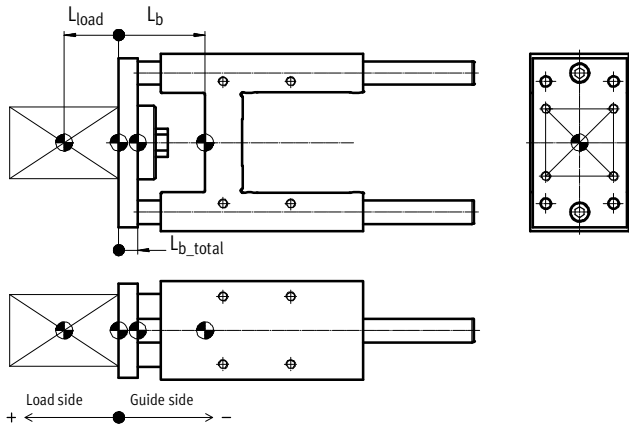

L_b = Centre of gravity of the moving mass of the guide unit

L_{load} = Centre of gravity of the payload

L_{b_total} = Centre of gravity of the total moving mass

Length measurements should be provided with plus/minus signs as shown in the figure:

$L_{b_total} > 0$ = Centre of gravity of the moving mass is on the payload side

$L_{b_total} < 0$ = Centre of gravity of the moving mass is on the guide side

Given:

- Guide unit: FENG-32-200-KF
- Stroke length: $H = 200$ mm
- Centre of gravity of payload $L_{load} = 15$ mm
- Payload: $m_{load} = 5$ kg
- Acceleration: $a_x = a_y = 2$ m/s², $a_z = 0$ m/s²

To be calculated:

- Loads F_{y_dyn}/F_{z_dyn} and $M_{x_dyn}/M_{y_dyn}/M_{z_dyn}$
- Verification of operation with combined load
- Expected service life

Solution:

Moving load:

$$m_{b_total} = m_b + m_{load} \quad (m_b = m_{0b} + H \times m_{Hb})$$

From table → page 4

$$m_{0b} = 0.483$$
 kg

$$m_{Hb} = 0.018$$
 kg/10 mm

$$m_b = 0.483$$
 kg + 200 mm x 0.018 kg/10 mm = 0.843 kg

$$m_{b_total} = 0.843$$
 kg + 5 kg = 5.843 kg

m_b = Moving mass of the guide unit

m_{0b} = Moving mass with 0 mm stroke

m_{Hb} = Additional mass per 10 mm stroke

H = Stroke length

Centre of gravity of the moving mass

$$L_{b_total} = \frac{L_{load} \times m_{load} + L_b \times m_b}{m_{b_total}} \quad (L_b = L_{0b} + H \times L_{Hb})$$

From table → page 5

$$L_{0b} = 43$$
 mm

$$L_{Hb} = 4.5$$
 mm/10 mm

$$L_b = 43$$
 mm + 200 mm x 4.5 mm/10 mm = 133 mm

$$L_{b_total} = \frac{(+ 15 \text{ mm}) \times 5 \text{ kg} + (- 133 \text{ mm}) \times 0.843 \text{ kg}}{5.843 \text{ kg}} = - 6 \text{ mm}$$

L_b = Centre of gravity of the moving mass of the guide unit

m_b = Moving mass of the guide unit

L_{load} = Centre of gravity of the payload

m_{load} = Payload

L_{0b} = Centre of gravity of the moving mass with 0 mm stroke

L_{Hb} = Additional centre of gravity of the moving mass per 10 mm stroke

Length measurements should be provided with plus/minus signs as shown in the figure:

$L_{b_total} > 0$ = Centre of gravity of the moving mass is on the payload side

$L_{b_total} < 0$ = Centre of gravity of the moving mass is on the guide side

Guide units FEN/FENG for ISO cylinders

Technical data

Calculation example

Loads $F_{y,dyn}/F_{z,dyn}$ and $M_{x,dyn}/M_{y,dyn}/M_{z,dyn}$

$$F_{y,dyn} = m_{b_total} \times a_y = 5.843 \text{ kg} \times 2 \text{ m/s}^2 = 12 \text{ N}$$

$$F_{z,dyn} = m_{b_total} \times (g + a_z) = 5.843 \text{ kg} \times (9.81 \text{ m/s}^2 + 0 \text{ m/s}^2) = 57 \text{ N}$$

From table → page 6

Dimension X = 83 mm

$$M_{y,dyn} = F_{z,dyn} \times (\text{dimension X} + \text{stroke} + L_{b_total}) = 57 \text{ N} \times (83 \text{ mm} + 200 \text{ mm} + (-6 \text{ mm})) = 16 \text{ Nm}$$

$$M_{z,dyn} = F_{y,dyn} \times (\text{dimension X} + \text{stroke} + L_{b_total}) = 12 \text{ N} \times (83 \text{ mm} + 200 \text{ mm} + (-6 \text{ mm})) = 3 \text{ Nm}$$

Verification of operation with combined load

Max values from table → page 6

$$F_{y,max} = 750 \text{ N} \quad M_{x,max} = 28 \text{ Nm}$$

$$F_{z,max} = 750 \text{ N} \quad M_{y,max} = 34 \text{ Nm}$$

$$M_{z,max} = 34 \text{ Nm}$$

$$f_v = \frac{|F_{y,dyn}|}{F_{y,max}} + \frac{|F_{z,dyn}|}{F_{z,max}} + \frac{|M_{x,dyn}|}{M_{x,max}} + \frac{|M_{y,dyn}|}{M_{y,max}} + \frac{|M_{z,dyn}|}{M_{z,max}} \leq 1$$

$$f_v = \frac{12 \text{ N}}{750 \text{ N}} + \frac{57 \text{ N}}{750 \text{ N}} + \frac{0 \text{ Nm}}{28 \text{ Nm}} + \frac{16 \text{ Nm}}{34 \text{ Nm}} + \frac{3 \text{ Nm}}{34 \text{ Nm}} = 0.7 \leq 1$$

Expected service life

$$L_{calc} = \frac{L_{ref}}{f_v^3} = \frac{5000 \text{ km}}{0.7^3} = 14000 \text{ km}$$

Guide units FEN/FENG for ISO cylinders

Technical data

Max. payload F and torque M as a function of cantilever load A

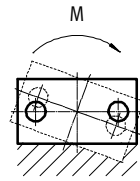
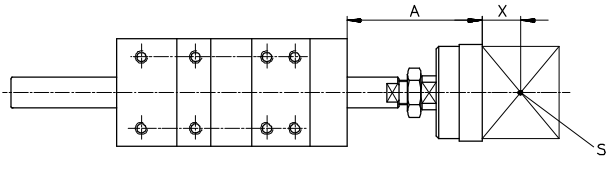

- A = Cantilever load
- X = Distance to centre of gravity of the payload
- S = Centre of gravity of the payload
- M = Torque

Explanation of how to read graphs in the case of a combined load

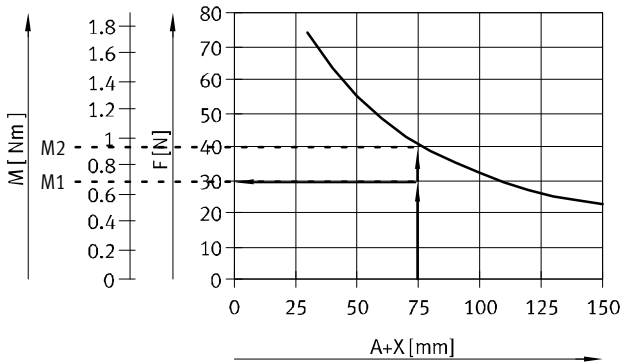

- Determine cantilever load (75 mm)
- Enter proportion that is payload (30 N)
- Enter distance from curve
- Permitted torque is the difference between M2 and M1

FEN... with plain-bearing guide

Piston diameter 8/10

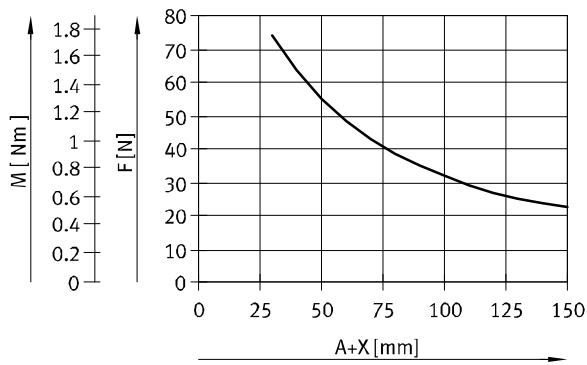

Piston diameter 12/16

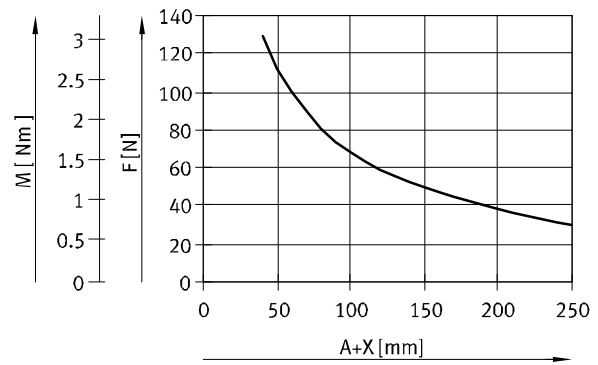

Piston diameter 20/25

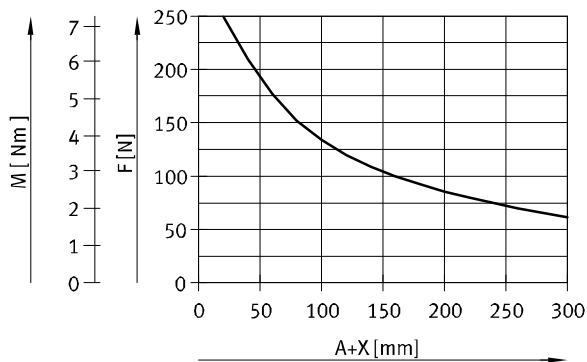

Guide units FEN/FENG for ISO cylinders

Technical data

Max. payload F and torque M as a function of cantilever load A

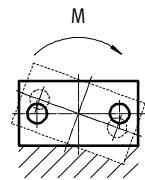
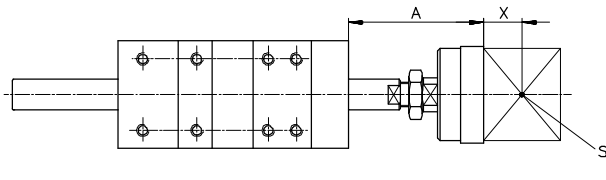

- A = Cantilever load
- X = Distance to centre of gravity of the payload
- S = Centre of gravity of the payload
- M = Torque

FENG... with plain-bearing guide

Piston diameter 32

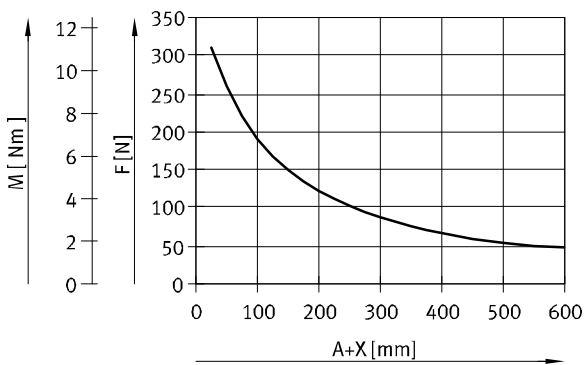

Piston diameter 40

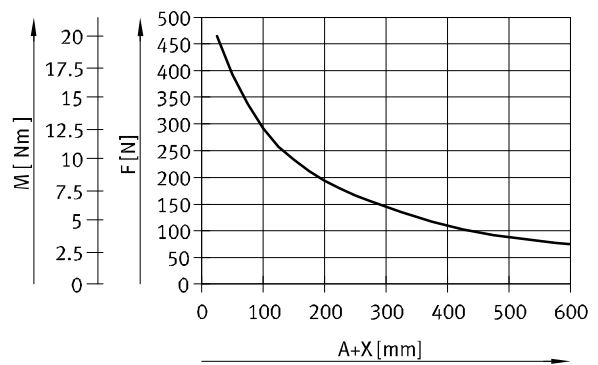

Piston diameter 50

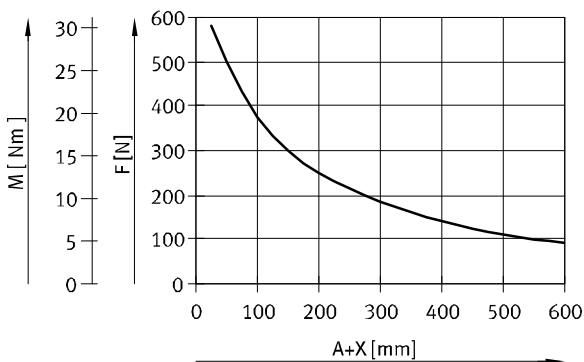

Piston diameter 63

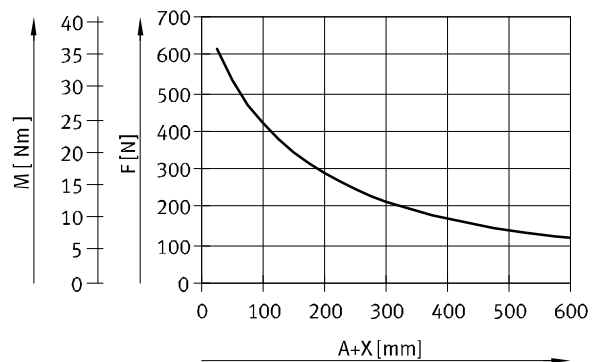

Piston diameter 80

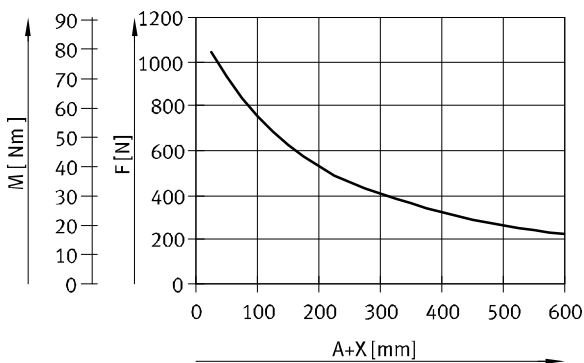

Piston diameter 100

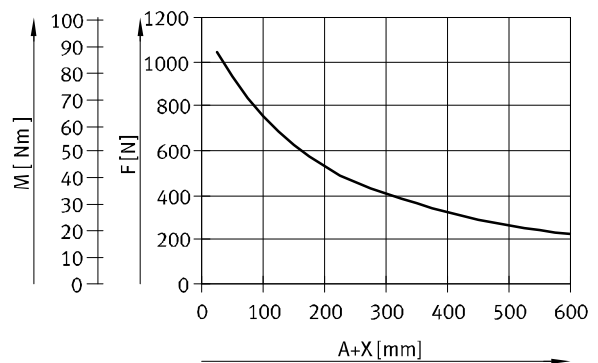

Guide units FEN/FENG for ISO cylinders

Technical data

Max. payload F and torque M as a function of cantilever load A

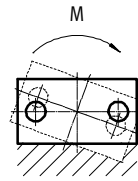
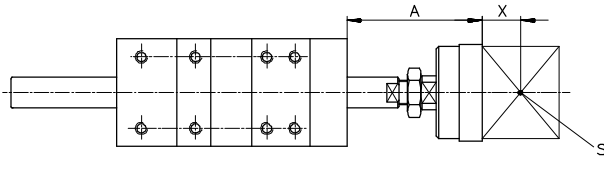

- A = Cantilever load
- X = Distance to centre of gravity of the payload
- S = Centre of gravity of the payload
- M = Torque

FEN... with recirculating ball bearing guide

Piston diameter 8/10

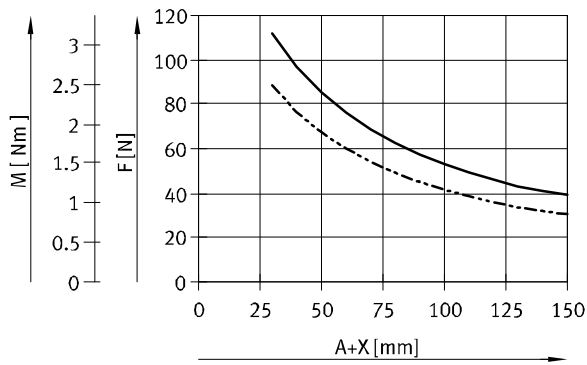

- Running performance of 1500 km
- - - Running performance of 3000 km

Piston diameter 12/16

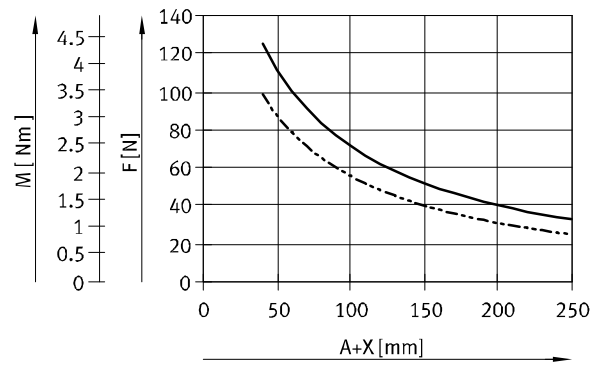

- Running performance of 1500 km
- - - Running performance of 3000 km

Piston diameter 20/25

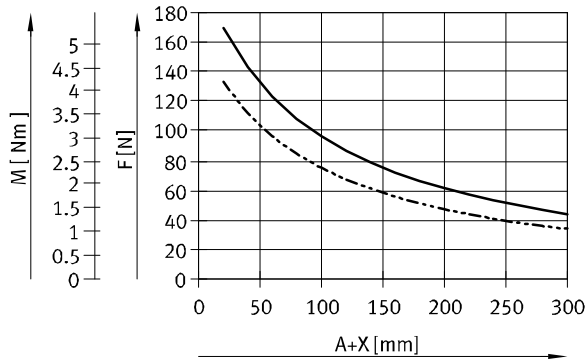

- Running performance of 5000 km
- - - Running performance of 10000 km

Guide units FEN/FENG for ISO cylinders

Technical data

Max. payload F and torque M as a function of cantilever load A

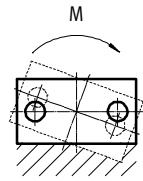
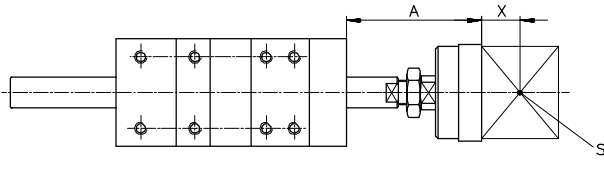

- A = Cantilever load
- X = Distance to centre of gravity of the payload
- S = Centre of gravity of the payload
- M = Torque

FENG... with recirculating ball bearing guide

Piston diameter 32

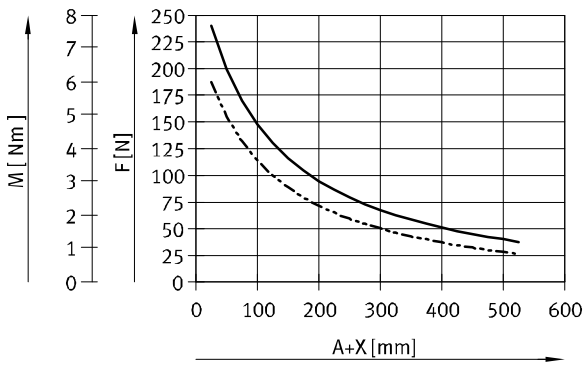

Piston diameter 40

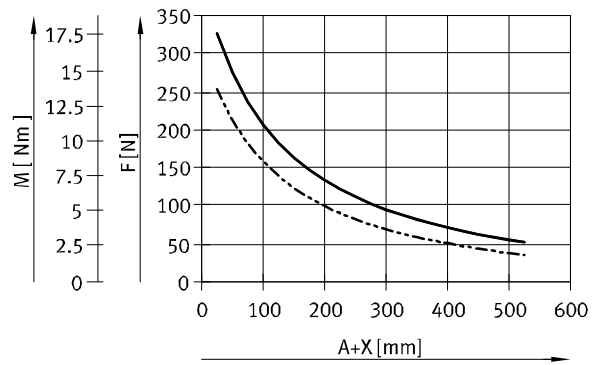

Piston diameter 50

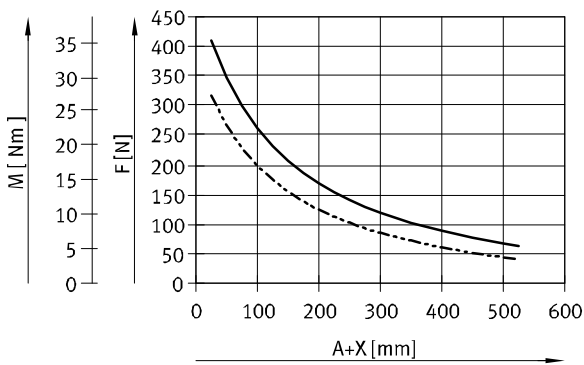

Piston diameter 63

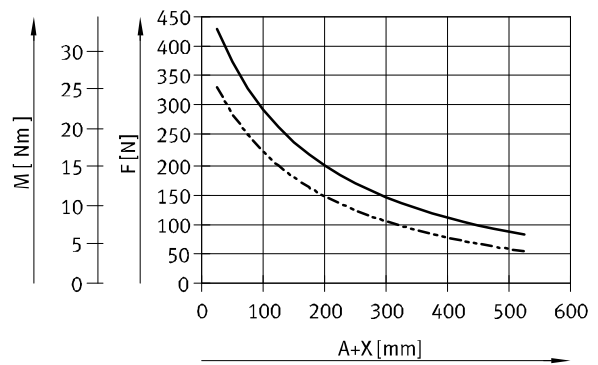

Piston diameter 80

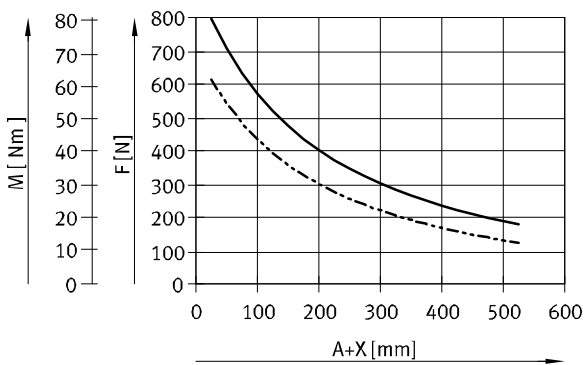

Piston diameter 100

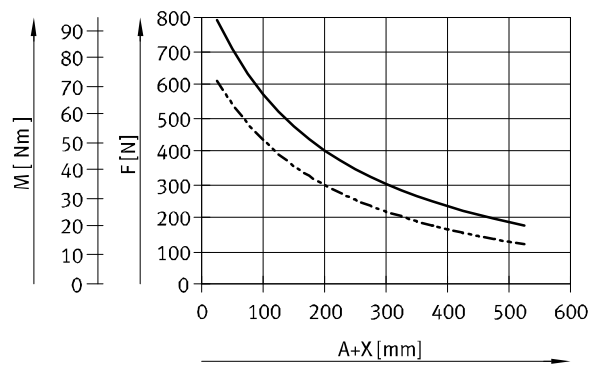

- Running performance of 5000 km
- - - - - Running performance of 10000 km

Guide units FEN/FENG for ISO cylinders

Technical data

Deflection f_{tare} (due to tare weight) as a function of cantilever load A

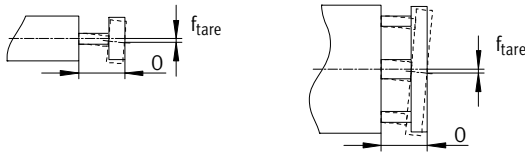

FEN...

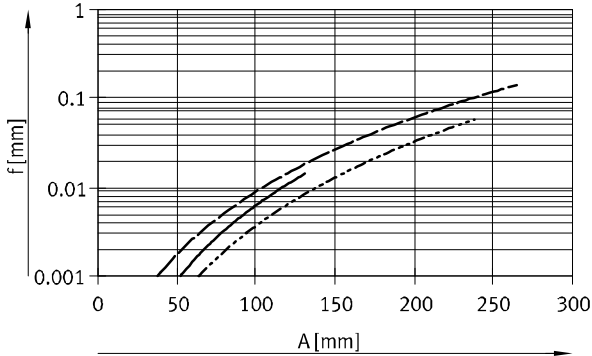

- FEN-8/10-...-GF/KF
- - - FEN-12/16-...-GF/KF
- · - FEN-20/25-...-GF/KF

FENG...

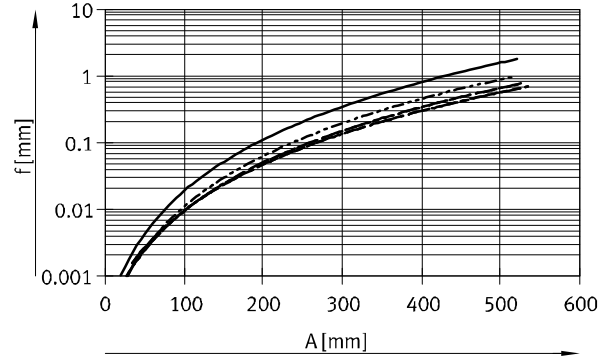

- FENG-32-...-GF/KF
- - - FENG-40-...-GF/KF
- · - FENG-50/63-...-GF/KF
- · - FENG-80/100-...-GF/KF

Deflection $f_{standard}$ (due to lateral force) as a function of cantilever load A

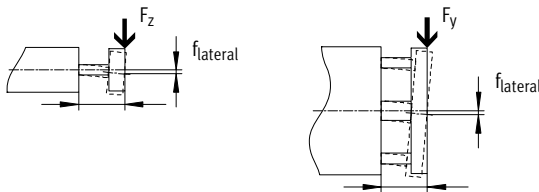

The maximum permissible lateral force must not be exceeded.

$$f_{lateral} = \frac{F_{lateral}}{F_{standard}} \times f_{standard}$$

$$F_{standard} = 10 \text{ N}$$

- A = Cantilever load of guide rod
- $f_{lateral}$ = Deflection due to lateral force
- $F_{lateral}$ = Lateral force
- $F_{standard}$ = Standardised lateral force
- $f_{standard}$ = Deflection due to standardised lateral force (value from graph)

FEN...

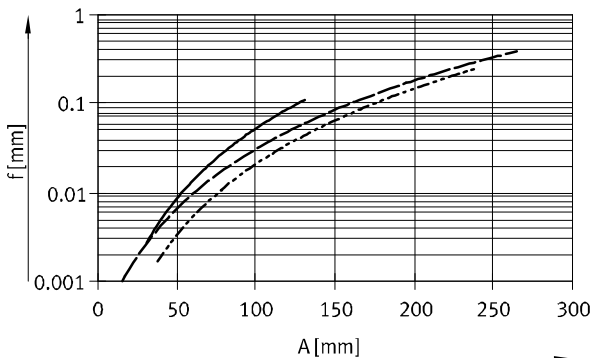

- FEN-8/10-...-GF/KF
- - - FEN-12/16-...-GF/KF
- · - FEN-20/25-...-GF/KF

FENG...

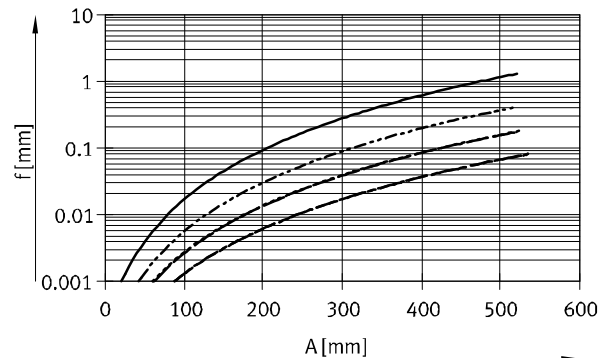

- FENG-32-...-GF/KF
- - - FENG-40-...-GF/KF
- · - FENG-50/63-...-GF/KF
- · - FENG-80/100-...-GF/KF

Guide units FEN/FENG for ISO cylinders

Technical data

Inclination α (due to torque) as a function of cantilever load A

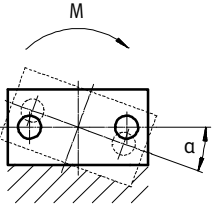

$$\alpha = \frac{M}{M_{\text{standard}}} \times \alpha_{\text{standard}}$$

$M_{\text{standard}} = 2 \text{ Nm}$
(valid for $\alpha \leq 10^\circ$)

- A = Cantilever load of guide rod
- α = Inclination due to torque
- M = Torque
- M_{standard} = Standardised torque
- α_{standard} = Deflection due to standardised torque

FEN...

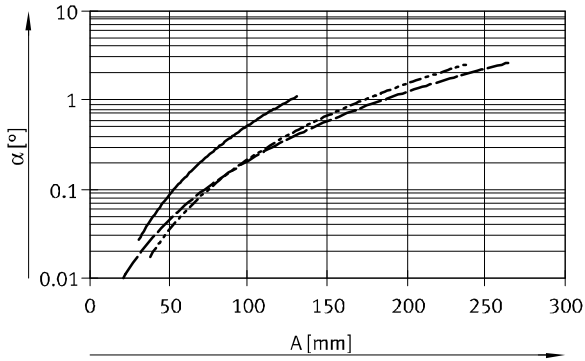

- FEN-8/10-...-GF/KF
- - - FEN-12/16-...-GF/KF
- · - FEN-20/25-...-GF/KF

FENG...

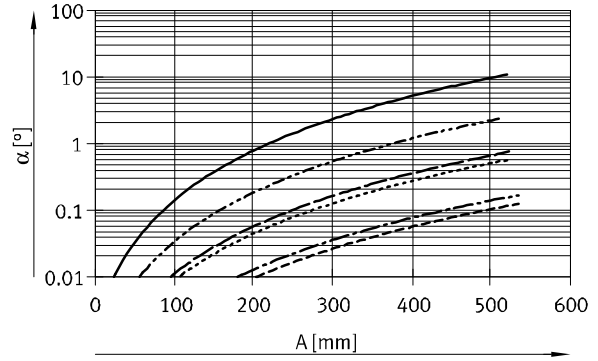

- FENG-32-...-GF/KF
- - - FENG-40-...-GF/KF
- · - FENG-50-...-GF/KF
- · · - FENG-63-...-GF/KF
- · · - FENG-80-...-GF/KF
- · · - FENG-100-...-GF/KF

Guide units FEN/FENG for ISO cylinders

Technical data



Dimensions

Download CAD data → www.festo.com

FEN-8, 10

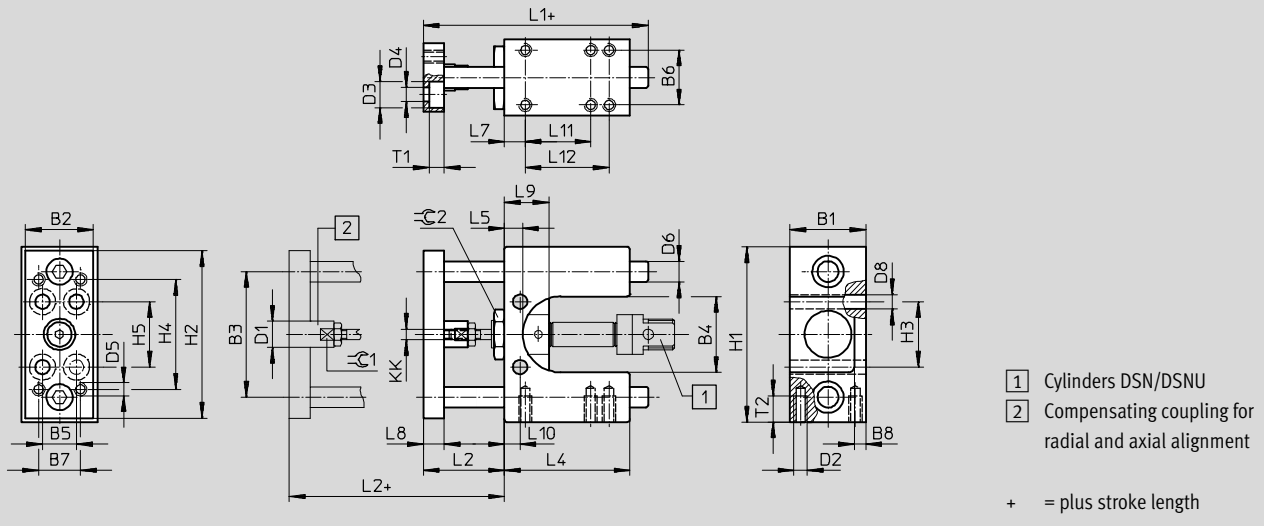

∅	B1	B2	B3	B4	B5	B6	B7	B8	D1	D2	D3	D4	D5	D6 ¹⁾	D8	H1	H2
[mm]	-0.3		±0.15						∅		∅	∅		∅	∅	-0.4	
8	29	26	48	29	13	21	16	4.5	10	M5	10	5.5	M5	8	5.5	67	64
10																	

∅	H3	H4	H5	KK	L1	L2	L4	L5	L7	L8	L9	L10	L11	L12	T1	T2	≈C1	≈C2
[mm]						+2												
8	25	42	25	M4	86	31	48	7	8	8	17	6	25	32	5.7	10	9	19
10																		

1) FEN-...-GF: Tolerance class f8
FEN-...-KF: Tolerance class h6

Guide units FEN/FENG for ISO cylinders

Technical data

Dimensions Download CAD data → www.festo.com

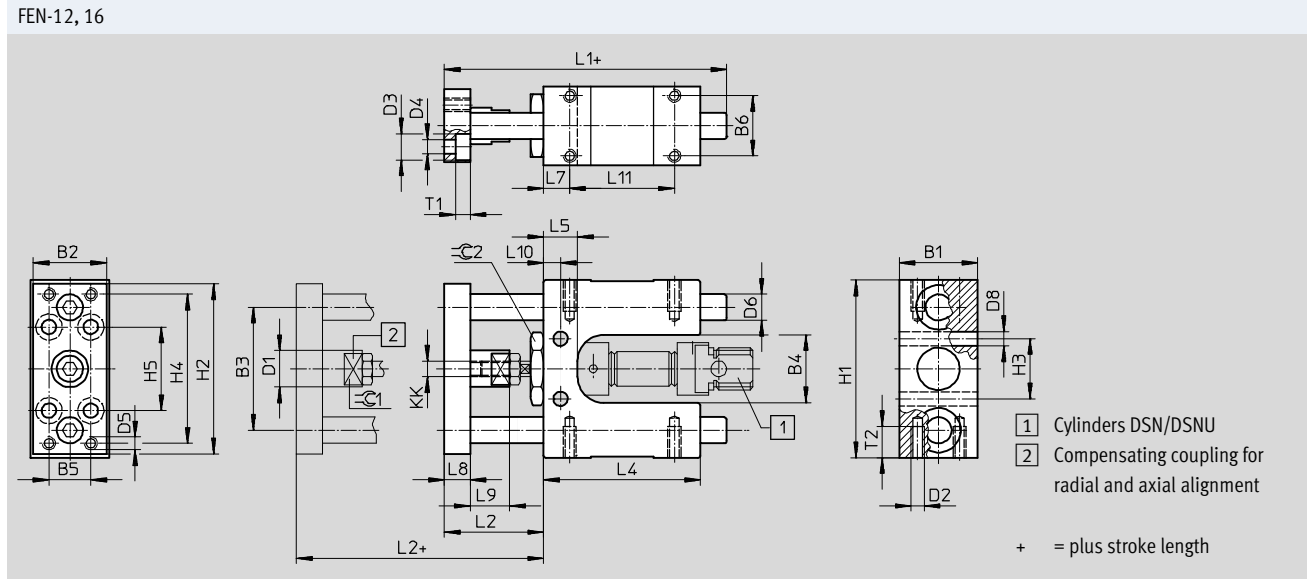

∅	B1	B2	B3	B4	B5	B6	D1	D2	D3	D4	D5	D6 ¹⁾	D8	H1	H2	H3
[mm]	-0.3		±0.15			±0.15	∅		∅	∅		∅	∅	-0.4		±0.15
12	30	28	47	26	16	23	14	M5	10	5.5	M5	10	5.5	68	65	23
16																

∅	H4	H5	KK	L1	L2	L4	L5	L7	L8	L9	L10	L11	T1	T2	⌀C1	⌀C2
[mm]					+5							±0.15				
12	57	32	M6	108	38	60	13	10	10	15	6.5	40	5.7	12	12	24
16																

1) FEN-...-GF: Tolerance class f8
FEN-...-KF: Tolerance class h6

Guide units FEN/FENG for ISO cylinders

Technical data



Dimensions Download CAD data → www.festo.com

FEN-20, 25

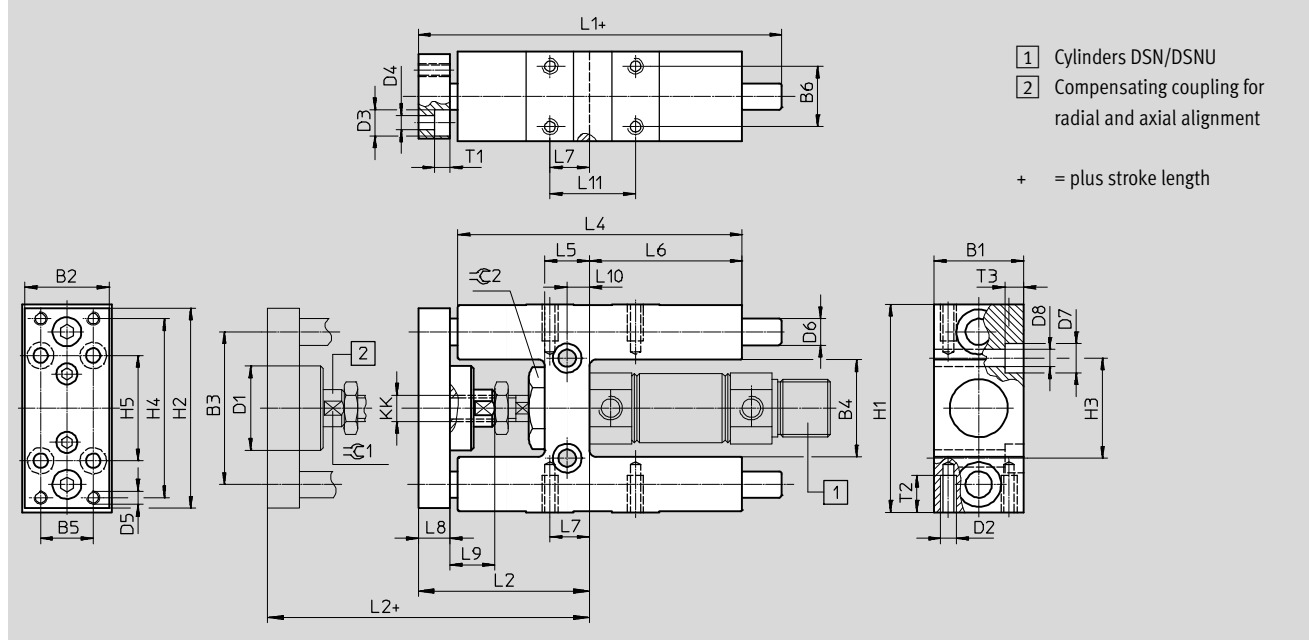

∅	B1	B2	B3	B4	B5	B6	D1	D2	D3	D4	D5	D6 ¹⁾	D7	D8	H1	H2	H3	H4
[mm]	-0.3		±0.2				∅		∅	∅		∅	∅	∅	-0.4		±0.2	
20	34	32	58	37	20	23	32	M6	10	5.5	M5	10	11	6.6	79	76	38	68
25																		

∅	H5	KK	L1	L2	L4	L5	L6	L7	L8	L9	L10	L11	T1	T2	T3	≈C1	≈C2
[mm]				+5								±0.2					
20	40	M8	138	65	108	17	58	15	12	22	8.5	32.5	5.7	14	6.8	13	27
25		M10x1.25															

1) FEN-...-GF: Tolerance class f8
FEN-...-KF: Tolerance class h6

Guide units FEN/FENG for ISO cylinders

Technical data



Dimensions

Download CAD data → www.festo.com

FENG-32 ... 100

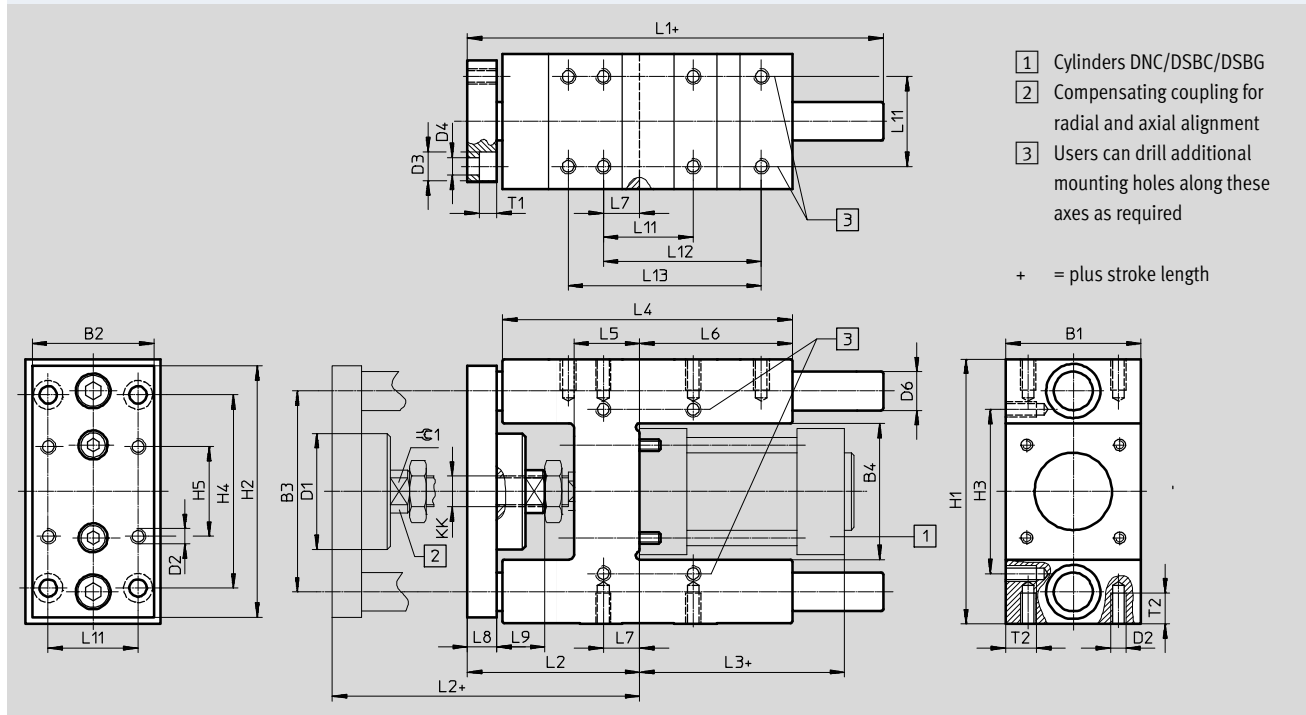

∅	B1	B2	B3	B4	D1	D2	D3	D4	D6 ¹⁾	H1	H2	H3	H4	H5	KK
[mm]	-0.3		±0.2		∅		∅	∅	∅			±0.2	±0.2	±0.2	
32	50	45	74	50.5 ±0.3	45	M6	11	6.6	12	97 -0.4	90	61	78	32.5	M10x1.25
40	58	54	87	58.5 ±0.3	45	M6	11	6.6	16	115 -0.4	110	69	84	38	M12x1.25
50	70	63	104	70.5 ±0.3	60	M8	15	9	20	137 -0.5	130	85	100	46.5	M16x1.5
63	85	80	119	85.5 ±0.3	60	M8	15	9	20	152 -0.5	145	100	105	56.5	M16x1.5
80	105	100	148	106 ±0.6	78	M10	18	11	25	189 -0.5	180	130	130	72	M20x1.5
100	130	120	172	131 ±0.6	78	M10	18	11	25	213 -0.5	200	150	150	89	M20x1.5

∅	L1	L2	L3	L4	L5	L6	L7	L8	L9	L11	L12	L13	T1	T2	≈C1
[mm]										±0.2	±0.2	±0.2		Max.	
32	155	67 +5	94	125	24	76	4.3	12	20	32.5	70.3	78	6.5	14	15
40	170	75 +5	105	140	28	81	11	12	22	38	84	-	6.5	14	15
50	188	89 +10	106	150	34	79	18.8	15	25	46.5	81.8	100	9	16	19
63	220	89 +10	121	182	34	111	15.3	15	25	56.5	105	-	9	16	19
80	258	111 +10	128	215	40	128	21	20	32	72	-	-	11	20	27
100	263	116 +10	138	220	40	128	24.5	20	32	89	-	-	11	20	27

1) FENG-...-GF: Tolerance class f8
 FENG-...-KF: Tolerance class h6

Guide units FEN/FENG for ISO cylinders

Technical data

Ordering data FEN... for variable strokes for ISO cylinders DSNU					
Piston diameter [mm]	Stroke [mm]	With plain-bearing guide		With recirculating ball bearing guide	
		Part No.	Type	Part No.	Type
8, 10	1 ... 100	35196	FEN-8/10-...-GF	35197	FEN-8/10-...-KF
12, 16	1 ... 200	19168	FEN-12/16-...-GF	33481	FEN-12/16-...-KF
20	2 ... 250	19169	FEN-20-...-GF	33482	FEN-20-...-KF
25	2 ... 250	19170	FEN-25-...-GF	33483	FEN-25-...-KF

Ordering data FENG... for variable strokes for ISO cylinders DNC/DSBC/DSBG					
Piston diameter [mm]	Stroke [mm]	With plain-bearing guide		With recirculating ball bearing guide	
		Part No.	Type	Part No.	Type
32	10 ... 500	34481	FENG-32-...-GF	34487	FENG-32-...-KF
40		34482	FENG-40-...-GF	34488	FENG-40-...-KF
50		34483	FENG-50-...-GF	34489	FENG-50-...-KF
63		34484	FENG-63-...-GF	34490	FENG-63-...-KF
80		34485	FENG-80-...-GF	34491	FENG-80-...-KF
100		34486	FENG-100-...-GF	34492	FENG-100-...-KF

Ordering data FENG-...-KF with recirculating ball bearing guide for fixed strokes for ISO cylinders DNC/DSBC/DSBG									
Piston diameter [mm]	Stroke	50 mm		100 mm		160 mm		200 mm	
		Part No.	Type	Part No.	Type	Part No.	Type	Part No.	Type
32	50 mm	34493	FENG-32-50-KF	34494	FENG-32-100-KF	34495	FENG-32-160-KF	34496	FENG-32-200-KF
40	50 mm	34499	FENG-40-50-KF	34500	FENG-40-100-KF	34501	FENG-40-160-KF	34502	FENG-40-200-KF
50	50 mm	34506	FENG-50-50-KF	34507	FENG-50-100-KF	34508	FENG-50-160-KF	34509	FENG-50-200-KF
63	50 mm	34513	FENG-63-50-KF	34514	FENG-63-100-KF	34515	FENG-63-160-KF	34516	FENG-63-200-KF
80	50 mm	34521	FENG-80-50-KF	34522	FENG-80-100-KF	34523	FENG-80-160-KF	34524	FENG-80-200-KF
100	50 mm	34529	FENG-100-50-KF	34530	FENG-100-100-KF	34531	FENG-100-160-KF	34532	FENG-100-200-KF
32	250 mm	150289	FENG-32-250-KF	34497	FENG-32-320-KF	150290	FENG-32-400-KF	34498	FENG-32-500-KF
40	250 mm	34503	FENG-40-250-KF	34504	FENG-40-320-KF	150291	FENG-40-400-KF	34505	FENG-40-500-KF
50	250 mm	34510	FENG-50-250-KF	34511	FENG-50-320-KF	150292	FENG-50-400-KF	34512	FENG-50-500-KF
63	250 mm	34517	FENG-63-250-KF	34518	FENG-63-320-KF	34519	FENG-63-400-KF	34520	FENG-63-500-KF
80	250 mm	34525	FENG-80-250-KF	34526	FENG-80-320-KF	34527	FENG-80-400-KF	34528	FENG-80-500-KF
100	250 mm	34533	FENG-100-250-KF	34534	FENG-100-320-KF	34535	FENG-100-400-KF	34536	FENG-100-500-KF

Festo - Your Partner in Automation



1 Festo Inc.

5300 Explorer Drive
Mississauga, ON L4W 5G4
Canada

Festo Customer Interaction Center

Tel: 1 877 463 3786
Fax: 1 877 393 3786
Email: customer.service.ca@festo.com



2 Festo Pneumatic

Av. Ceylán 3,
Col. Tequesquináhuac
54020 Tlalnepantla,
Estado de México

Multinational Contact Center

01 800 337 8669
ventas.mexico@festo.com



3 Festo Corporation

1377 Motor Parkway
Suite 310
Islandia, NY 11749

Festo Customer Interaction Center

1 800 993 3786
1 800 963 3786
customer.service.us@festo.com



4 Regional Service Center

7777 Columbia Road
Mason, OH 45040

Connect with us



www.festo.com/socialmedia



www.festo.com