

A768, Polymer Aluminum, 330 uF, 20%, 25 VDC, -55/+125°C

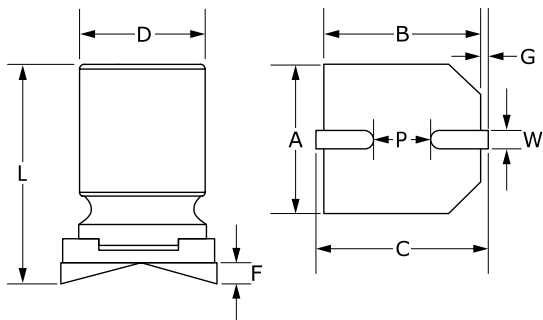

General Information	
Series:	A768
Dielectric:	Polymer Aluminum
Style:	SMD Can
Description:	Surface Mount, Polymer Aluminum
RoHS:	Yes
Lead:	V-Chip
AEC-Q200:	No
Halogen Free:	Yes

Dimensions	
D	8mm +/-0.5mm
L	12.2mm +/-0.3mm
W	0.8 - 1.1mm
F	0.2mm MAX
A	8.3mm +/-0.2mm
B	8.3mm +/-0.2mm
C	9mm +/-0.2mm
G	0.35mm +/-0.2mm
P	3.2mm NOM

Specifications	
Capacitance:	330 uF
Capacitance Tolerance:	20%
Voltage DC:	25 VDC, 28.7 VDC (Surge)
Temperature Range:	-55/+125°C
Rated Temperature:	125°C
Life:	2000 Hrs
Resistance:	19 mOhms (100kHz 20C)
Ripple Current:	2325 mAmps (100kHz 125C)
Leakage Current:	1650 uA (2min 20°C)
High Temperature Solder:	No

Packaging Specifications	
Packaging:	T&R, 380mm
Packaging Quantity:	400