

Ultrabright White LED, Ø 5 mm Untinted Non-Diffused Package

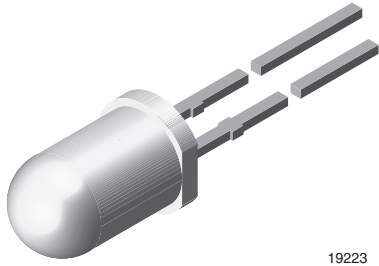

19223

DESCRIPTION

The VLHW5100 is a clear, non-diffused 5 mm LED for high end applications where supreme luminous intensity required.

These lamps with clear untinted plastic case utilize the highly developed ultrabright InGaN technologies.

The lens and the viewing angle is optimized to achieve best performance of light output and visibility.

PRODUCT GROUP AND PACKAGE DATA

- Product group: LED
- Package: 5 mm
- Product series: standard
- Angle of half intensity: $\pm 10^\circ$

FEATURES

- Untinted non-diffused lens
- Utilizing ultrabright InGaN technology
- High luminous intensity
- Luminous intensity and color categorized for each packing unit
- ESD-withstand voltage: Up to 4 kV according to JESD22-A114-B
- Circuit protection by Zener diode
- Material categorization: For definitions of compliance please see www.vishay.com/doc?99912



RoHS
COMPLIANT
HALOGEN
FREE
GREEN
(5-2008)

APPLICATIONS

- Interior and exterior lighting
- Outdoor LED panels
- Instrumentation and front panel indicators
- Replaces incandescent lamps
- Light guide compatible

PARTS TABLE

PART	COLOR	LUMINOUS INTENSITY (mcd)			at I _F (mA)	COORDINATE (x, y)			at I _F (mA)	FORWARD VOLTAGE (V)			at I _F (mA)	TECHNOLOGY
		MIN.	TYP.	MAX.		MIN.	TYP.	MAX.		MIN.	TYP.	MAX.		
VLHW5100	White	5600	-	11 200	20	-	0.33, 0.33	-	20	2.8	-	3.6	20	InGaN and converter
VLHW5100-CS12	White	5600	-	11 200	20	-	0.33, 0.33	-	20	2.8	-	3.6	20	InGaN and converter

ABSOLUTE MAXIMUM RATINGS (T_{amb} = 25 °C, unless otherwise specified)

VLHW5100

PARAMETER	TEST CONDITION	SYMBOL	VALUE	UNIT
Reverse voltage		V _R	5	V
DC forward current		I _F	30	mA
Peak forward current	at 1 kHz, t _p /T = 0.1	I _{FSM}	0.1	A
Power dissipation		P _V	100	mW
Zener reverse current		I _Z	100	mA
Junction temperature		T _j	100	°C
Operating temperature range		T _{amb}	- 40 to + 100	°C
Storage temperature range		T _{stg}	- 40 to + 100	°C
Soldering temperature	t ≤ 5 s	T _{sd}	260	°C
Thermal resistance junction/ambient		R _{thJA}	400	K/W



OPTICAL AND ELECTRICAL CHARACTERISTICS (T _{amb} = 25 °C, unless otherwise specified)							
WHITE VLHW5100							
PARAMETER	TEST CONDITION	PART	SYMBOL	MIN.	TYP.	MAX.	UNIT
Luminous intensity	I _F = 20 mA	VLHW5100	I _V	5600	-	11 200	mcd
Chromaticity coordinate x acc. to CIE 1931	I _F = 20 mA		x	-	0.33	-	
Chromaticity coordinate y acc. to CIE 1931	I _F = 20 mA		y	-	0.33	-	
Angle of half intensity	I _F = 20 mA		φ	-	± 10	-	deg
Forward voltage	I _F = 20 mA		V _F	2.8	-	3.6	V
Reverse current	V _R = 5 V		I _R	-	-	50	μA
Temperature coefficient of V _F	I _F = 20 mA		TC _{V_F}	-	- 4	-	mV/K
Temperature coefficient of I _V	I _F = 20 mA		TC _{I_V}	-	- 0.5	-	% / K

CHROMATICITY COORDINATED CLASSIFICATION				
GROUP	X		Y	
	MIN.	MAX.	MIN.	MAX.
3A	0.2900	0.3025	y = 1.4x - 0.121	y = 1.4x - 0.071
3B	0.3025	0.3150	y = 1.4x - 0.121	y = 1.4x - 0.071
3C	0.2900	0.3025	y = 1.4x - 0.171	y = 1.4x - 0.121
3D	0.3025	0.3150	y = 1.4x - 0.171	y = 1.4x - 0.121
4A	0.3150	0.3275	y = 1.4x - 0.121	y = 1.4x - 0.071
4B	0.3275	0.3400	y = 1.4x - 0.121	y = 1.4x - 0.071
4C	0.3150	0.3275	y = 1.4x - 0.171	y = 1.4x - 0.121
4D	0.3275	0.3400	y = 1.4x - 0.171	y = 1.4x - 0.121
5A	0.3400	0.3525	y = 1.4x - 0.121	y = 1.4x - 0.071
5B	0.3525	0.3650	y = 1.4x - 0.121	y = 1.4x - 0.071
5C	0.3400	0.3525	y = 1.4x - 0.171	y = 1.4x - 0.121
5D	0.3525	0.3650	y = 1.4x - 0.171	y = 1.4x - 0.121

Note

- Chromaticity coordinate groups are tested with a tolerance of ± 0.01.

LUMINOUS INTENSITY CLASSIFICATION		
GROUP	LIGHT INTENSITY (mcd)	
	MIN.	MAX.
DB	5600	7100
EA	7100	9000
EB	9000	11 200

Note

- Luminous intensity is tested with an accuracy of ± 11 %.
- The above type numbers represent the order groups which include only a few brightness groups. Only one group will be shipped on each reel (there will be no mixing of two groups on each reel). In order to ensure availability, single brightness groups will not be orderable.
- In a similar manner for colors where color groups are measured and binned, single color groups will be shipped on any one reel. In order to ensure availability, single color groups will not be orderable.

FORWARD VOLTAGE CLASSIFICATION		
GROUP	FORWARD VOLTAGE (V)	
	MIN.	MAX.
0	2.8	3.0
1	3.0	3.2
2	3.2	3.4
3	3.4	3.6

Note

- Forward voltage is tested with an accuracy of ± 0.1 V.

TYPICAL CHARACTERISTICS ($T_{amb} = 25\text{ }^{\circ}\text{C}$, unless otherwise specified)

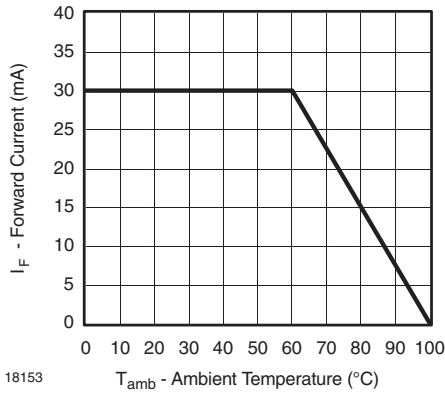

Fig. 1 - Forward Current vs. Ambient Temperature

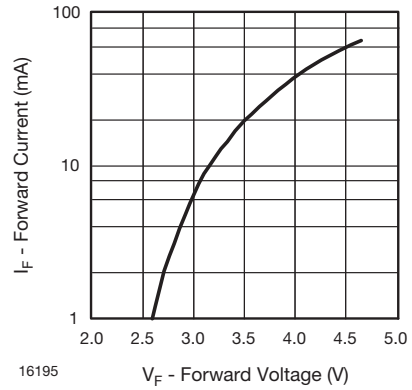

Fig. 4 - Forward Current vs. Forward Voltage

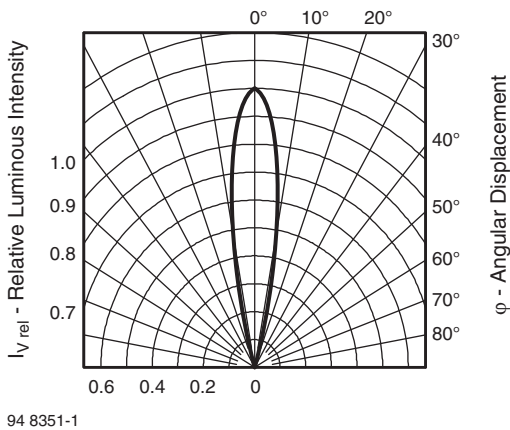

Fig. 2 - Relative Luminous Intensity vs. Angular Displacement

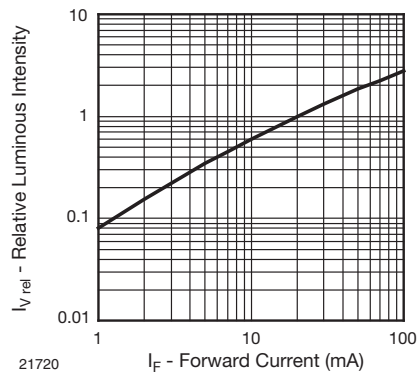

Fig. 5 - Relative Luminous Flux vs. Forward Current

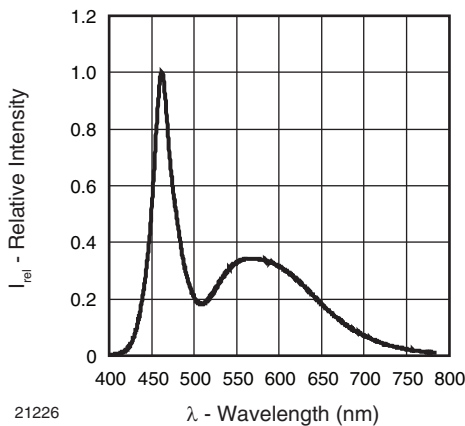

Fig. 3 - Relative Intensity vs. Wavelength

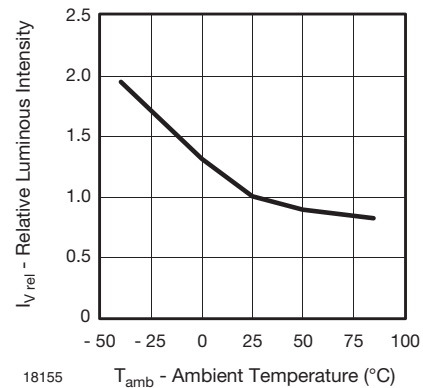

Fig. 6 - Relative Luminous Intensity vs. Ambient Temperature

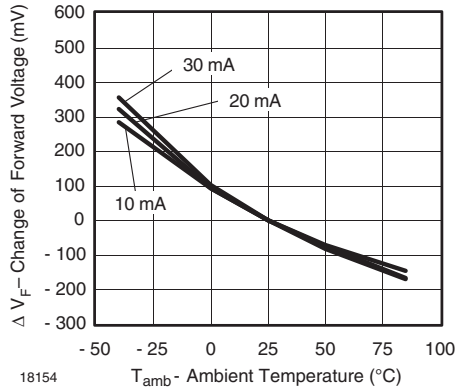

Fig. 7 - Change of Forward Voltage vs. Ambient Temperature

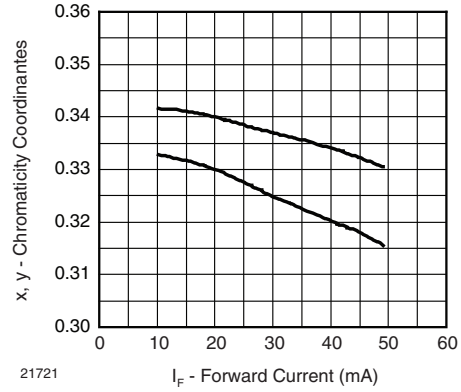

Fig. 9 - Chromaticity Coordinate Shift vs. Forward Current

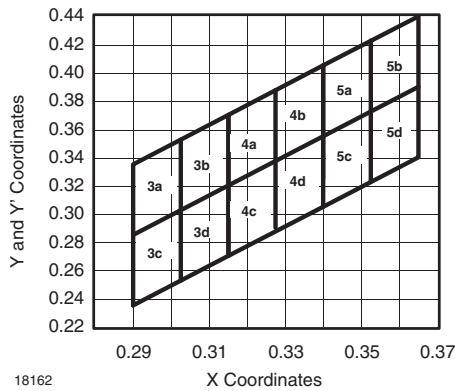
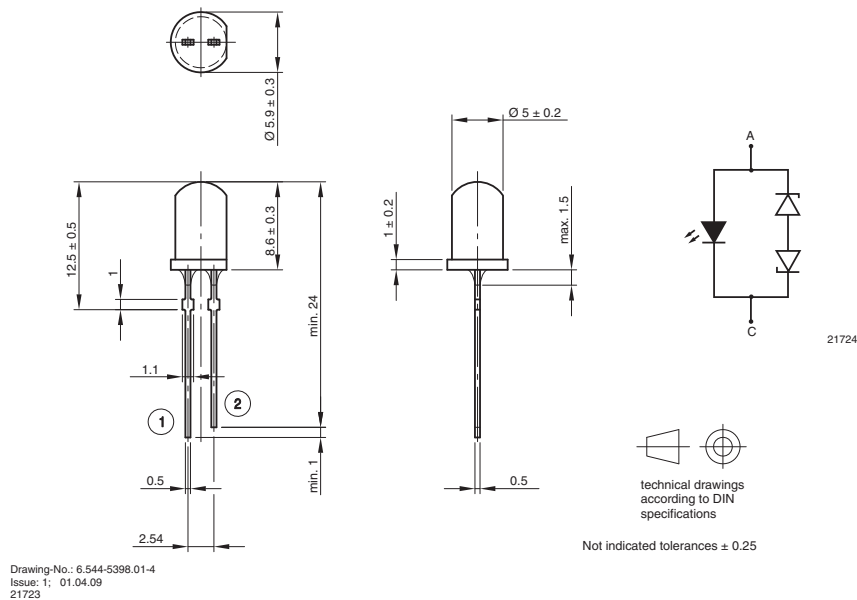

Fig. 8 - Coordinates of Colorgroups

PACKAGE DIMENSIONS in millimeters





BAR CODE PRODUCT LABEL

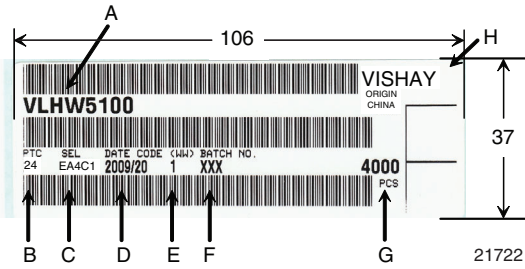

- A) Type of component
- B) Manufacturing plant
- C) SEL - selection code (bin):
 - e.g.: EA = code for luminous intensity group
 - 4C = code for chromaticity coordinate
 - 1 = code for forward voltage
- D) Date code year/week
- E) Day code (e.g. 1: Monday)
- F) Batch no.
- G) Total quantity
- H) Company code



Disclaimer

ALL PRODUCT, PRODUCT SPECIFICATIONS AND DATA ARE SUBJECT TO CHANGE WITHOUT NOTICE TO IMPROVE RELIABILITY, FUNCTION OR DESIGN OR OTHERWISE.

Vishay Intertechnology, Inc., its affiliates, agents, and employees, and all persons acting on its or their behalf (collectively, "Vishay"), disclaim any and all liability for any errors, inaccuracies or incompleteness contained in any datasheet or in any other disclosure relating to any product.

Vishay makes no warranty, representation or guarantee regarding the suitability of the products for any particular purpose or the continuing production of any product. To the maximum extent permitted by applicable law, Vishay disclaims (i) any and all liability arising out of the application or use of any product, (ii) any and all liability, including without limitation special, consequential or incidental damages, and (iii) any and all implied warranties, including warranties of fitness for particular purpose, non-infringement and merchantability.

Statements regarding the suitability of products for certain types of applications are based on Vishay's knowledge of typical requirements that are often placed on Vishay products in generic applications. Such statements are not binding statements about the suitability of products for a particular application. It is the customer's responsibility to validate that a particular product with the properties described in the product specification is suitable for use in a particular application. Parameters provided in datasheets and / or specifications may vary in different applications and performance may vary over time. All operating parameters, including typical parameters, must be validated for each customer application by the customer's technical experts. Product specifications do not expand or otherwise modify Vishay's terms and conditions of purchase, including but not limited to the warranty expressed therein.

Except as expressly indicated in writing, Vishay products are not designed for use in medical, life-saving, or life-sustaining applications or for any other application in which the failure of the Vishay product could result in personal injury or death. Customers using or selling Vishay products not expressly indicated for use in such applications do so at their own risk. Please contact authorized Vishay personnel to obtain written terms and conditions regarding products designed for such applications.

No license, express or implied, by estoppel or otherwise, to any intellectual property rights is granted by this document or by any conduct of Vishay. Product names and markings noted herein may be trademarks of their respective owners.