

BC817; BC817W; BC337

45 V, 500 mA NPN general-purpose transistors

Rev. 05 — 21 January 2005

Product data sheet

1. Product profile

1.1 General description

NPN general-purpose transistors.

Table 1: Product overview

Type number	Package		PNP complement
	Philips	JEITA	
BC817	SOT23	-	BC807
BC817W	SOT323	SC-70	BC807W
BC337 [1]	SOT54 (TO-92)	SC-43A	BC327

[1] Also available in SOT54A and SOT54 variant packages (see [Section 2](#)).

1.2 Features

- High current
- Low voltage

1.3 Applications

- General-purpose switching and amplification

1.4 Quick reference data

Table 2: Quick reference data

Symbol	Parameter	Conditions	Min	Typ	Max	Unit
V_{CE0}	collector-emitter voltage	open base; $I_C = 10 \text{ mA}$	-	-	45	V
I_C	collector current (DC)		-	-	500	mA
I_{CM}	peak collector current		-	-	1	A
h_{FE}	DC current gain	$I_C = 100 \text{ mA};$ $V_{CE} = 1 \text{ V}$	[1]	-	-	-
	BC817; BC817W; BC337			100	-	600
	BC817-16; BC817-16W; BC337-16			100	-	250
	BC817-25; BC817-25W; BC337-25			160	-	400
	BC817-40; BC817-40W; BC337-40			250	-	600

[1] Pulse test: $t_p \leq 300 \mu\text{s}; \delta \leq 0.02$.

PHILIPS

2. Pinning information

Table 3: Pinning

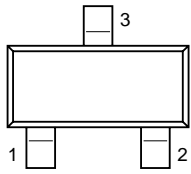
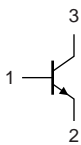
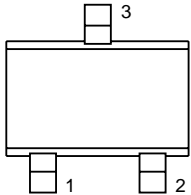
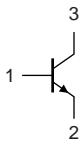
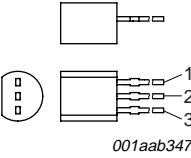
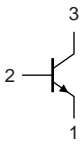
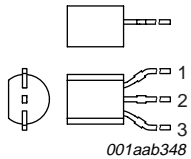
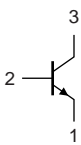
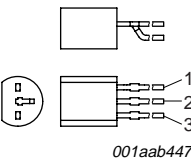
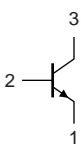
Pin	Description	Simplified outline	Symbol
SOT23			
1	base	 <p>SOT23</p>	 <p>sym021</p>
2	emitter		
3	collector		
SOT323			
1	base	 <p>sot323_so</p>	 <p>sym021</p>
2	emitter		
3	collector		
SOT54			
1	emitter	 <p>001aab347</p>	 <p>sym026</p>
2	base		
3	collector		
SOT54A			
1	emitter	 <p>001aab348</p>	 <p>sym026</p>
2	base		
3	collector		
SOT54 variant			
1	emitter	 <p>001aab447</p>	 <p>sym026</p>
2	base		
3	collector		

3. Ordering information

Table 4: Ordering information

Type number ^[1]	Package		
	Name	Description	Version
BC817	-	plastic surface mounted package; 3 leads	SOT23
BC817W	SC-70	plastic surface mounted package; 3 leads	SOT323
BC337 ^[2]	SC-43A	plastic single-ended leaded (through hole) package; 3 leads	SOT54

[1] Valid for all available selection groups.

[2] Also available in SOT54A and SOT54 variant packages (see [Section 2](#) and [Section 9](#)).

4. Marking

Table 5: Marking codes

Type number	Marking code ^[1]
BC817	6D*
BC817-16	6A*
BC817-25	6B*
BC817-40	6C*
BC817W	6D*
BC817-16W	6A*
BC817-25W	6B*
BC817-40W	6C*
BC337	C337
BC337-16	C33716
BC337-25	C33725
BC337-40	C33740

[1] * = -: made in Hong Kong
 * = p: made in Hong Kong
 * = t: made in Malaysia
 * = W: made in China

5. Limiting values

Table 6: Limiting values

In accordance with the Absolute Maximum Rating System (IEC 60134).

Symbol	Parameter	Conditions	Min	Max	Unit	
V_{CBO}	collector-base voltage	open emitter	-	50	V	
V_{CEO}	collector-emitter voltage	open base; $I_C = 10$ mA	-	45	V	
V_{EBO}	emitter-base voltage	open collector	-	5	V	
I_C	collector current (DC)		-	500	mA	
I_{CM}	peak collector current		-	1	A	
I_{BM}	peak base current		-	200	mA	
P_{tot}	total power dissipation					
	BC817	$T_{amb} \leq 25$ °C	[1][2]	-	250	mW
	BC817W	$T_{amb} \leq 25$ °C	[1][2]	-	200	mW
	BC337	$T_{amb} \leq 25$ °C	[1][2]	-	625	mW
T_{stg}	storage temperature		-65	+150	°C	
T_j	junction temperature		-	150	°C	
T_{amb}	ambient temperature		-65	+150	°C	

[1] Transistor mounted on an FR4 printed-circuit board, single-sided copper, tin-plated and standard footprint.

[2] Valid for all available selection groups.

6. Thermal characteristics

Table 7: Thermal characteristics

Symbol	Parameter	Conditions	Min	Typ	Max	Unit	
$R_{th(j-a)}$	thermal resistance from junction to ambient						
	BC817	$T_{amb} \leq 25$ °C	[1][2]	-	-	500	K/W
	BC817W	$T_{amb} \leq 25$ °C	[1][2]	-	-	625	K/W
	BC337	$T_{amb} \leq 25$ °C	[1][2]	-	-	200	K/W

[1] Transistor mounted on an FR4 printed-circuit board, single-sided copper, tin-plated and standard footprint.

[2] Valid for all available selection groups.

7. Characteristics

Table 8: Characteristics
 $T_{amb} = 25\text{ }^{\circ}\text{C}$ unless otherwise specified.

Symbol	Parameter	Conditions	Min	Typ	Max	Unit
I_{CBO}	collector-base cut-off current	$I_E = 0\text{ A}; V_{CB} = 20\text{ V}$	-	-	100	nA
		$I_E = 0\text{ A}; V_{CB} = 20\text{ V};$ $T_j = 150\text{ }^{\circ}\text{C}$	-	-	5	μA
I_{EBO}	emitter-base cut-off current	$I_C = 0\text{ A}; V_{EB} = 5\text{ V}$	-	-	100	nA
h_{FE}	DC current gain	$I_C = 100\text{ mA}; V_{CE} = 1\text{ V}$	[1]			
			BC817; BC817W; BC337	100	-	600
			BC817-16; BC817-16W; BC337-16	100	-	250
			BC817-25; BC817-25W; BC337-25	160	-	400
	BC817-40; BC817-40W; BC337-40	250	-	600		
h_{FE}	DC current gain	$I_C = 500\text{ mA}; V_{CE} = 1\text{ V}$	[1] 40	-	-	
V_{CEsat}	collector-emitter saturation voltage	$I_C = 500\text{ mA}; I_B = 50\text{ mA}$	[1] -	-	700	mV
V_{BE}	base-emitter voltage	$I_C = 500\text{ mA}; V_{CE} = 1\text{ V}$	[2] -	-	1.2	V
C_c	collector capacitance	$I_E = i_e = 0\text{ A}; V_{CB} = 10\text{ V};$ $f = 1\text{ MHz}$	-	3	-	pF
f_T	transition frequency	$I_C = 10\text{ mA}; V_{CE} = 5\text{ V};$ $f = 100\text{ MHz}$	100	-	-	MHz

[1] Pulse test: $t_p \leq 300\text{ }\mu\text{s}; \delta \leq 0.02$.

[2] V_{BE} decreases by approximately 2 mV/K with increasing temperature.

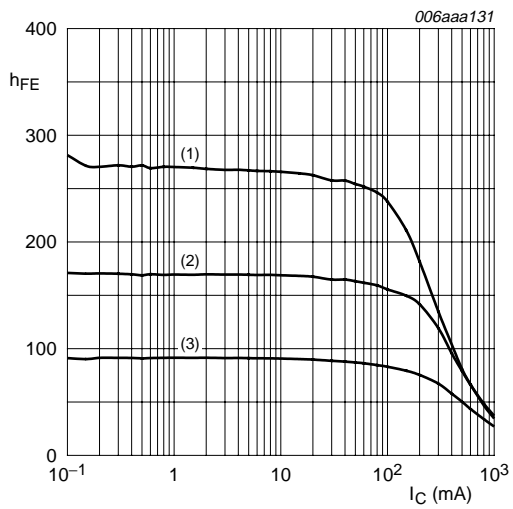

$V_{CE} = 1 \text{ V.}$
 (1) $T_{amb} = 150 \text{ °C.}$
 (2) $T_{amb} = 25 \text{ °C.}$
 (3) $T_{amb} = -55 \text{ °C.}$

Fig 1. Selection -16: DC current gain as a function of collector current; typical values.

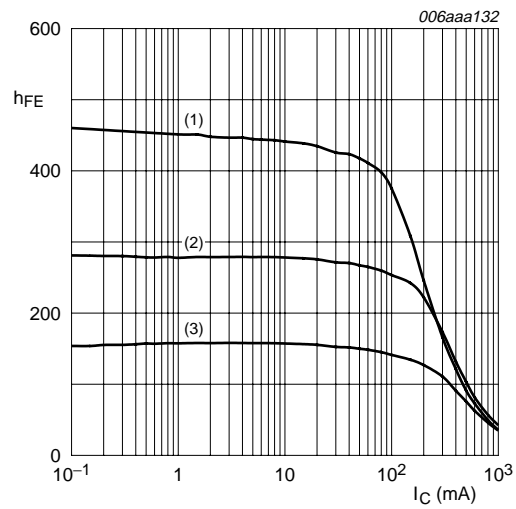

$V_{CE} = 1 \text{ V.}$
 (1) $T_{amb} = 150 \text{ °C.}$
 (2) $T_{amb} = 25 \text{ °C.}$
 (3) $T_{amb} = -55 \text{ °C.}$

Fig 2. Selection -25: DC current gain as a function of collector current; typical values.

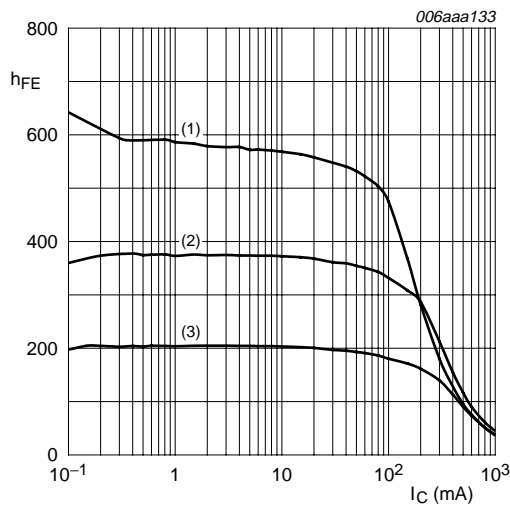

$V_{CE} = 1 \text{ V.}$
 (1) $T_{amb} = 150 \text{ °C.}$
 (2) $T_{amb} = 25 \text{ °C.}$
 (3) $T_{amb} = -55 \text{ °C.}$

Fig 3. Selection -40: DC current gain as a function of collector current; typical values.

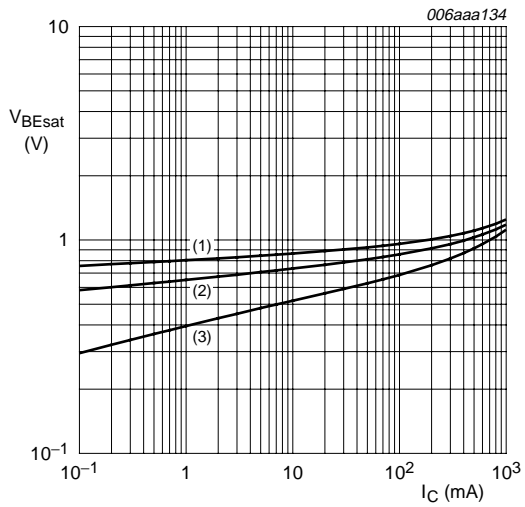

$I_C/I_B = 10$.

- (1) $T_{amb} = -55\text{ °C}$.
- (2) $T_{amb} = 25\text{ °C}$.
- (3) $T_{amb} = 150\text{ °C}$.

Fig 4. Selection -16: Base-emitter saturation voltage as a function of collector current; typical values.

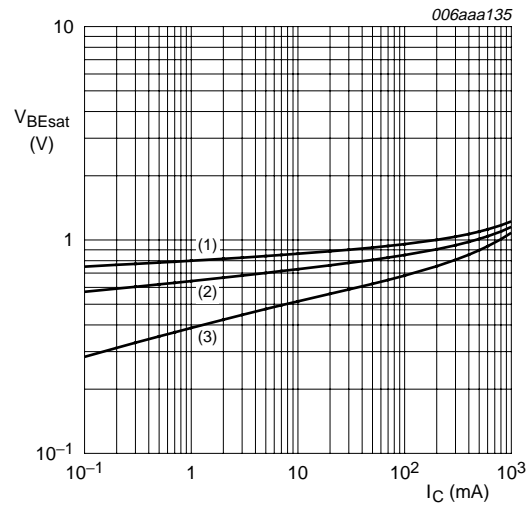

$I_C/I_B = 10$.

- (1) $T_{amb} = -55\text{ °C}$.
- (2) $T_{amb} = 25\text{ °C}$.
- (3) $T_{amb} = 150\text{ °C}$.

Fig 5. Selection -25: Base-emitter saturation voltage as a function of collector current; typical values.

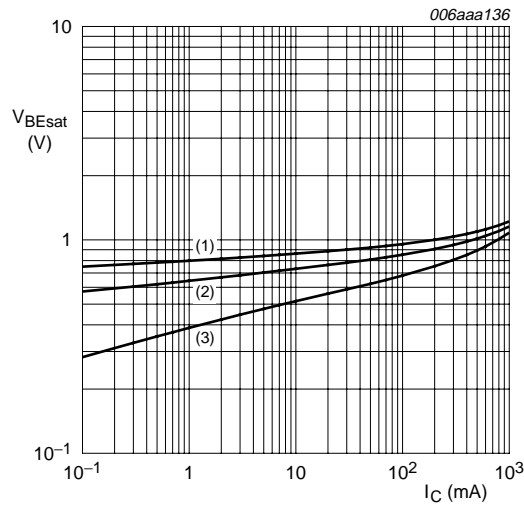

$I_C/I_B = 10$.

- (1) $T_{amb} = -55\text{ °C}$.
- (2) $T_{amb} = 25\text{ °C}$.
- (3) $T_{amb} = 150\text{ °C}$.

Fig 6. Selection -40: Base-emitter saturation voltage as a function of collector current; typical values.

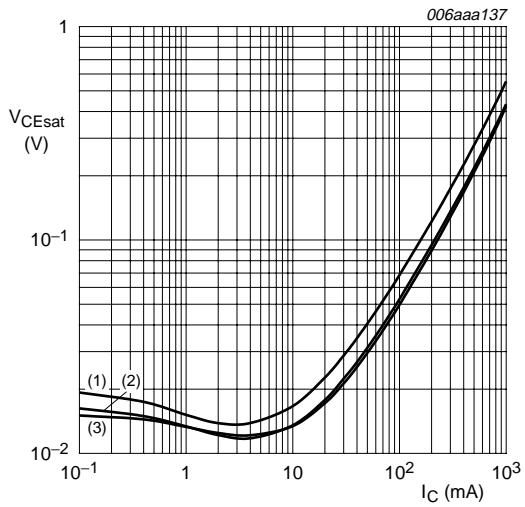

$I_C/I_B = 10$.

- (1) $T_{amb} = 150\text{ °C}$.
- (2) $T_{amb} = 25\text{ °C}$.
- (3) $T_{amb} = -55\text{ °C}$.

Fig 7. Selection -16: Collector-emitter saturation voltage as a function of collector current; typical values.

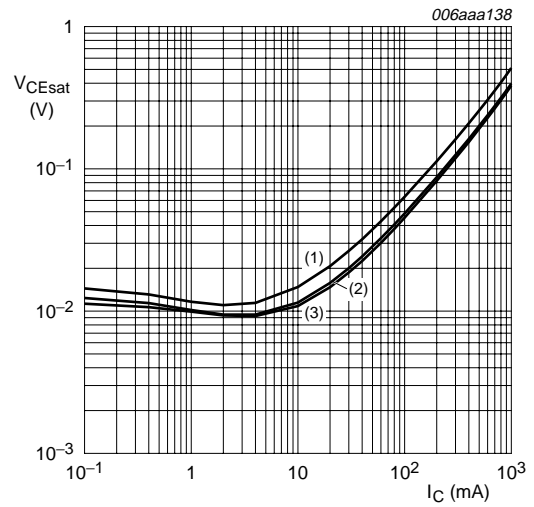

$I_C/I_B = 10$.

- (1) $T_{amb} = 150\text{ °C}$.
- (2) $T_{amb} = 25\text{ °C}$.
- (3) $T_{amb} = -55\text{ °C}$.

Fig 8. Selection -25: Collector-emitter saturation voltage as a function of collector current; typical values.

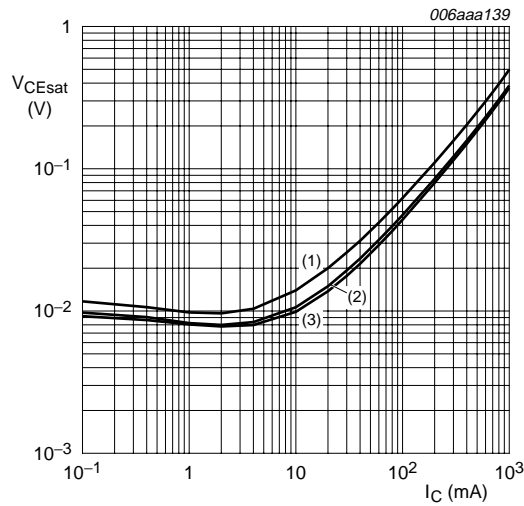

$I_C/I_B = 10$.

- (1) $T_{amb} = 150\text{ °C}$.
- (2) $T_{amb} = 25\text{ °C}$.
- (3) $T_{amb} = -55\text{ °C}$.

Fig 9. Selection -40: Collector-emitter saturation voltage as a function of collector current; typical values.

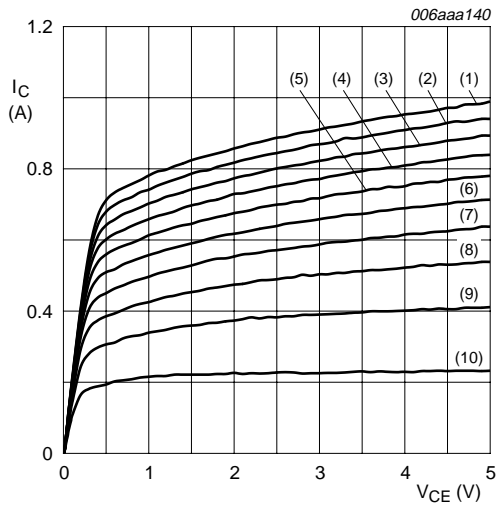

$T_{amb} = 25\text{ }^\circ\text{C}$.

- (1) $I_B = 16.0\text{ mA}$.
- (2) $I_B = 14.4\text{ mA}$.
- (3) $I_B = 12.8\text{ mA}$.
- (4) $I_B = 11.2\text{ mA}$.
- (5) $I_B = 9.6\text{ mA}$.
- (6) $I_B = 8.0\text{ mA}$.
- (7) $I_B = 6.4\text{ mA}$.
- (8) $I_B = 4.8\text{ mA}$.
- (9) $I_B = 3.2\text{ mA}$.
- (10) $I_B = 1.6\text{ mA}$.

Fig 10. Selection -16: Collector current as a function of collector-emitter voltage; typical values.

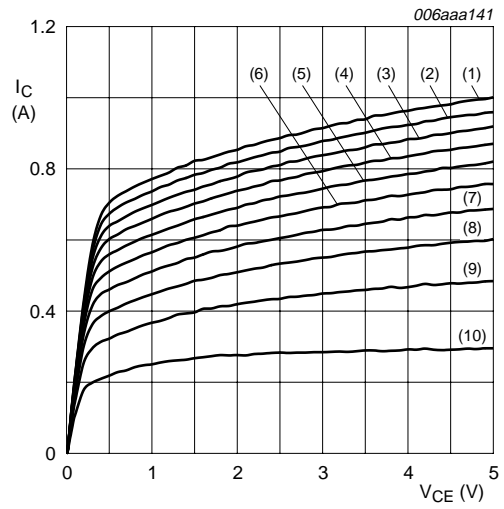

$T_{amb} = 25\text{ }^\circ\text{C}$.

- (1) $I_B = 13.0\text{ mA}$.
- (2) $I_B = 11.7\text{ mA}$.
- (3) $I_B = 10.4\text{ mA}$.
- (4) $I_B = 9.1\text{ mA}$.
- (5) $I_B = 7.8\text{ mA}$.
- (6) $I_B = 6.5\text{ mA}$.
- (7) $I_B = 5.2\text{ mA}$.
- (8) $I_B = 3.9\text{ mA}$.
- (9) $I_B = 2.6\text{ mA}$.
- (10) $I_B = 1.3\text{ mA}$.

Fig 11. Selection -25: Collector current as a function of collector-emitter voltage; typical values.

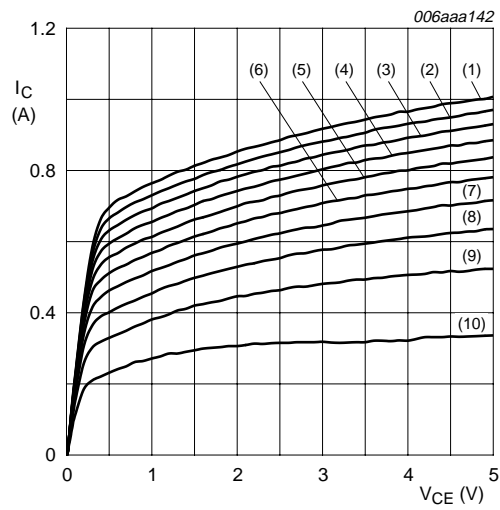

$T_{amb} = 25$ °C.

- (1) $I_B = 12.0$ mA.
- (2) $I_B = 10.8$ mA.
- (3) $I_B = 9.6$ mA.
- (4) $I_B = 8.4$ mA.
- (5) $I_B = 7.2$ mA.
- (6) $I_B = 6.0$ mA.
- (7) $I_B = 4.8$ mA.
- (8) $I_B = 3.6$ mA.
- (9) $I_B = 2.4$ mA.
- (10) $I_B = 1.2$ mA.

Fig 12. Selection -40: Collector current as a function of collector-emitter voltage; typical values.

8. Package outline

Plastic surface mounted package; 3 leads

SOT23

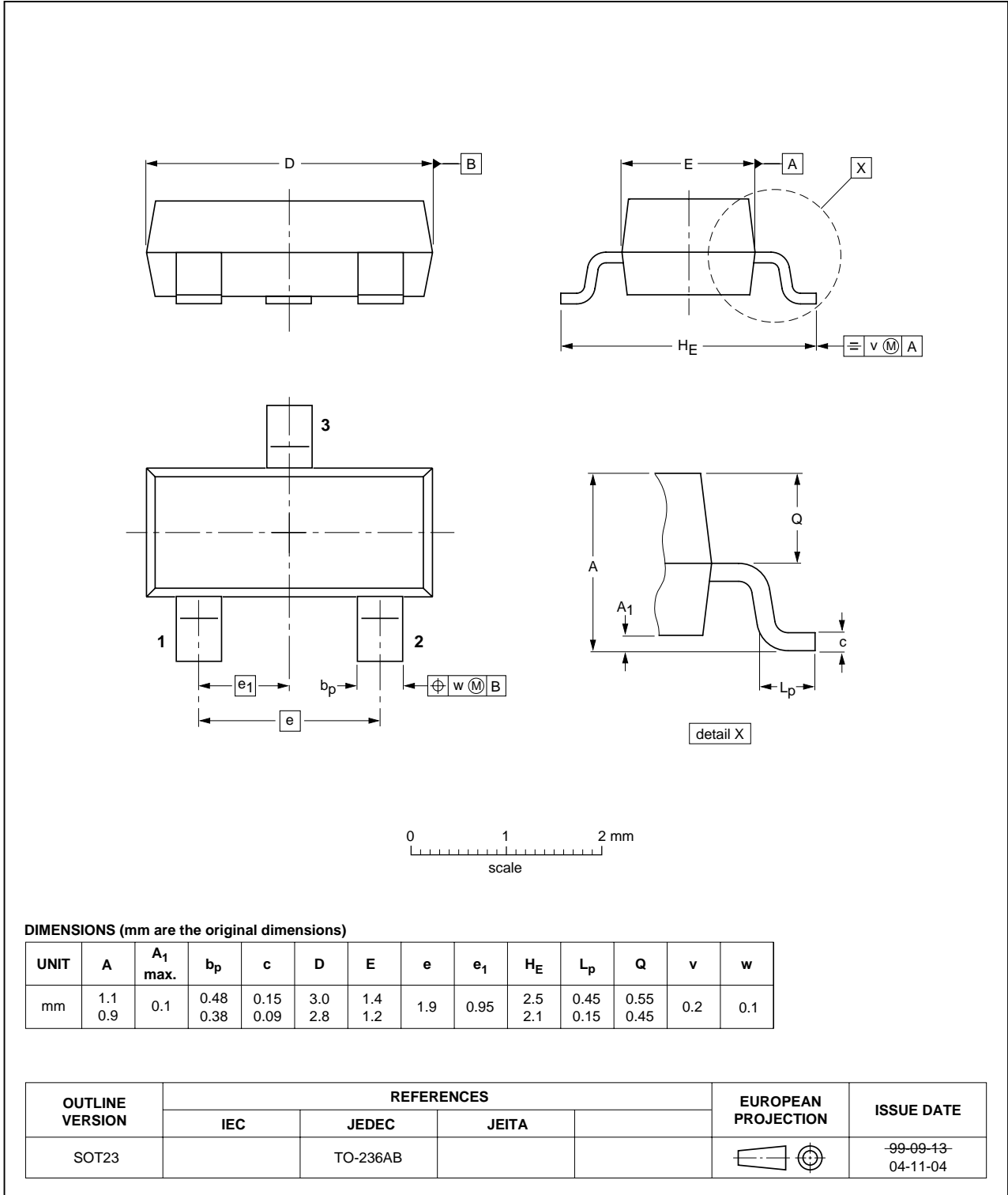

Fig 13. Package outline SOT23 (TO-236AB).

Plastic surface mounted package; 3 leads

SOT323

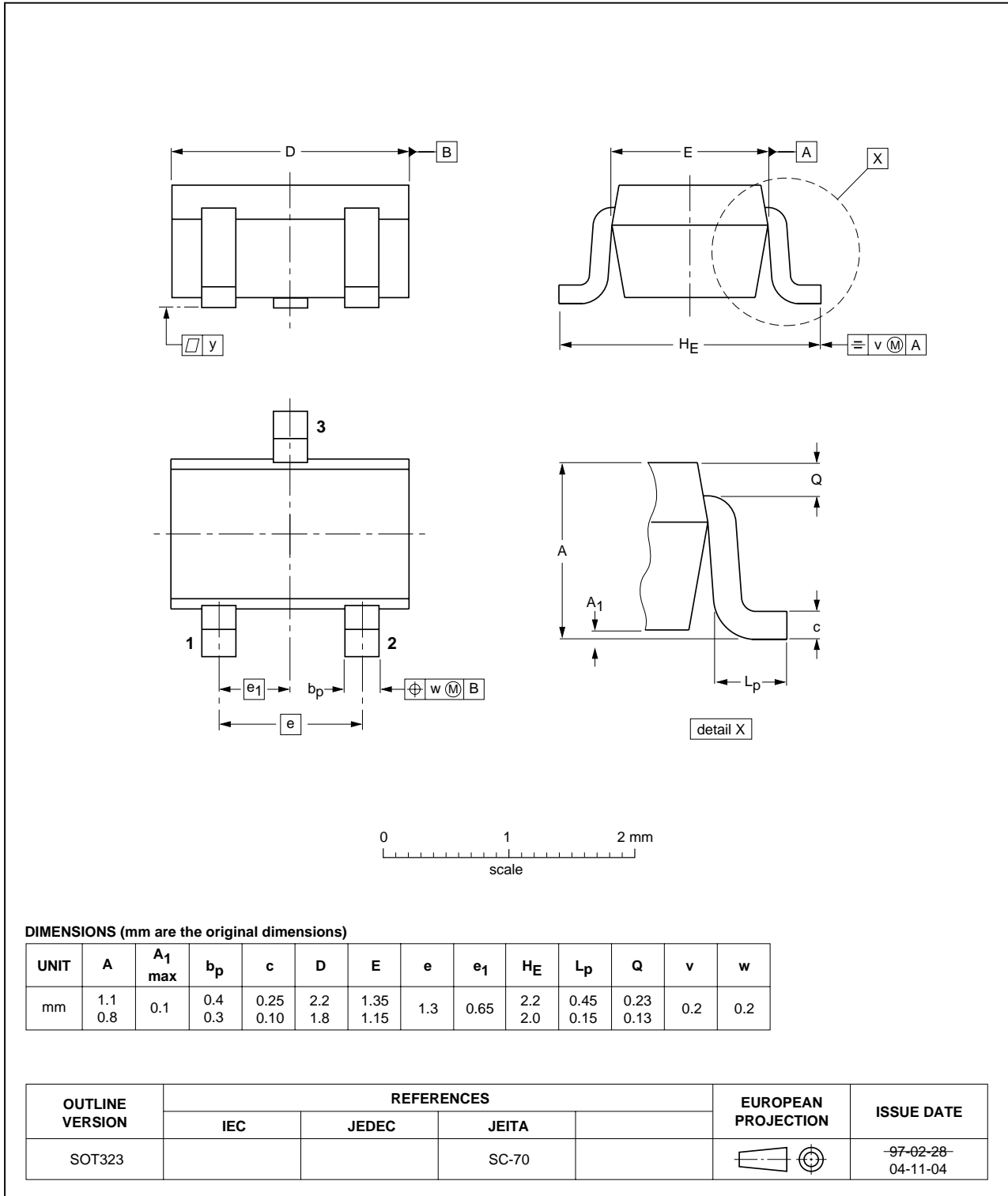

Fig 14. Package outline SOT323 (SC-70).

Plastic single-ended leaded (through hole) package; 3 leads

SOT54

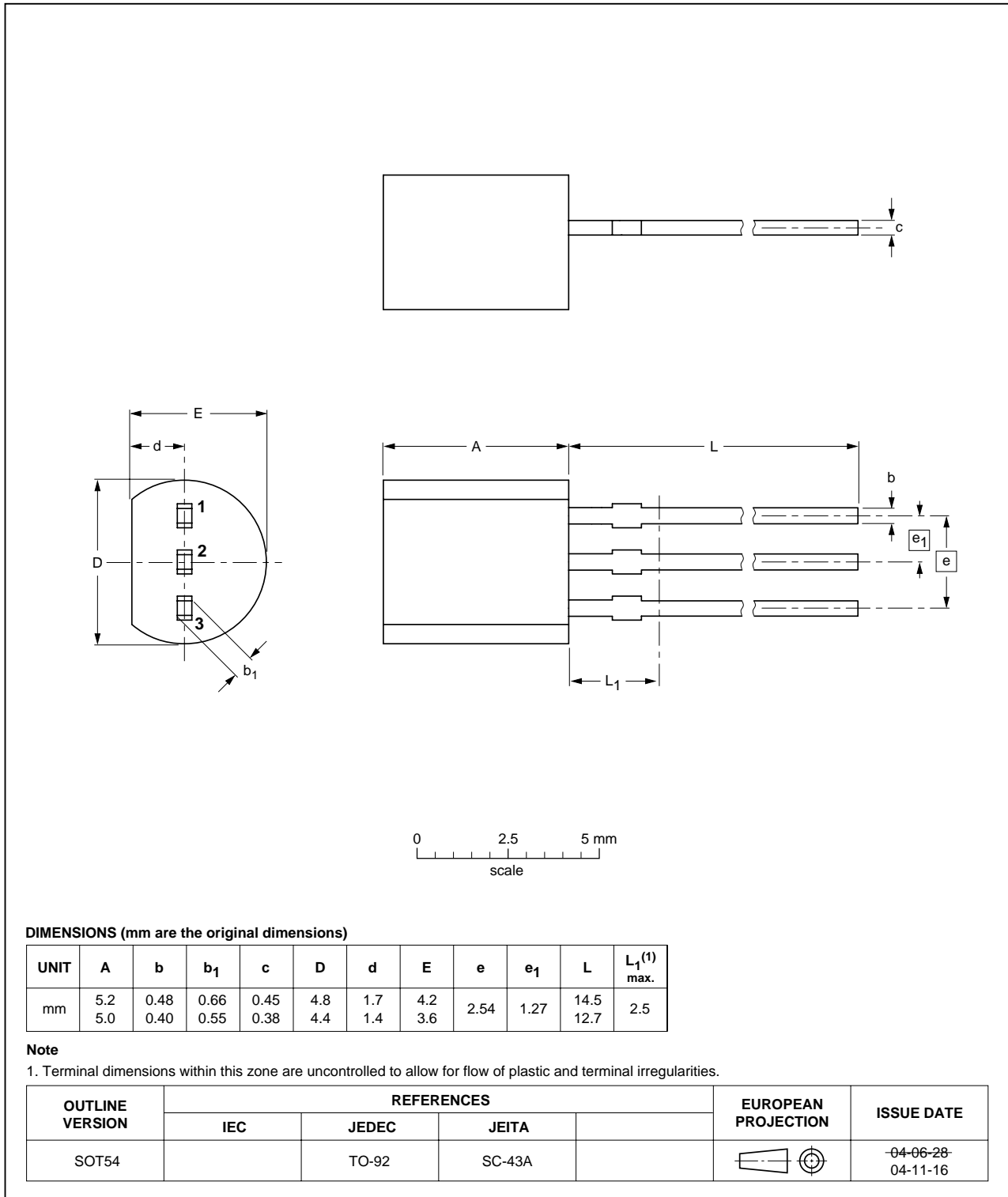

Fig 15. Package outline SOT54 (SC-43A/TO-92).

Plastic single-ended leaded (through hole) package; 3 leads (wide pitch) SOT54A

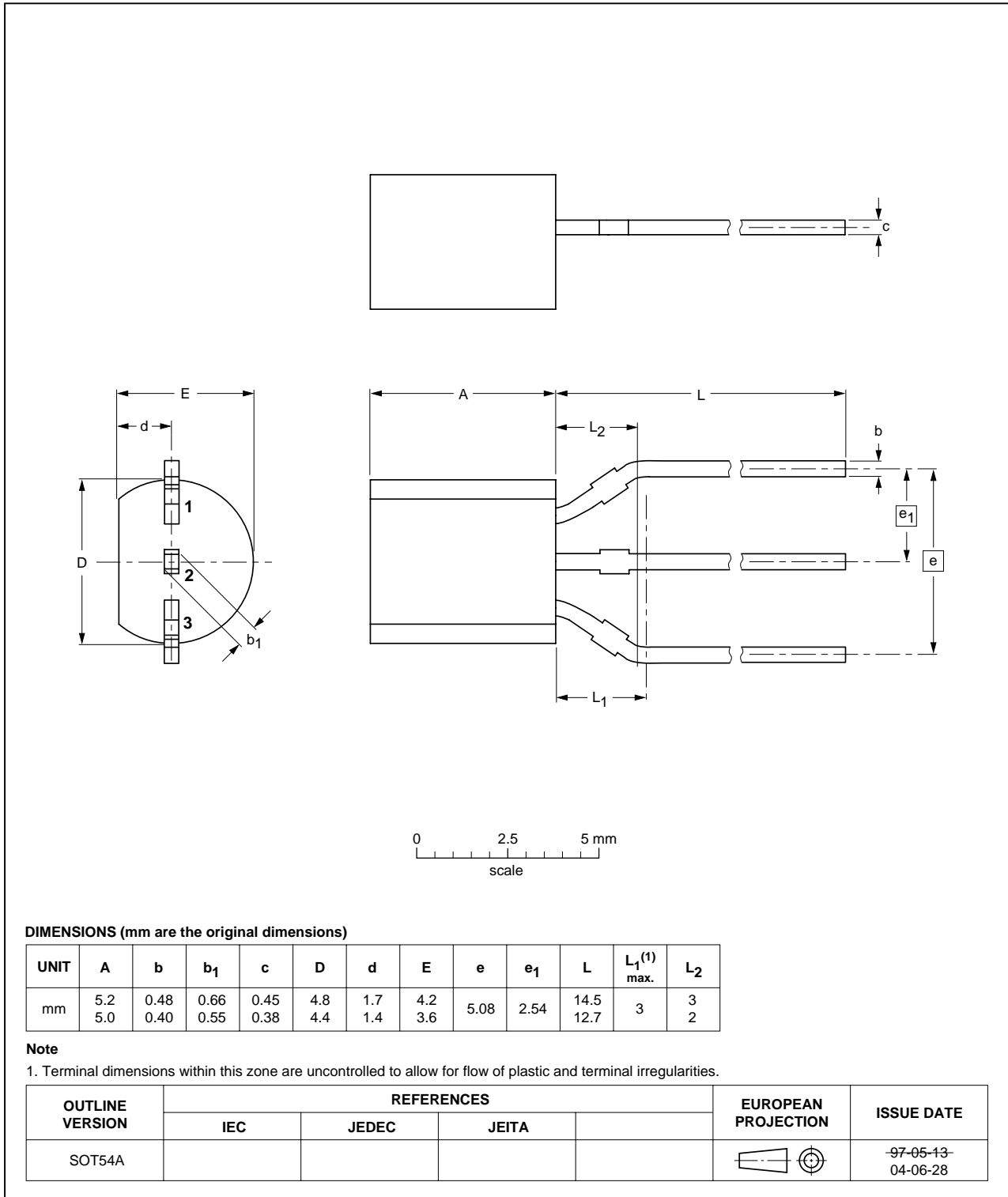

Fig 16. Package outline SOT54A.

Plastic single-ended leaded (through hole) package; 3 leads (on-circle)

SOT54 variant

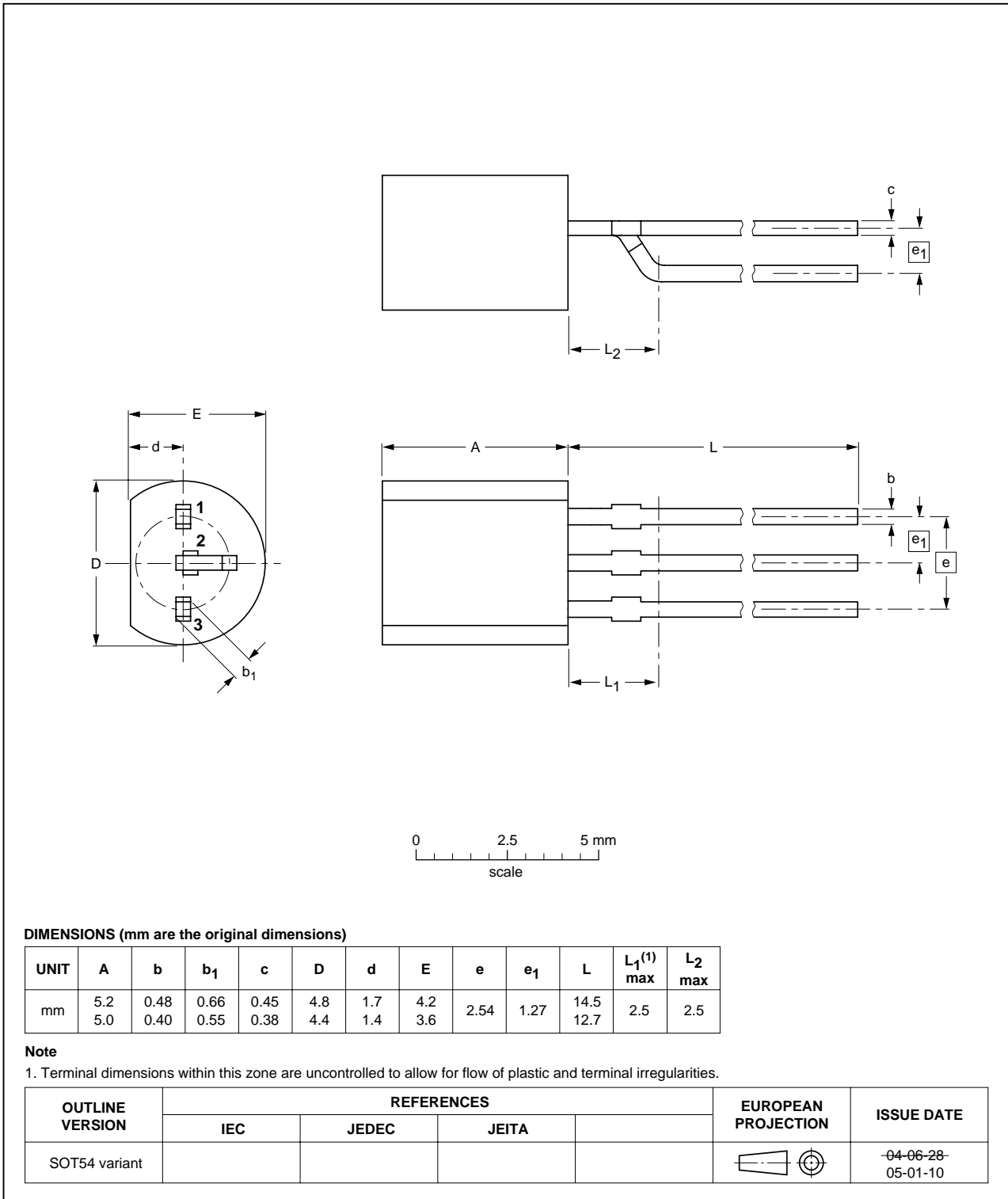

Fig 17. Package outline SOT54 variant.

9. Packing information

Table 9: Packing methods

The indicated -xxx are the last three digits of the 12NC ordering code. [\[1\]](#)

Type number	Package	Description	Packing quantity		
			3000	5000	10000
BC817	SOT23	4 mm pitch, 8 mm tape and reel	-215	-	-235
BC817W	SOT323	4 mm pitch, 8 mm tape and reel	-115	-	-135
BC337	SOT54	bulk, straight leads	-	-412	-
BC337	SOT54A	tape and reel, wide pitch	-	-	-116
BC337	SOT54A	tape ammopack, wide pitch	-	-	-126
BC337	SOT 54 variant	bulk, delta pinning (on-circle)	-	-112	-

[1] For further information and the availability of packing methods, see [Section 14](#).

10. Revision history

Table 10: Revision history

Document ID	Release date	Data sheet status	Change notice	Doc. number	Supersedes
BC817_BC817W_ BC337_5	20050121	Product data sheet	CPCN200302007F1	9397 750 14022	BC817_4; BC817W_SER_4; BC337_3
Modifications:					<ul style="list-style-type: none"> • The format of the data sheet has been redesigned to comply with the new presentation and information standard of Philips Semiconductors. • This data sheet is a combination of the previous data sheets BC817_4, BC817W_SER_4 and BC337_3. • Table 1 and 2 added • Table 3 Discrete pinning for SOT54A and SOT54 variant added • Table 5 Marking codes for BC337, BC337-16, BC337-25 and BC337-40 added • Table 8 Typical value for C_c changed to 3 pF according to CPCN200302007F1 • Figure 1, 2 and 3 amended • Figure 4, 5, 6, 7, 8, 9, 10, 11 and 12 added • Figure 15 changed according to CPCN200405006F • Figure 16 and 17 added • Section 9 added
BC817_4	20040105	Product specification	-	9397 750 12394	BC817_3
BC817W_SER_4	20040225	Product specification	-	9397 750 11944	BC817W_SER_3
BC337_3	19990415	Product specification	-	9397 750 05676	BC337_338_CNV_2

11. Data sheet status

Level	Data sheet status ^[1]	Product status ^[2] ^[3]	Definition
I	Objective data	Development	This data sheet contains data from the objective specification for product development. Philips Semiconductors reserves the right to change the specification in any manner without notice.
II	Preliminary data	Qualification	This data sheet contains data from the preliminary specification. Supplementary data will be published at a later date. Philips Semiconductors reserves the right to change the specification without notice, in order to improve the design and supply the best possible product.
III	Product data	Production	This data sheet contains data from the product specification. Philips Semiconductors reserves the right to make changes at any time in order to improve the design, manufacturing and supply. Relevant changes will be communicated via a Customer Product/Process Change Notification (CPCN).

[1] Please consult the most recently issued data sheet before initiating or completing a design.

[2] The product status of the device(s) described in this data sheet may have changed since this data sheet was published. The latest information is available on the Internet at URL <http://www.semiconductors.philips.com>.

[3] For data sheets describing multiple type numbers, the highest-level product status determines the data sheet status.

12. Definitions

Short-form specification — The data in a short-form specification is extracted from a full data sheet with the same type number and title. For detailed information see the relevant data sheet or data handbook.

Limiting values definition — Limiting values given are in accordance with the Absolute Maximum Rating System (IEC 60134). Stress above one or more of the limiting values may cause permanent damage to the device. These are stress ratings only and operation of the device at these or at any other conditions above those given in the Characteristics sections of the specification is not implied. Exposure to limiting values for extended periods may affect device reliability.

Application information — Applications that are described herein for any of these products are for illustrative purposes only. Philips Semiconductors make no representation or warranty that such applications will be suitable for the specified use without further testing or modification.

13. Disclaimers

Life support — These products are not designed for use in life support appliances, devices, or systems where malfunction of these products can reasonably be expected to result in personal injury. Philips Semiconductors customers using or selling these products for use in such applications do so at their own risk and agree to fully indemnify Philips Semiconductors for any damages resulting from such application.

Right to make changes — Philips Semiconductors reserves the right to make changes in the products - including circuits, standard cells, and/or software - described or contained herein in order to improve design and/or performance. When the product is in full production (status 'Production'), relevant changes will be communicated via a Customer Product/Process Change Notification (CPCN). Philips Semiconductors assumes no responsibility or liability for the use of any of these products, conveys no license or title under any patent, copyright, or mask work right to these products, and makes no representations or warranties that these products are free from patent, copyright, or mask work right infringement, unless otherwise specified.

14. Contact information

For additional information, please visit: <http://www.semiconductors.philips.com>

For sales office addresses, send an email to: sales.addresses@www.semiconductors.philips.com

15. Contents

1	Product profile	1
1.1	General description	1
1.2	Features	1
1.3	Applications	1
1.4	Quick reference data	1
2	Pinning information	2
3	Ordering information	3
4	Marking	3
5	Limiting values	4
6	Thermal characteristics	4
7	Characteristics	5
8	Package outline	11
9	Packing information	16
10	Revision history	17
11	Data sheet status	18
12	Definitions	18
13	Disclaimers	18
14	Contact information	18



© Koninklijke Philips Electronics N.V. 2005

All rights are reserved. Reproduction in whole or in part is prohibited without the prior written consent of the copyright owner. The information presented in this document does not form part of any quotation or contract, is believed to be accurate and reliable and may be changed without notice. No liability will be accepted by the publisher for any consequence of its use. Publication thereof does not convey nor imply any license under patent- or other industrial or intellectual property rights.

Date of release: 21 January 2005
Document number: 9397 750 14022

Published in The Netherlands