

ANT-2.4-MMG1-SMA Series Magnetic Mount 2.4 GHz Antennas

The ANT-2.4-MMG1-SMA antenna is an external panel mount multiband antenna designed for WiFi/WLAN and 2.4 GHz ISM band applications such as Bluetooth® and ZigBee®.

The ANT-2.4-MMG1-SMA series antennas provide a ground plane independent dipole antenna solution which mounts to ferrous metallic surfaces using the integrated magnetic base.

The antenna terminates in an SMA plug (male pin) connector on a 1 meter, 2 meter or 3 meter length of RG-174/U coaxial cable.



Features

- Performance at 2.4 GHz to 2.5 GHz
 - VSWR: ≤ 1.8
 - Peak Gain: 0.7 dBi
 - Efficiency: 40%
- Ground plane independent dipole antenna
- Compact, only 82.8 mm (3.26 in) tall
- Integrated magnetic base securely attaches to ferrous metallic surfaces and allows for repositioning
- SMA plug (male pin) connection

Applications

- Single-band WiFi/WLAN/802.11
 - WiFi 4
- 2.4 GHz ISM applications
 - Bluetooth®
 - ZigBee®
- U-NII and ISM applications
- Internet of Things (IoT) devices
- Smart Home networking
- Sensing and remote monitoring

Ordering Information

Part Number	Description
ANT-2.4-MMG1-SMA-1	Magnetic mount 2.4 GHz antenna with an SMA plug (male pin) connector on 1 m (39.37 in) RG-174/U coaxial cable
ANT-2.4-MMG1-SMA-2	Magnetic mount 2.4 GHz antenna with an SMA plug (male pin) connector on 2 m (78.74 in) RG-174/U coaxial cable
ANT-2.4-MMG1-SMA-3	Magnetic mount 2.4 GHz antenna with an SMA plug (male pin) connector on 3 m (118.11 in) RG-174/U coaxial cable

Available from Linx Technologies and select distributors and representatives.

Table 1. Electrical Specifications

ANT-2.4-MMG1	2.4 GHz		
Frequency Range	2.4 GHz to 2.5 GHz		
VSWR (max)	1.8		
Peak Gain (dBi)	0.7		
Average Gain (dBi)	-4.2		
Efficiency (%)	40		
Polarization	Linear	Radiation	Omnidirectional
Impedance	50 Ω	Max Power	10 W
Wavelength	1/2-wave	Electrical Type	Dipole

Electrical specifications and plots measured on a 300 mm x 300 mm (11.8 in x 11.8 in) ground plane.

Table 2. Mechanical Specifications

Part Number	Connection	Coaxial Cable, minimum inside bend radius	Weight
ANT-2.4-MMG1-SMA-1	SMA plug (male pin)	RG-174/U: 10.2 mm (0.40 in),	1 meter = 30.1 g (1.06 oz)
ANT-2.4-MMG1-SMA-2	SMA plug (male pin)	RG-174/U: 10.2 mm (0.40 in),	2 meters = 43.4 g (1.53 oz)
ANT-2.4-MMG1-SMA-3	SMA plug (male pin)	RG-174/U: 10.2 mm (0.40 in),	3 meters = 56.8 g (2.00 oz)
Operating Temp. Range	-20 °C to +80 °C		
Storage Temp. Range	-20 °C to +80 °C		
Dimensions	82.8 mm x Ø30.0 mm (3.26 in x Ø1.18 in)		

Product Dimensions

Figure 1 provides dimensions of the ANT-2.4-MMG1-SMA series antenna.

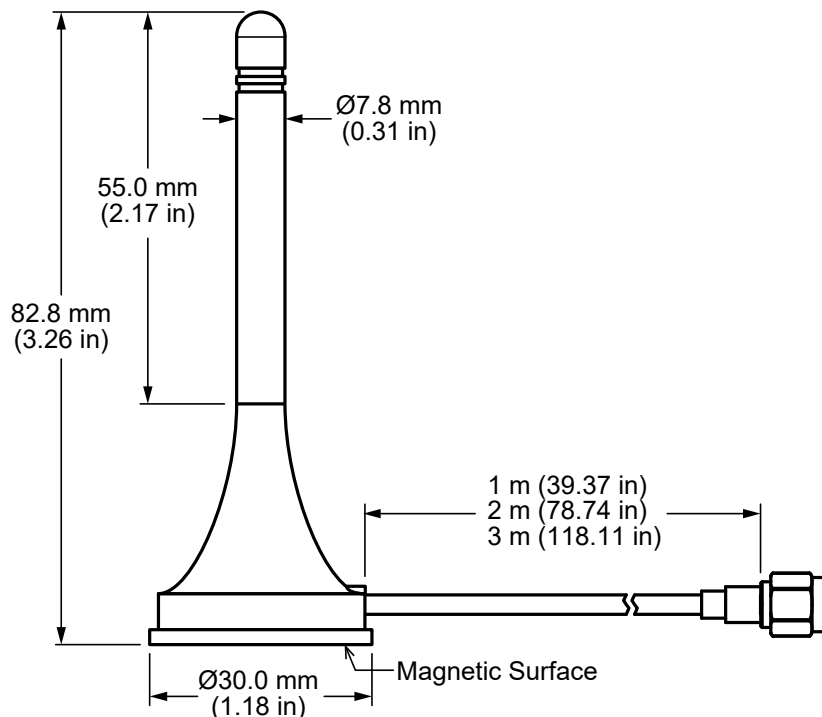

Figure 1. ANT-2.4-MMG1-SMA Series Antenna Dimensions

Antenna Mounting

The ANT-2.4-MMG1-SMA series antenna has an integrated magnetic base which mounts securely to ferrous metallic surfaces. The antenna should be mounted in a location that is not obstructed by other metallic surfaces which could interfere with signal transmission and reception. The magnetic base allows for the antenna to be repositioned as needed.

Packaging Information

The ANT-2.4-MMG1-SMA series antenna is individually sealed in a polyethylene bag 3.9 in x 7.1 in (100 mm x 180 mm) and packaged in larger bags in of 50 pcs 14.2 in x 20.5 in (360 mm x 520 mm). Bags are packed in cartons in quantities of 400 pcs. Distribution channels may offer alternative packaging options.

Antenna Orientation

The ANT-2.4-MMG1-SMA antenna is characterized in two antenna orientations as shown in Figure 2. The antenna free space orientation characterizes use of an antenna attached to an enclosure-mounted connector which is connected by cable to a printed circuit board. Although the antenna is a dipole not requiring a ground plane for function, characterization on an adjacent ground plane (300 mm x 300 mm) provides insight into antenna performance when attached directly to a connector on a metal enclosure. The two orientations represent the most common end-product use cases.



Figure 2. ANT-5GW-MMG1-SMA Test Orientations

On Ground Plane

The charts on the following pages represent data taken with the antenna oriented at the center of the 300 mm x 300 mm ground plane as shown in Figure 3.

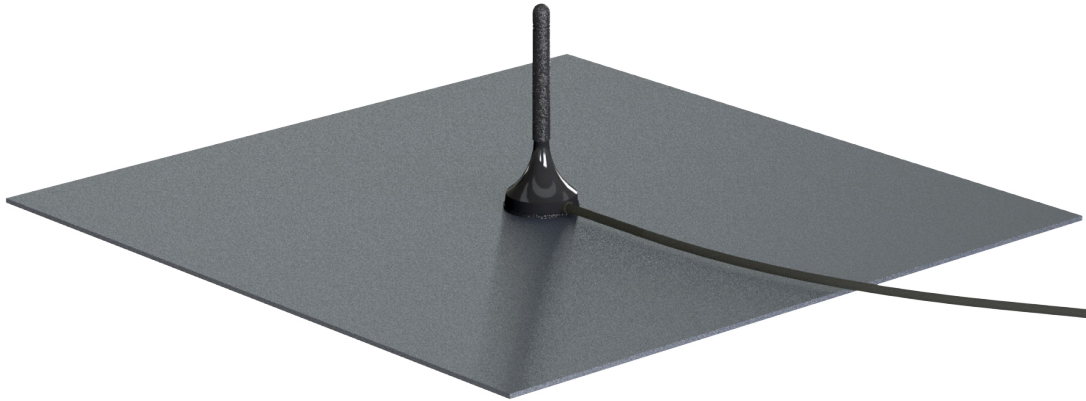

Figure 3. ANT-2.4-MMG1-SMA on Ground Plane

VSWR

Figure 4 provides the voltage standing wave ratio (VSWR) across the antenna bandwidth. VSWR describes the power reflected from the antenna back to the radio. A lower VSWR value indicates better antenna performance at a given frequency. Reflected power is also shown on the right-side vertical axis as a gauge of the percentage of transmitter power reflected back from the antenna.

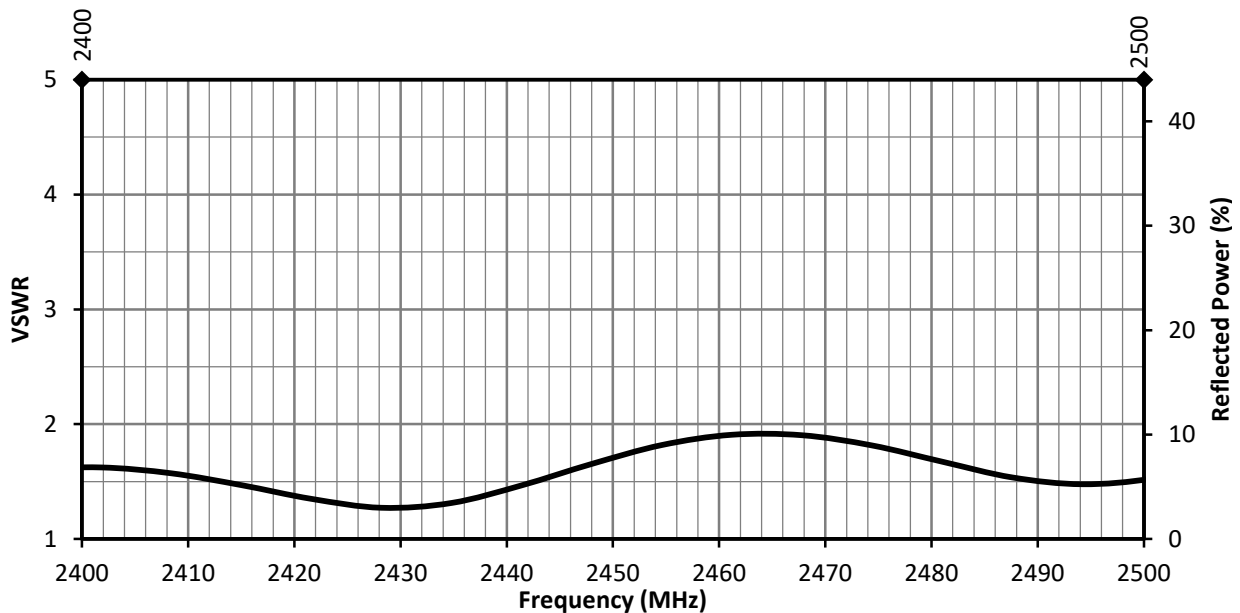

Figure 4. ANT-2.4-MMG1-SMA Antenna VSWR on Ground Plane

Return Loss

Return loss (Figure 5), represents the loss in power at the antenna due to reflected signals. Like VSWR, a lower return loss value indicates better antenna performance at a given frequency.

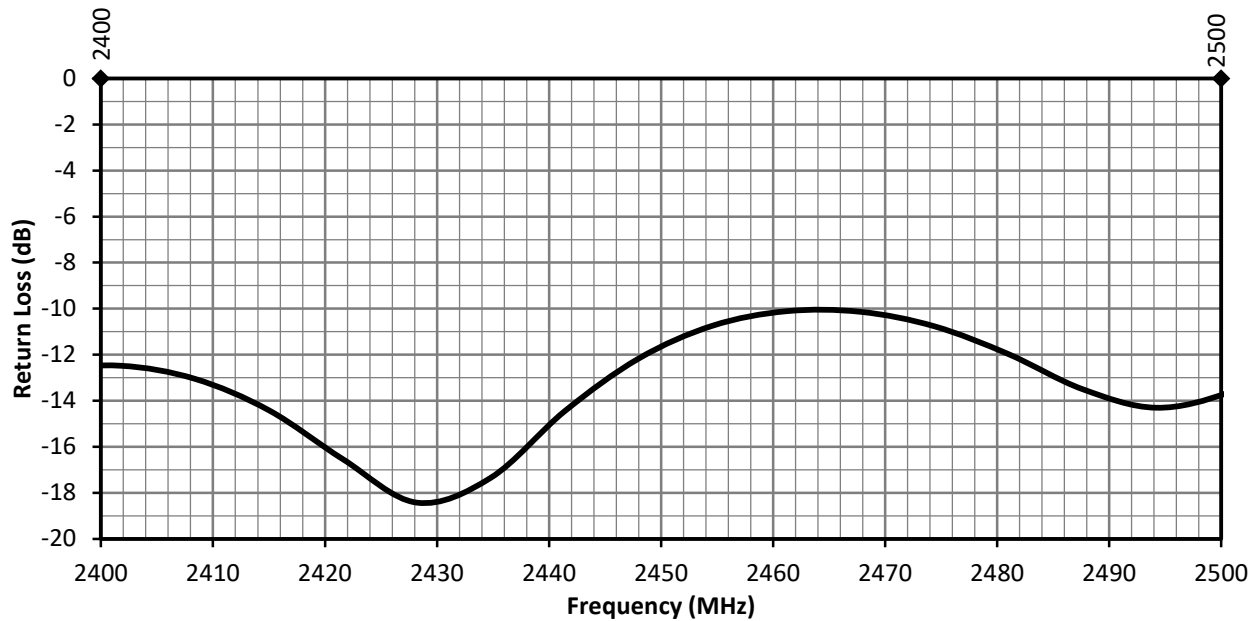

Figure 5. ANT-2.4-MMG1-SMA Antenna Return Loss on Ground Plane

Peak Gain

The peak gain across the antenna bandwidth is shown in Figure 6. Peak gain represents the maximum antenna input power concentration across 3-dimensional space, and therefore peak performance, at a given frequency, but does not consider any directionality in the gain pattern.

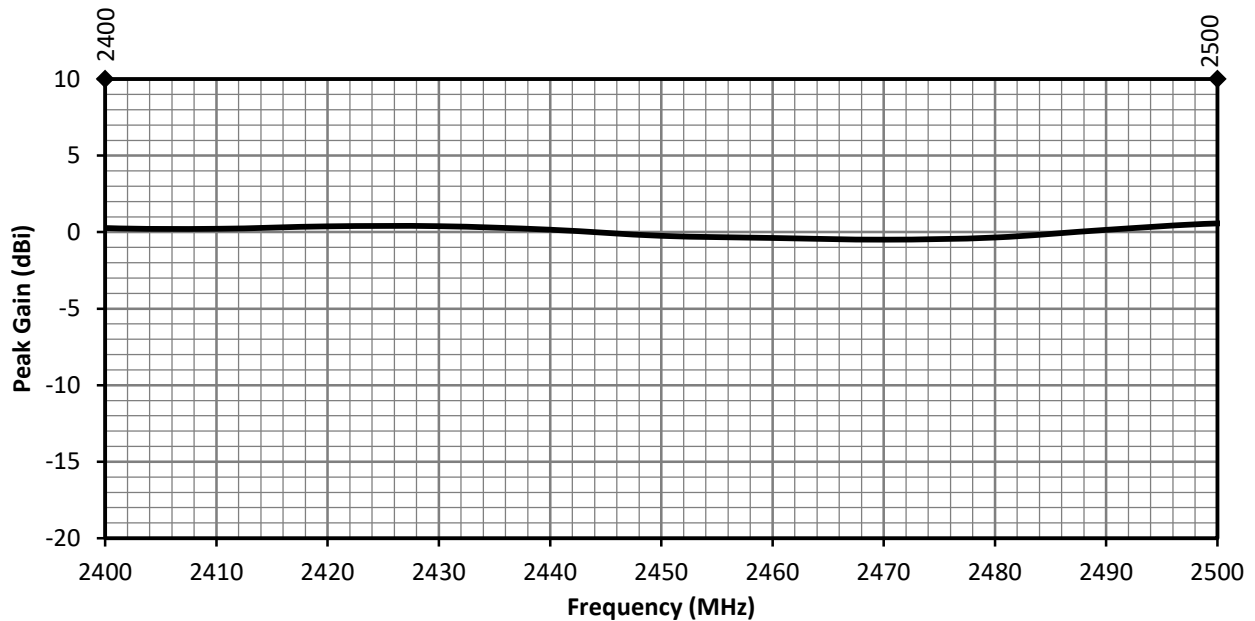

Figure 6. ANT-2.4-MMG1-SMA Antenna Peak Gain at Center of Ground Plane

Average Gain

Average gain (Figure 7), is the average of all antenna gain in 3-dimensional space at each frequency, providing an indication of overall performance without expressing antenna directionality.

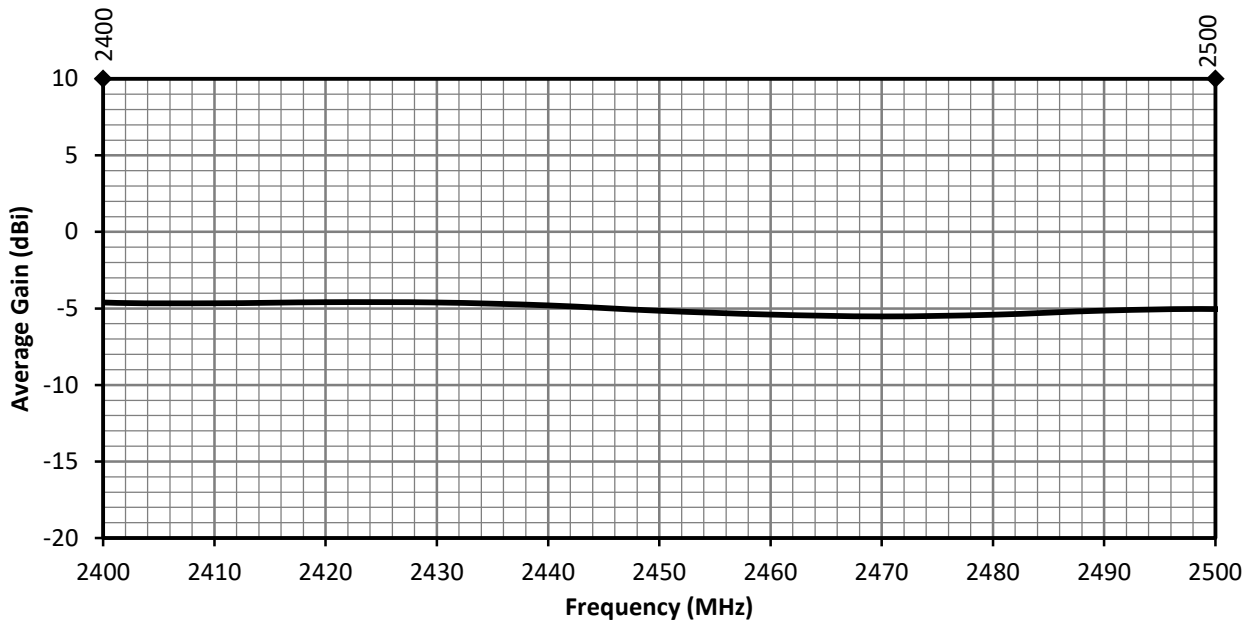

Figure 7. ANT-2.4-MMG1-SMA Antenna Average Gain on Ground Plane

Radiation Efficiency

Radiation efficiency (Figure 8), shows the ratio of power delivered to the antenna relative to the power radiated at the antenna, expressed as a percentage, where a higher percentage indicates better performance at a given frequency.

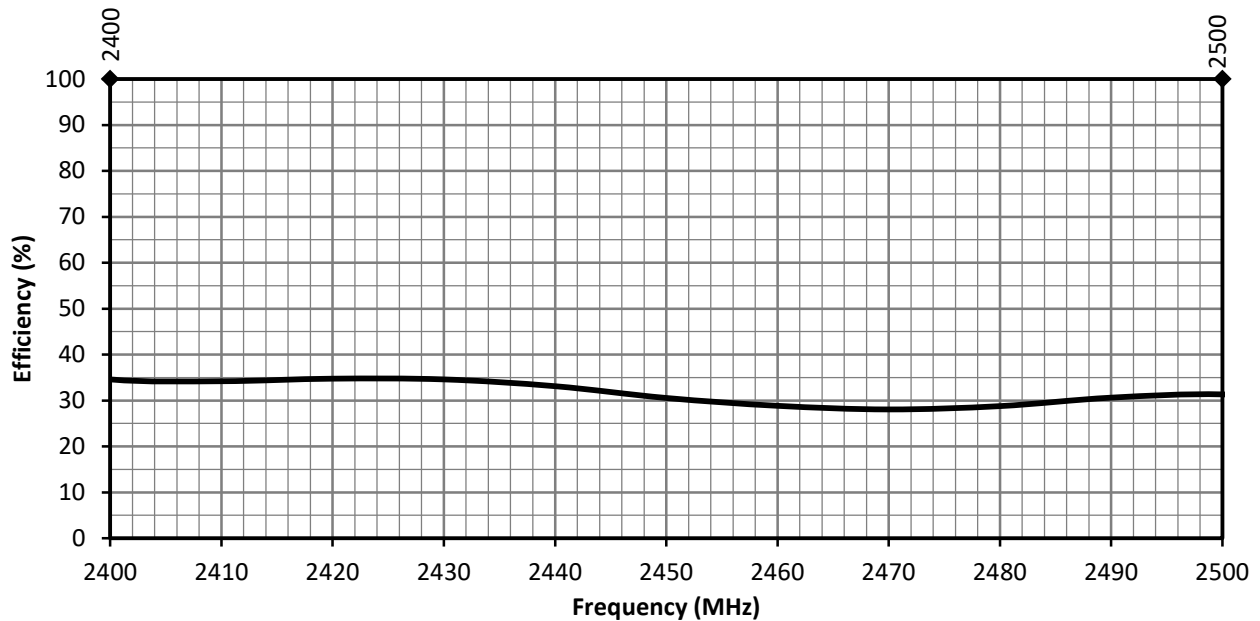

Figure 8. ANT-2.4-MMG1-SMA Antenna Radiation Efficiency on Ground Plane

Radiation Patterns

Radiation patterns provide information about the directionality and 3-dimensional gain performance of the antenna by plotting gain at specific frequencies in three orthogonal planes. Antenna radiation patterns (Figure 9), are shown using polar plots covering 360 degrees. The antenna graphic above the plots provides reference to the plane of the column of plots below it. Note: when viewed with typical PDF viewing software, zooming into radiation patterns is possible to reveal fine detail.

Radiation Patterns - On Ground Plane



2400 MHz to 2500 MHz (2450 MHz)

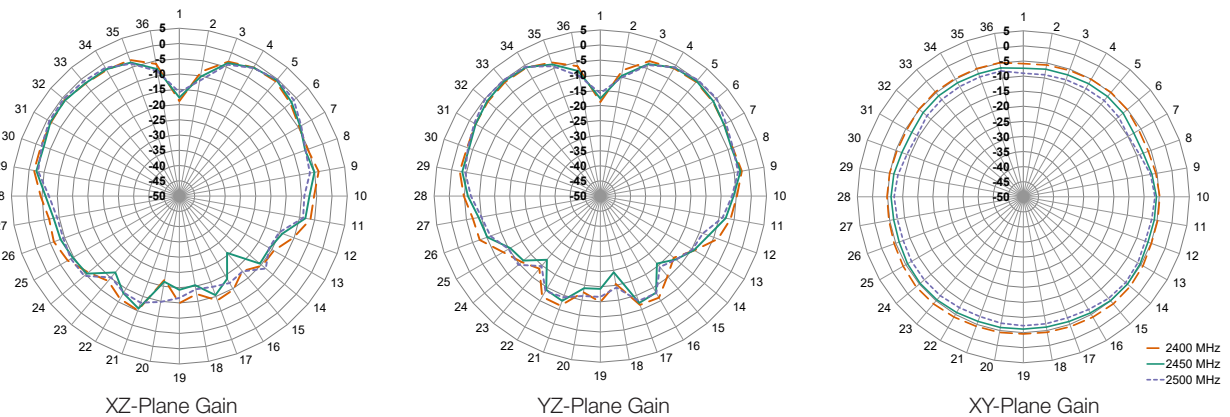

Figure 9. Radiation Patterns for ANT-2.4-MMG1-SMA Antenna on Ground Plane

Free Space, No Ground Plane

The charts on the following pages represent data taken with the antenna oriented in free space as shown in Figure 10.



Figure 10. ANT-5GW-MMG1-SMA No Ground Plane (Free Space)

VSWR

Figure 11 provides the voltage standing wave ratio (VSWR) across the antenna bandwidth. VSWR describes the power reflected from the antenna back to the radio. A lower VSWR value indicates better antenna performance at a given frequency. Reflected power is also shown on the right-side vertical axis as a gauge of the percentage of transmitter power reflected back from the antenna.

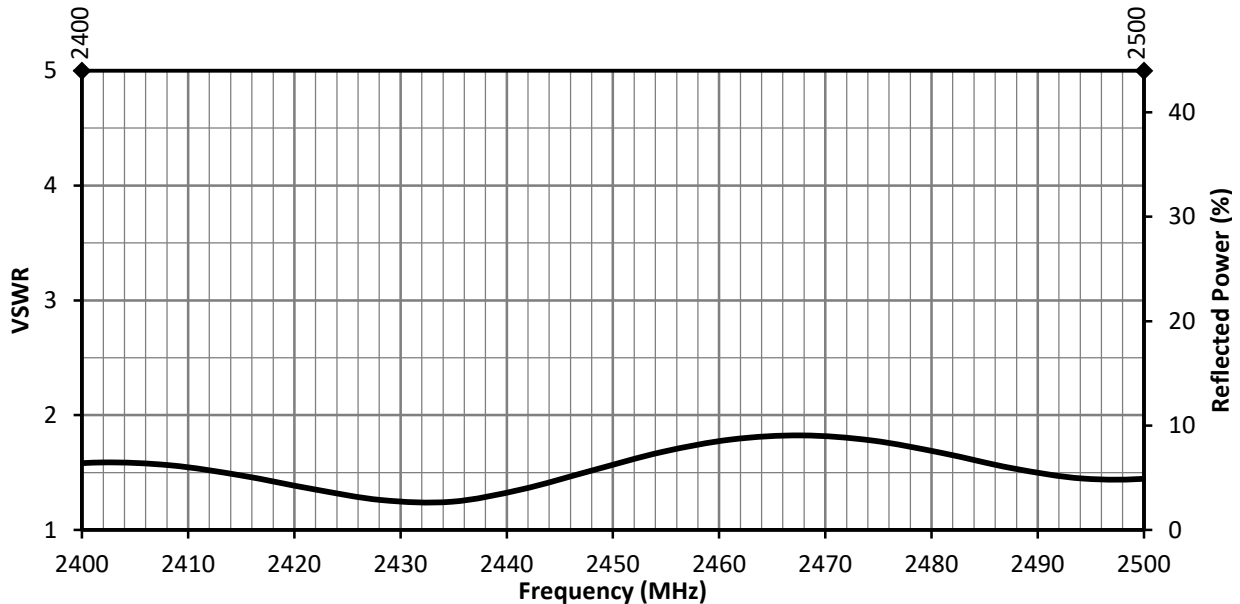

Figure 11. ANT-2.4-MMG1-SMA Antenna VSWR, Free Space

Return Loss

Return loss (Figure 12), represents the loss in power at the antenna due to reflected signals. Like VSWR, a lower return loss value indicates better antenna performance at a given frequency.

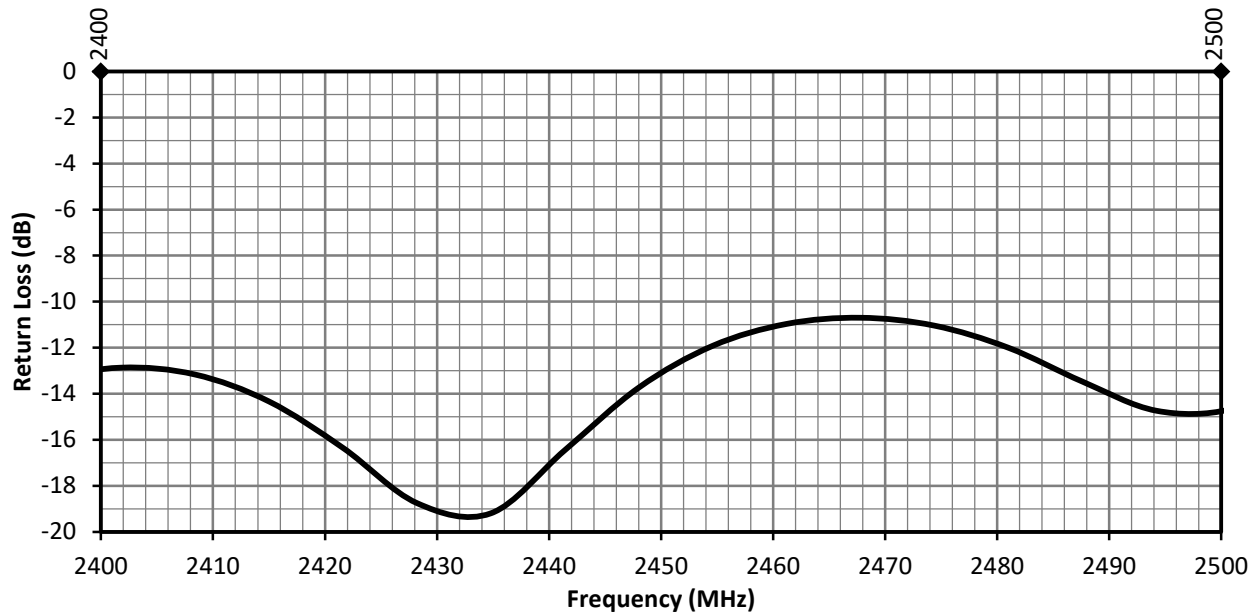

Figure 12. ANT-2.4-MMG1-SMA Antenna Return Loss, Free Space

Peak Gain

The peak gain across the antenna bandwidth is shown in Figure 13. Peak gain represents the maximum antenna input power concentration across 3-dimensional space, and therefore peak performance, at a given frequency, but does not consider any directionality in the gain pattern.

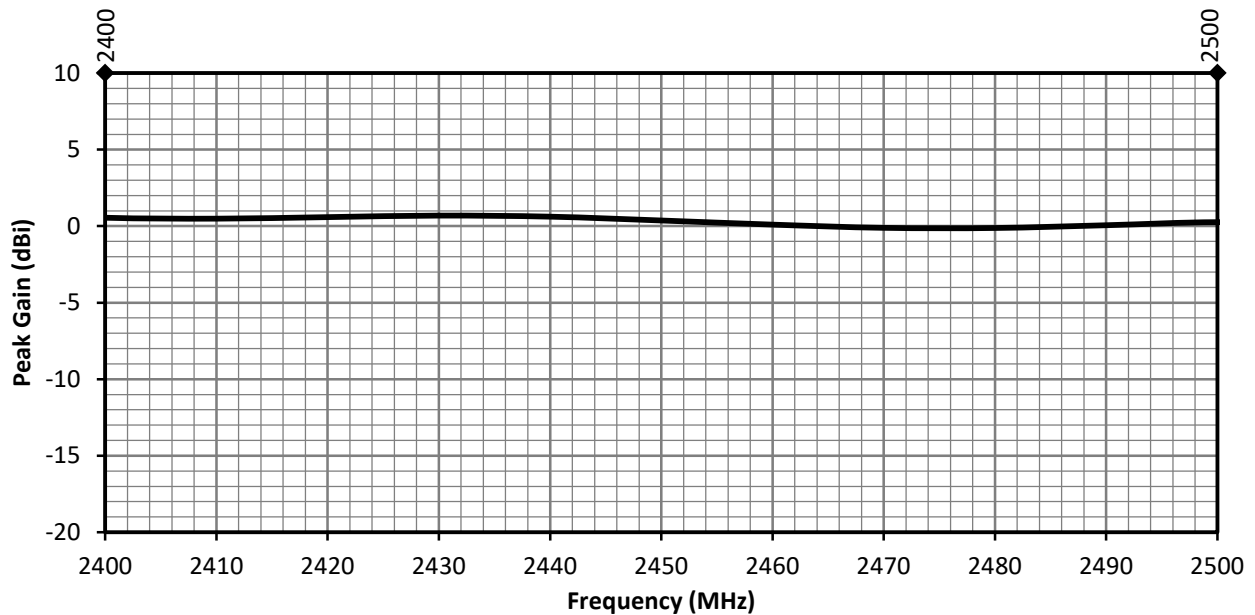

Figure 13. ANT-2.4-MMG1-SMA Antenna Peak Gain, Free Space

Average Gain

Average gain (Figure 14), is the average of all antenna gain in 3-dimensional space at each frequency, providing an indication of overall performance without expressing antenna directionality.

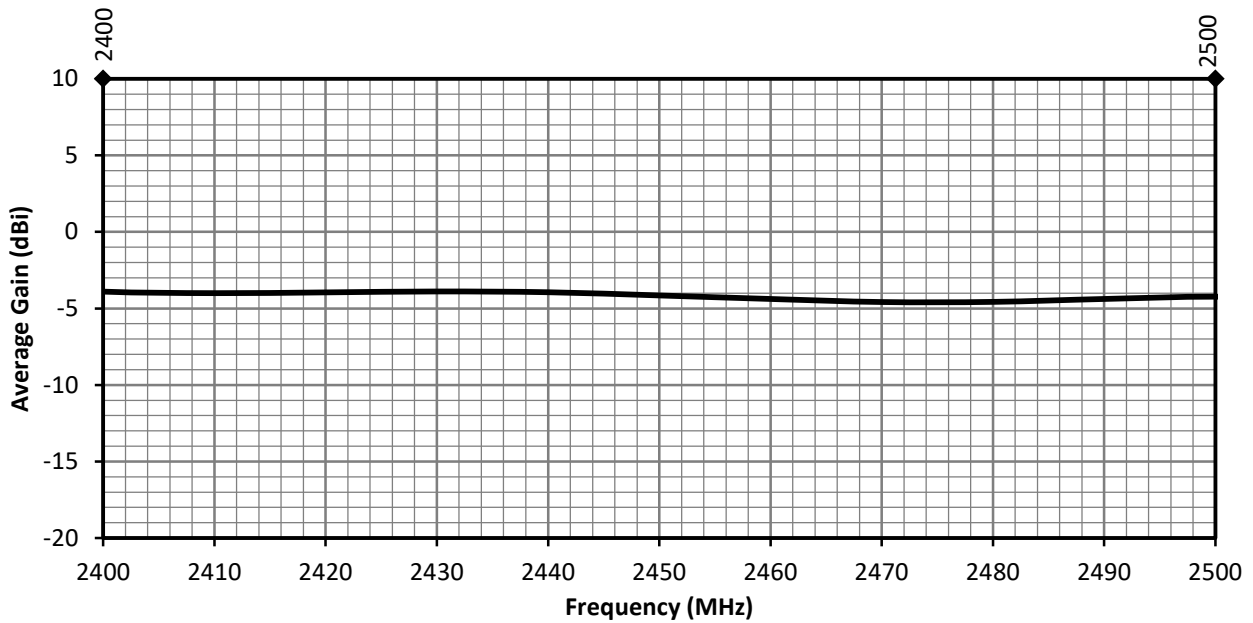

Figure 14. ANT-2.4-MMG1-SMA Antenna Average Gain, Free Space

Radiation Efficiency

Radiation efficiency (Figure 15), shows the ratio of power delivered to the antenna relative to the power radiated at the antenna, expressed as a percentage, where a higher percentage indicates better performance at a given frequency.

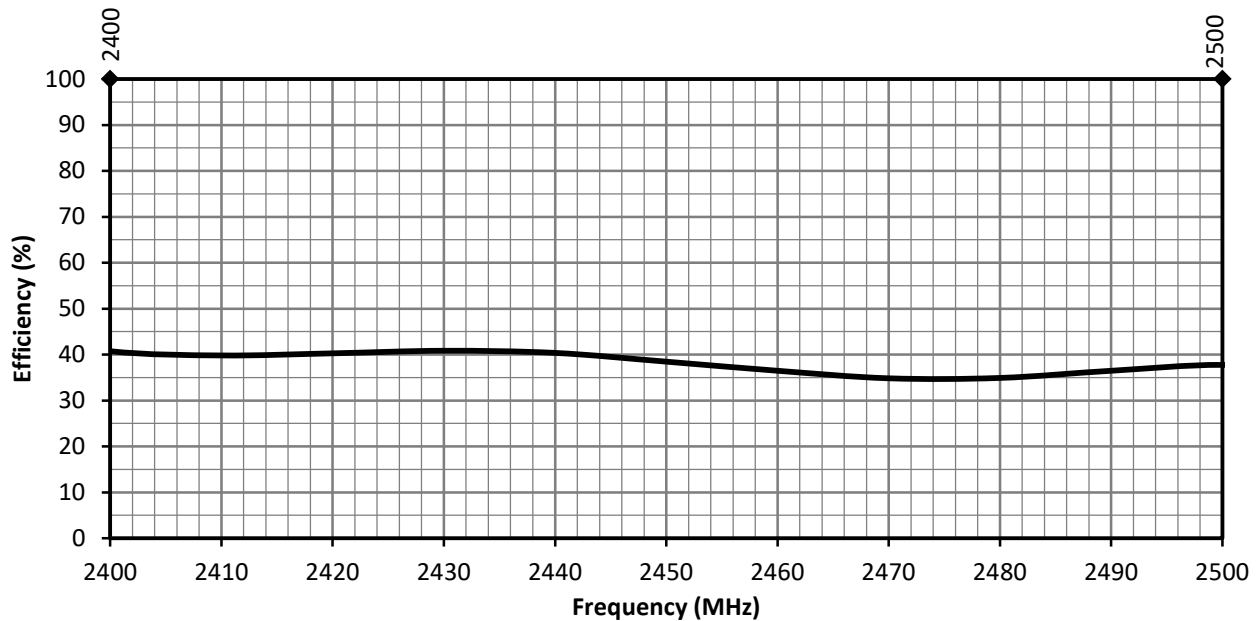

Figure 15. ANT-2.4-MMG1-SMA Antenna Radiation Efficiency, Free Space

Radiation Patterns

Radiation patterns provide information about the directionality and 3-dimensional gain performance of the antenna by plotting gain at specific frequencies in three orthogonal planes. Antenna radiation patterns (Figure 16), are shown using polar plots covering 360 degrees. The antenna graphic above the plots provides reference to the plane of the column of plots below it. Note: when viewed with typical PDF viewing software, zooming into radiation patterns is possible to reveal fine detail.

Radiation Patterns - Free Space



2400 MHz to 2500 MHz (2450 MHz)

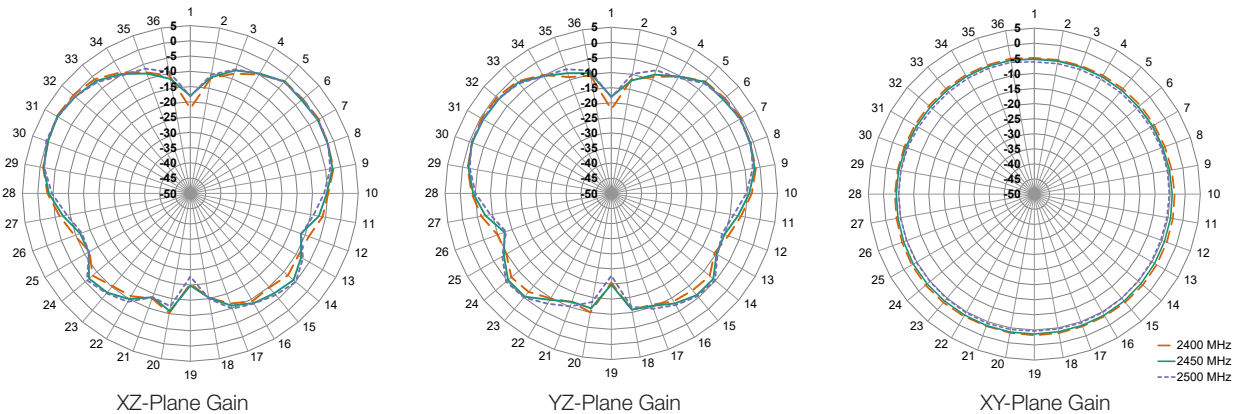

Figure 16. Radiation Patterns for ANT-2.4-MMG1-SMA Antenna, Free Space

Website: <http://linxtechnologies.com>
Linx Offices: 159 Ort Lane, Merlin, OR, US 97532
Phone: +1 (541) 471-6256
E-MAIL: info@linxtechnologies.com

Linx Technologies reserves the right to make changes to the product(s) or information contained herein without notice. No liability is assumed as a result of their use or application. No rights under any patent accompany the sale of any such product(s) or information.

Wireless Made Simple is a registered trademark of Linx Acquisitions LLC. Other product and brand names may be trademarks or registered trademarks of their respective owners.

Copyright © 2022 Linx Technologies

All Rights Reserved

Doc# DS22160-226ANT Replaces (DS22133-226ANT)

