

XPT IGBT

preliminary

$$V_{CES} = 1200V$$

$$I_{C25} = 20A$$

$$V_{CE(sat)} = 1.8V$$

Copack

Part number

IXA12IF1200HB

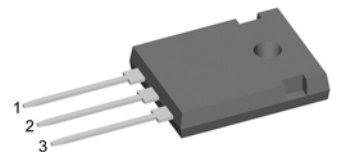

Backside: collector

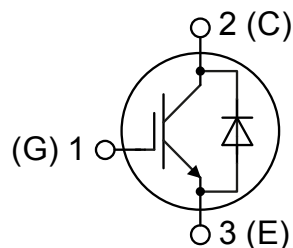
**Features / Advantages:**

- Easy paralleling due to the positive temperature coefficient of the on-state voltage
- Rugged XPT design (Xtreme light Punch Through) results in:
 - short circuit rated for 10 μ sec.
 - very low gate charge
 - low EMI
 - square RBSOA @ 3x I_c
- Thin wafer technology combined with the XPT design results in a competitive low $V_{CE(sat)}$
- SONIC™ diode
 - fast and soft reverse recovery
 - low operating forward voltage

Applications:

- AC motor drives
- Solar inverter
- Medical equipment
- Uninterruptible power supply
- Air-conditioning systems
- Welding equipment
- Switched-mode and resonant-mode power supplies
- Inductive heating, cookers
- Pumps, Fans

Package: TO-247

- Industry standard outline
- RoHS compliant
- Epoxy meets UL 94V-0

IGBT				Ratings			
Symbol	Definition	Conditions	min.	typ.	max.	Unit	
V_{CES}	collector emitter voltage	$T_{VJ} = 25^{\circ}C$			1200	V	
V_{GES}	max. DC gate voltage				± 20	V	
V_{GEM}	max. transient gate emitter voltage				± 30	V	
I_{C25}	collector current	$T_C = 25^{\circ}C$			20	A	
I_{C100}		$T_C = 100^{\circ}C$			13	A	
P_{tot}	total power dissipation	$T_C = 25^{\circ}C$			85	W	
$V_{CE(sat)}$	collector emitter saturation voltage	$I_C = 10A; V_{GE} = 15V$		1.8	2.1	V	
				2.1		V	
$V_{GE(th)}$	gate emitter threshold voltage	$I_C = 0.3mA; V_{CE} = V_{CE}$	5.4	5.9	6.5	V	
I_{CES}	collector emitter leakage current	$V_{CE} = V_{CES}; V_{GE} = 0V$			0.1	mA	
				0.1		mA	
I_{GES}	gate emitter leakage current	$V_{GE} = \pm 20V$			500	nA	
$Q_{G(on)}$	total gate charge	$V_{CE} = 600V; V_{GE} = 15V; I_C = 10A$		27		nC	
$t_{d(on)}$	turn-on delay time	inductive load $V_{CE} = 600V; I_C = 10A$ $V_{GE} = \pm 15V; R_G = 100\Omega$		70		ns	
t_r	current rise time		$T_{VJ} = 125^{\circ}C$		40		ns
$t_{d(off)}$	turn-off delay time				250		ns
t_f	current fall time				100		ns
E_{on}	turn-on energy per pulse				1.1		mJ
E_{off}	turn-off energy per pulse				1.1		mJ
RBSOA	reverse bias safe operating area	$V_{GE} = \pm 15V; R_G = 100\Omega$					
I_{CM}		$V_{CEmax} = 1200V$			30	A	
SCSOA	short circuit safe operating area	$V_{CEmax} = 900V$					
t_{sc}	short circuit duration	$V_{CE} = 900V; V_{GE} = \pm 15V$			10	μs	
I_{sc}	short circuit current	$R_G = 100\Omega; \text{non-repetitive}$		40		A	
R_{thJC}	thermal resistance junction to case				1.5	K/W	
R_{thCH}	thermal resistance case to heatsink			0.25		K/W	
Diode							
V_{RRM}	max. repetitive reverse voltage	$T_{VJ} = 25^{\circ}C$			1200	V	
I_{F25}	forward current	$T_C = 25^{\circ}C$			22	A	
I_{F100}		$T_C = 100^{\circ}C$			14	A	
V_F	forward voltage	$I_F = 10A$			2.20	V	
				1.95		V	
I_R	reverse current	$V_R = V_{RRM}$			*	mA	
	* not applicable, see Ices value above				*	mA	
Q_{rr}	reverse recovery charge	$V_R = 600V$ $-di_F/dt = -250A/\mu s$ $I_F = 10A; V_{GE} = 0V$		1.3		μC	
I_{RM}	max. reverse recovery current		$T_{VJ} = 125^{\circ}C$		10.5		A
t_{rr}	reverse recovery time				350		ns
E_{rec}	reverse recovery energy				0.35		mJ
R_{thJC}	thermal resistance junction to case				1.8	K/W	
R_{thCH}	thermal resistance case to heatsink			0.25		K/W	

preliminary

Package TO-247			Ratings			
Symbol	Definition	Conditions	min.	typ.	max.	Unit
I_{RMS}	RMS current	per terminal			70	A
T_{VJ}	virtual junction temperature		-40		150	°C
T_{op}	operation temperature		-40		125	°C
T_{stg}	storage temperature		-40		150	°C
Weight				6		g
M_D	mounting torque		0.8		1.2	Nm
F_C	mounting force with clip		20		120	N

Product Marking

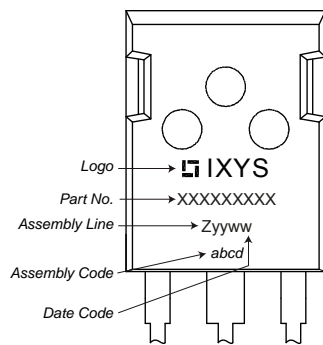

Part number

- I = IGBT
- X = XPT IGBT
- A = Gen 1 / std
- 12 = Current Rating [A]
- IF = Copack
- 1200 = Reverse Voltage [V]
- HB = TO-247AD (3)

Ordering	Part Number	Marking on Product	Delivery Mode	Quantity	Code No.
Standard	IXA12IF1200HB	IXA12IF1200HB	Tube	30	508453

Similar Part	Package	Voltage class
IXA12IF1200PB	TO-220AB (3)	1200
IXA12IF1200TC	TO-268AA (D3Pak) (2)	1200

Equivalent Circuits for Simulation

* on die level

$T_{VJ} = 150\text{ }^{\circ}\text{C}$

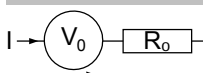

	IGBT	Diode	
$V_{0\text{ max}}$	1.1	1.25	V
$R_{0\text{ max}}$	153	85	mΩ

Outlines TO-247

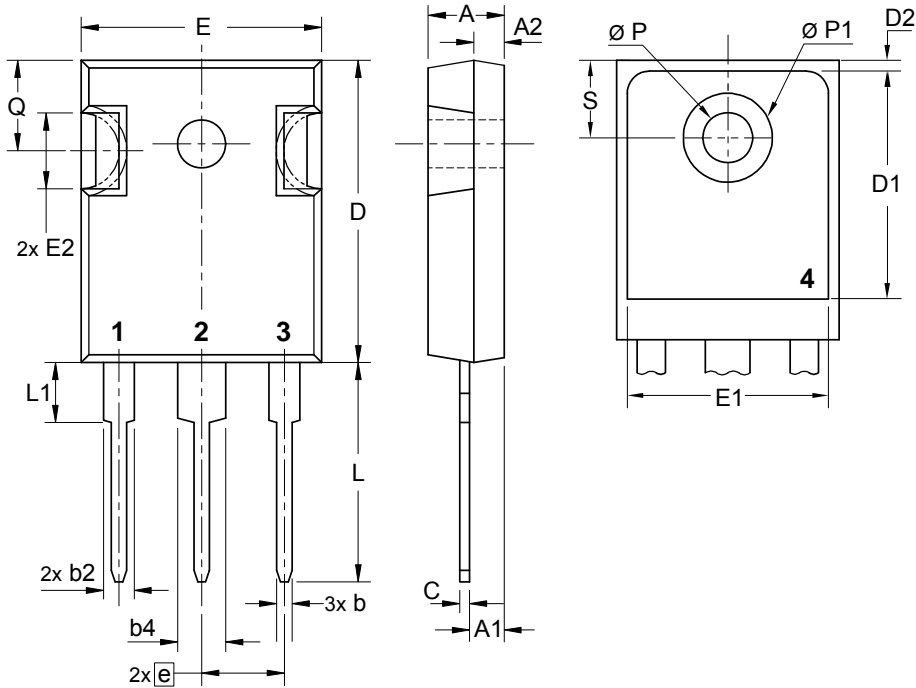

Sym.	Inches		Millimeter	
	min.	max.	min.	max.
A	0.185	0.209	4.70	5.30
A1	0.087	0.102	2.21	2.59
A2	0.059	0.098	1.50	2.49
D	0.819	0.845	20.79	21.45
E	0.610	0.640	15.48	16.24
E2	0.170	0.216	4.31	5.48
e	0.215 BSC		5.46 BSC	
L	0.780	0.800	19.80	20.30
L1	-	0.177	-	4.49
Ø P	0.140	0.144	3.55	3.65
Q	0.212	0.244	5.38	6.19
S	0.242 BSC		6.14 BSC	
b	0.039	0.055	0.99	1.40
b2	0.065	0.094	1.65	2.39
b4	0.102	0.135	2.59	3.43
c	0.015	0.035	0.38	0.89
D1	0.515	-	13.07	-
D2	0.020	0.053	0.51	1.35
E1	0.530	-	13.45	-
Ø P1	-	0.29	-	7.39

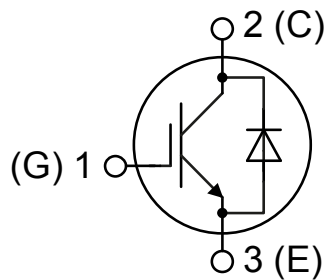

IGBT

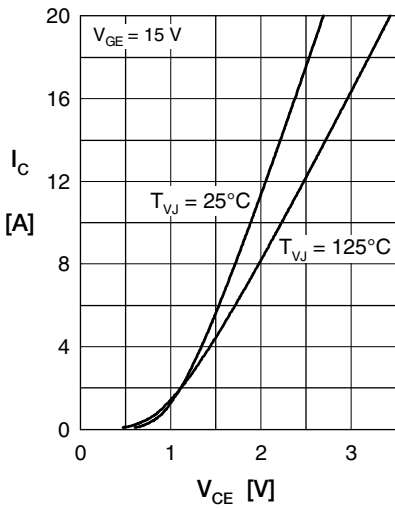

Fig. 1 Typ. output characteristics

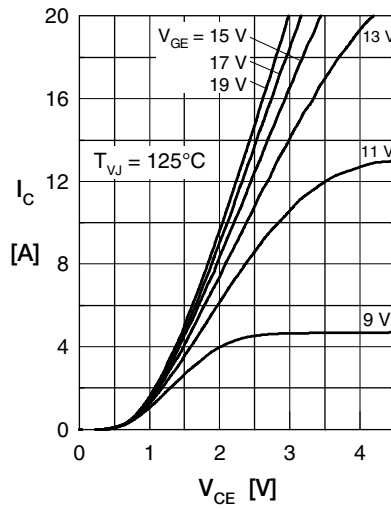

Fig. 2 Typ. output characteristics

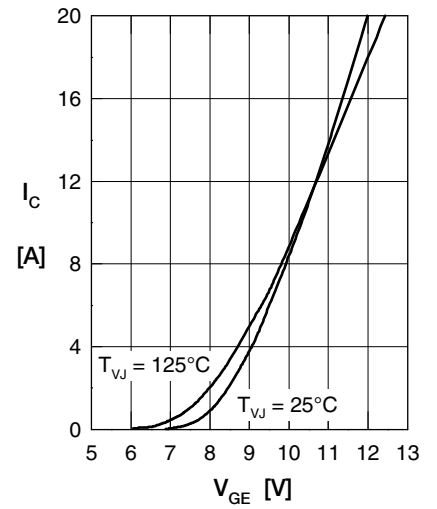

Fig. 3 Typ. transfer characteristics

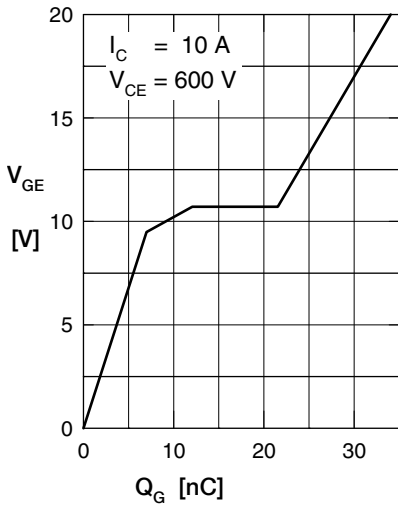

Fig. 4 Typ. turn-on gate charge

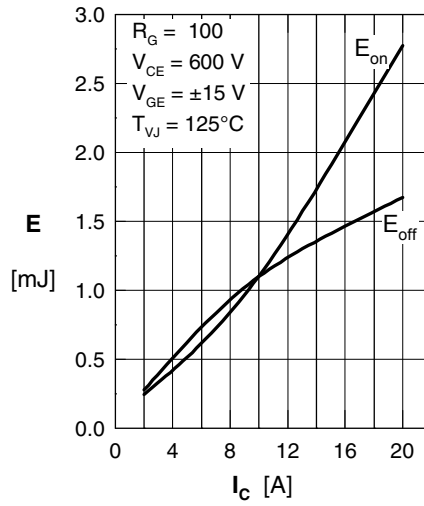

Fig. 5 Typ. switching energy vs. collector current

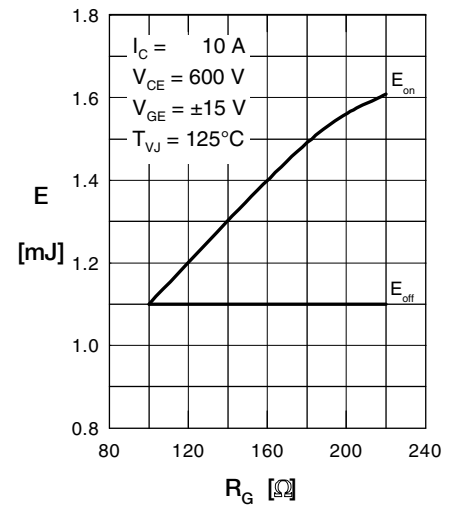

Fig. 6 Typ. switching energy vs. gate resistance

Fig. 7 Typ. transient thermal impedance junction to case

Diode

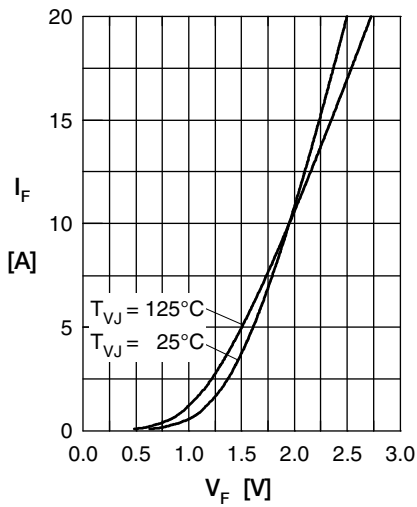

Fig. 1 Typ. forward current versus V_F

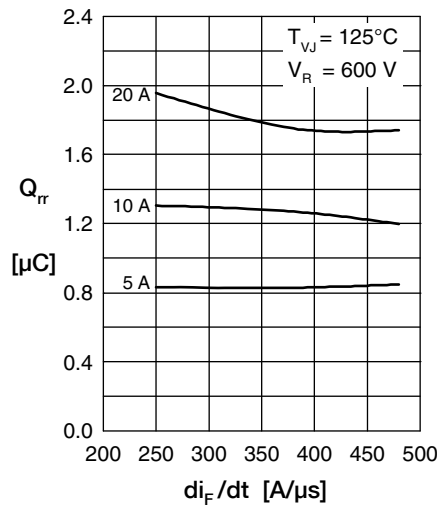

Fig. 2 Typical reverse recov. charge Q_{rr} versus di_F/dt

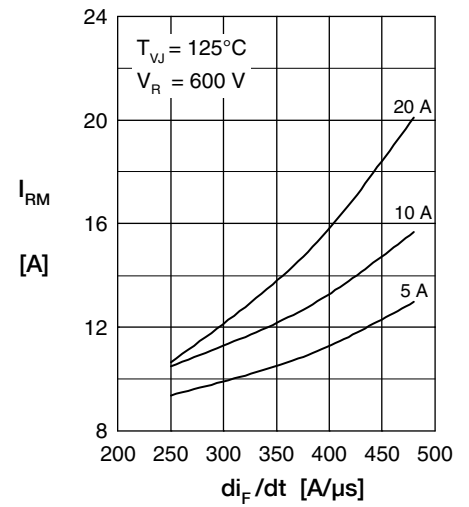

Fig. 3 Typ: peak reverse current I_{RM} versus di_F/dt

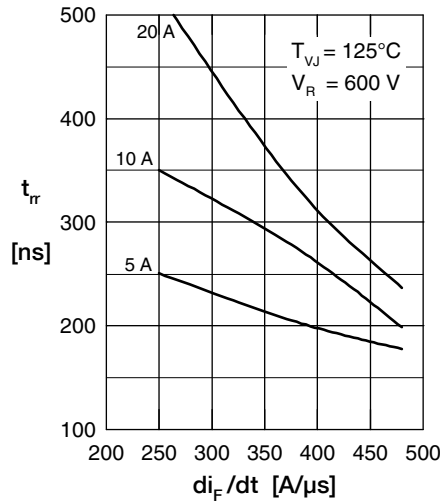

Fig. 4 Dynamic parameters Q_{rr} , I_{RM} versus T_{VJ}

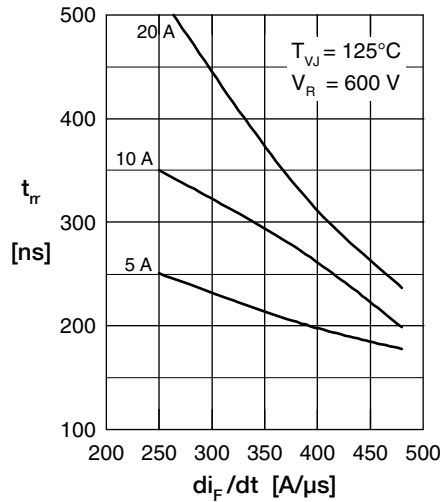

Fig. 5 Typ. recovery time t_{rr} versus di_F/dt

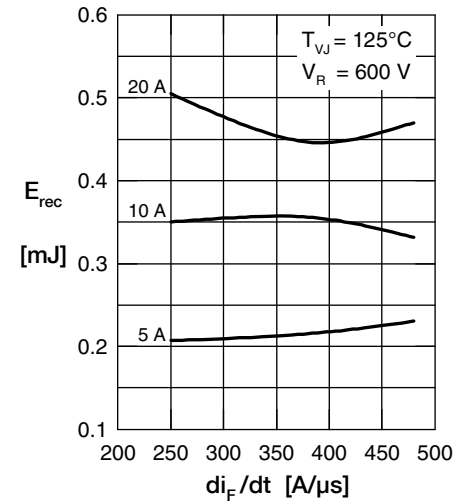

Fig. 6 Typ. recovery energy E_{rec} vs. di_F/dt

Fig. 7 Typ. transient thermal impedance junction to case