

## FEATURES

- Low offset voltage: 65  $\mu$ V maximum**
- Low input bias currents: 1 pA maximum**
- Low noise: 8 nV/ $\sqrt{\text{Hz}}$**
- Wide bandwidth: 10 MHz**
- High open-loop gain: 1000 V/mV**
- Unity gain stable**
- Single-supply operation: 2.7 V to 5.5 V**
- 5-ball WLCSP for single (AD8605) and 8-ball WLCSP for dual (AD8606)**

## APPLICATIONS

- Photodiode amplification**
- Battery-powered instrumentation**
- Multipole filters**
- Sensors**
- Barcode scanners**
- Audio**

## GENERAL DESCRIPTION

The AD8605, AD8606, and AD8608<sup>1</sup> are single, dual, and quad rail-to-rail input and output, single-supply amplifiers. They feature very low offset voltage, low input voltage and current noise, and wide signal bandwidth. They use the Analog Devices, Inc. patented DigiTrim<sup>®</sup> trimming technique, which achieves superior precision without laser trimming.

The combination of low offsets, low noise, very low input bias currents, and high speed makes these amplifiers useful in a wide variety of applications. Filters, integrators, photodiode amplifiers, and high impedance sensors all benefit from the combination of performance features. Audio and other ac applications benefit from the wide bandwidth and low distortion. Applications for these amplifiers include optical control loops, portable and loop-powered instrumentation, and audio amplification for portable devices.

The AD8605, AD8606, and AD8608 are specified over the extended industrial temperature range ( $-40^{\circ}\text{C}$  to  $+125^{\circ}\text{C}$ ). The AD8605 single is available in 5-lead SOT-23 and 5-ball WLCSP packages. The AD8606 dual is available in an 8-lead MSOP, an 8-ball WLCSP, and a narrow SOIC surface-mounted package. The AD8608 quad is available in a 14-lead TSSOP package and a narrow 14-lead SOIC package. The 5-ball and 8-ball WLCSP offer the smallest available footprint for any surface-mounted operational amplifier. The WLCSP, SOT-23, MSOP, and TSSOP versions are available in tape-and-reel only.

<sup>1</sup> Protected by U.S. Patent No. 5,969,657.

**Rev. O** **Document Feedback**  
 Information furnished by Analog Devices is believed to be accurate and reliable. However, no responsibility is assumed by Analog Devices for its use, nor for any infringements of patents or other rights of third parties that may result from its use. Specifications subject to change without notice. No license is granted by implication or otherwise under any patent or patent rights of Analog Devices. Trademarks and registered trademarks are the property of their respective owners.

## PIN CONFIGURATIONS

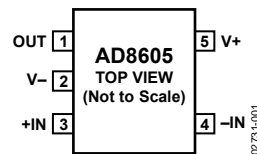

Figure 1. 5-Lead SOT-23 (RJ Suffix)

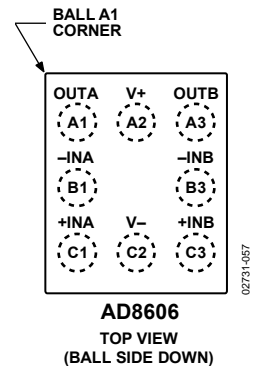

Figure 2. 8-Ball WLCSP (CB Suffix)

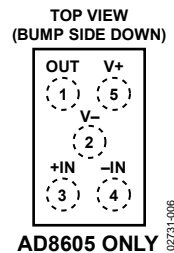

Figure 3. 5-Ball WLCSP (CB Suffix)

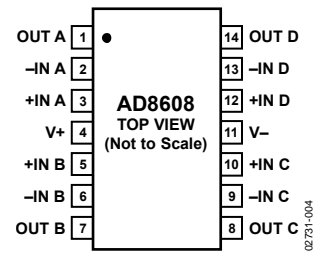

Figure 4. 14-Lead SOIC\_N (R Suffix)

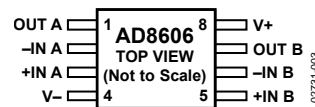

Figure 5. 8-Lead MSOP (RM Suffix),  
8-Lead SOIC\_N (R Suffix)

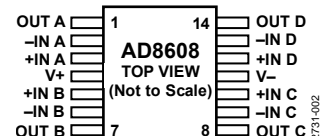

Figure 6. 14-Lead TSSOP (RU Suffix)



**1/2006—Rev. D to Rev. E**

Changes to Table 1 .....	3
Changes to Table 2 .....	5
Changes to Table 4 .....	6
Changes to Figure 12 Caption .....	8
Changes to Figure 26 and Figure 27 Captions.....	11
Changes to Figure 33 Caption .....	12
Changes to Figure 44 .....	14
Updated Outline Dimensions.....	19
Changes to Ordering Guide.....	20

**5/2004—Rev. C to Rev. D**

Updated Format.....	Universal
Edit to Light Sensitivity Section .....	16
Updated Outline Dimensions.....	19
Changes to Ordering Guide.....	20

**7/2003—Rev. B to Rev. C**

Changes to Features .....	1
Change to General Description.....	1
Addition to Functional Block Diagrams .....	1
Addition to Absolute Maximum Ratings .....	4
Addition to Ordering Guide .....	4
Change to Equation in Maximum Power Dissipation Section .....	11
Added Light Sensitivity Section .....	12

Added New Figure 8; Renumbered Subsequently .....	13
Added New MicroCSP Assembly Considerations Section.....	13
Changes to Figure 9 .....	13
Change to Equation in Photodiode Preamplifier	
Applications Section .....	13
Changes to Figure 12 .....	14
Change to Equation in D/A Conversion Section.....	14
Updated Outline Dimensions .....	15

**3/2003—Rev. A to Rev. B**

Changes to Functional Block Diagram .....	1
Changes to Absolute Maximum Ratings.....	4
Changes to Ordering Guide .....	4
Changes to Figure 9 .....	13
Updated Outline Dimensions.....	15

**11/2002—Rev. 0 to Rev. A**

Change to Electrical Characteristics.....	2
Changes to Absolute Maximum Ratings.....	4
Changes to Ordering Guide .....	4
Change to TPC 6 .....	5
Updated Outline Dimensions.....	15

**5/2002—Revision 0: Initial Version**

## 5 V ELECTRICAL SPECIFICATIONS

$V_S = 5\text{ V}$ ,  $V_{CM} = V_S/2$ ,  $T_A = 25^\circ\text{C}$ , unless otherwise noted.

Table 1.

Parameter	Symbol	Conditions	Min	Typ	Max	Unit
<b>INPUT CHARACTERISTICS</b>						
Offset Voltage	$V_{OS}$					
AD8605/AD8606 (Except WLCSP)		$V_S = 3.5\text{ V}$ , $V_{CM} = 3\text{ V}$		20	65	$\mu\text{V}$
AD8608		$V_S = 3.5\text{ V}$ , $V_{CM} = 2.7\text{ V}$		20	75	$\mu\text{V}$
AD8605/AD8606/AD8608		$V_S = 5\text{ V}$ , $V_{CM} = 0\text{ V to } 5\text{ V}$ $-40^\circ\text{C} < T_A < +125^\circ\text{C}$		80	300	$\mu\text{V}$
					750	$\mu\text{V}$
Input Bias Current	$I_B$			0.2	1	$\text{pA}$
AD8605/AD8606		$-40^\circ\text{C} < T_A < +85^\circ\text{C}$			50	$\text{pA}$
AD8605/AD8606		$-40^\circ\text{C} < T_A < +125^\circ\text{C}$			250	$\text{pA}$
AD8608		$-40^\circ\text{C} < T_A < +85^\circ\text{C}$			100	$\text{pA}$
AD8608		$-40^\circ\text{C} < T_A < +125^\circ\text{C}$			300	$\text{pA}$
Input Offset Current	$I_{OS}$			0.1	0.5	$\text{pA}$
		$-40^\circ\text{C} < T_A < +85^\circ\text{C}$			20	$\text{pA}$
		$-40^\circ\text{C} < T_A < +125^\circ\text{C}$			75	$\text{pA}$
Input Voltage Range			0		5	$\text{V}$
Common-Mode Rejection Ratio	CMRR	$V_{CM} = 0\text{ V to } 5\text{ V}$ $-40^\circ\text{C} < T_A < +125^\circ\text{C}$	85	100		$\text{dB}$
			75	90		$\text{dB}$
Large Signal Voltage Gain	$A_{VO}$	$R_L = 2\text{ k}\Omega$ , $V_O = 0.5\text{ V to } 4.5\text{ V}$	300	1000		$\text{V/mV}$
Offset Voltage Drift						
AD8605/AD8606	$\Delta V_{OS}/\Delta T$	$-40^\circ\text{C} < T_A < +125^\circ\text{C}$		1	4.5	$\mu\text{V}/^\circ\text{C}$
AD8608	$\Delta V_{OS}/\Delta T$	$-40^\circ\text{C} < T_A < +125^\circ\text{C}$		1.5	6.0	$\mu\text{V}/^\circ\text{C}$
<b>INPUT CAPACITANCE</b>						
Common-Mode Input Capacitance	$C_{COM}$			8.8		$\text{pF}$
Differential Input Capacitance	$C_{DIFF}$			2.6		$\text{pF}$
<b>OUTPUT CHARACTERISTICS</b>						
Output Voltage High	$V_{OH}$	$I_L = 1\text{ mA}$ $I_L = 10\text{ mA}$ $-40^\circ\text{C} < T_A < +125^\circ\text{C}$	4.96 4.7 4.6	4.98 4.79		$\text{V}$ $\text{V}$ $\text{V}$
Output Voltage Low	$V_{OL}$	$I_L = 1\text{ mA}$ $I_L = 10\text{ mA}$ $-40^\circ\text{C} < T_A < +125^\circ\text{C}$		20 170	40 210	$\text{mV}$ $\text{mV}$ $\text{mV}$
					290	$\text{mV}$
Output Current	$I_{OUT}$			$\pm 80$		$\text{mA}$
Closed-Loop Output Impedance	$Z_{OUT}$	$f = 1\text{ MHz}$ , $A_V = 1$		1		$\Omega$
<b>POWER SUPPLY</b>						
Power Supply Rejection Ratio	PSRR					
AD8605/AD8606		$V_S = 2.7\text{ V to } 5.5\text{ V}$	80	95		$\text{dB}$
AD8605/AD8606 WLCSP		$V_S = 2.7\text{ V to } 5.5\text{ V}$	75	92		$\text{dB}$
AD8608		$V_S = 2.7\text{ V to } 5.5\text{ V}$ $-40^\circ\text{C} < T_A < +125^\circ\text{C}$	77 70	92 90		$\text{dB}$ $\text{dB}$
Supply Current/Amplifier	$I_{SY}$	$I_{OUT} = 0\text{ mA}$ $-40^\circ\text{C} < T_A < +125^\circ\text{C}$		1	1.2 1.4	$\text{mA}$ $\text{mA}$
<b>DYNAMIC PERFORMANCE</b>						
Slew Rate	SR	$R_L = 2\text{ k}\Omega$ , $C_L = 16\text{ pF}$		5		$\text{V}/\mu\text{s}$
Settling Time	$t_s$	To 0.01%, 0 V to 2 V step, $A_V = 1$		<1		$\mu\text{s}$
Unity Gain Bandwidth Product	GBP			10		$\text{MHz}$
Phase Margin	$\Phi_M$			65		Degrees

Parameter	Symbol	Conditions	Min	Typ	Max	Unit
NOISE PERFORMANCE						
Peak-to-Peak Noise	$e_n$ p-p	$f = 0.1 \text{ Hz to } 10 \text{ Hz}$		2.3	3.5	$\mu\text{V p-p}$
Voltage Noise Density	$e_n$	$f = 1 \text{ kHz}$		8	12	$\text{nV}/\sqrt{\text{Hz}}$
	$e_n$	$f = 10 \text{ kHz}$		6.5		$\text{nV}/\sqrt{\text{Hz}}$
Current Noise Density	$i_n$	$f = 1 \text{ kHz}$		0.01		$\text{pA}/\sqrt{\text{Hz}}$

## 2.7 V ELECTRICAL SPECIFICATIONS

$V_S = 2.7\text{ V}$ ,  $V_{CM} = V_S/2$ ,  $T_A = 25^\circ\text{C}$ , unless otherwise noted.

Table 2.

Parameter	Symbol	Conditions	Min	Typ	Max	Unit
<b>INPUT CHARACTERISTICS</b>						
Offset Voltage	$V_{OS}$					
AD8605/AD8606 (Except WLCSP)		$V_S = 3.5\text{ V}$ , $V_{CM} = 3\text{ V}$		20	65	$\mu\text{V}$
AD8608		$V_S = 3.5\text{ V}$ , $V_{CM} = 2.7\text{ V}$		20	75	$\mu\text{V}$
AD8605/AD8606/AD8608		$V_S = 2.7\text{ V}$ , $V_{CM} = 0\text{ V to } 2.7\text{ V}$ $-40^\circ\text{C} < T_A < +125^\circ\text{C}$		80	300	$\mu\text{V}$
					750	$\mu\text{V}$
Input Bias Current	$I_B$			0.2	1	$\text{pA}$
AD8605/AD8606		$-40^\circ\text{C} < T_A < +85^\circ\text{C}$			50	$\text{pA}$
AD8605/AD8606		$-40^\circ\text{C} < T_A < +125^\circ\text{C}$			250	$\text{pA}$
AD8608		$-40^\circ\text{C} < T_A < +85^\circ\text{C}$			100	$\text{pA}$
AD8608		$-40^\circ\text{C} < T_A < +125^\circ\text{C}$			300	$\text{pA}$
Input Offset Current	$I_{OS}$			0.1	0.5	$\text{pA}$
		$-40^\circ\text{C} < T_A < +85^\circ\text{C}$			20	$\text{pA}$
		$-40^\circ\text{C} < T_A < +125^\circ\text{C}$			75	$\text{pA}$
Input Voltage Range			0		2.7	$\text{V}$
Common-Mode Rejection Ratio	CMRR	$V_{CM} = 0\text{ V to } 2.7\text{ V}$ $-40^\circ\text{C} < T_A < +125^\circ\text{C}$	80	95		$\text{dB}$
			70	85		$\text{dB}$
Large Signal Voltage Gain	$A_{VO}$	$R_L = 2\text{ k}\Omega$ , $V_O = 0.5\text{ V to } 2.2\text{ V}$	110	350		$\text{V/mV}$
Offset Voltage Drift						
AD8605/AD8606	$\Delta V_{OS}/\Delta T$	$-40^\circ\text{C} < T_A < +125^\circ\text{C}$		1	4.5	$\mu\text{V}/^\circ\text{C}$
AD8608	$\Delta V_{OS}/\Delta T$	$-40^\circ\text{C} < T_A < +125^\circ\text{C}$		1.5	6.0	$\mu\text{V}/^\circ\text{C}$
<b>INPUT CAPACITANCE</b>						
Common-Mode Input Capacitance	$C_{COM}$			8.8		$\text{pF}$
Differential Input Capacitance	$C_{DIFF}$			2.6		$\text{pF}$
<b>OUTPUT CHARACTERISTICS</b>						
Output Voltage High	$V_{OH}$	$I_L = 1\text{ mA}$ $-40^\circ\text{C} < T_A < +125^\circ\text{C}$	2.6	2.66		$\text{V}$
			2.6			$\text{V}$
Output Voltage Low	$V_{OL}$	$I_L = 1\text{ mA}$ $-40^\circ\text{C} < T_A < +125^\circ\text{C}$		25	40	$\text{mV}$
					50	$\text{mV}$
Output Current	$I_{OUT}$			$\pm 30$		$\text{mA}$
Closed-Loop Output Impedance	$Z_{OUT}$	$f = 1\text{ MHz}$ , $A_V = 1$		1.2		$\Omega$
<b>POWER SUPPLY</b>						
Power Supply Rejection Ratio	PSRR					
AD8605/AD8606		$V_S = 2.7\text{ V to } 5.5\text{ V}$	80	95		$\text{dB}$
AD8605/AD8606 WLCSP		$V_S = 2.7\text{ V to } 5.5\text{ V}$	75	92		$\text{dB}$
AD8608		$V_S = 2.7\text{ V to } 5.5\text{ V}$ $-40^\circ\text{C} < T_A < +125^\circ\text{C}$	77	92		$\text{dB}$
			70	90		$\text{dB}$
Supply Current/Amplifier	$I_{SY}$	$I_{OUT} = 0\text{ mA}$ $-40^\circ\text{C} < T_A < +125^\circ\text{C}$		1.15	1.4	$\text{mA}$
					1.5	$\text{mA}$
<b>DYNAMIC PERFORMANCE</b>						
Slew Rate	SR	$R_L = 2\text{ k}\Omega$ , $C_L = 16\text{ pF}$		5		$\text{V}/\mu\text{s}$
Settling Time	$t_s$	To 0.01%, 0 V to 1 V step, $A_V = 1$		<0.5		$\mu\text{s}$
Unity Gain Bandwidth Product	GBP			9		$\text{MHz}$
Phase Margin	$\Phi_M$			50		Degrees

Parameter	Symbol	Conditions	Min	Typ	Max	Unit
NOISE PERFORMANCE						
Peak-to-Peak Noise	$e_n$ p-p	$f = 0.1 \text{ Hz to } 10 \text{ Hz}$		2.3	3.5	$\mu\text{V p-p}$
Voltage Noise Density	$e_n$	$f = 1 \text{ kHz}$		8	12	$\text{nV}/\sqrt{\text{Hz}}$
	$e_n$	$f = 10 \text{ kHz}$		6.5		$\text{nV}/\sqrt{\text{Hz}}$
Current Noise Density	$i_n$	$f = 1 \text{ kHz}$		0.01		$\text{pA}/\sqrt{\text{Hz}}$

## ABSOLUTE MAXIMUM RATINGS

Table 3.

Parameter	Rating
Supply Voltage	6 V
Input Voltage	GND to $V_S$
Differential Input Voltage	6 V
Output Short-Circuit Duration to GND	Observe Derating Curves
Storage Temperature Range	
All Packages	−65°C to +150°C
Operating Temperature Range	
All Packages	−40°C to +125°C
Junction Temperature Range	
All Packages	−65°C to +150°C
Lead Temperature (Soldering, 60 sec)	300°C

Stresses at or above those listed under Absolute Maximum Ratings may cause permanent damage to the product. This is a stress rating only; functional operation of the product at these or any other conditions above those indicated in the operational section of this specification is not implied. Operation beyond the maximum operating conditions for extended periods may affect product reliability.

Table 4.

Package Type	$\theta_{JA}^1$	$\theta_{JC}$	Unit
5-Ball WLCSP (CB)	170		°C/W
5-Lead SOT-23 (RJ)	240	92	°C/W
8-Ball WLCSP (CB)	115		°C/W
8-Lead MSOP (RM)	206	44	°C/W
8-Lead SOIC_N (R)	157	56	°C/W
14-Lead SOIC_N (R)	105	36	°C/W
14-Lead TSSOP (RU)	148	23	°C/W

<sup>1</sup>  $\theta_{JA}$  is specified for the worst-case conditions, that is, a device soldered in a circuit board for surface-mount packages.

### ESD CAUTION



**ESD (electrostatic discharge) sensitive device.** Charged devices and circuit boards can discharge without detection. Although this product features patented or proprietary protection circuitry, damage may occur on devices subjected to high energy ESD. Therefore, proper ESD precautions should be taken to avoid performance degradation or loss of functionality.



# TYPICAL PERFORMANCE CHARACTERISTICS

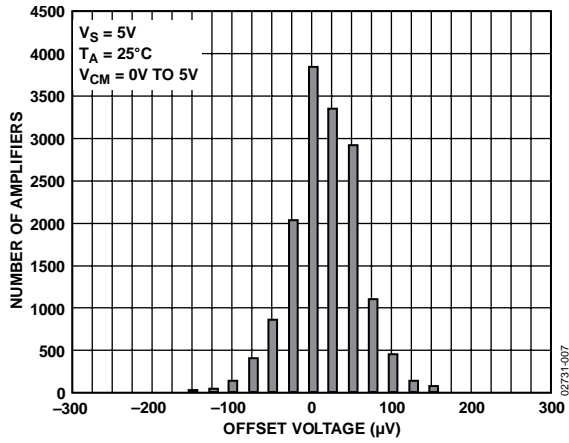

Figure 7. Input Offset Voltage Distribution

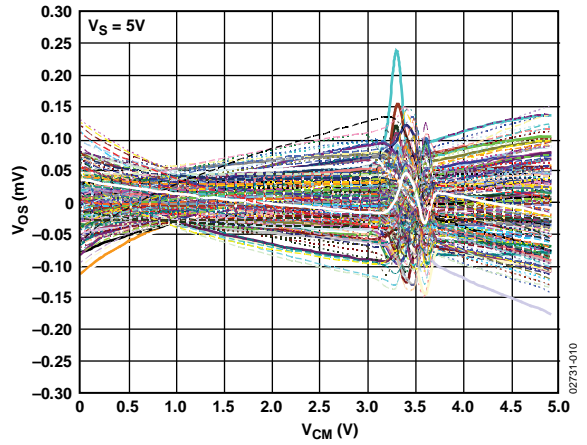

Figure 10. Input Offset Voltage vs. Common-Mode Voltage (200 Units, 5 Wafer Lots, Including Process Skews)

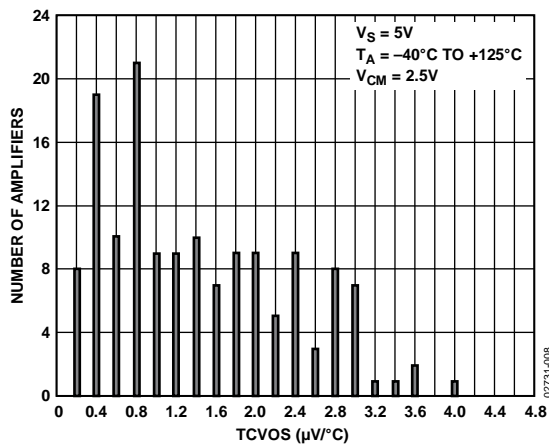

Figure 8. AD8608 Input Offset Voltage Drift Distribution

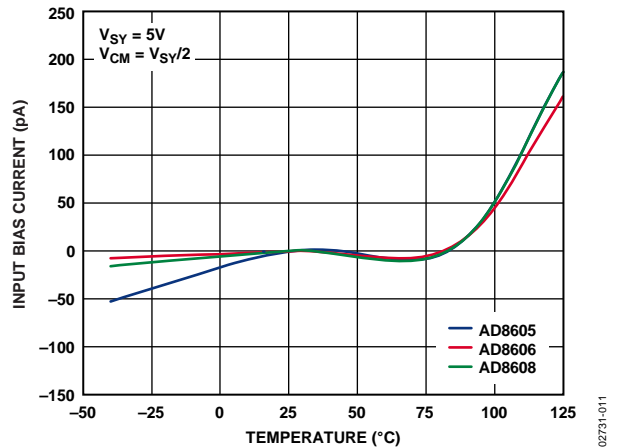

Figure 11. Input Bias Current vs. Temperature

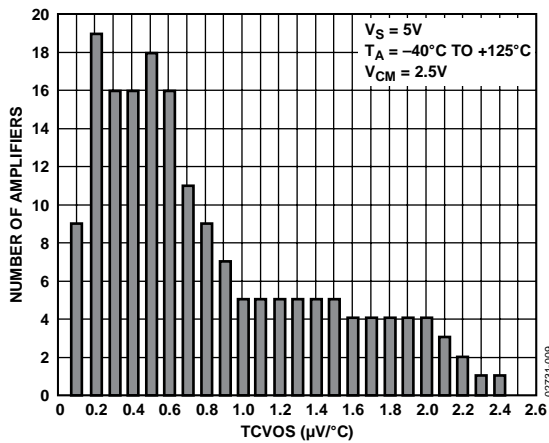

Figure 9. AD8605/AD8606 Input Offset Voltage Drift Distribution

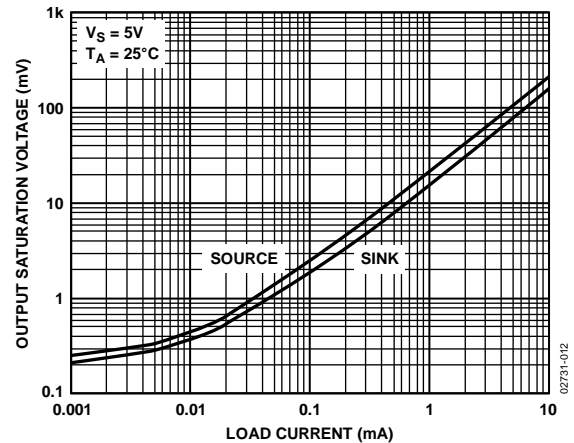

Figure 12. Output Saturation Voltage vs. Load Current

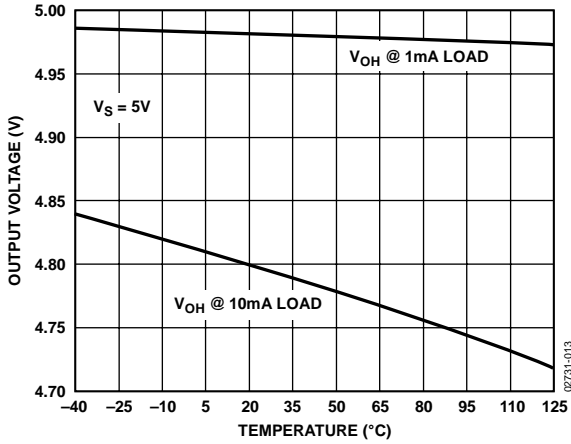

Figure 13. Output Voltage Swing High vs. Temperature

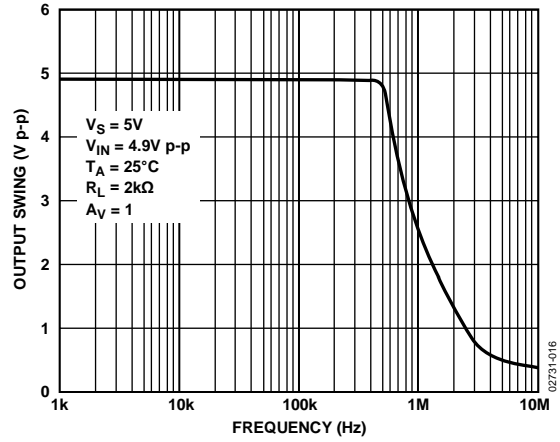

Figure 16. Closed-Loop Output Voltage Swing (FPBW)

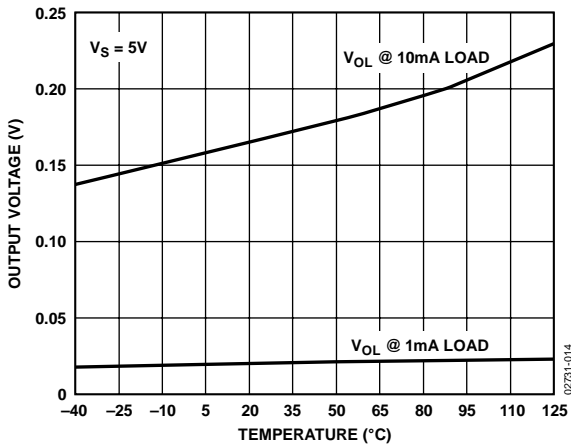

Figure 14. Output Voltage Swing Low vs. Temperature

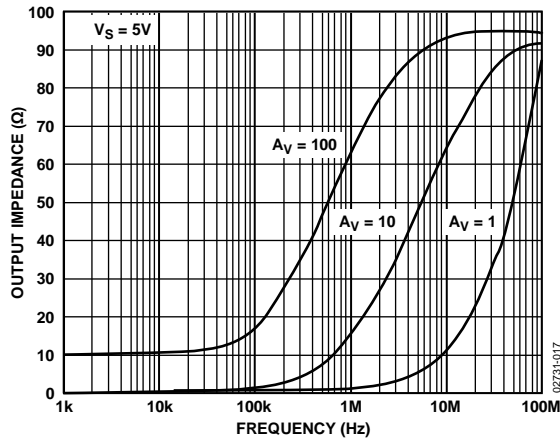

Figure 17. Output Impedance vs. Frequency

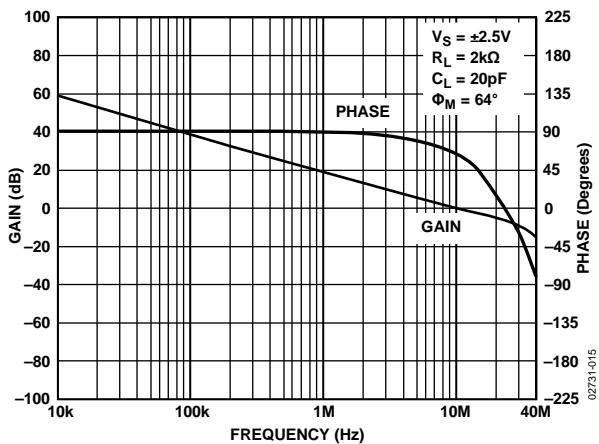

Figure 15. Open-Loop Gain and Phase vs. Frequency

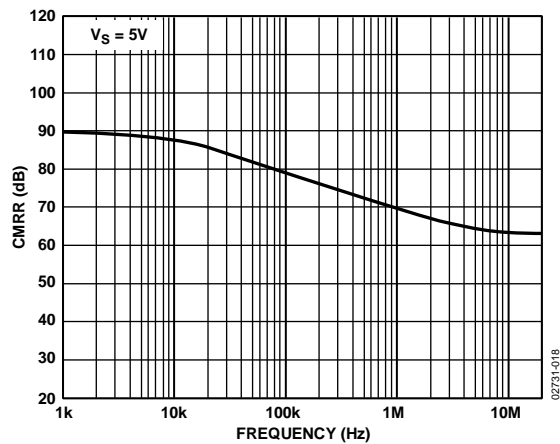

Figure 18. Common-Mode Rejection Ratio (CMRR) vs. Frequency

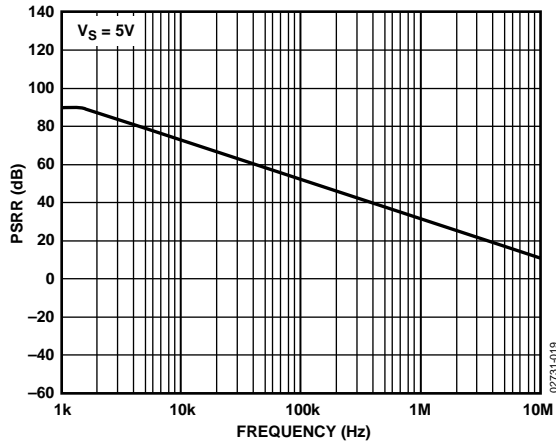

Figure 19. PSRR vs. Frequency

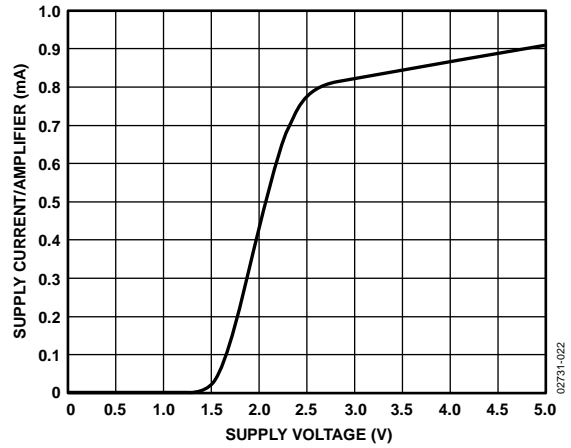

Figure 22. Supply Current/Amplifier vs. Supply Voltage

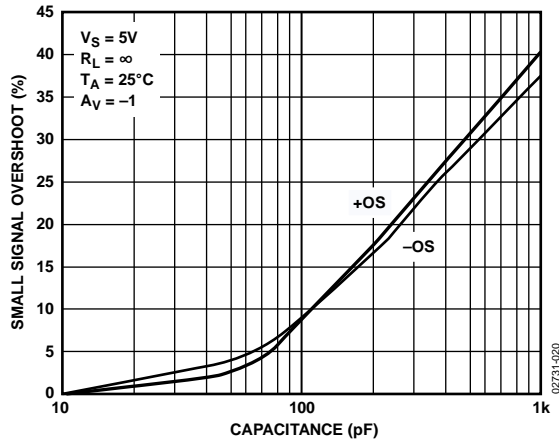

Figure 20. Small Signal Overshoot vs. Load Capacitance

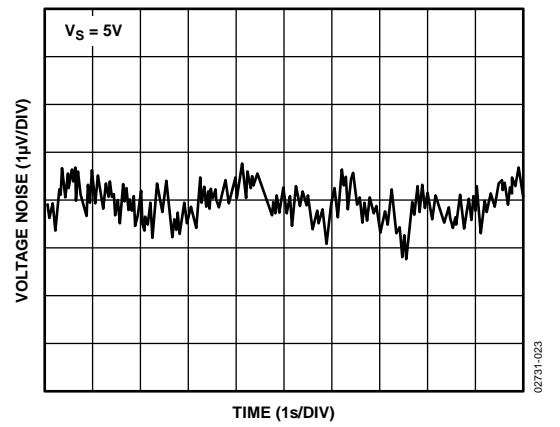

Figure 23. 0.1 Hz to 10 Hz Input Voltage Noise

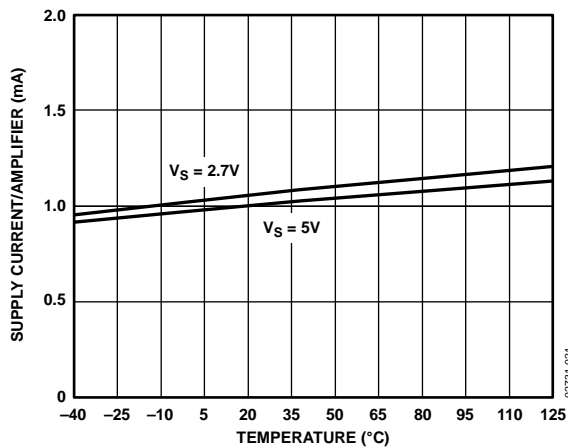

Figure 21. Supply Current/Amplifier vs. Temperature

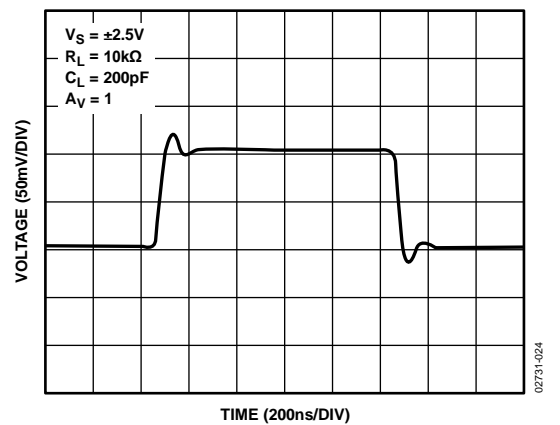

Figure 24. Small Signal Transient Response

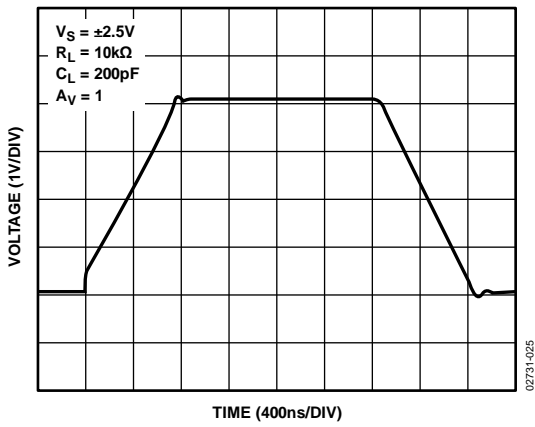

Figure 25. Large Signal Transient Response

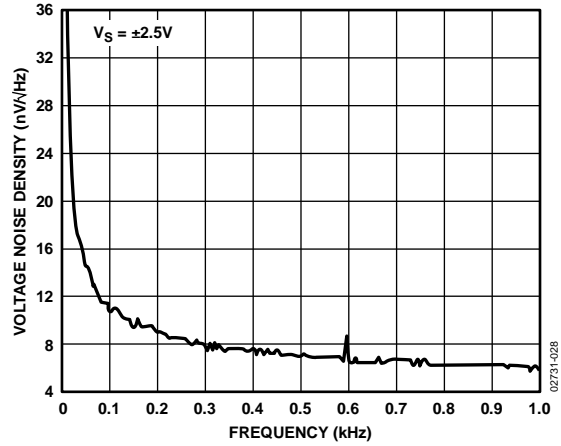

Figure 28. Voltage Noise Density vs. Frequency

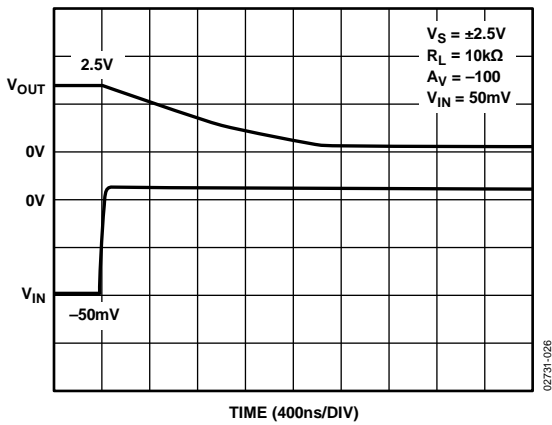

Figure 26. Positive Overload Recovery

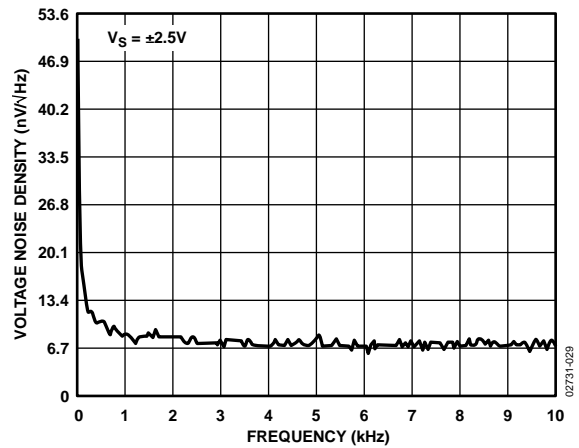

Figure 29. Voltage Noise Density vs. Frequency

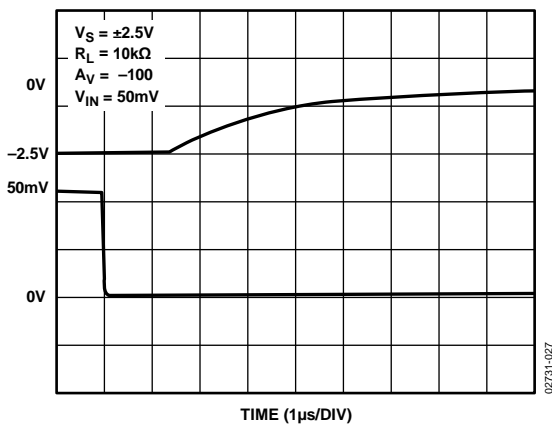

Figure 27. Negative Overload Recovery

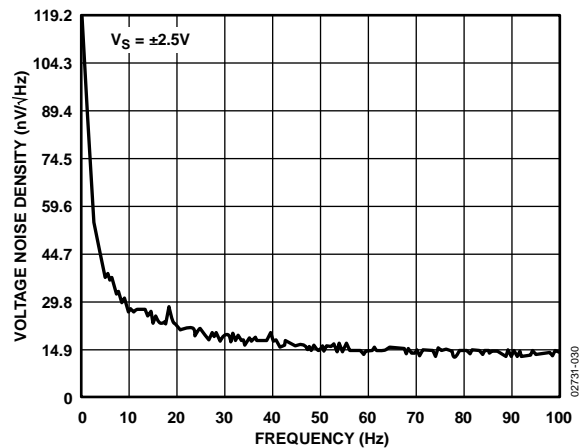

Figure 30. Voltage Noise Density vs. Frequency

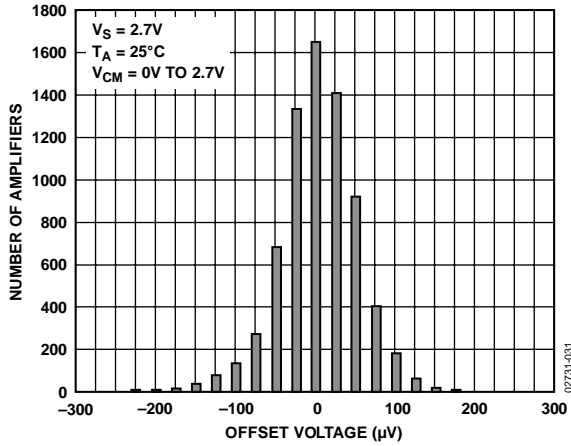

Figure 31. Input Offset Voltage Distribution

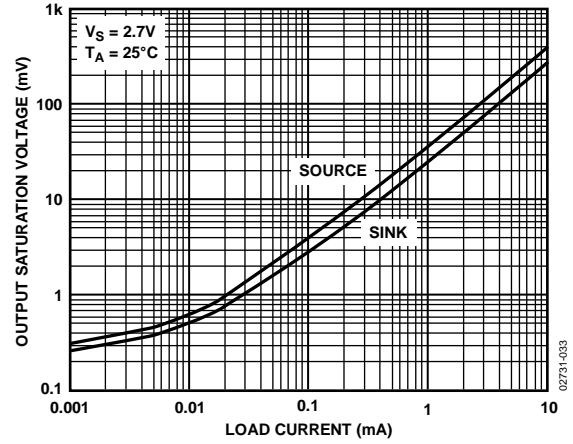

Figure 34. Output Saturation Voltage vs. Load Current

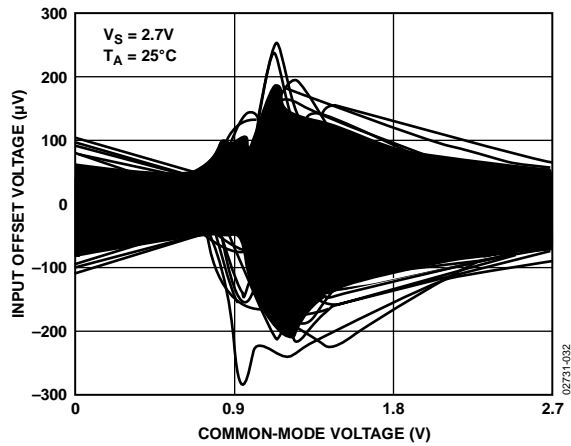

Figure 32. Input Offset Voltage vs. Common-Mode Voltage (200 Units, 5 Wafer Lots, Including Process Skews)

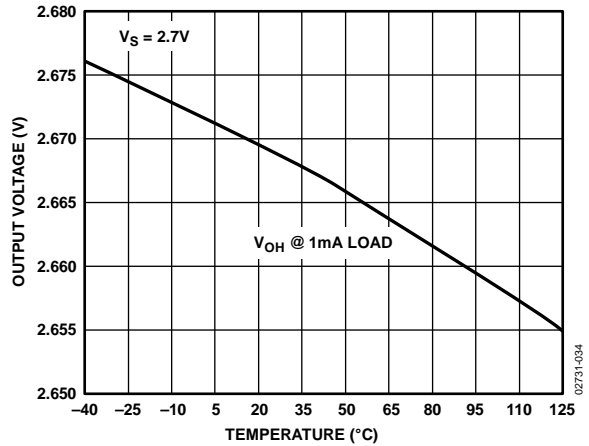

Figure 35. Output Voltage Swing High vs. Temperature

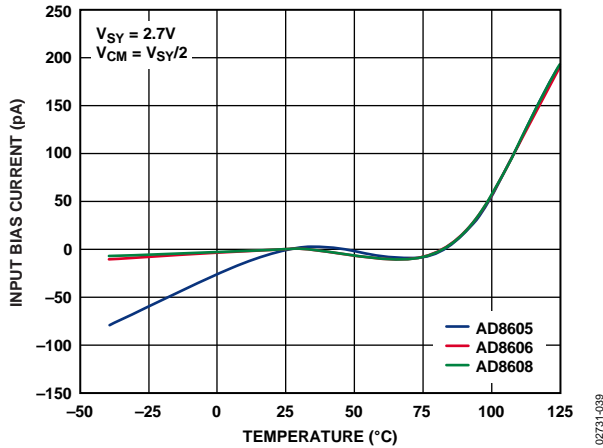

Figure 33. Input Bias Current vs. Temperature

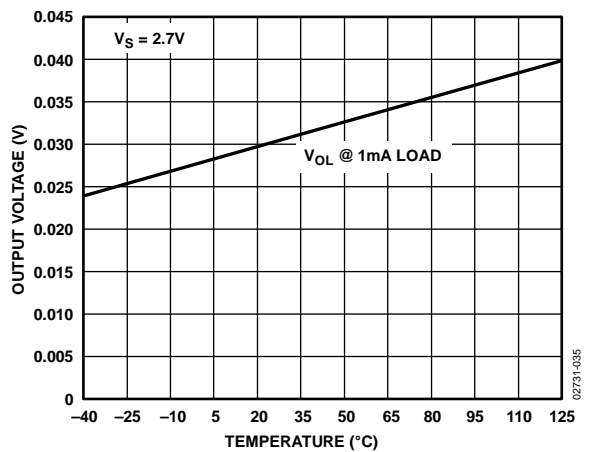

Figure 36. Output Voltage Swing Low vs. Temperature

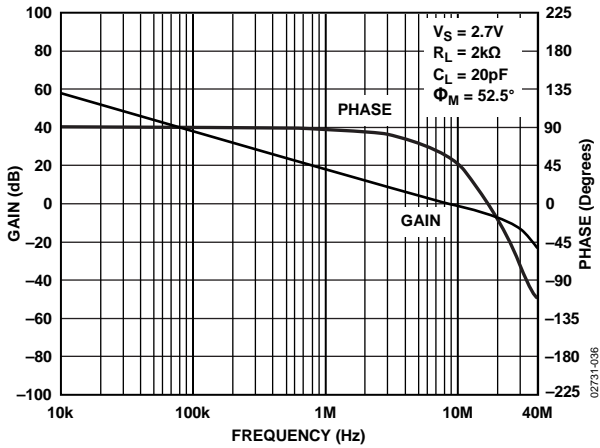

Figure 37. Open-Loop Gain and Phase vs. Frequency

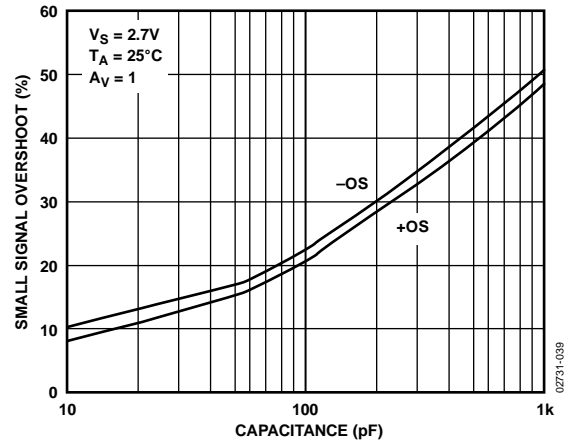

Figure 40. Small Signal Overshoot vs. Load Capacitance

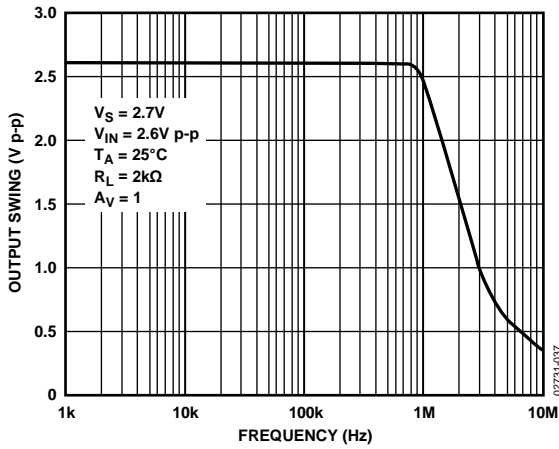

Figure 38. Closed-Loop Output Voltage Swing vs. Frequency (FPBW)

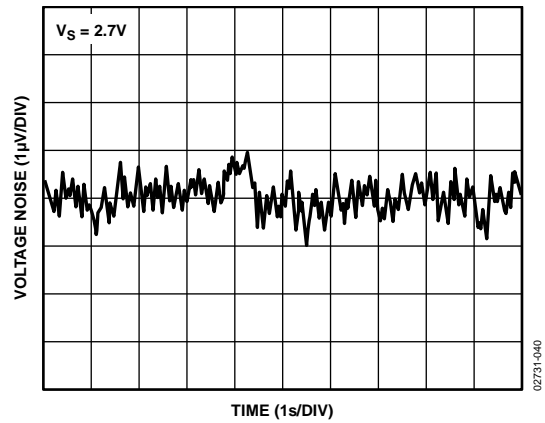

Figure 41. 0.1 Hz to 10 Hz Input Voltage Noise

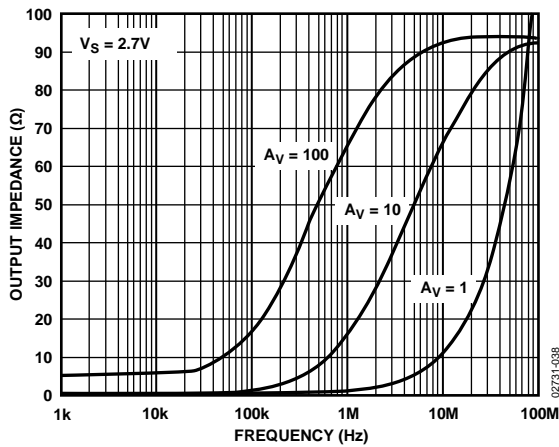

Figure 39. Output Impedance vs. Frequency

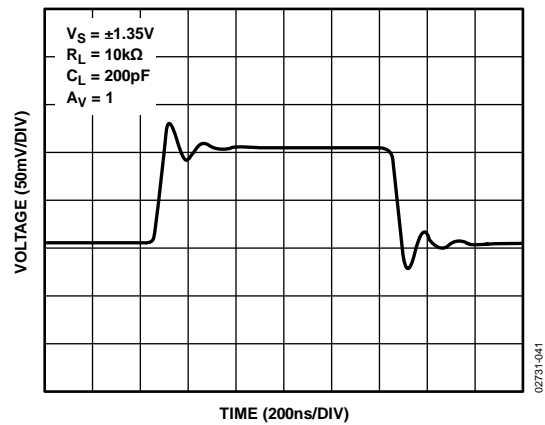

Figure 42. Small Signal Transient Response

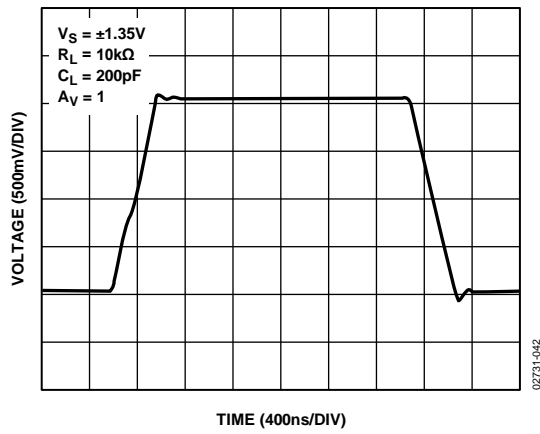

Figure 43. Large Signal Transient Response

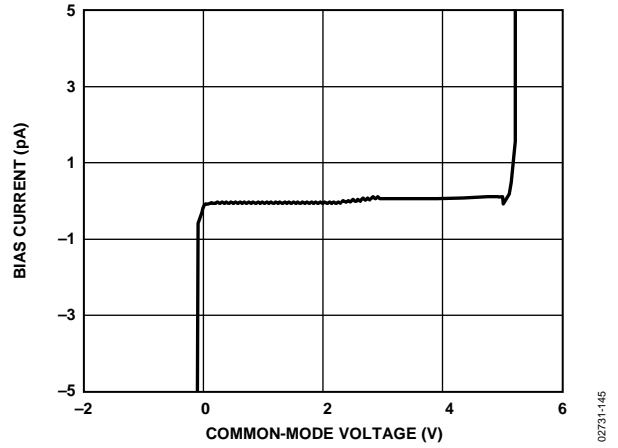

Figure 45. Noninverting Input Bias Current vs Common-Mode Voltage

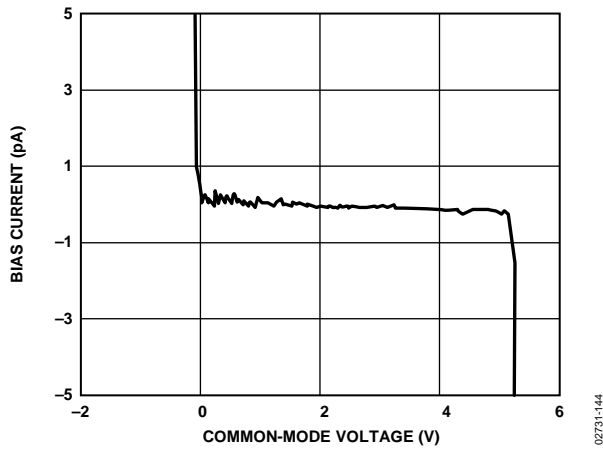

Figure 44. Inverting Input Bias Current vs Common-Mode Voltage

## APPLICATIONS INFORMATION

### OUTPUT PHASE REVERSAL

Phase reversal is defined as a change in polarity at the output of the amplifier when a voltage that exceeds the maximum input common-mode voltage drives the input.

Phase reversal can cause permanent damage to the amplifier; it can also cause system lockups in feedback loops. The AD8605 does not exhibit phase reversal even for inputs exceeding the supply voltage by more than 2 V.

### MAXIMUM POWER DISSIPATION

Power dissipated in an IC causes the die temperature to increase, which can affect the behavior of the IC and the application circuit performance.

The absolute maximum junction temperature of the AD8605/AD8606/AD8608 is 150°C. Exceeding this temperature could damage or destroy the device.

The maximum power dissipation of the amplifier is calculated according to

$$P_{DISS} = \frac{T_J - T_A}{\theta_{JA}}$$

where:

$T_J$  is the junction temperature.

$T_A$  is the ambient temperature.

$\theta_{JA}$  is the junction-to-ambient thermal resistance.

Figure 47 compares the maximum power dissipation with temperature for the various AD860x family packages.

### INPUT OVERVOLTAGE PROTECTION

The AD860x has internal protective circuitry. However, if the voltage applied at either input exceeds the supplies by more than 0.5 V, external resistors should be placed in series with the inputs. The resistor values can be determined by

$$\frac{V_{IN} - V_S}{R_S} \leq 5 \text{ mA}$$

The remarkable low input offset current of the AD860x (<1 pA) allows the use of larger value resistors. With a 10 kΩ resistor at the input, the output voltage has less than 10 nV of error voltage. A 10 kΩ resistor has less than 13 nV/√Hz of thermal noise at room temperature.

### THD + NOISE

Total harmonic distortion is the ratio of the input signal in V rms to the total harmonics in V rms throughout the spectrum. Harmonic distortion adds errors to precision measurements and adds unpleasant sonic artifacts to audio systems.

The AD860x has a low total harmonic distortion. Figure 48 shows that the AD8605 has less than 0.005% or -86 dB of THD + N over the entire audio frequency range. The AD8605 is configured in positive unity gain, which is the worst case, and with a load of 10 kΩ.

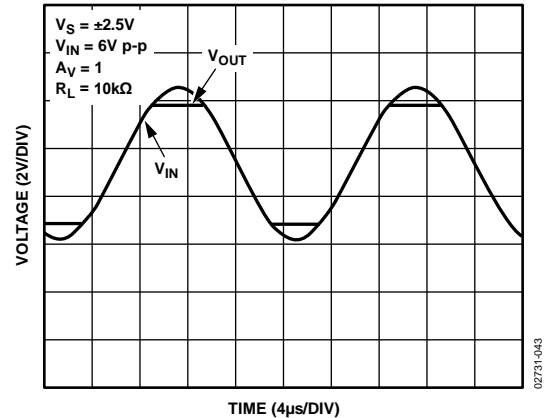

Figure 46. No Phase Reversal

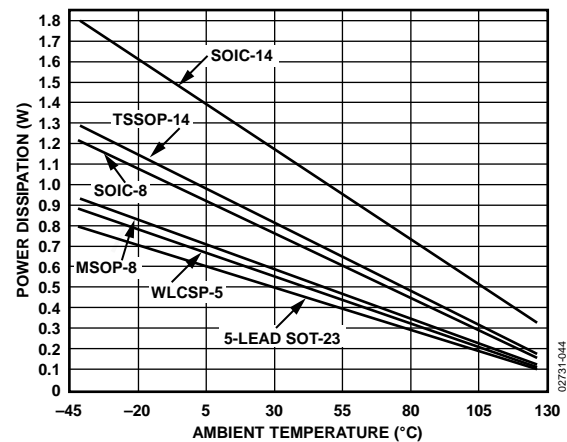

Figure 47. Maximum Power Dissipation vs. Ambient Temperature

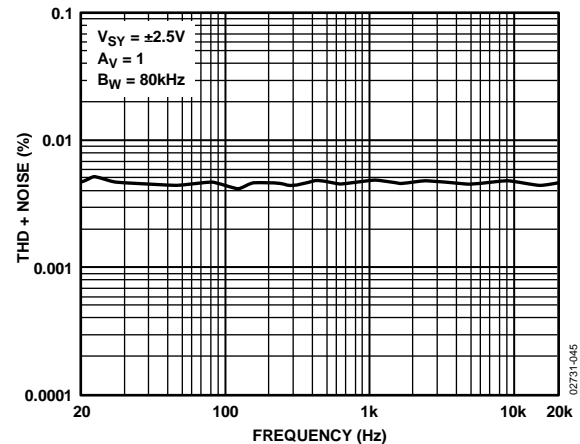

Figure 48. THD + Noise vs. Frequency



**TOTAL NOISE INCLUDING SOURCE RESISTORS**

The low input current noise and input bias current of the AD860x make it the ideal amplifier for circuits with substantial input source resistance, such as photodiodes. Input offset voltage increases by less than 0.5 nV per 1 kΩ of source resistance at room temperature and increases to 10 nV at 85°C. The total noise density of the circuit is

$$e_{n,TOTAL} = \sqrt{e_n^2 + (i_n R_s)^2 + 4kTR_s}$$

where:

$e_n$  is the input voltage noise density of the AD860x.

$i_n$  is the input current noise density of the AD860x.

$R_s$  is the source resistance at the noninverting terminal.

$k$  is Boltzmann's constant ( $1.38 \times 10^{-23}$  J/K).

$T$  is the ambient temperature in Kelvin ( $T = 273 + ^\circ\text{C}$ ).

For example, with  $R_s = 10$  kΩ, the total voltage noise density is roughly  $15$  nV/ $\sqrt{\text{Hz}}$ .

For  $R_s < 3.9$  kΩ,  $e_n$  dominates and  $e_{n,TOTAL} \approx e_n$ .

The current noise of the AD860x is so low that its total density does not become a significant term unless  $R_s$  is greater than  $6$  MΩ.

The total equivalent rms noise over a specific bandwidth is expressed as

$$E_n = (e_{n,TOTAL}) \sqrt{BW}$$

where  $BW$  is the bandwidth in hertz.

Note that the previous analysis is valid for frequencies greater than 100 Hz and assumes relatively flat noise, above 10 kHz. For lower frequencies, flicker noise ( $1/f$ ) must be considered.

**CHANNEL SEPARATION**

Channel separation, or inverse crosstalk, is a measure of the signal feed from one amplifier (channel) to another on the same IC.

The AD8606 has a channel separation of greater than  $-160$  dB up to frequencies of 1 MHz, allowing the two amplifiers to amplify ac signals independently in most applications.

**CAPACITIVE LOAD DRIVE**

The AD860x can drive large capacitive loads without oscillation. Figure 50 shows the output of the AD8606 in response to a 200 mV input signal. In this case, the amplifier is configured in positive unity gain, worst case for stability, while driving a 1000 pF load at its output. Driving larger capacitive loads in unity gain can require the use of additional circuitry.

A snubber network, shown in Figure 51, helps reduce the signal overshoot to a minimum and maintain stability. Although this circuit does not recover the loss of bandwidth induced by large capacitive loads, it greatly reduces the overshoot and ringing. This method does not reduce the maximum output swing of the amplifier.

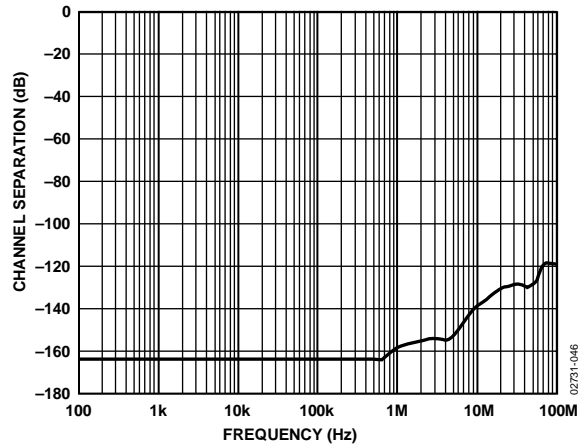

Figure 49. Channel Separation vs. Frequency

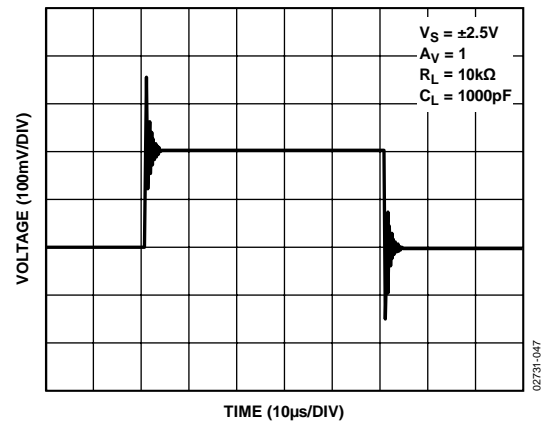

Figure 50. AD8606 Capacitive Load Drive Without Snubber

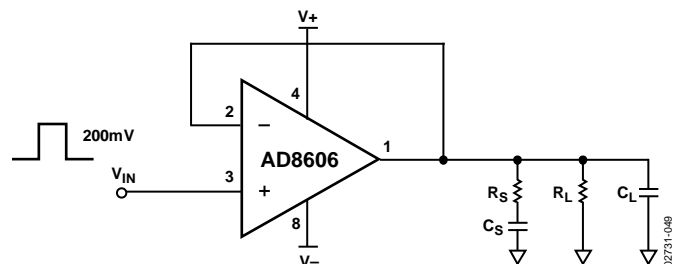

Figure 51. Snubber Network Configuration

Figure 52 shows a scope of the output at the snubber circuit. The overshoot is reduced from over 70% to less than 5%, and the ringing is eliminated by the snubber. Optimum values for  $R_s$  and  $C_s$  are determined experimentally.

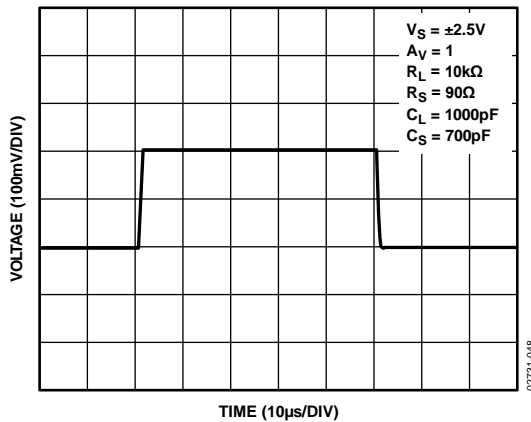

Figure 52. Capacitive Load Drive with Snubber

Table 5 summarizes a few optimum values for capacitive loads.

Table 5.

$C_L$ (pF)	$R_s$ ( $\Omega$ )	$C_s$ (pF)
500	100	1000
1000	70	1000
2000	60	800

An alternate technique is to insert a series resistor inside the feedback loop at the output of the amplifier. Typically, the value of this resistor is approximately 100  $\Omega$ . This method also reduces overshoot and ringing but causes a reduction in the maximum output swing.

## LIGHT SENSITIVITY

The AD8605ACB (WLCSP package option) is essentially a silicon die with additional postfabrication dielectric and intermetallic processing designed to contact solder bumps on the active side of the chip. With this package type, the die is exposed to ambient light and is subject to photoelectric effects. Light sensitivity analysis of the AD8605ACB mounted on standard PCB material reveals that only the input bias current ( $I_B$ ) parameter is impacted when the package is illuminated directly by high intensity light. No degradation in electrical performance is observed due to illumination by low intensity (0.1 mW/cm<sup>2</sup>) ambient light. Figure 53 shows that  $I_B$  increases with increasing wavelength and intensity of incident light;  $I_B$  can reach levels as high as 4500 pA at a light intensity of 3 mW/cm<sup>2</sup> and a wavelength of 850 nm. The light intensities shown in Figure 53 are not normal for most applications, that is, even though direct sunlight can have intensities of 50 mW/cm<sup>2</sup>, office ambient light can be as low as 0.1 mW/cm<sup>2</sup>.

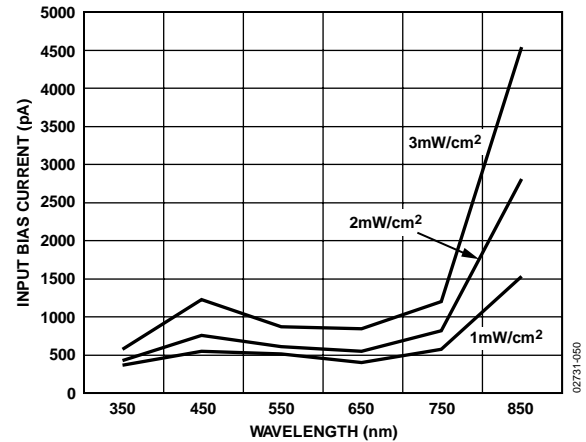

Figure 53. AD8605ACB Input Bias Current Response to Direct Illumination of Varying Intensity and Wavelength

When the WLCSP package is assembled on the board with the bump side of the die facing the PCB, reflected light from the PCB surface is incident on active silicon circuit areas and results in the increased  $I_B$ . No performance degradation occurs due to illumination of the backside (substrate) of the AD8605ACB. The AD8605ACB is particularly sensitive to incident light with wavelengths in the near infrared range (NIR, 700 nm to 1000 nm). Photons in this waveband have a longer wavelength and lower energy than photons in the visible (400 nm to 700 nm) and near ultraviolet (NUV, 200 nm to 400 nm) bands; therefore, they can penetrate more deeply into the active silicon. Incident light with wavelengths greater than 1100 nm has no photoelectric effect on the AD8605ACB because silicon is transparent to wavelengths in this range. The spectral content of conventional light sources varies. Sunlight has a broad spectral range, with peak intensity in the visible band that falls off in the NUV and NIR bands; fluorescent lamps have significant peaks in the visible but not the NUV or NIR bands.

Efforts have been made at a product level to reduce the effect of ambient light; the under bump metal (UBM) has been designed to shield the sensitive circuit areas on the active side (bump side) of the die. However, if an application encounters any light sensitivity with the AD8605ACB, shielding the bump side of the WLCSP package with opaque material should eliminate this effect. Shielding can be accomplished using materials such as silica-filled liquid epoxies that are used in flip-chip underfill techniques.

## WLCSP ASSEMBLY CONSIDERATIONS

For detailed information on the WLCSP PCB assembly and reliability, see Application Note AN-617, *MicroCSP™ Wafer Level Chip Scale Package*.

## I-V CONVERSION APPLICATIONS

### PHOTODIODE PREAMPLIFIER APPLICATIONS

The low offset voltage and input current of the AD8605 make it an excellent choice for photodiode applications. In addition, the low voltage and current noise make the amplifier ideal for application circuits with high sensitivity.

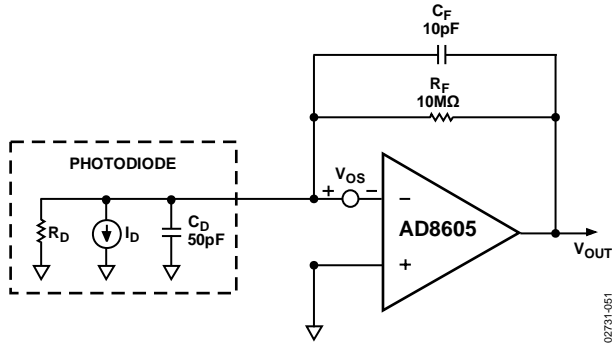

Figure 54. Equivalent Circuit for Photodiode Preamp

The input bias current of the amplifier contributes an error term that is proportional to the value of  $R_F$ .

The offset voltage causes a dark current induced by the shunt resistance of the Diode  $R_D$ . These error terms are combined at the output of the amplifier. The error voltage is written as

$$E_O = V_{OS} \left( 1 + \frac{R_F}{R_D} \right) + R_F I_B$$

Typically,  $R_F$  is smaller than  $R_D$ , thus  $R_F/R_D$  can be ignored.

At room temperature, the AD8605 has an input bias current of 0.2 pA and an offset voltage of 100  $\mu$ V. Typical values of  $R_D$  are in the range of 1 G $\Omega$ .

For the circuit shown in Figure 54, the output error voltage is approximately 100  $\mu$ V at room temperature, increasing to about 1 mV at 85°C.

The maximum achievable signal bandwidth is

$$f_{MAX} = \sqrt{\frac{f_t}{2\pi R_F C_F}}$$

where  $f_t$  is the unity gain frequency of the amplifier.

### AUDIO AND PDA APPLICATIONS

The low distortion and wide dynamic range of the AD860x make it a great choice for audio and PDA applications, including microphone amplification and line output buffering.

Figure 55 shows a typical application circuit for headphone/line-out amplification.

$R_1$  and  $R_2$  are used to bias the input voltage at half the supply, which maximizes the signal bandwidth range.  $C_1$  and  $C_2$  are used to ac couple the input signal.  $C_1$ ,  $R_1$ , and  $R_2$  form a high-pass filter whose corner frequency is  $1/[2\pi(R_1||R_2)C_1]$ .

The high output current of the AD8606 allows it to drive heavy resistive loads.

The circuit in Figure 55 is tested to drive a 16  $\Omega$  headphone. The THD + N is maintained at approximately -60 dB throughout the audio range.

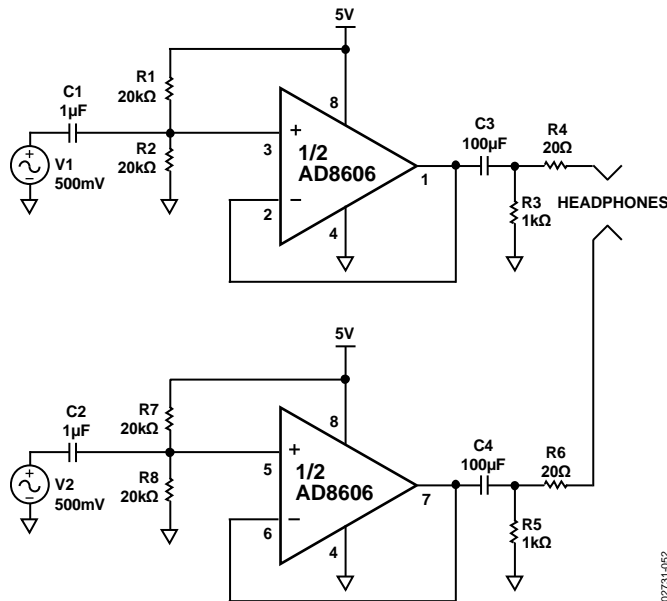

Figure 55. Single-Supply Headphone/Speaker Amplifier

**INSTRUMENTATION AMPLIFIERS**

The low offset voltage and low noise of the AD8605 make it an ideal amplifier for instrumentation applications.

Difference amplifiers are widely used in high accuracy circuits to improve the common-mode rejection ratio. Figure 56 shows a simple difference amplifier. Figure 57 shows the common-mode rejection for a unity gain configuration and for a gain of 10.

Making  $(R4/R3) = (R2/R1)$  and choosing 0.01% tolerance yields a CMRR of 74 dB and minimizes the gain error at the output.

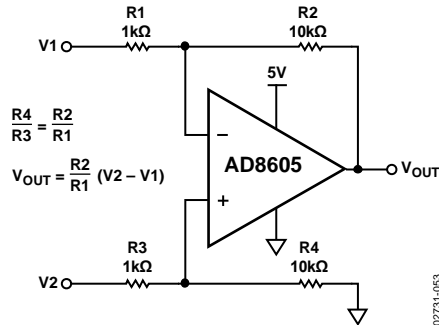

Figure 56. Difference Amplifier,  $A_v = 10$

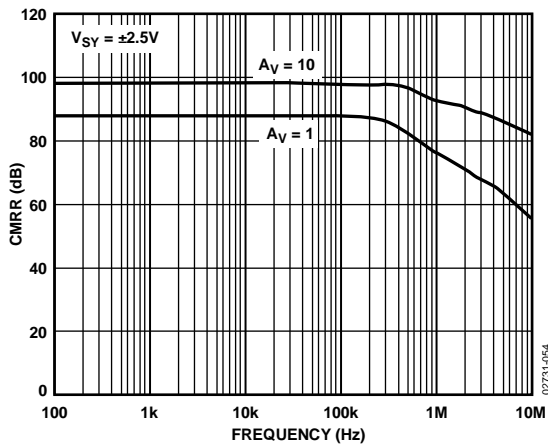

Figure 57. Difference Amplifier CMRR vs. Frequency

**DAC CONVERSION**

The low input bias current and offset voltage of the AD8605 make it an excellent choice for buffering the output of a current output DAC.

Figure 58 shows a typical implementation of the AD8605 at the output of a 12-bit DAC.

The DAC8143 output current is converted to a voltage by the feedback resistor. The equivalent resistance at the output of the DAC varies with the input code, as does the output capacitance.

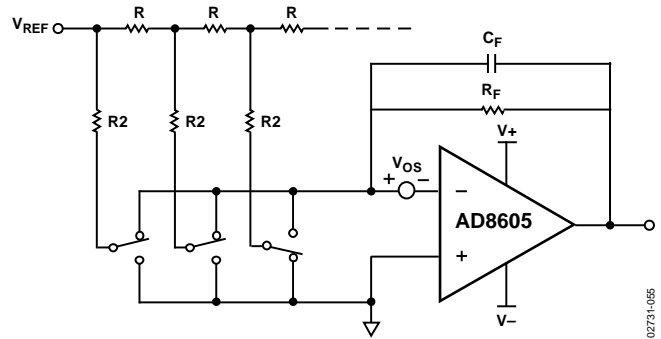

Figure 58. Simplified Circuit of the DAC8143 with AD8605 Output Buffer

To optimize the performance of the DAC, insert a capacitor in the feedback loop of the AD8605 to compensate the amplifier for the pole introduced by the output capacitance of the DAC. Typical values for  $C_F$  range from 10 pF to 30 pF; it can be adjusted for the best frequency response. The total error at the output of the op amp can be computed by

$$E_o = V_{os} \left( 1 + \frac{R_F}{Req} \right)$$

where  $Req$  is the equivalent resistance seen at the output of the DAC. As previously mentioned,  $Req$  is code dependent and varies with the input. A typical value for  $Req$  is 15 kΩ. Choosing a feedback resistor of 10 kΩ yields an error of less than 200 μV.

Figure 59 shows the implementation of a dual-stage buffer at the output of a DAC. The first stage is used as a buffer. Capacitor C1 with  $Req$  creates a low-pass filter, and thus, provides phase lead to compensate for frequency response. The second stage of the AD8606 is used to provide voltage gain at the output of the buffer.

Grounding the positive input terminals in both stages reduces errors due to the common-mode output voltage. Choosing R1, R2, and R3 to match within 0.01% yields a CMRR of 74 dB and maintains minimum gain error in the circuit.

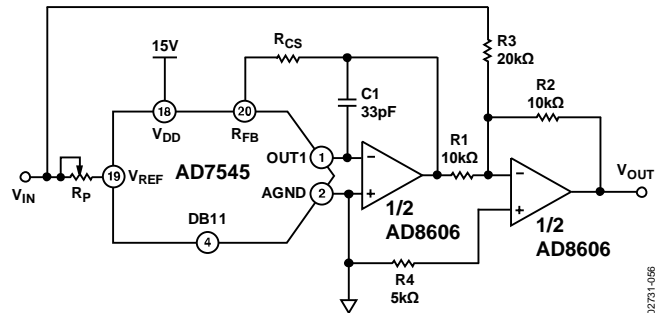

Figure 59. Bipolar Operation

OUTLINE DIMENSIONS

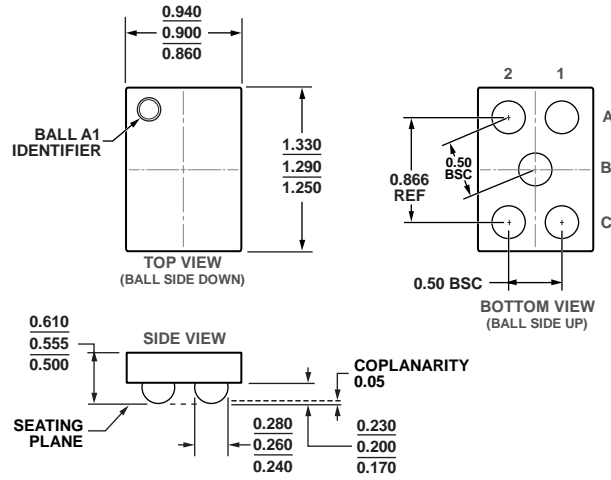
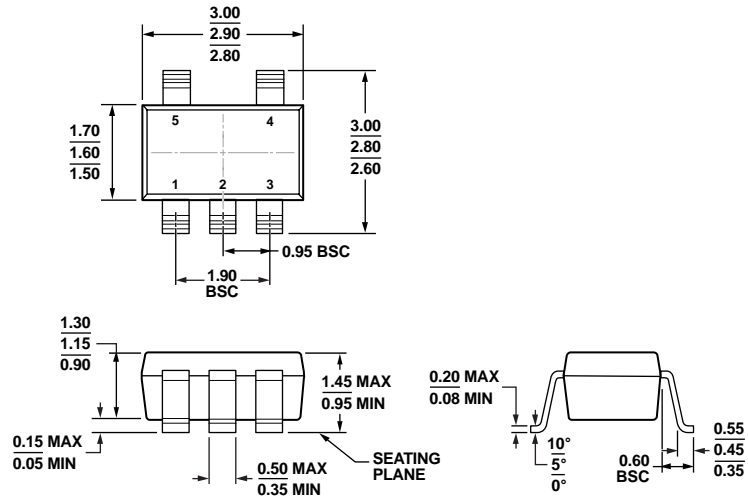

Figure 60. 5-Ball Wafer Level Chip Scale Package [WLCSP] (CB-5-1)  
Dimensions shown in millimeters

02-15-2013-B



COMPLIANT TO JEDEC STANDARDS MO-178-AA  
Figure 61. 5-Lead Small Outline Transistor Package [SOT-23] (RJ-5)  
Dimensions shown in millimeters

11-01-2010-A

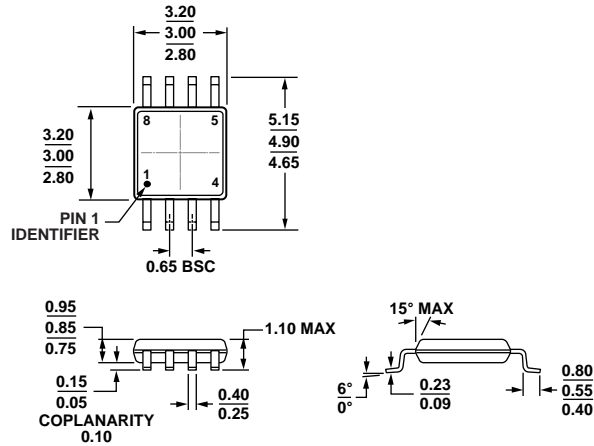

COMPLIANT TO JEDEC STANDARDS MO-187-AA

Figure 62. 8-Lead Mini Small Outline Package [MSOP] (RM-8)

Dimensions shown in millimeters

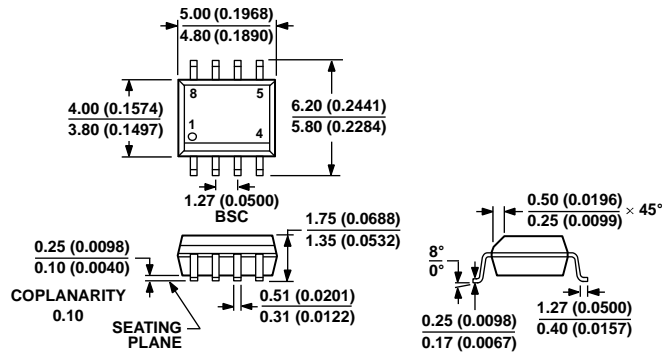

COMPLIANT TO JEDEC STANDARDS MS-012-AA

CONTROLLING DIMENSIONS ARE IN MILLIMETERS; INCH DIMENSIONS (IN PARENTHESES) ARE ROUNDED-OFF MILLIMETER EQUIVALENTS FOR REFERENCE ONLY AND ARE NOT APPROPRIATE FOR USE IN DESIGN.

Figure 63. 8-Lead Standard Small Outline Package [SOIC\_N] Narrow Body (R-8)

Dimensions shown in millimeters and (inches)

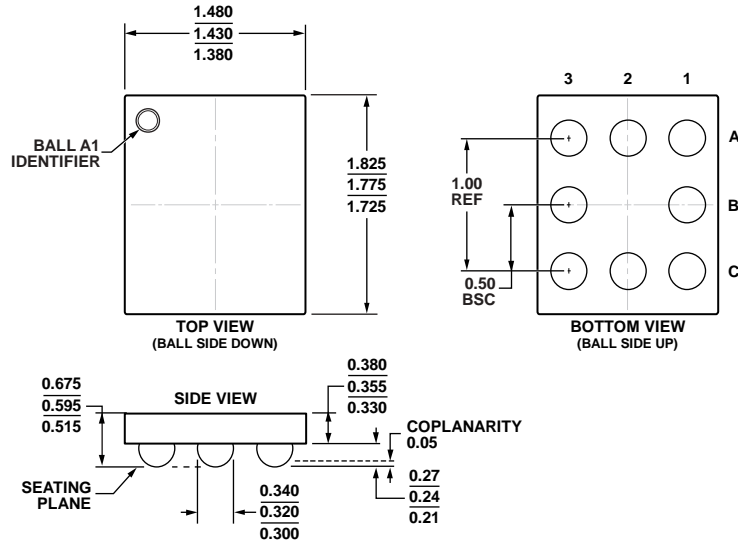
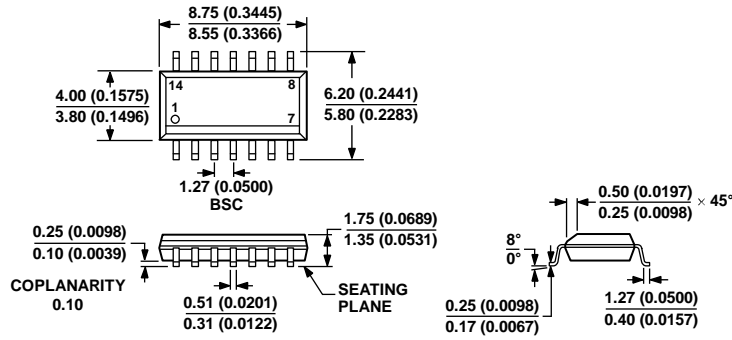

Figure 64. 8-Ball Wafer Level Chip Scale Package [WLCSPP]  
(CB-8-1)  
Dimensions shown in millimeters

08-10-2012-A



COMPLIANT TO JEDEC STANDARDS MS-012-AB  
CONTROLLING DIMENSIONS ARE IN MILLIMETERS; INCH DIMENSIONS  
(IN PARENTHESES) ARE ROUNDED-OFF MILLIMETER EQUIVALENTS FOR  
REFERENCE ONLY AND ARE NOT APPROPRIATE FOR USE IN DESIGN.

Figure 65. 14-Lead Standard Small Outline Package [SOIC\_N]  
Narrow Body (R-14)  
Dimensions shown in millimeters and (inches)

060606-A

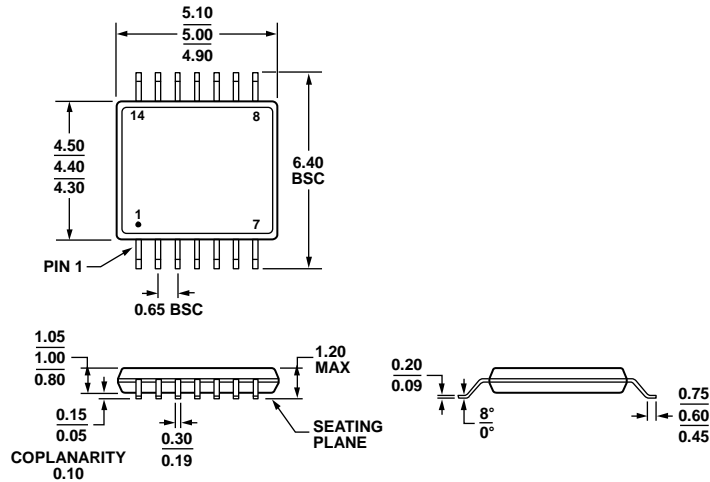

COMPLIANT TO JEDEC STANDARDS MO-153-AB-1

Figure 66. 14-Lead Thin Shrink Small Outline Package [TSSOP] (RU-14)

Dimensions shown in millimeters and (inches)

061908-A

**ORDERING GUIDE**

Model <sup>1</sup>	Temperature Range	Package Description	Package Option	Marking Code
AD8605ACBZ-REEL7	-40°C to +125°C	5-Ball WLCSP	CB-5-1	A1J
AD8605ARTZ-R2	-40°C to +125°C	5-Lead SOT-23	RJ-5	B3A#
AD8605ARTZ-REEL	-40°C to +125°C	5-Lead SOT-23	RJ-5	B3A#
AD8605ARTZ-REEL7	-40°C to +125°C	5-Lead SOT-23	RJ-5	B3A#
AD8606ARM-REEL	-40°C to +125°C	8-Lead MSOP	RM-8	B6A
AD8606ARMZ-R7	-40°C to +125°C	8-Lead MSOP	RM-8	B6A#
AD8606ARMZ-REEL	-40°C to +125°C	8-Lead MSOP	RM-8	B6A#
AD8606ARZ	-40°C to +125°C	8-Lead SOIC_N	R-8	
AD8606ARZ-REEL	-40°C to +125°C	8-Lead SOIC_N	R-8	
AD8606ARZ-REEL7	-40°C to +125°C	8-Lead SOIC_N	R-8	
AD8606ACBZ-REEL7	-40°C to +125°C	8-Ball WLCSP	CB-8-1	B6A#
AD8608ARZ	-40°C to +125°C	14-Lead SOIC_N	R-14	
AD8608ARZ-REEL	-40°C to +125°C	14-Lead SOIC_N	R-14	
AD8608ARZ-REEL7	-40°C to +125°C	14-Lead SOIC_N	R-14	
AD8608ARUZ	-40°C to +125°C	14-Lead TSSOP	RU-14	
AD8608ARUZ-REEL	-40°C to +125°C	14-Lead TSSOP	RU-14	

<sup>1</sup> Z = RoHS Compliant Part, # denotes RoHS compliant product (except for CB-5-1) may be top or bottom marked.



# Mouser Electronics

Authorized Distributor

Click to View Pricing, Inventory, Delivery & Lifecycle Information:

## [Analog Devices Inc.:](#)

[AD8606ARZ-REEL7](#) [AD8605ART-REEL](#) [AD8605ACBZ-REEL7](#) [AD8605ARTZ-REEL](#) [AD8606AR-REEL](#)  
[AD8606ARZ-REEL](#) [AD8608ARZ](#) [AD8608ARUZ](#) [AD8606ACBZ-REEL7](#) [AD8605ARTZ-R2](#) [AD8605ARTZ-REEL7](#)  
[AD8606ARM-REEL](#) [AD8606ARMZ-REEL](#) [AD8606AR](#) [AD8608ARUZ-REEL](#) [AD8608ARZ-REEL](#) [AD8606AR-REEL7](#)  
[AD8606ARMZ-R7](#) [AD8605ACBZ-REEL](#) [AD8606ARZ](#) [AD8608ARZ-REEL7](#)