



MAB 7 S

Industrial Connectors:Connectors for audio, video and data:Miniature multipole connectors:without locking screw:Panel-mounted sockets

Product description

Type	MAB 7 S
Order No.	930 343-200
Type of contact	female
Description	panel-mounted socket with flange; solder joint
Number of contacts	7
Conductor size	$\leq 0.34 \text{ mm}^2$

Drawing

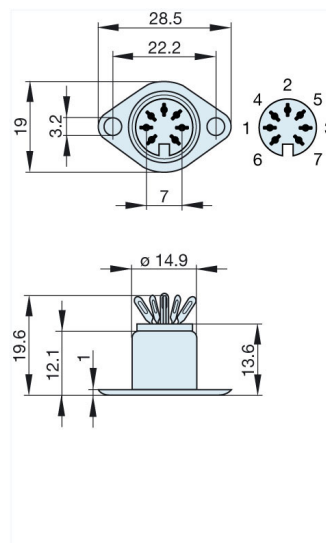

Technical data

LF output "Phone"	EN 60 130-09
Pole arrangement DIN	DIN 45 329
Rated current	$\leq 4 \text{ A}$
Rated voltage	UC 34 V
Type of termination	solder

Material

Contact material (socket)	brass
Contact surface material	tin plated
Contact bearer material	PA 66/UL standard 94V-2
Housing material	steel, nickel-plated

Environmental conditions

Protection class (IEC 60529)	IP 30
Temperature range	$-20 \text{ }^\circ\text{C}$ to $+60 \text{ }^\circ\text{C}$