

Specifications

- Current rating:1A AC,DC
- Voltage rating:125V AC,DC
- Temperature range:-40°C~+105°C
- Contact resistance:20mΩMax.
- Insulation resistance:100MΩMin.
- Withstanding voltage:500V AC/minute
- *Compliant with RoHS and REACH*
- *Meet the HF/Halogen Free,need to customize*
- *Contact CJT for details*

Standards



Assembly layout

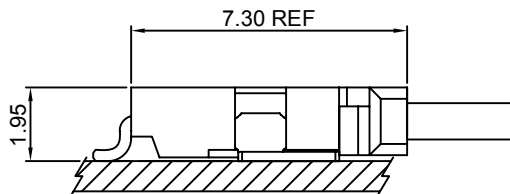



A1254 SERIES

1.25mm pitch wire to board connector

A1254-T

1.25mm pitch Crimp Terminal

Reference Informations:

*Used in CJT A1254H-XP series Housing

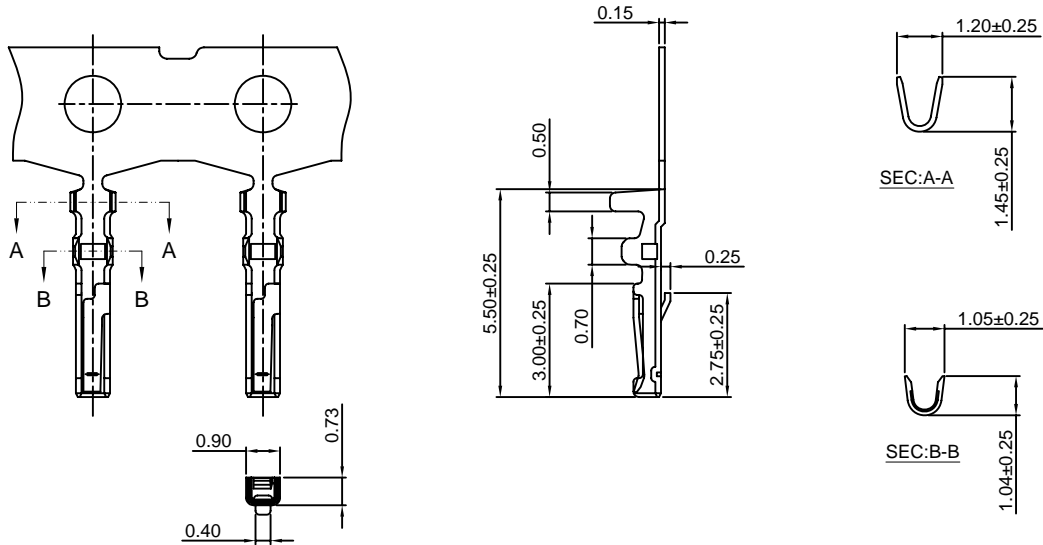

Ordering information & Specifications:

Unit:mm

| Part NO. | Wire Range | Insulation O.D. | Material | Finish | Qty/reel |
|----------|------------|-----------------|-----------------|------------------|------------|
| A1254-TP | AWG#28-#32 | 0.90mm(max) | Phosphor Bronze | Tin over Nickel | 10,000 PCS |
| A1254-GP | AWG#28-#32 | 0.90mm(max) | Phosphor Bronze | Gold over Nickel | 10,000 PCS |

Optional Gold plating available but MOQ requested

A1254H-XP

1.25mm pitch Housing

Reference Informations:

*Material:Nylon 66,UL94V-0

*Suitable CJT A1254-T series Terminal

*Mates with CJT A1254WR-S-XP series Wafer

*Color:White

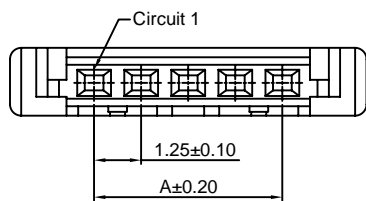

Ordering Information:

A1254H-XP - ***
1 2

1.Part No.

2.Material:

(Blank):Nylon 66,UL94V-0

GWT :Nylon 66,UL94V-0 GWT 750°C

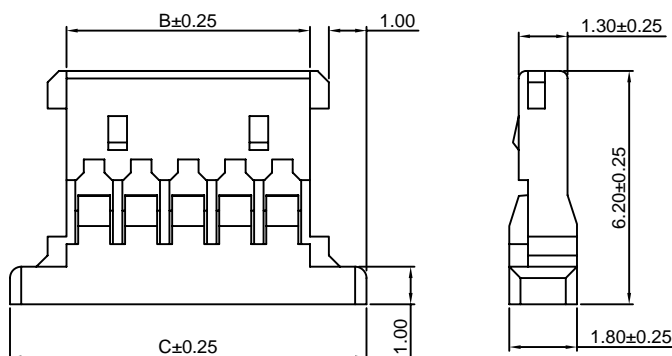
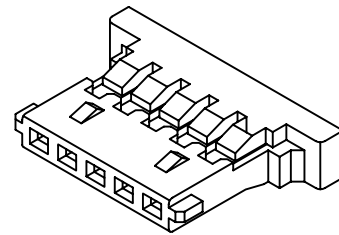

Ordering Information & Dimensions:

| PART NO. | Dimensions | | | PART NO. | Dimensions | | |
|----------|------------|-------|-------|----------|------------|-------|-------|
| | A | B | C | | A | B | C |
| 2P | 1.25 | 2.72 | 5.72 | 17P | 20.00 | 21.47 | 24.47 |
| 3P | 2.50 | 3.97 | 6.97 | 18P | 21.25 | 22.72 | 25.72 |
| 4P | 3.75 | 5.22 | 8.22 | 19P | 22.50 | 23.97 | 26.97 |
| 5P | 5.00 | 6.47 | 9.47 | 20P | 23.75 | 25.22 | 28.22 |
| 6P | 6.25 | 7.72 | 10.72 | 21P | 25.00 | 26.47 | 29.47 |
| 7P | 7.50 | 8.97 | 11.97 | 22P | 26.25 | 27.72 | 30.72 |
| 8P | 8.75 | 10.22 | 13.22 | 23P | 27.50 | 28.97 | 31.97 |
| 9P | 10.00 | 11.47 | 14.47 | 24P | 28.75 | 30.22 | 33.22 |
| 10P | 11.25 | 12.72 | 15.72 | 25P | 30.00 | 31.47 | 34.47 |
| 11P | 12.50 | 13.97 | 16.97 | 26P | 31.25 | 32.72 | 35.72 |
| 12P | 13.75 | 15.22 | 18.22 | 27P | 32.50 | 33.97 | 36.97 |
| 13P | 15.00 | 16.47 | 19.47 | 28P | 33.75 | 35.22 | 38.22 |
| 14P | 16.25 | 17.72 | 20.72 | 29P | 35.00 | 36.47 | 39.47 |
| 15P | 17.50 | 18.97 | 21.97 | 30P | 36.25 | 37.72 | 40.72 |
| 16P | 18.75 | 20.22 | 23.22 | | | | |

Unit: mm



A1254 SERIES

1.25mm pitch wire to board connector

A1254HA-XP

1.25mm pitch Housing

Reference Informations:

- *Material:Nylon 66,UL94V-0
- *Suitable CJT A1254-T series Terminal
- *Color:White

Ordering Information:
 A1254HA-XP - ***
 1 2
 1.Part No.
 2.Material:
 (Blank):Nylon 66,UL94V-0
 GWT :Nylon 66,UL94V-0 GWT 750 °C

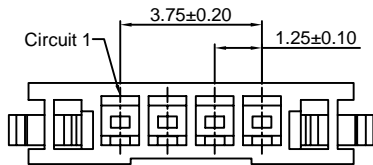
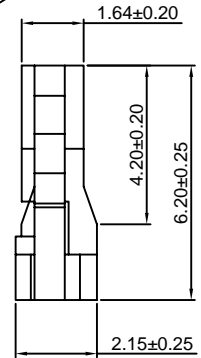
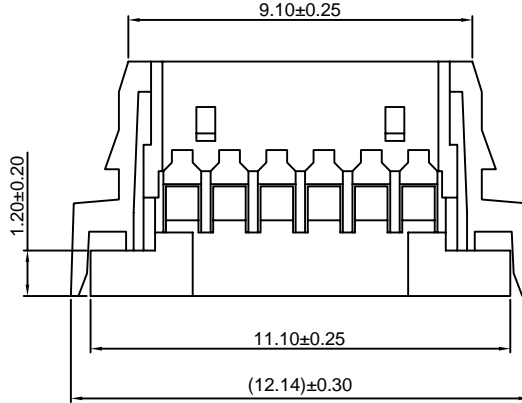
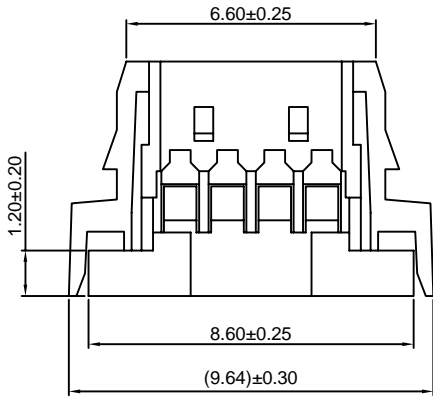
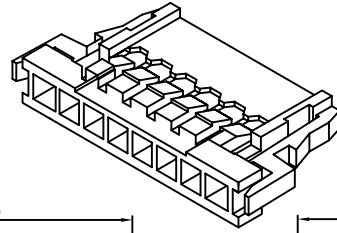

A1254HA-4P

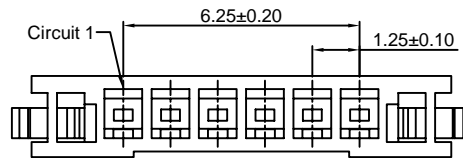

A1254HA-6P

Unit: mm

A1254WR-S-XP

1.25mm pitch 90° Wafer-SMT TYPE

Reference Informations:

- *Material:Pin:Brass/Tin over Nickel on solder area
Gold over Nickel on contact area
Solder Tabs:Brass/Tin over Nickel
Insulator:Nylon 6T,UL94V-0
- *Mates with CJT A1254H-XP series Housing
- *Color:Beige

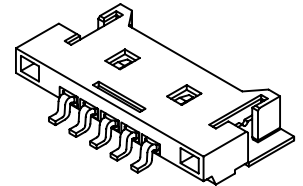
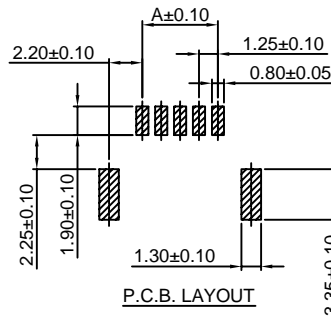

Ordering Information:
 A1254WR-S-XP - ***
 1 2
 1.Part No.
 2.Material:
 (Blank):Nylon 6T,UL94V-0
 GWT :Nylon 6T,UL94V-0 GWT 750 °C

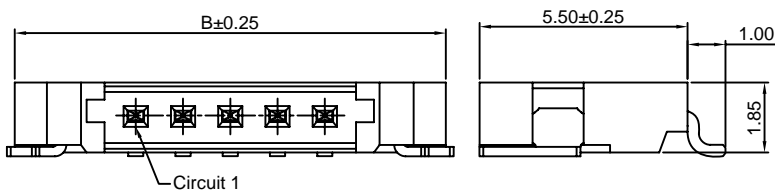
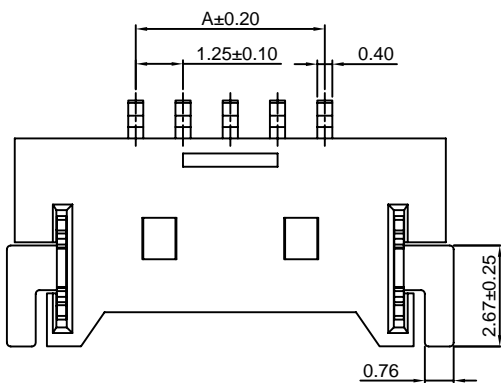

Ordering Information & Dimensions:

| PART NO. | Dimensions | | PART NO. | Dimensions | |
|----------|------------|-------|----------|------------|-------|
| | A | B | | A | B |
| 2P | 1.25 | 7.65 | 17P | 20.00 | 26.40 |
| 3P | 2.50 | 8.90 | 18P | 21.25 | 27.65 |
| 4P | 3.75 | 10.15 | 19P | 22.50 | 28.90 |
| 5P | 5.00 | 11.40 | 20P | 23.75 | 30.15 |
| 6P | 6.25 | 12.65 | 21P | 25.00 | 31.40 |
| 7P | 7.50 | 13.90 | 22P | 26.25 | 32.65 |
| 8P | 8.75 | 15.15 | 23P | 27.50 | 33.90 |
| 9P | 10.00 | 16.40 | 24P | 28.75 | 35.15 |
| 10P | 11.25 | 17.65 | 25P | 30.00 | 36.40 |
| 11P | 12.50 | 18.90 | 26P | 31.25 | 37.65 |
| 12P | 13.75 | 20.15 | 27P | 32.50 | 38.90 |
| 13P | 15.00 | 21.40 | 28P | 33.75 | 40.15 |
| 14P | 16.25 | 22.65 | 29P | 35.00 | 41.40 |
| 15P | 17.50 | 23.90 | 30P | 36.25 | 42.65 |
| 16P | 18.75 | 25.15 | | | |

Unit: mm