

## Specifications

- Current rating:1A AC,DC
- Voltage rating:200V AC,DC
- Temperature range:-40°C~+105°C
- Contact resistance:20mΩMax.
- Insulation resistance:100MΩMin.
- Withstanding voltage:500V AC/minute
- \*Compliant with RoHS and REACH\*
- \*Meet the HF/Halogen Free,need to customize\*
- \*Contact CJT for details\*

## Standards

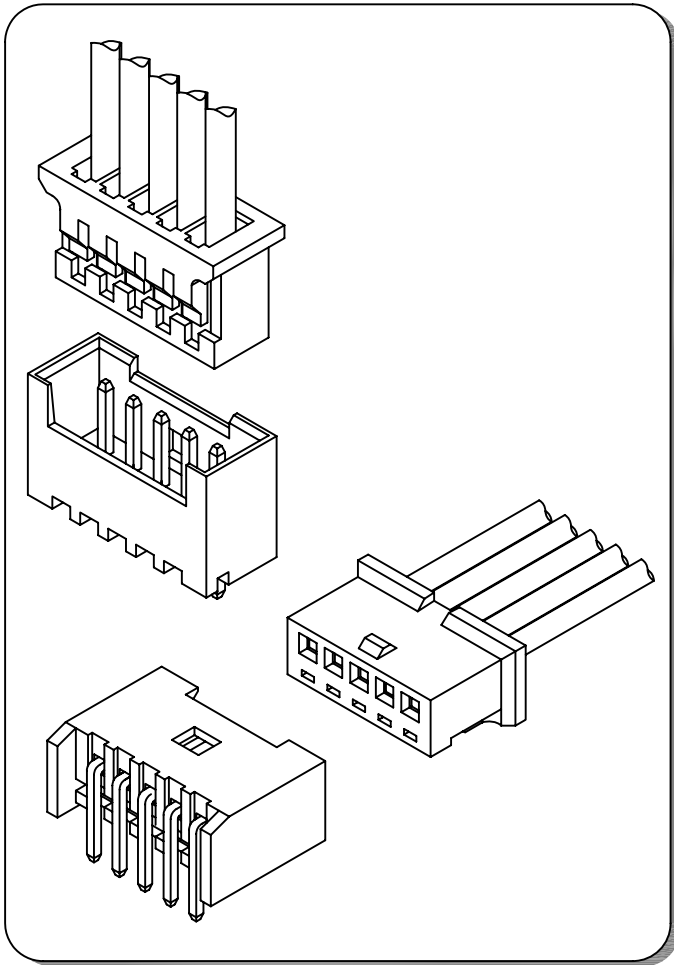

## Assembly layout

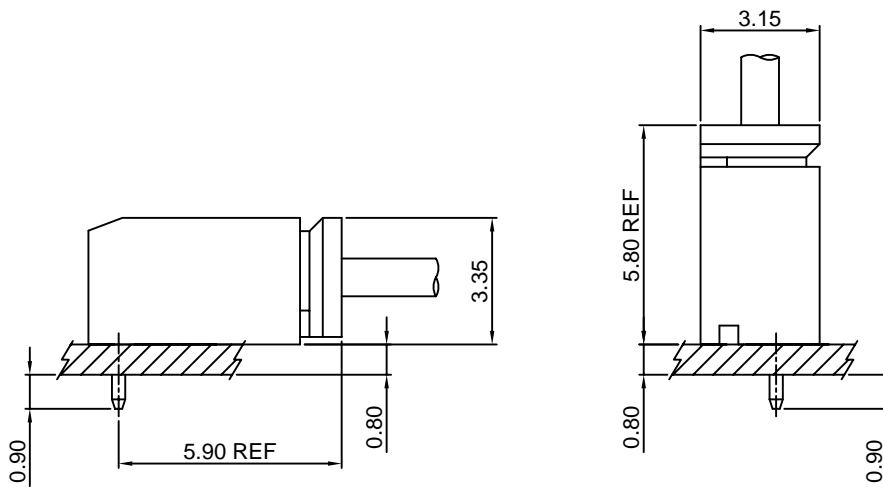



# A1253 SERIES

1.25mm pitch wire to board connector

## A1253-T

1.25mm pitch Crimp Terminal

**Reference Informations:**

\*Used in CJT A1253H-XP series Housing

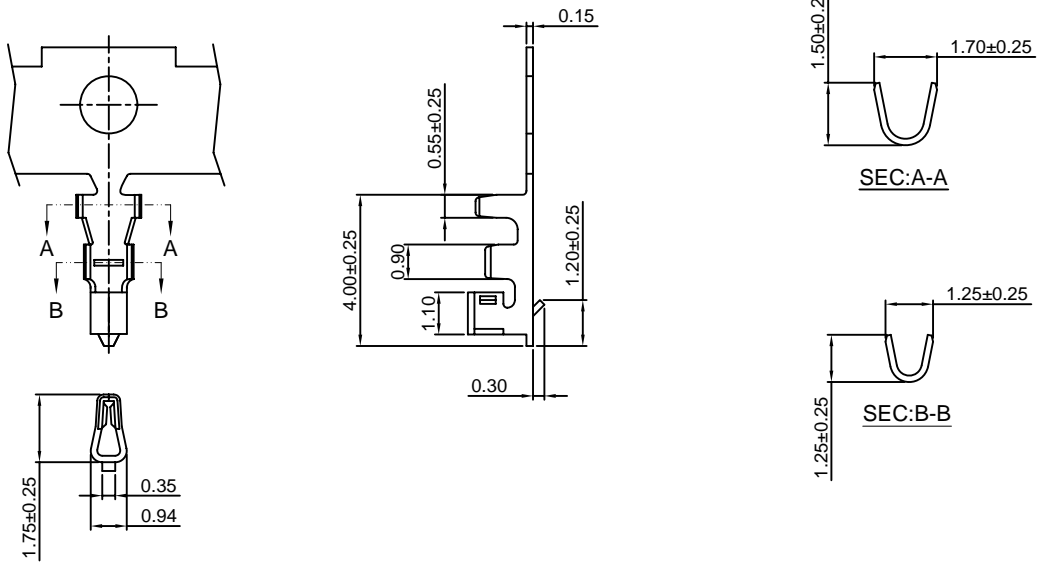

Ordering information & Specifications:

Unit:mm

| Part NO. | Wire Range | Insulation O.D. | Material        | Finish           | Qty/reel   |
|----------|------------|-----------------|-----------------|------------------|------------|
| A1253-TP | AWG#28-#32 | 1.00mm(max)     | Phosphor Bronze | Tin over Nickel  | 10,000 PCS |
| A1253-GP | AWG#28-#32 | 1.00mm(max)     | Phosphor Bronze | Gold over Nickel | 10,000 PCS |

Optional Gold plating available but MOQ requested

## A1253H-XP

1.25mm pitch Housing

**Reference Informations:**

\*Material:Nylon 66,UL94V-0

\*Suitable CJT A1253-T series Terminal

\*Mates with CJT A1253WV,A1253WR-XP series Wafer

\*Color:Reddish brown

Ordering Information:

A1253H-XP - \*\*  
1 2

1.Part No.

2.Material:

(Blank):Nylon 66,UL94V-0

GWT :Nylon 66,UL94V-0 GWT 750 °C

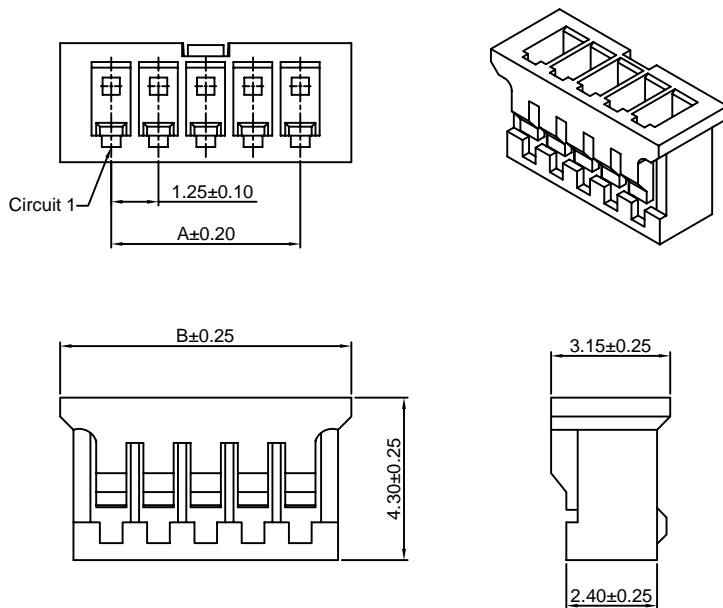

Ordering Information & Dimensions:

| PART NO. | Dimensions |       |
|----------|------------|-------|
|          | A          | B     |
| 2P       | 1.25       | 3.95  |
| 3P       | 2.50       | 5.20  |
| 4P       | 3.75       | 6.45  |
| 5P       | 5.00       | 7.70  |
| 6P       | 6.25       | 8.95  |
| 7P       | 7.50       | 10.20 |
| 8P       | 8.75       | 11.45 |
| 9P       | 10.00      | 12.70 |
| 10P      | 11.25      | 13.95 |
| 11P      | 12.50      | 15.20 |
| 12P      | 13.75      | 16.45 |
| 13P      | 15.00      | 17.70 |
| 14P      | 16.25      | 18.95 |
| 15P      | 17.50      | 20.20 |

Unit: mm



# A1253 SERIES

1.25mm pitch wire to board connector

## A1253WV-XP

1.25mm pitch 180° Wafer

**Reference Informations:**

- \*Material:Pin:Brass/Tin over Nickel  
Insulator:Nylon 66,UL94V-0
- \*Mates with CJT A1253H-XP series Housing
- \*Color:Reddish brown

**Ordering Information:**

- A1253WV-XP - \*\*\* - \*\*  
 1            2            3
- 1.Part No.
  - 2.Material:  
(Blank):Nylon 66,UL94V-0  
GWT:Nylon 66,UL94V-0,GWT 750°C
  - 3.Finish:  
(Blank):Tin over Nickel  
G:Gold over Nickel

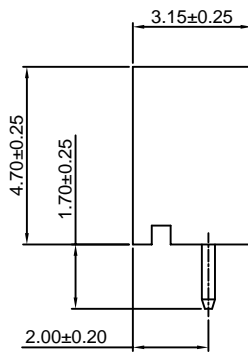
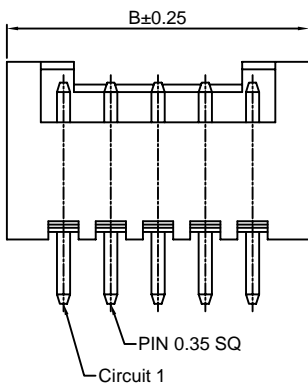
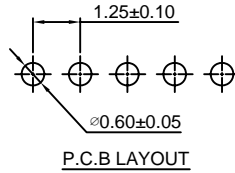
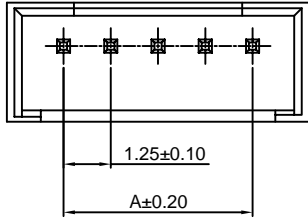
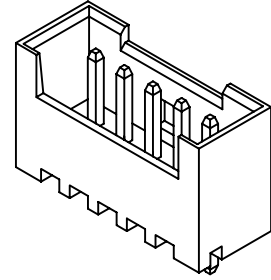

**Ordering Information & Dimensions:**

| PART NO. | Dimensions |       |
|----------|------------|-------|
|          | A          | B     |
| 2P       | 1.25       | 4.25  |
| 3P       | 2.50       | 5.50  |
| 4P       | 3.75       | 6.75  |
| 5P       | 5.00       | 8.00  |
| 6P       | 6.25       | 9.25  |
| 7P       | 7.50       | 10.50 |
| 8P       | 8.75       | 11.75 |
| 9P       | 10.00      | 13.00 |
| 10P      | 11.25      | 14.25 |
| 11P      | 12.50      | 15.50 |
| 12P      | 13.75      | 16.75 |
| 13P      | 15.00      | 18.00 |
| 14P      | 16.25      | 19.25 |
| 15P      | 17.50      | 20.50 |

Unit: mm

## A1253WR-XP

1.25mm pitch 90° Wafer

**Reference Informations:**

- \*Material:Pin:Brass/Tin over Nickel  
Insulator:Nylon 66,UL94V-0
- \*Mates with CJT A1253H-XP series Housing
- \*Color:Reddish brown

**Ordering Information:**

- A1253WR-XP - \*\*\* - \*\*  
 1            2            3
- 1.Part No.
  - 2.Material:  
(Blank):Nylon 66,UL94V-0  
GWT :Nylon 66,UL94V-0,GWT 750°C
  - 3.Finish:  
(Blank):Tin over Nickel  
G:Gold over Nickel

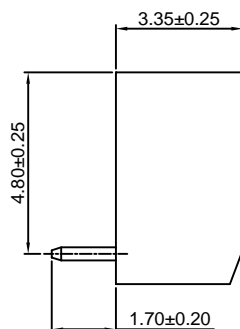
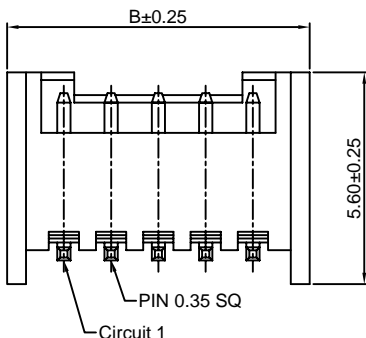
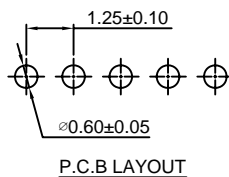
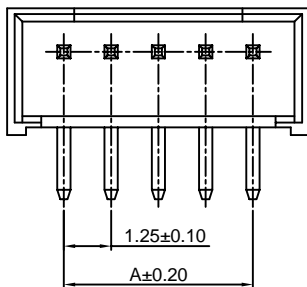
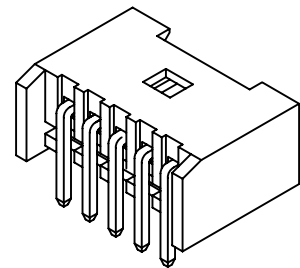

**Ordering Information & Dimensions:**

| PART NO. | Dimensions |       |
|----------|------------|-------|
|          | A          | B     |
| 2P       | 1.25       | 4.25  |
| 3P       | 2.50       | 5.50  |
| 4P       | 3.75       | 6.75  |
| 5P       | 5.00       | 8.00  |
| 6P       | 6.25       | 9.25  |
| 7P       | 7.50       | 10.50 |
| 8P       | 8.75       | 11.75 |
| 9P       | 10.00      | 13.00 |
| 10P      | 11.25      | 14.25 |
| 11P      | 12.50      | 15.50 |
| 12P      | 13.75      | 16.75 |
| 13P      | 15.00      | 18.00 |
| 14P      | 16.25      | 19.25 |
| 15P      | 17.50      | 20.50 |

Unit: mm