

# Installation Guide of Hi-Speed USB to Industrial Single RS-422/485 Adapter

## Introduction of USB-COMi+2

The USB-COMi+2 USB to Industrial Single RS-422/485 Adapter is designed to make serial port expansion quick and simple. Connecting to a USB port on your computer or USB hub, the USB Serial Adapter instantly adds one industrial RS-422/485 multi-electrical interface serial communication port to your system. By taking advantage of the USB bus, the USB Serial Adapter makes it easier than ever to add one RS-422/485 port and serial devices to your system with easy plug and play and hot plug features. Adapting the new technology, the serial port expansion now takes the new bus with easy and convenient connectivity.

Plugging the USB-COMi+2 USB to Industrial Single Serial Adapter to the USB port, the adapter is automatically detected and installed. There are no IRQ & COM port conflicts, since the port doesn't require any additional IRQ, DMA, memory as resources on the system. The RS-422/485 port functions as native Windows COM port, and it is compatible with Windows serial communication applications. The adapter is designed with external switches to set RS-232, RS-422 or RS-485 ports and different operation modes conveniently. The upper case can be sliding open easily for configuration and mode setting.

The USB Serial Adapter provides instant connectivity to RS-422/485 communication devices for factory automation equipment, multi-drop data collection devices, barcode readers, time clocks, scales, data entry terminals, ATMs and serial communication in harsh environment. The USB to Serial Adapter is suitable for remote access, retail and industrial application, data collection and other applications requiring high speed RS-422/485 communication ports.

## Specifications & Features

- Adds one high speed RS-422 / 485 serial port via USB connection.
- 384 byte receive buffer.
- 128 byte transmit buffer for high speed data throughput.
- Requires no IRQ, DMA, I/O port.
- Data rates: 300 bps to 921.6K bps.
- Serial Connector: one DB-9 male connector.
- Auto transmit buffer control for 2-wire RS-485 half-duplex operation.
- Termination resistors installed on-board.
- RS-422 data signals: Tx-, Tx+, Rx+, Rx-, GND, RTS-, RTS+, CTS+, CTS-.
- RS-485 data signals: Tx-, Tx+, Rx+, Rx-(4 wire) and data-, data+ (2 wire).
- Monitor LEDs of TxD, RxD indicating port status.
- No external power adapter required
- Easy operation mode configuration and setting
- Virtual COM port drivers available for Windows 7, Vista, 2003, XP, 2000.

## Hardware Installation

Inside the unit, there is one 3-pin DIP switch which is set to select the mode of operation. You will need to push down the upper case, and slide it open by following the direction of the red arrow in the illustration below. You can set the switch settings to RS-422 or RS-485 mode as per the requirements of your application.

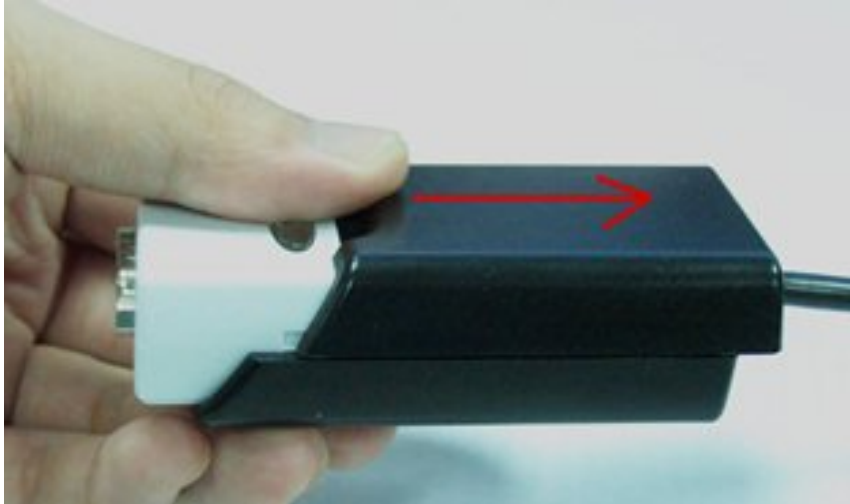

**Push down the upper case and slide it to open**

You need to install driver first, prior to hardware installation. After the setting of DIP switch and connecting USB cable to the adapter to start driver installation.

The Mode Block Configuration Settings are listed as follows:

### RS-422 & RS-485 Mode Block Configuration SW (External DIP Switch) for Mode Setting

	Operation Mode	S1	S2	S3
RS-422	4 wire with Handshaking	ON	ON	ON
RS-485	Full Duplex (4 wire)	OFF	ON	ON
	Half Duplex (2 wire) - with Echo	OFF	OFF	ON
	Half Duplex (2 wire) - without Echo	OFF	OFF	OFF



### 3-Pin DIP Switch for Operating Mode Selection

### Termination and Biasing Option Configuration

Inside the unit, there is one 3 x 7 (21 pin) header blocks which are jumpered to enable Tx, Rx, CTS 120 Ohm termination resistors and Tx, Rx 750 Ohm BIASing resistor.

You will need to open up the upper case and set the jumper setting for RS-422 mode or RS-485 mode as per the requirements of your application.

Settings are listed as follows:

Jumper	Function
1-2 <b>enable</b>	Tx Termination of 120 Ohm.
2-3 <b>disable</b>	This jumper should always be populated for RS-485 mode.
4-5 <b>enable</b>	Pull-up Tx+ to VCC by 750 Ohm Bias resistor.
5-6 <b>disable</b>	This jumper should be populated for pull-up Tx+.
7-8 <b>enable</b>	Pull-down Tx- to GND by 750 Ohm Bias resistor.
8-9 <b>disable</b>	This jumper should be populated for pull-down Tx- .
10-11 <b>enable</b>	Rx Termination of 120 Ohm.
11-12 <b>disable</b>	This jumper should always be populated for RS-422 mode.
13-14 <b>enable</b>	Pull-up Rx+ to VCC by 750 Ohm Bias resistor.
14-15 <b>disable</b>	This jumper should be populated for pull-up Rx+
16-17 <b>enable</b>	Pull-down Rx- to GND by 750 Ohm Bias resistor.
17-18 <b>disable</b>	This jumper should be populated for pull-down Rx- .
19-20 <b>enable</b>	CTS Termination of 120 Ohm.
20-21 <b>disable</b>	This jumper should always be populated for RS-422 mode.

**Note :** Sometimes, when operating in RS-422 or RS-485, it is necessary to configure termination and biasing of the data transmission lines. Generally this must be done in the cabling, since this depends on the installation of connections. Before

applying the option, check your cable specification for proper impedance matching.

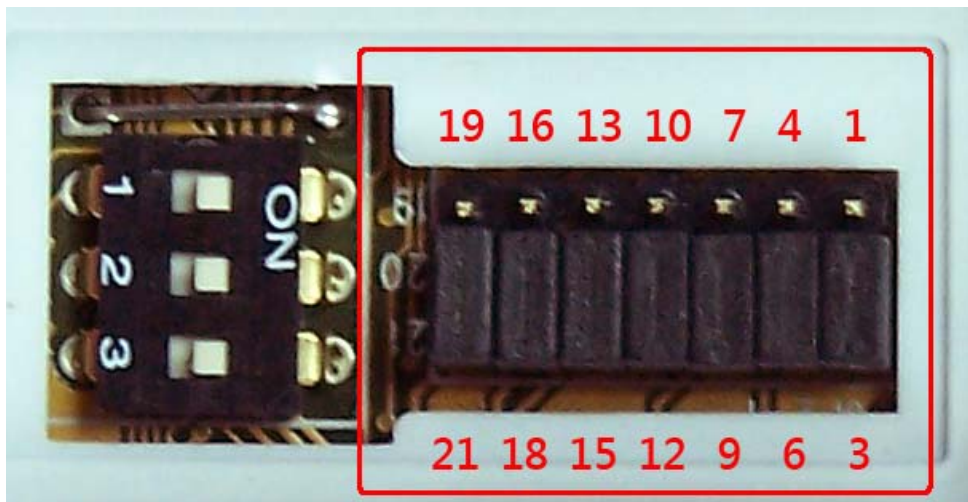

**7 x 3 header block to enable Termination and Biasing resistors**

## Windows 7/ Vista / 2003 / XP / 2000 Driver Installation

You need to have administrator privileges to install any new drivers under Windows 7/ Vista /2003/XP /2000. To install the driver or update the configuration please log onto Windows as "Administrator" or ask your system administrator to install the USB-COM driver.

*You need to install driver first, prior to hardware installation. Do not connect the USB-to-Serial Adapter to the USB port of your computer, before you finish driver installation.*

Please proceed with the following steps to install the driver:

1. Insert the "USB COM Series Driver and Utility" CD into your CD-ROM.
2. The "USB COM Series Driver and Utility CD" dialog box appears.
3. Under "Driver Installation", double click "Windows 7, Vista, 2003, XP, 2000 driver" to install the device driver.
4. The USB COM install program will auto-detect the OS type and install the driver automatically. (Note: in Windows 7 or Vista OS you will find another dialog box, please click on "OK" to confirm the drivers install program).

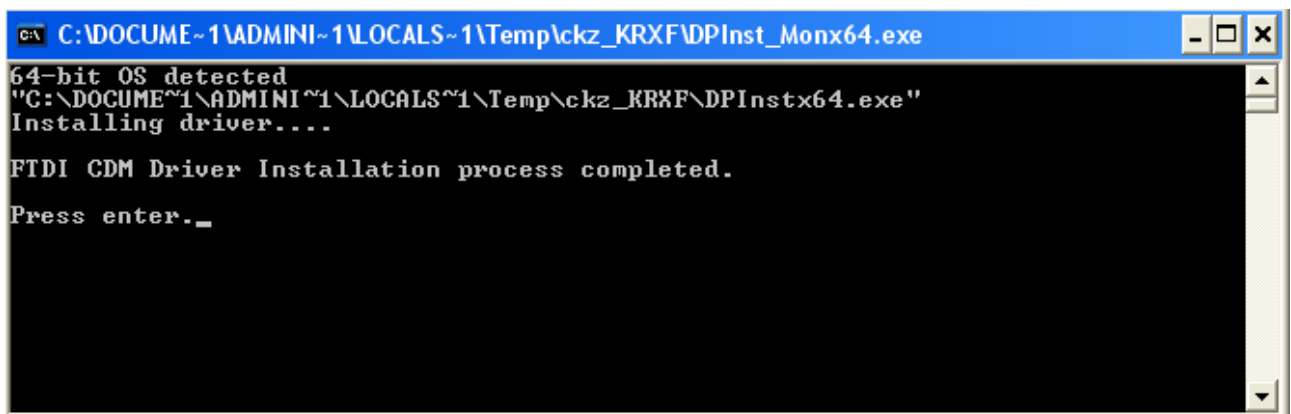

```
C:\DOCUME~1\ADMINI~1\LOCALS~1\Temp\ckz_KRXF\DPInst_Monx64.exe
64-bit OS detected
"C:\DOCUME~1\ADMINI~1\LOCALS~1\Temp\ckz_KRXF\DPInstx64.exe"
Installing driver....
FTDI CDM Driver Installation process completed.
Press enter._
```

5. After the message "FTDI CDM Driver installation process completed" appears, press "Enter" to complete the driver installation.
6. Plug in the USB to Serial Adapter to the USB port of your computer. Windows will finish installing the driver files.

### Check Installation

You can now verify the installation has been completed successfully by looking under Device Manager of the System Properties screen. (Go there by Start-Setting-Control Panel-System Properties-Hardware-Device Manager).

The device should have installed as a "USB Serial Port (COMx)" attached to "USB Serial Converter".

## Change COM Port Properties & COM Port Number

This feature is particularly useful for programs, such as HyperTerminal, which only work with COM1 through COM4. Please ensure that you do not change the COM Port Number already in use.

To change the virtual COM port properties:

- Select the "USB Serial Port"
- Click "Properties".
- Select "Port Setting" and "Advanced".
- Click the drop down arrow on COM Port Number and scroll to the required COM port. Select "OK".
- Return to the Device Manager Screen. You will see that the USB Serial Port installation has been changed to the new COM Port Number.

## Uninstalling Windows 2003/XP/2000 Drivers

Please proceed with the following steps to uninstall the 2003/XP/2000 driver:

1. Insert the "USB COM Series Driver and Utility" CD into your CD-ROM.
2. The "USB COM Series Driver and Utility CD" dialog box appears.
3. Under "Driver Uninstalling", double click "Windows 2003, XP, 2000 driver uninstall" to uninstall the device driver.
4. When following dialog box appears, double click "Clean System" to uninstall the 2003/XP/2000 drivers.

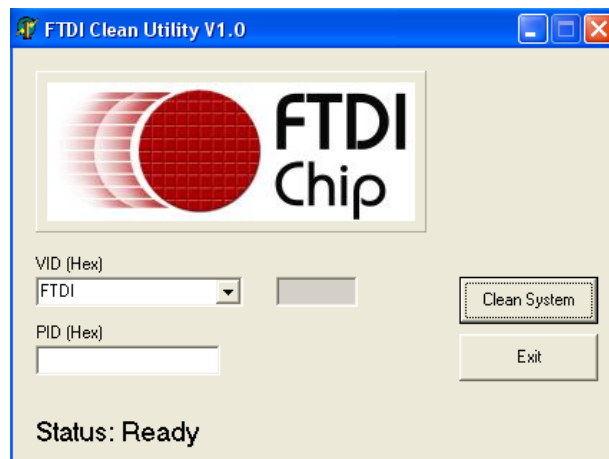

5. You need to disconnect all USB to serial Adapters from your PC, when the message below appears. Double click "OK" to start uninstalling Windows 2003/XP/2000 USB to Serial drivers.



6. Double click “Yes” to confirm it.

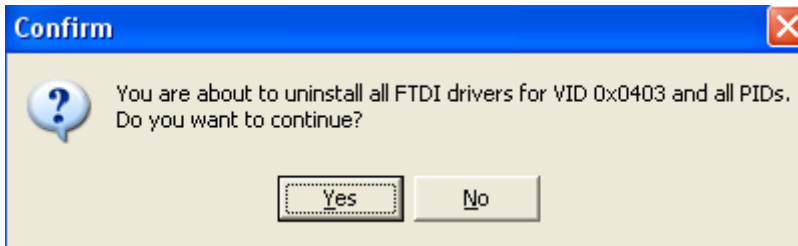

7. Click “No” to proceed.

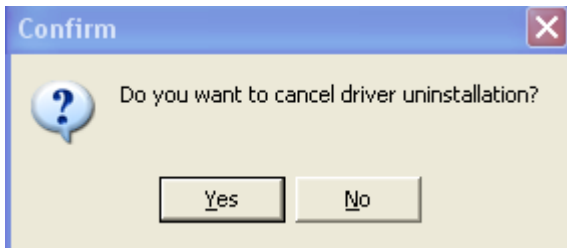

8. When the message “Status: System clean completed” appears, double click “Exit” to complete the USB to serial drivers uninstall.



9. Press “Start” button and select “Control Panel”.

**10. Open the Add or Remove program.**

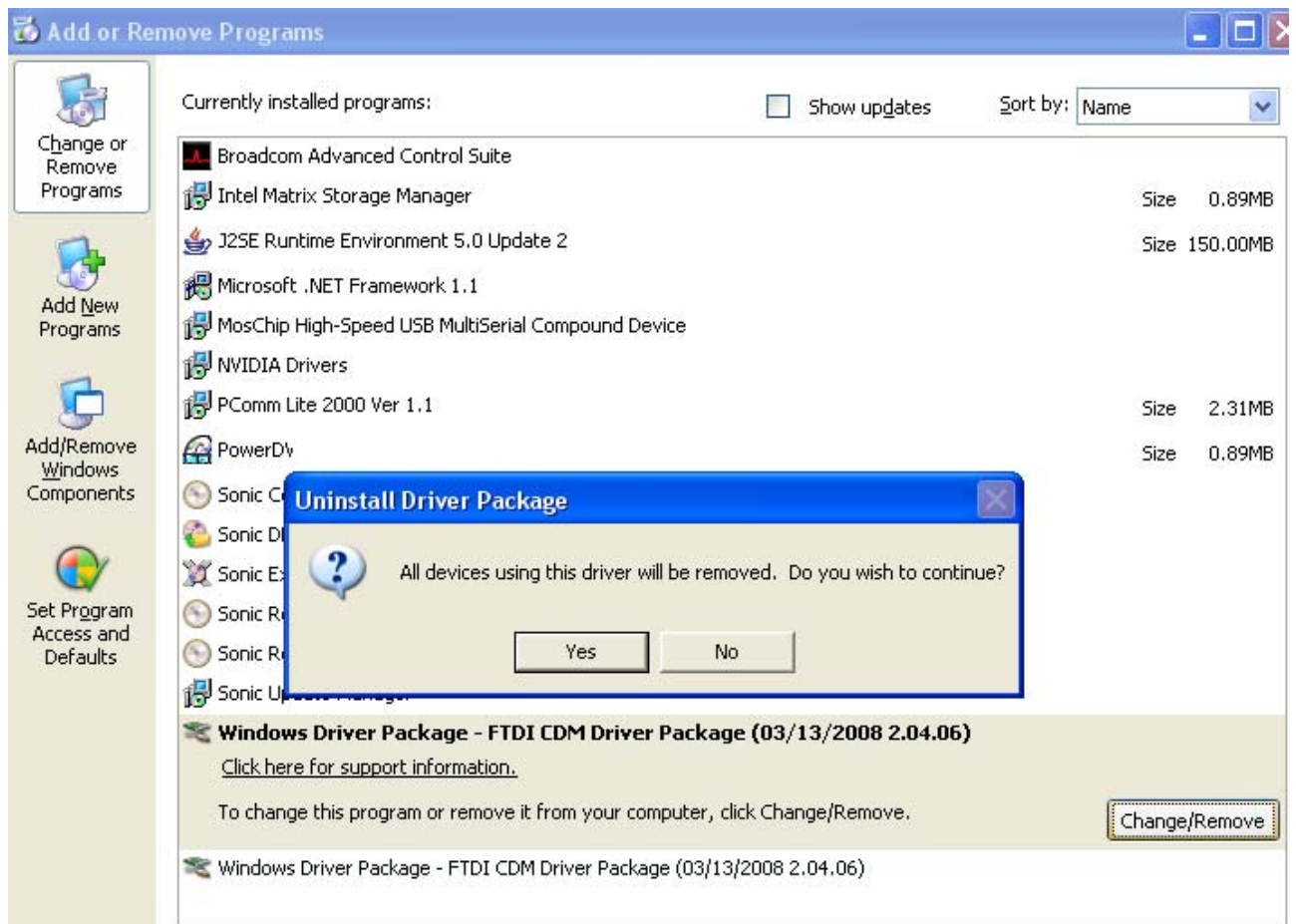

**11. Remove the first “Windows Driver Package – FTDI CDM Driver Package (...)”.**

**12. Click “Chang/Remove” and “Yes” to remove the first Windows Driver Package.**

**13. Remove the second “Windows Driver Package – FTDI CDM Driver Package (...)”.**

**14. Click “Chang/Remove” and “Yes” to remove the second Windows Driver Package.**

**15. Reboot the computer to complete the driver uninstall.**



## Uninstalling Windows 7 or Vista Drivers

Windows 7 and Vista have many new security features. You need to proceed with the following steps to uninstall the Vista driver:

1. The USB to serial devices must connect to the PC.
2. Press “Start” button and select “Control Panel”.
3. Select “Classic View” from the top left hand corner and then “System” from the list.
4. Select “Device Manager” from the top left hand corner.

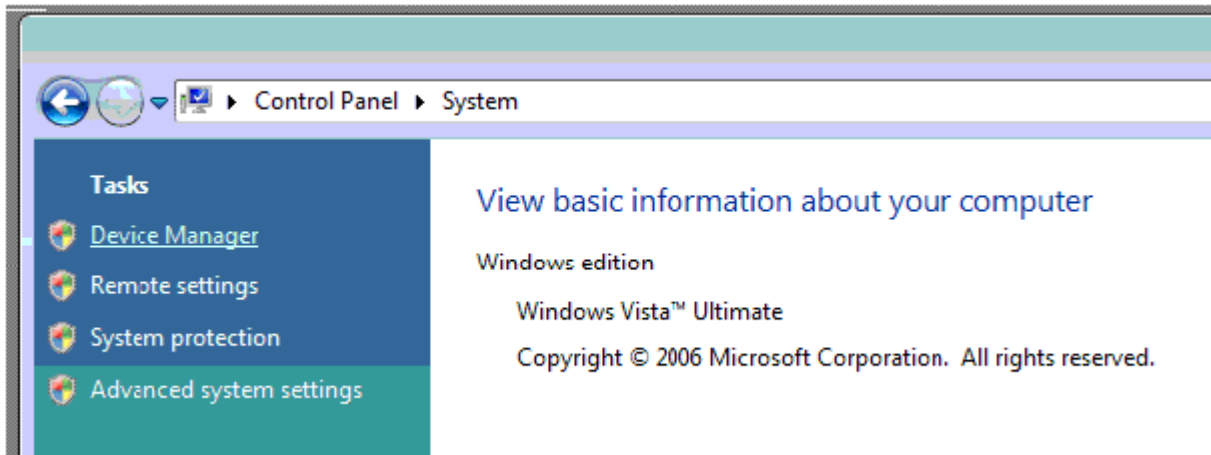

5. Locate your Device under the Ports (COM & LPT) section and right click on it to bring up the menu shown.

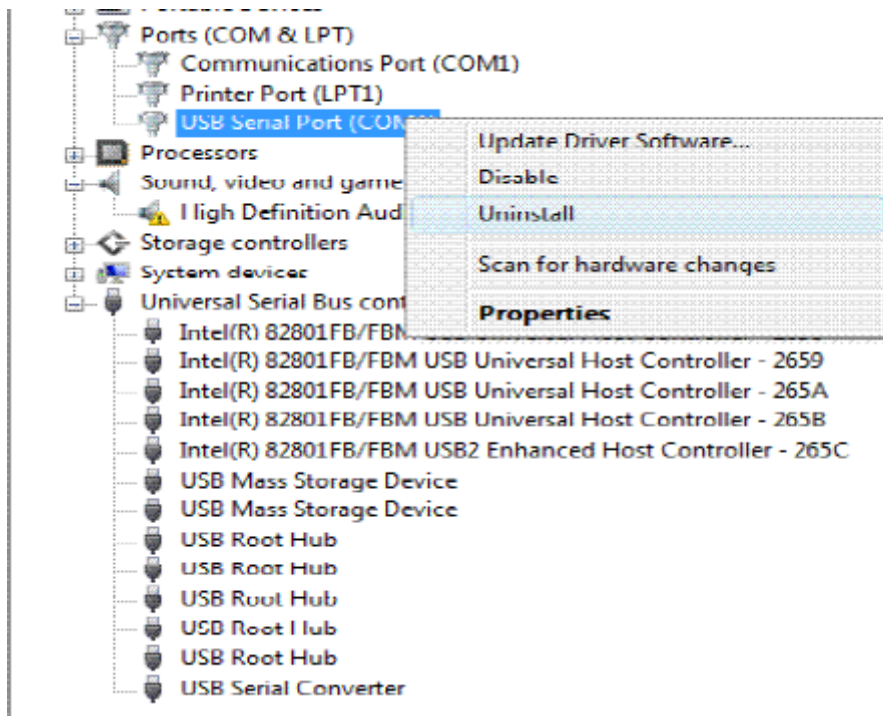

6. Select uninstall and be sure to click the box for “Delete the driver software for this device” in the next window and press “OK”.

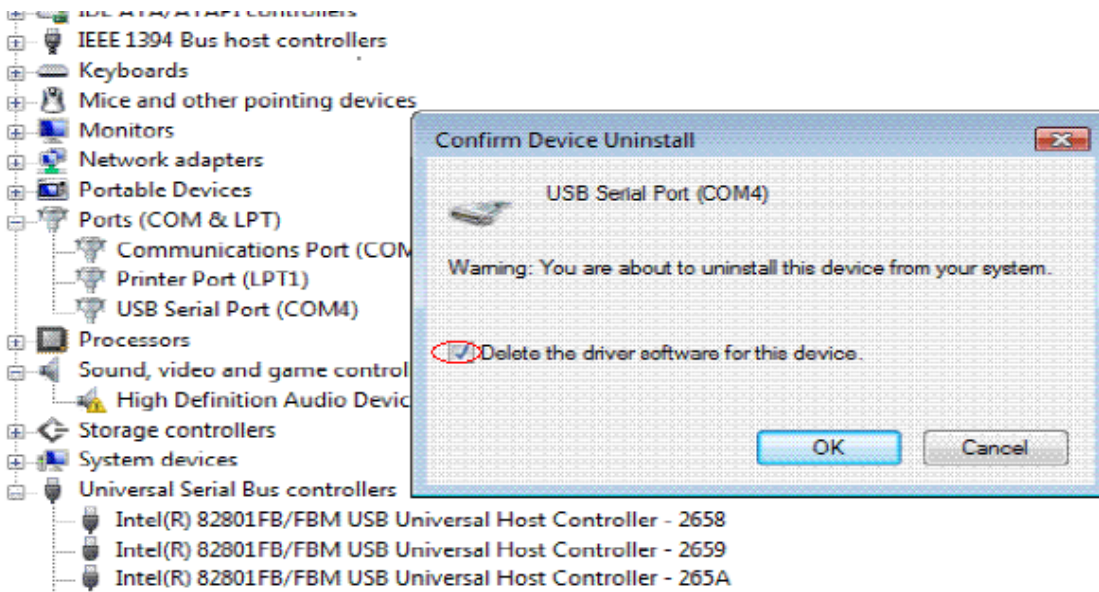

**Note:** if you have more than one USB Serial Port (COMx) installed in your PC, you need to repeat from step 5 to step 6 to delete the driver software for each port.

7. Locate your Device under the Universal Serial Bus Controllers section, and right click on it to bring up the menu shown.

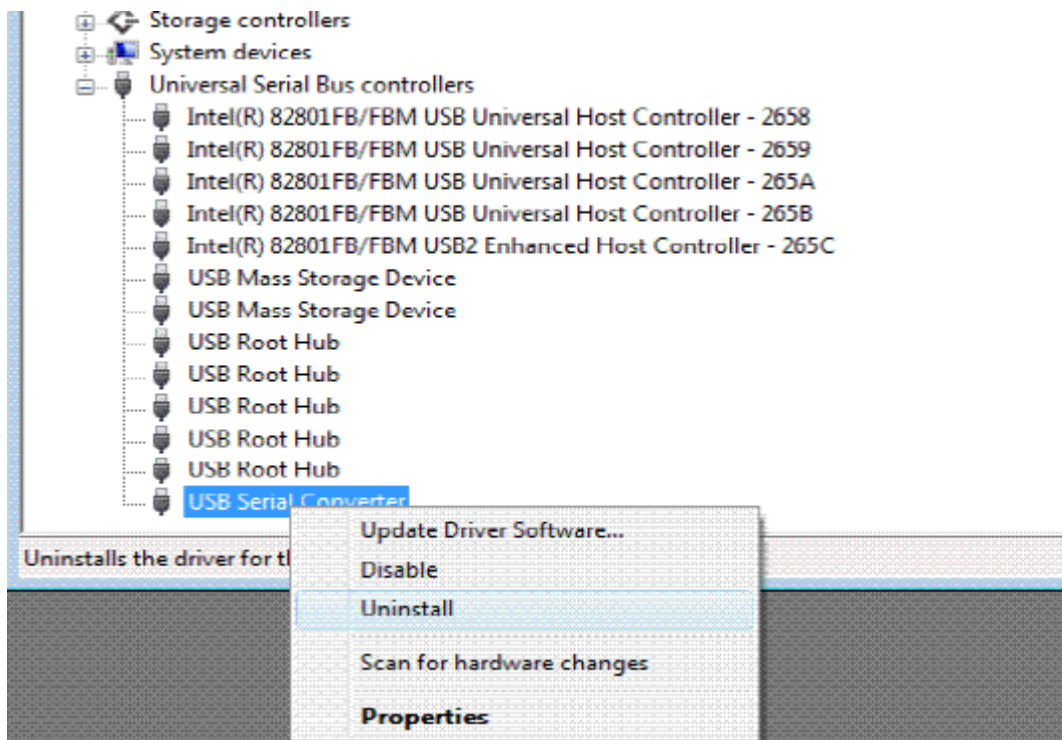

8. Select uninstall and be sure to click the box for “Delete the driver software for this device” in the next window and press “OK”.

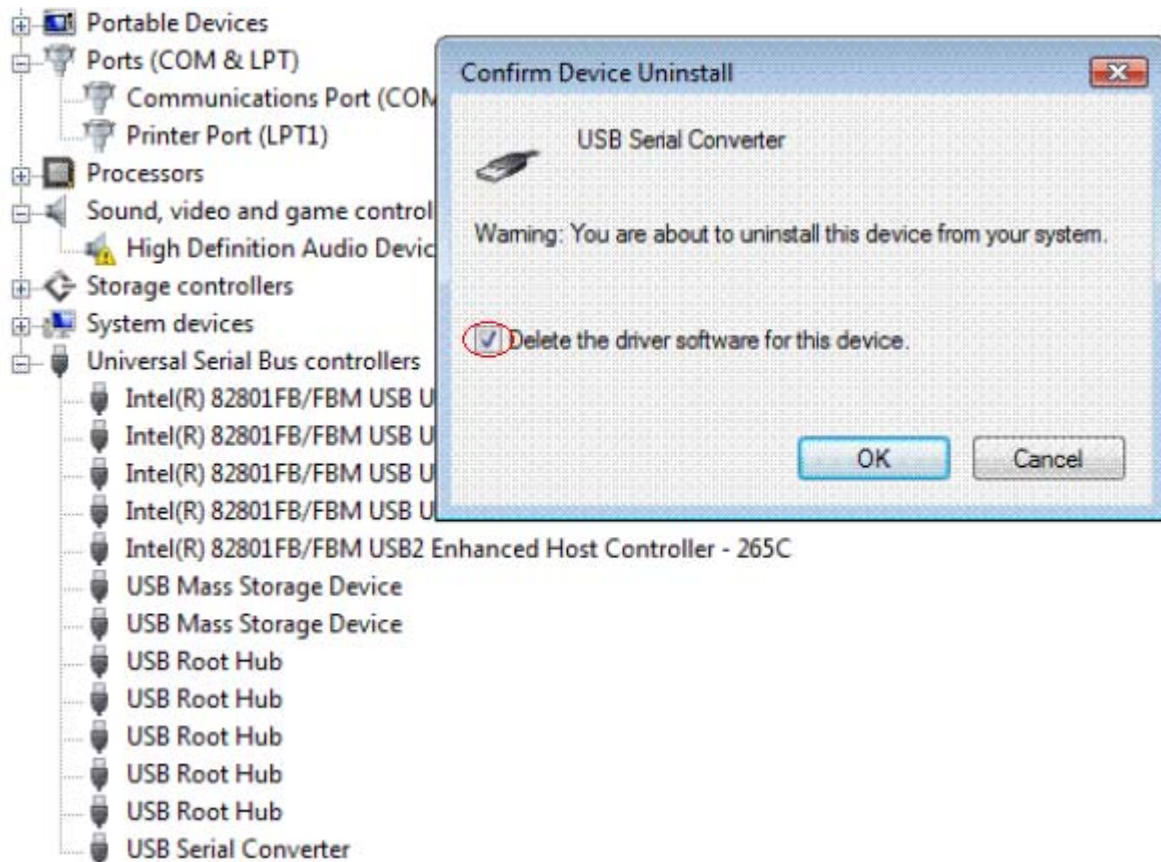

**Note:** if you have more than one USB Serial Converter installed in your PC, you need to repeat step 7 and step 8 to delete the driver software for all devices.

## RS-232 Signal Pin-outs of DB-9 Male

Pin 1	DCD
Pin 2	RxD
Pin 3	TxD
Pin 4	DTR
Pin 5	GND
Pin 6	DSR
Pin 7	RTS
Pin 8	CTS
Pin 9	RI

## RS-422 Signal Pin-outs of DB-9 Male

Pin 1	TxD- (A)
Pin 2	TxD+(B)
Pin 3	RxD+(B)
Pin 4	RxD-(A)
Pin 5	GND
Pin 6	RTS- (A)
Pin 7	RTS+(B)
Pin 8	CTS+(B)
Pin 9	CTS- (A)

## RS-422 Signal Wiring

- **Point-to-Point 4 Wire Full Duplex**

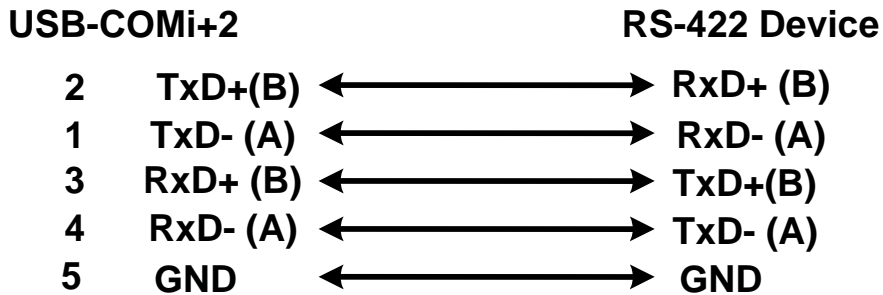

- **RS-422 with Handshaking**

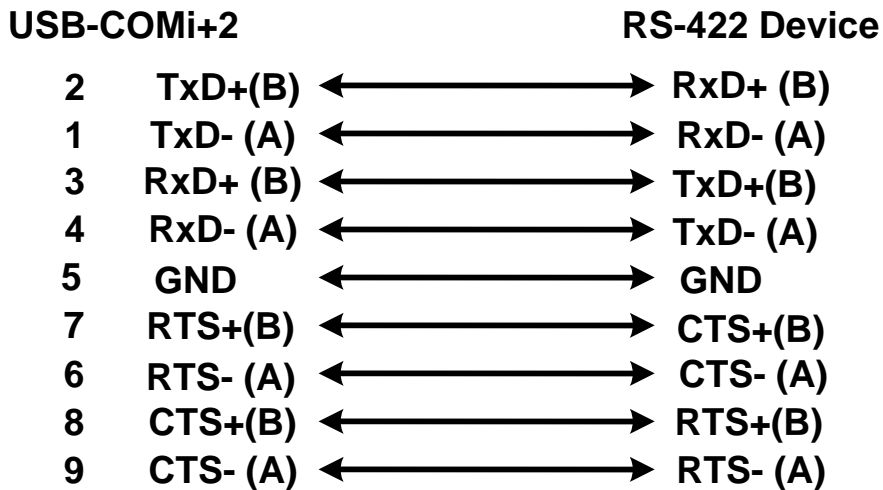

## RS-485 4-Wire (Full duplex) Signal Pin-outs of DB-9 Male

Pin 1	Tx- (A)
Pin 2	Tx+(B)
Pin 3	Rx+(B)
Pin 4	Rx-(A)
Pin 5	GND

## RS-485 2-Wire (Half duplex) Signal Pin-outs of DB-9 Male

Pin 1	Data- (A)
Pin 2	Data+(B)
Pin 5	GND

# RS-485 Signal Wiring

- **Point-to-Point 4-Wire Full Duplex**

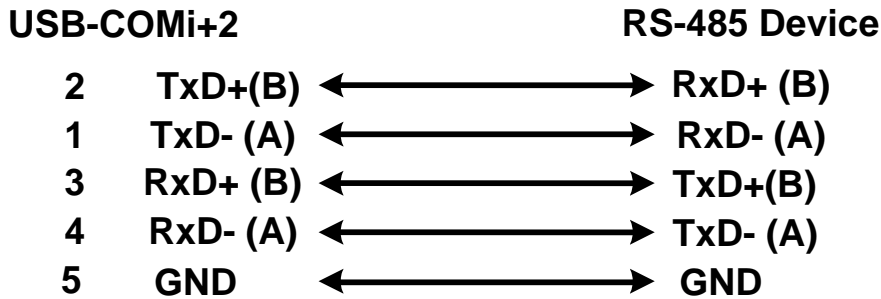

- **Multidrop RS-485 2-Wire Half-duplex**

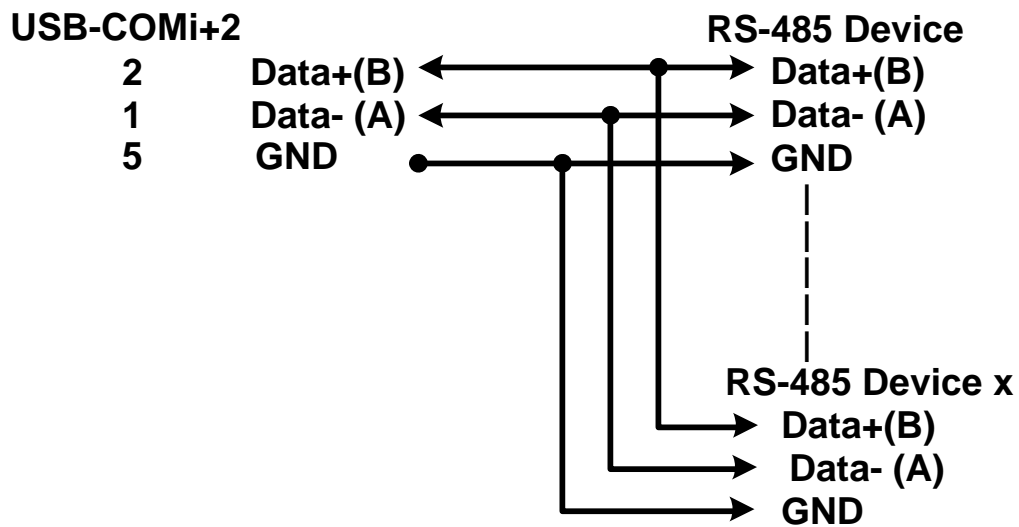

All brand names and trademarks are the property of their respective owners.  
Manual Part No. M063