

## Operation and Maintenance Instructions for Thermal Management System (TMS)

**Part Number: TMSB00000-01**

Fan speed controller, 1 to 4 fans,  
11-57V supply, highly configurable, alarm monitoring, enclosure.



Copyright (c) ebm-papst UK Ltd 2012

This document, including any concepts or techniques used,  
is the intellectual property of ebm-papst UK Ltd.

ebm-papst UK Ltd  
Chelmsford Business Park  
Chelmsford  
Essex  
CM2 5EZ

Tel: +44 (0) 1245 468555  
Fax: +44 (0) 1245 466336

[www.ebmpapst.co.uk](http://www.ebmpapst.co.uk)

The most recent version of this document is available for download at:

[www.ebmpapst.co.uk/instructions](http://www.ebmpapst.co.uk/instructions)

**INDEX**

- 1 SUMMARY..... 4**
- 2 MAIN FEATURES ..... 4**
- 3 DC SUPPLY..... 5**
  - 3.1 USE WITH -48VDC SUPPLY ..... 5
- 4 FAN INTERFACE ..... 5**
- 5 FAN CONTROL..... 5**
  - 5.1 TEMPERATURE PROFILE ..... 5
  - 5.2 MULTI-POINT PROFILE MENU OPTION ..... 6
  - 5.3 CONFIGURATION..... 6
  - 5.4 DUMMY FAN LINKS ..... 6
  - 5.5 DAILY FAN RUN ..... 6
  - 5.6 PWM FREQUENCY ..... 6
- 6 ALARMS..... 7**
  - 6.1 ALARM INTERFACE..... 7
  - 6.2 ALARM CRITERION..... 7
  - 6.3 ALARM ACTIONS ..... 7
  - 6.4 FAN FAIL CRITERION..... 7
  - 6.5 ALARM LED INDICATIONS..... 7
- 7 ENVIRONMENT ..... 7**
- 8 EMC COMPLIANCE..... 8**
- 9 SAFETY..... 8**
- 10 ROHS..... 8**
- 11 FUSES..... 8**
- 12 SWITCH INPUTS..... 8**
- 13 MECHANICS, ENCLOSURE..... 8**
  - 13.1 DIN RAIL MOUNTING ..... 9
- 14 INSTALLATION OF CONFIGURATION SOFTWARE ON PC..... 10**
  - 14.1 REQUIRED CONFIGURATION TOOLS ..... 10
  - 14.2 CONFIGURATION SOFTWARE INSTALLATION INSTRUCTIONS..... 10
  - 14.3 CONFIGURATION INTERFACE FAULT FINDING..... 11
- 15 CONFIGURATION AND MONITORING INTERFACE..... 13**
  - 15.1 WELCOME SCREEN, HEADER ..... 13
  - 15.2 WELCOME SCREEN, MEASURED VALUES ..... 13
  - 15.3 MEASURED VALUE DATA LOGGING ..... 13
- 16 CONFIGURATION FOR USER'S APPLICATION..... 14**
  - 16.1 MODE SELECT MENU..... 14
  - 16.2 CONFIGURATION OF FAN CHARACTERISTICS ..... 15
  - 16.3 CONFIGURATION OF TEMPERATURE PROFILE ..... 18
    - 16.3.1 Multi-point Temperature Profile ..... 22
    - 16.3.2 Temperature Profile, Temperature sets RPM (closed loop) mode ..... 23
  - 16.4 ALARM CONFIGURATION ..... 24
    - 16.4.1 Alarm Configuration Example 1 ..... 25
    - 16.4.2 Alarm Configuration Example 2 ..... 25
    - 16.4.3 Relay Daughterboard [PROVISIONAL] ..... 26
  - 16.5 CONFIGURATION FILE MENU (LOAD, SAVE, ETC.) ..... 27
    - 16.5.1 To read (load) an existing configuration file from the PC ..... 27

16.5.2	To save (write) an existing configuration file to the PC .....	28
16.5.3	Set Default Configuration.....	29
16.5.4	Restart TMS Program.....	29
<b>17</b>	<b>IDENTIFICATION OF CONNECTORS, LED'S AND PIN NUMBERING.....</b>	<b>30</b>
17.1	CONNECTORS, FRONT EDGE OF PCB, PIN NUMBERING .....	30
17.2	CONNECTORS, REAR EDGE OF PCB, PIN NUMBERING .....	30
<b>18</b>	<b>MATING CONNECTOR TYPES AND PIN CONFIGURATION .....</b>	<b>31</b>
	FRONT EDGE CONNECTIONS .....	31
	POWER INPUT .....	31
	FANS .....	31
	CRIMPS FOR POWER AND FAN CONNECTORS.....	31
	THERMISTORS AND 0-10V INPUTS .....	31
	RELAY OUTPUTS, RELAY 1.....	31
	REAR EDGE CONNECTIONS.....	32
	RELAY OUTPUTS, RELAYS 2-4.....	32
	RELAY EXPANSION .....	32
	SWITCH INPUTS 1-2.....	32
	CRIMPS FOR NTC THERMISTORS, RELAY OUTPUTS, SWITCH INPUTS, RELAY DAUGHTERBOARD AND CONFIGURATION INTERFACE .....	32
	RS485 INTERFACE (CUSTOMER SPECIFIC SOFTWARE USE ONLY.) .....	32
	END CONNECTIONS .....	32
	COMS - CONFIGURATION AND MONITORING INTERFACE .....	32
	TEST CONNECTOR.....	32
<b>19</b>	<b>THERMISTORS.....</b>	<b>33</b>
19.1	THERMISTOR CABLE ASSEMBLY ACCESSORY.....	33
<b>20</b>	<b>RELAY DAUGHTERBOARD ACCESSORY (PRELIMINARY).....</b>	<b>33</b>
<b>21</b>	<b>DUMMY FAN LINK ACCESSORY.....</b>	<b>33</b>
<b>22</b>	<b>CONFIGURATION CABLE ASSEMBLY ACCESSORY .....</b>	<b>34</b>
<b>23</b>	<b>DEVELOPMENT CABLE SET ACCESSORY .....</b>	<b>34</b>
<b>24</b>	<b>FAN COMPATIBILITY AND EXAMPLE RECOMMENDED SETTINGS.....</b>	<b>34</b>
24.1	RECOMMENDED FAN SETTINGS.....	34
<b>25</b>	<b>TMS / HMS CONTROLLER, SUMMARY OF DIFFERENCES.....</b>	<b>36</b>
<b>26</b>	<b>CE CERTIFICATE, COPY OF FRONT SHEET .....</b>	<b>37</b>

## DOCUMENT HISTORY

Issue	Date	Comments	Name
5	9 Oct 2012	Add Fan Configuration Examples	JE
4	20 July 2012	Add Relay type Fans, Daily Fan Run & PWM Freq.	JE
3	2 Sept 2011	Correct Power Connector pin-out	JE
2	10 June 2011	Update 0-10V input, document number changed	JE
1	13 May 2011	Update instructions, Relay 2-4 connector combined	JE

The master of this document is stored at ebm-papst Chelmsford, Essex, UK:  
 T:\Design Projects\6685 - Thermal Management System - epUK\Specifications\OMI

## 1 Summary

This controller sets the speed of up to four fans, based on temperature. It is designed for use with four wire type fans (Power, 0V, Speed control, Tachometer) on 12V, 24V or 48V systems. It can also be used with mains powered EC fans if TMS power supply is provided.

Each fan may be configured for a different speed/temperature profile.

0-10V or Open Collector speed controlled type fans.

Open Collector Tachometer, Open Collector Alarm or Relay Alarm type fans.

Configurable Alarm actions (fan speed change, Alarm relays operate)

Customer configurable or may be supplied programmed to required profile.

Open Loop or Closed Loop control configurable option, Thermistor or 0-10V inputs.

## 2 Main Features

- Control of four wire fans (Power, 0V, Speed control, Tachometer/Alarm Relay).
  - Supply Voltage covers 12VDC, 24VDC and 48VDC nominal (11-57 VDC).
  - Open Collector PWM fan speed control, 11-57 VDC supply.
  - 0-10V PWM fan speed control, 16-57 VDC supply
  - Fan speed based on temperature profile, independent profile for each fan.
  - Compatible with tachometer, Alarm Relay, Open Collector alarm type fans
  - 1-4 Fans, separate plug connector for each fan.
  - Fans powered via controller PCB, up to 11A total fan supply.
  - Tachometer/Alarm monitoring of all 4 fans, configurable alarm actions.
  - Temperature monitoring, configurable alarm actions.
  - Thermistor inputs, 2 off, configurable selection to control each fan.
  - Switch Inputs, 2 off, suitable for e.g. door alarms, test switch, fan boost.
  - Relay alarm outputs, 4 off, Solid State Relays, contacts rated 60VDC, 100mA.
  - [PRELIMINARY] Daughter board option for two off Power Relays, contacts rated 230VAC 10A.
  - All TMS connections use plug-in connectors.
  - Side connectivity for low profile.
  - Alarm LED's show different alarm states.
  - Alarm LED's visible from both top and side, sited close to the edge of the PCB.
  - PC Interface for Configuration and Data Logging, electrically isolated.
  - Low power consumption, typical 10mA running from 24V/48V supply.
  - Enclosure, DIN rail mountable.
  - Thermistor inputs may be configured to operate as 0-10V inputs.
  - All configuration settings stored in memory, no switches / links / potentiometers.
  - RS485 Interface, non-isolated. \*
  - ebm-papst EC-Matrix compatible control interface. \*
- \*(Supported in customer specific software only, contact ebm-papst.)

### 3 DC Supply

Supply Voltage covers 12V, 24V and 48V ranges (11- 57 VDC) SELV

Supply reversal protection for controller circuitry.

Supply Current:

25mA max for controller only, typical 10mA running.

11A max steady state total current including fan supply.

Earthing – no part of the controller or fan circuit is connected to Chassis/Earth.

Suitable for use on positive or negative earth (-48VDC) systems.

Green Power LED will pulse slowly when power connected.

#### 3.1 Use with -48VDC supply

The TMS is compatible with -48VDC supplies typically used in telecommunications systems.

Considerations for -48VDC supply use:

- 1) Connect -48V to Power Connector pin 2, and the more positive supply lead to pin 1.
- 2) The Thermistors, Fan Speed Control and Fan Tachometer lines are referenced to the negative supply lead. Irreparable damage is likely if these signal wires are allowed to connect to any Earthed metalwork.
- 3) Consideration should be given to fitting fuses in the negative supply leads.
- 4) The TMS is equipped with an electrically isolated configuration interface to protect the user's PC while using this interface.

### 4 Fan Interface

Four-wire fans (Supply, 0V, PWM Speed Control, Tachometer/Alarm).

For Fan Supply via PCB, each fan maximum 130W at 48V.

Speed control output to fan, 0-10V or Open Collector PWM, configurable frequency

(0-10V control requires 24 or 48V supply). Inverted control profile option.

Tachometer Input from fan, Open Collector compatible 1-6 tachometer pulses / revolution or

Open Collector Alarm (low for normal, open for Fan Alarm) or Relay Alarm type fan (closed

for normal, open for Fan Alarm). Connect the fan Alarm Relay between Tachometer and 0V.

The red Fan LED next to the Fan Connector will illuminate during Fan alarm.

### 5 Fan Control

#### 5.1 Temperature profile

Temperature/Control profile is configurable, an example of a profile can be seen below

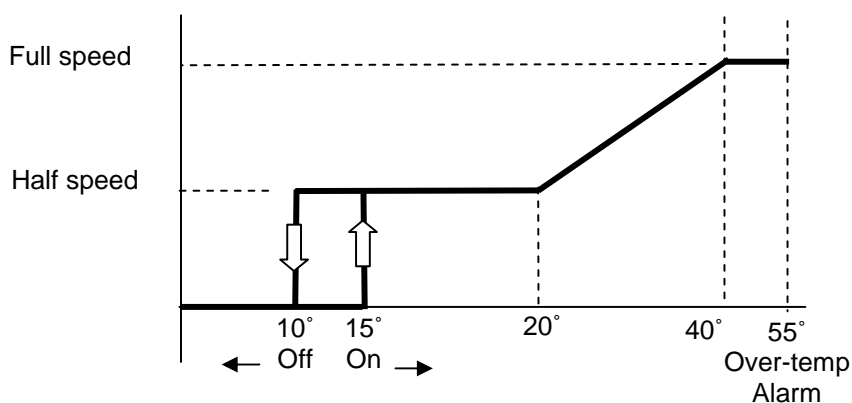

Each fan may have a different profile using either thermistor as configured.

The fans can be set to switch off at low temperature, programmable option, individually programmable on and off points.

## 5.2 Multi-Point profile menu option

Optionally, the Temperature/Control Profile may be changed from the simple linear slope shown above to a multi-point profile. This allows intermediate points to be set on the slope.

## 5.3 Configuration

The TMS may be configured by connection to a PC using the configuration cable, see section “*Configuration Cable*” below, with the PC running a Terminal Emulator program, see section “*Installation of Configuration Software on PC*” below.

The unit may be configured by loading a previously created Configuration File, or by setting parameters individually. The new configuration may then be saved to a Configuration File.

### **Configurable settings, each set independently for each fan:**

Low temperature shut-off temperature points (enabled/disabled), Start of temperature control band and Top of temperature control band.

Fan speed at defined temperatures.

Configured to be controlled by either Thermistor 1 or Thermistor 2 or Both (highest of the two)

May be set for higher speed at higher temperature (“Cooling profile”) or lower speed at higher temperature (“Heating Profile”)

Alarm temperature thresholds, configurable.

Alarm actions can set each Fan Speed independently.

Tachometer - the number of pulses per revolution may be configured in range 1-6 pulses/rev.

The Fan Speed Control PWM Output may be set to 0-10V or Open Collector.

The PMW output slope may be inverted, i.e. selectable between “PWM 0V out = fan off” and “PWM 0V out = fan full speed”.

### **Global configurable settings, set for all fans together:**

Control mode Open Loop (set PWM Output) or Closed Loop (set Fan RPM)

Thermistor inputs configurable as 0-10V inputs.

Enable Relay Daughterboard.

Enable Multi-Point temperature profile, see below.

Fan Speed Control PWM Frequency

Daily Fan Run

Dummy Fan links Enabled/Ignored

## 5.4 Dummy Fan Links

If configured to “ALLOWED” a Dummy Fan Link ebm-papst part number 210-HAR12141 may be fitted to suppress alarms from an unfitted fan.

The link presence is checked during power-up only.

Normally the link option would simply be configured to “Not Fitted”, but this feature is used by customers who prefer to have a single programmed configuration (i.e. single TMS variant) for applications with different quantities of fans, as this reduces their spares holding requirement.

A Fan or Link is then connected as required on a per site basis.

## 5.5 Daily Fan Run

The Fans may be configured to shut off at low temperatures (common in street cabinet applications). In order to have confidence that the fans will restart after what may be an extended off period in adverse conditions, the fans may be configured to briefly run once per day for test, even though remaining below the configured shut-off temperature.

## 5.6 PWM Frequency

The fan speed control PWM frequency may be varied if required for the fans being used, see fan data sheet. Most fans will operate correctly at the default value.

## **6 Alarms**

### **6.1 Alarm Interface**

Solid State Relays, contact rating 0.1A, 60VDC. Single contact per relay either open or closed, (no Change-Over contacts on board).

Alarm Relay default setting:

Contact closed in normal operation (alarm inactive),

Contact will open for alarm active including power fail (fail safe operation).

Option to invert relay operation so contacts close when alarm active and open for no alarm, except relay contacts always open when unit not powered.

Relays may be configured to change state on Fan Alarm or Temperature Alarm or Switch Input, or 0-10V input voltage if selected instead of Thermistor. Other Relay option, see below.

Red Alarm LED will illuminate when one or more of the configured alarm criterion is active.

### **6.2 Alarm Criterion**

Supply power fail – all relay contacts open, all Alarm LED's off.

An alarm may be raised in the event of any of the following, configurable by program:

- 1) One or more fan(s) failed – defined as not achieving set speed, within tolerance.
- 2) Either thermistor indicates temperature (configurable threshold, configurable to alarm Above or Below threshold)
- 3) Thermistor input open or short circuit
- 4) Temperature differential between thermistors (configurable threshold)
- 5) Switch Input High/Low, configurable.
- 6) 0-10V input voltage level if TMS configured for 0-10V input instead of Thermistor.

The temperature alarm threshold incorporates hysteresis.

The Fan Fail alarm incorporates a delay.

### **6.3 Alarm Actions**

In the event of an alarm the following actions are configurable by program:

- 1) Alarm Relay contacts change (for power fail all relay contacts open)
- 2) Depending upon failure other fans will react to compensate, configurable by program.
- 3) Alarm Fan Speed setting overrides temperature based speed control for the duration of the alarm.

Alarms are non-latching.

### **6.4 Fan Fail Criterion**

“Fan Fail” defined as fan not reaching set speed (within tolerance) within a set period.

If the PWM output is set below 20% the Fan Fail alarm will be inhibited, to allow for undefined operation around the fan start-up point.

**Note:**

The Fan Tachometer alarm is configurable to be inhibited on a per-fan basis, may be used when connected to a fan with no Tachometer or other Open Collector / 0-10V controllable device.

### **6.5 Alarm LED Indications**

Alarm LED indication of power/fan/thermistor/Expansion board fail.

## **7 Environment**

Operating Temperature range -40°C to 70°C

Operating Humidity range 0-95% Non Condensing at 40°C max

## **8 EMC Compliance**

Radiated Emissions BS EN55022:2006, Class B

Radiated Immunity EN61000-4-3:2002 +A1+A2

Fast Transient Bursts EN61000-4-4:2004

Conducted Immunity EN61000-4-6:2007

Notes:

- 1) No filtering of fan supply or fan supply inrush limiting provided.
- 2) It is recommended that sensor and control cables over 3m length are screened.
- 3) Route sensor and control wiring separately from AC mains wiring
- 4) Any connection to a DC Distribution Network should be made via an EN61000-4-5 compliant interface

## **9 Safety**

Compliant with EN60950.

All plastic components used on the controller are Flammability rating UL94V-0 or better.

Installation must be by qualified personnel in accordance with local applicable standards.

This appliance is intended to be enclosed in the equipment and not accessed by the user.

Access is limited to service personnel only.

Residual risk of contact with fan. Maintenance personnel should take due care and attention.

## **10 RoHS**

The controller is RoHS compliant.

## **11 Fuses**

Auto-resetting fuse for controller supply.

Fan supply not fused, relies on external fusing.

The controller must be powered from a 15A maximum fused supply.

## **12 Switch inputs**

Isolated switch contact or open collector compatible (referenced to negative supply lead).

Quantity two.

Pull-up resistor on controller PCB.

Suitable for e.g. door alarms, test switch, fan boost.

Configurable to change Fan speed or change Alarm Relay state.

## **13 Mechanics, Enclosure**

Cover / guard to prevent accidental contact with controller.

Connectors accessible and Alarm LED's are visible with cover fitted.

The following connectors mounted along one edge of PCB:

Power, four Fans, two Thermistors, one Relay Alarm Output

Other connectors mounted on opposite edge:

Three Alarm Relays, RS485, Relay Daughterboard connector, two switch inputs.

Configuration connection at end.

Enclosure Length = 143mm

Enclosure Width = 65.5mm

Enclosure Height = 23mm

Fixing Hole Size 3.5mm diameter (4 off)

Fixing centres 134x55mm

**980-CAS11007, Controller PCB Dimensions:**

119x65.5mm

Fixing Hole Size 3.5mm diameter (4 off)

Fixing centres 110x53mm.

**Weight:** PCB plus enclosure = 170g



### ***13.1 DIN Rail Mounting***

The TMS enclosure is fitted with 2 holes 4.1mm diameter on 134mm centres designed to accept DIN mounting clips as shown in the diagram below. The fixing holes are compatible with DIN mounting clip Weidmuller part number 0687900000. Fixings required M4 screws length 8mm, plus spacers (e.g. M4 nuts).



## 14 Installation of Configuration Software on PC

### 14.1 Required Configuration Tools

**Hardware:**

For configuration, the TMS is designed to be connected to a PC using an ebm-papst supplied cable assembly ebm-papst part number 210-HAR11887, PC USB to TTL serial data adapter. The appropriate driver program must be installed on the PC, instructions below. The cable and the driver software have been tested with the TMS on MS XP, Vista & Windows 7 operating systems.

**Software:**

The data is displayed on and generated from a PC using Terminal Emulator software. The recommended software is TeraTerm, open source software, installation instructions below. This software has been tested with the TMS on MS XP, Vista & Windows 7 operating systems.

**Terminal Emulator and USB Driver software Download:**

The USB adapter driver and Terminal Emulator software may be downloaded from: <http://sites.google.com/site/serialdrivers/files> file name "serial.zip".

### 14.2 Configuration Software Installation Instructions

- 1) Unzip the file. It contains CDM20802\_Setup.exe and teraterm-4.66.exe
- 2) Double click on CDM20802\_Setup.exe to install the drivers for the configuration cable. The pop-up window shown below should be displayed briefly (file path will vary):

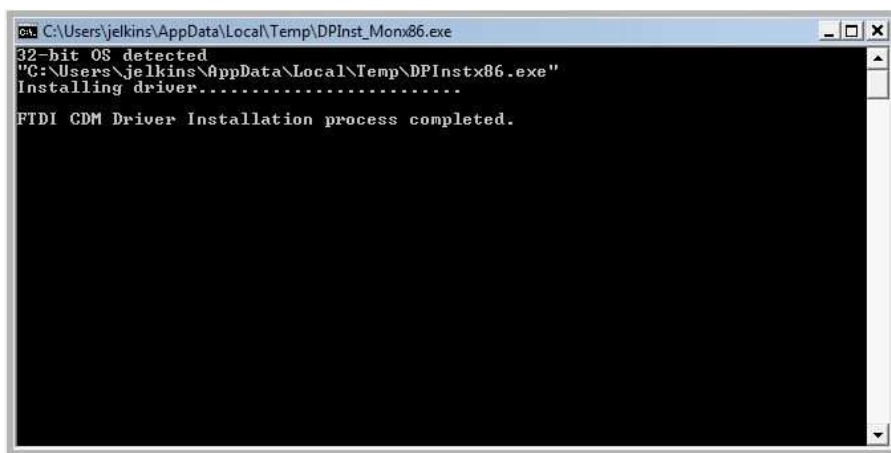

- 3) Double click on teraterm-4.66.exe to install the terminal emulator program. The pop-up window shown below should be displayed:



- Click “Next”, accept the license and all the defaults for TeraTerm but then click CANCEL when prompted to install both LogMeTT and TTLEditor.
- 4) Plug the cable assembly ebm-papst part number 210-HAR11887 into a spare PC USB connector and connect the other end to a powered TMS control PCB “COM” connector.
  - 5) Double click on the TeraTerm desktop icon to run it.
  - 6) In the TeraTerm new connection popup change the TCP/IP selection to Serial
  - 7) Click the Port drop down menu & select the port shown as USB Serial Port (Port

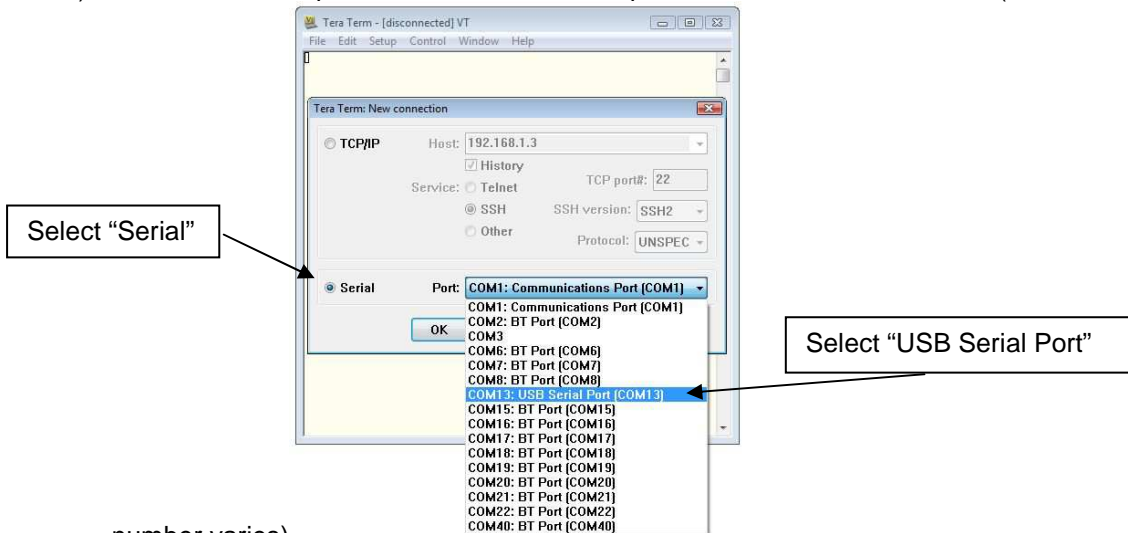

- number varies)
- 8) Leave the “Serial” settings as default, i.e. 9600Baud, 8bit, no parity, 1 stop bit, no flow control. Do not enable Local Echo.
  - 9) Click OK.
  - 10) Data from the TMS should now be displayed on the TeraTerm window. To display the full configuration, press the [Enter] key on the PC keyboard. Change the font or window size to user’s preferred setting if desired, using the “Setting” drop-down menu. The font “Courier New” is recommended
  - 11) Select “Setup, Save Setup” from the drop down menu if desired to save the connection Port, Font, and Window Size setting. Note – if saved, then if another cable assembly ebm-papst part number 210-HAR11887 is connected it will not be recognised. Uninstall then reinstall the TeraTerm software to use another cable.
  - 12) Note – the TMS COM connector may be removed & reconnected and the TMS power cycled without affecting the Terminal program. If the USB connector is removed & reconnected the Terminal program must be restarted.

### 14.3 Configuration interface Fault Finding

- 1) If no data is being displayed check the serial configuration (Setup, Serial Port and Port Number) as shown above. The default configuration should work correctly.
- 2) As each key is pressed on the PC the “COM” LED D34 on the TMS should illuminate briefly. This will work even with no power supply to the TMS. This LED is located next to the configuration connector on the TMS PCB, it is just visible through the enclosure

Fan1 connector cut-out. Do not confuse this with the Fan1 status LED.

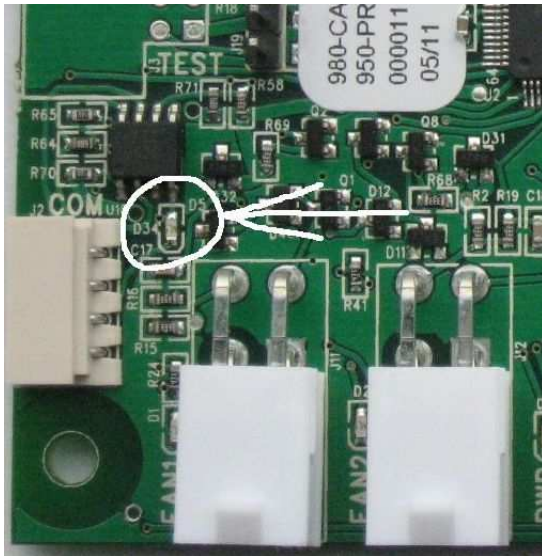

“COM” LED D34 location

- 3) Another check is to disconnect the TMS and link configuration lead connector pins 2&3 directly, then check characters typed on the PC keyboard are echoed back to the screen.
- 4) If the USB cable is changed for another USB cable then the Port Number assignment may need to be reset. The simplest way to do this is to uninstall then reinstall the Terminal Emulator software (TeraTerm). This will clear the user settings which include the port number. It is not necessary to reinstall the USB-Serial cable driver.
- 5) If the driver installation pop-up window is not displayed as shown then run the CDM20802\_Setup.exe driver installation program again.

## 15 Configuration and Monitoring Interface

The TMS may be configured and monitored by connection to a PC, with the PC running a Terminal Emulator program, see section “*Installation of Configuration Software on PC*” above.

### 15.1 Welcome Screen, Header

Text similar to the following will be displayed at power-up:

```

TMS Controller
ebmpapst UK
    
```

```

TMS Thermal Management System, (c) ebm-papst UK Ltd 2012
Fan Speed Controller
Prog. 950-PRG11016 1.0.76, Jul  3 2012 16:39:38
    
```

```

Press [m] for Mode select Menu (ADVANCED)      Press [c] for Configuration File Menu
Press [f] for Fan Characteristics Menu         Press [L] for file Logging output toggle
Press [t] for Temperature/Control Profile Menu Press [SPACE] to display this menu
Press [a] for Alarm & Relay Menu               Press [ENTER] to display all settings
    
```

```

----- MEASURED VALUES -----
RPM1,PWM,   RPM2,PWM,   RPM3,PWM,   RPM4,PWM,   NTC1,  NCT2, INP1, INP2,ALARMS,Uptime(s)
 341, 25,    336, 25,    340, 25,    349, 25,    7.8,   9.8, HI  , HI  ,____ , 10s
    
```

To display the full configuration, press the [Enter] key on the PC keyboard  
 To display the configuration menu and measurement header, press [space].

### 15.2 Welcome Screen, Measured Values

```

----- MEASURED VALUES -----
RPM1,PWM,   RPM2,PWM,   RPM3,PWM,   RPM4,PWM,   NTC1,  NCT2, INP1, INP2,ALARMS,Uptime(s)
 341, 25,    336, 25,    340, 25,    349, 25,    7.8,   9.8, HI  , HI  ,____ , 10s
    
```

Displays the current values of Fan PWM (based on temperature profile configuration and measured temperature & alarm state) plus the measured RPM and Temperatures. Also displays the Switch Input state and any active Alarms, and seconds since power on. For Closed Loop modes the Target RPM will be displayed instead of the PWM Output. If 0-10V input selected (instead of Thermistor) then the voltage will be displayed.

### 15.3 Measured Value Data Logging

The measured values display is updated each second. To display each set of measured values on a new line, type “L”, to cancel type “L” again. The values may be saved to a log file. To do this, choose Log... from the TeraTerm File menu, type in a file name in the resulting dialogue box and select the location in which to save it. Ensure each set of data is being displayed on a new line as shown below.

As the data values are separated by a comma (CSV format) they are suitable for direct importing into a spreadsheet program such as MS Excel.

A text editor may be used to view the file. Some editors may reformat the file making it difficult to read, the notepad++ open source text editor is recommended.

```

----- MEASURED VALUES -----
RPM1,PWM,   RPM2,PWM,   RPM3,PWM,   RPM4,PWM,   NTC1,  NCT2, INP1, INP2,ALARMS,Uptime(s)
FAIL, 20,    FAIL, 20,    FAIL, 20,    FAIL, 20,    FAIL,  ____,low , HI  ,1234 , 6s
FAIL, 20,    FAIL, 20,    FAIL, 20,    FAIL, 20,    FAIL,  ____,low , HI  ,1234 , 6s
1233, 21,    1221, 21,    1234, 21,    1235, 21,    22.7, 25.0,low , HI  ,____ , 7s
1286, 22,    1250, 22,    1279, 22,    1283, 22,    14.7, 25.6,low , HI  ,____ , 8s
1317, 24,    1305, 24,    1342, 24,    1313, 24,    10.9, 26.0,low , HI  ,____ , 9s
    
```

## 16 Configuration for user's application

### Notes:

- 1) This controller is designed to be highly configurable. A user changing the configuration settings should be familiar with terms such as PWM, RPM, Proportional Band, Open Collector, etc, and the concepts associated with fan speed control.
- 2) The configuration may be updated by loading a Configuration File. This may be done by ebm-papst prior to TMS delivery (volume customers, contact ebm-papst). The instructions in this section are for use when creating a new configuration.
- 3) A configuration file may be loaded, modified, and then saved again.
- 4) The configuration should be set in the following sequence for each setting requiring to be changed:
  - a. Operating Mode (usually default, "Temperature sets PWM Output")
  - b. Fan Characteristics (see fan data sheet)
  - c. Temperature/Control Profile (as customer requirement)
  - d. Alarms & Relays (as customer requirement)
  - e. Configuration File save (if required)
- 5) Within any sub-menu the parameters may generally be set in any sequence.
- 6) Each configuration change will be implemented as soon as it is entered, e.g. fan speed will change if required by temperature profile change.
- 7) Each configuration setting will be stored in non-volatile memory as it is entered.
- 8) The TMS program will attempt to disregard invalid settings, or limit the values to the permitted range.
- 9) If the controller is left displaying a configuration menu for an extended period with no key press on the PC, the controller will reset then return to the normal operating display.

### 16.1 Mode Select Menu

The Operating Mode of the controller may be set as follows, type "m" for Control Mode Configuration menu, display will be as shown:

```

----- OPERATING MODE -----
Operating Mode = "Temperature sets PWM Output" (Open Loop)

Press "1" for "Temperature sets PWM Output" (Open Loop)
Press "2" for "Temperature sets Fan RPM" (Closed Loop)
Press "3" for "0-10V input sets PWM Output" (Open Loop)
Press "4" for "0-10V input sets Fan RPM" (Closed Loop)

Press "p" to change Project Specific Mode (ADVANCED)

### CAUTION - CHANGING OPERATING MODE WILL OVERWRITE SETTINGS ###

Select new operating mode or Press SPACE to exit
  
```

Mode 1, "Temperature sets PWM Output" is an Open Loop control mode and the most commonly used operating mode. The fan is set to a proportion of its operating speed range e.g. 50%, rather than a specific RPM value. In this mode Fan Fail criterion is defined as measured fan RPM deviates too far from the predicted RPM, based on "Maximum Fan RPM" configuration setting in "FAN CHARACTERISTICS" menu. This mode may also be used to control a device with no Tachometer connection, see below.

Mode 2, "Temperature sets Fan RPM" is a Closed Loop control mode, i.e. the fan speed control will be continuously adjusted to bring the measured fan RPM to the set value. This mode is similar to the operating mode of the ebm-papst HMS Controller and may be preferred by users familiar with that controller. In this mode Fan Fail is defined as fan does not reach the RPM configured in the Temperature Profile.

Modes 3 and 4 map 0-10V inputs to Fan RPM or PWM output for other control applications.

Project Specific Mode - ONLY CHANGE THIS SETTING IF ADVISED BY ebm-papst, this is the access point for customer specific software features.

Changing operating mode will set many of the temperature / control and Alarm parameter settings to the default setting for the new mode.

## 16.2 Configuration of Fan Characteristics

Consult fan data sheet for required settings.

Type "f" for Fan Configuration menu, display will be as shown:

Fan Characteristics Configuration Menu

```

----- FAN CHARACTERISTICS -----
Fan      Used      Pulses/   Control      Stationary    Ramp    Data Sheet
          Rev.      Type       PWM%         Rate          Max Fan RPM
1         Y          2         Open_Collector 0            10        3000
2         Y          2         Open_Collector 0            10        3000
3         Y          2         Open_Collector 0            10        3000
4         Y          2         Open_Collector 0            10        3000
  Dummy Fan Links IGNORED   Daily Fan Run DISABLED   PWM Frequency 2 kHz
Type "1" to "4" to select Fan or Space to exit without changing
Type "d" to change Dummy Fan Links allowed/ignored setting
Type "r" to change Fan Daily Run setting
Type "f" to change PWM Frequency setting (ADVANCED)
Type Space to exit without changing
  
```

Type "1" for Fan 1 Configuration menu, display will be as shown:

```

----- FAN CHARACTERISTICS -----
Fan      Used      Pulses/   Control      Stationary    Ramp    Data Sheet
          Rev.      Type       PWM%         Rate          Max Fan RPM
1         Y          2         Open_Collector 0            10        3000
          1          2          3            4            5          6 <<< Menu Item Number

1:Change Used (Fan Present)
2:Change Pulses/Rev. (Tachometer Pulses per Fan Revolution)
3:Change Control Type (PWM level 0-10V or Open Collector)
4:Change Stationary PWM (PWM level to stop Fan rotating)
5:Change Ramp Rate (The rate at which the fan speed changes)
6:Change Fan Maximum RPM (As stated in fan Data Sheet. Note - this is NOT the set speed)
7:Copy this configuration to another fan
  Press SPACE to exit
  
```

Type "1" to toggle the "Fan Used" setting, display will be as shown:  
 Setting a fan to "Not Used" will inhibit spurious alarm generation for unfitted fans.

```

----- FAN CHARACTERISTICS -----
Fan      Used      Pulses/   Control      Stationary    Ramp    Data Sheet
          Rev.      Type       PWM%         Rate          Max Fan RPM
1         N          2         Open_Collector 0            10        3000
          1          2          3            4            5          6 <<< Menu Item Number
  
```

Type "2" to change the "Pulses/Rev" setting, display will be as shown:  
**The pulses/rev must be set correctly in order for the TMS to be able measure the Fan RPM. Consult Fan data sheet.**

Set the "Pulses/Rev" to zero if there is no open collector Tachometer output from the device being controlled or it is a Relay Alarm type fan (Open Loop control modes only).

```

Fan 1, Pulses (Tachometer Pulses per Fan Revolution) Current setting = 2
Select 0 if no Tachometer
Enter new value or SPACE to exit without changing
Enter a value between 0 and 9
  
```

Type e.g. “6” to change the “Pulses/Rev” setting to 6 pulses/rev (as for some S-Force fan types), display will be as shown:

```

----- FAN CHARACTERISTICS -----
Fan      Used      Pulses/  Control      Stationary    Ramp    Data Sheet
          Y        Rev.     Type          PWM%         Rate    Max Fan RPM
1         Y         6       Open_Collector  0            10     3000
          1         2         3             4            5         6 <<< Menu Item Number
  
```

Type “3” to toggle the “Control Type” setting, i.e. select PWM\_0\_10V for use with e.g. R1G175 type fan. Display will be as shown:

```

----- FAN CHARACTERISTICS -----
Fan      Used      Pulses/  Control      Stationary    Ramp    Data Sheet
          Y        Rev.     Type          PWM%         Rate    Max Fan RPM
1         Y         2       PWM_0_10V    0            10     3000
          1         2         3             4            5         6 <<< Menu Item Number
  
```

**IMPORTANT – Control Type setting must be correct for the fan being used.  
 If incorrectly set to Open Collector with 0-10V Fan then the fan will not run.  
 If incorrectly set to 0-10V with Open Collector fan then the fan input control voltage limit may be exceeded – fan damage risk.**

Type “4” to change the “Stationary PWM” setting, display will be as shown:

Fan 1, Stationary PWM (Speed Control signal level for Fan Stop) Current setting = 0  
 Enter new value or SPACE to exit without changing

Type e.g. “100” to change the “Stationary PWM” setting, this will have the effect of inverting the PWM output speed control profile. Consult fan data sheet for correct setting. Display will be as shown:

```

----- FAN CHARACTERISTICS -----
Fan      Used      Pulses/  Control      Stationary    Ramp    Data Sheet
          Y        Rev.     Type          PWM%         Rate    Max Fan RPM
1         Y         2       Open_Collector 100           10     3000
          1         2         3             4            5         6 <<< Menu Item Number
  
```

Type “5” to change the “Ramp Rate” setting, display will be as shown:

Fan 1, Ramp Rate (The rate at which the fan speed changes) Current setting = 10  
 Decrease the setting if the fan speed overshoots, increase for faster response  
 Enter new value between 1 and 100 or SPACE to exit without changing.

Type e.g. “20” as the new “Ramp Rate”, display will be as shown:

```

----- FAN CHARACTERISTICS -----
Fan      Used      Pulses/  Control      Stationary    Ramp    Data Sheet
          Y        Rev.     Type          PWM%         Rate    Max Fan RPM
1         Y         2       Open_Collector 100           20     3000
          1         2         3             4            5         6 <<< Menu Item Number
  
```

For Open Loop modes only, Type “6” to change the “Fan Maximum RPM” (As stated in fan Data Sheet). Note: the fan run speed set by the TMS will be determined by the Temperature Profile and Alarm configurations. The display will be as shown:

Fan 1, Fan Maximum RPM as shown in Fan Data Sheet, Current setting = 3000  
 Used to check Fan working

Enter new Maximum RPM or Select 0 if no Tachometer or SPACE to exit without changing

Type e.g. “10000” to change the “Fan Maximum RPM”, display will be as shown:



```

----- FAN CHARACTERISTICS -----
Fan      Used      Pulses/  Control  Stationary  Ramp  Data Sheet
          Rev.      Type      PWM%      Rate      Max Fan RPM
1        Y        2        Open_Collector  100      20      10000
          1        2        3        4        5        6 <<< Menu Item Number
    
```

Type "7" to copy this fan configuration to another fan, to avoid having to re-enter all parameters individually for each fan. Display will be as shown:

Enter number of fan to copy configuration to, or Space to exit without changing

Type e.g. "2" to copy this fan configuration to Fan 2, display will be as shown:

```

----- FAN CHARACTERISTICS -----
Fan      Used      Pulses/  Control  Stationary  Ramp  Data Sheet
          Rev.      Type      PWM%      Rate      Max Fan RPM
1        Y        6        Open_Collector  100      20      10000
2        Y        6        Open_Collector  100      20      10000
3        Y        2        Open_Collector  0        10      3000
4        Y        2        Open_Collector  0        10      3000
    
```

```

----- FAN CHARACTERISTICS -----
Fan      Used      Pulses/  Control  Stationary  Ramp  Data Sheet
          Rev.      Type      PWM%      Rate      Max Fan RPM
1        Y        6        Open_Collector  100      20      10000
          1        2        3        4        5        6 <<< Menu Item Number
    
```

Press [SPACE] to exit the Fan Configuration menu, the following menu will be shown:

```

Dummy Fan Links IGNORED      Daily Fan Run DISABLED      PWM Frequency 2 kHz
Type "1" to "4" to select Fan or Space to exit without changing
Type "d" to change Dummy Fan Links allowed/ignored setting
Type "r" to change Fan Daily Run setting
Type "f" to change PWM Frequency setting (ADVANCED)
Type Space to exit without changing
    
```

Press [d] to enable "Dummy fan links", the following will be shown:

```

Dummy Fan Links ALLOWED      Daily Fan Run DISABLED      PWM Frequency 2 kHz
Type "1" to "4" to select Fan or Space to exit without changing
Type "d" to change Dummy Fan Links allowed/ignored setting
Type "r" to change Fan Daily Run setting
Type "f" to change PWM Frequency setting (ADVANCED)
Type Space to exit without changing
    
```

Press [r] to enable "Fan Daily Run", the following will be shown:

```

Dummy Fan Links ALLOWED      Daily Fan Run ENABLED      PWM Frequency 2 kHz
Type "1" to "4" to select Fan or Space to exit without changing
Type "d" to change Dummy Fan Links allowed/ignored setting
Type "r" to change Fan Daily Run setting
Type "f" to change PWM Frequency setting (ADVANCED)
Type Space to exit without changing
    
```

Press [f] to change the "PWM frequency", the following will be shown:

```

PWM Frequency 2 kHz
    
```

```

Enter new value in the range 1 to 25
or SPACE to exit without changing
    
```

Type e.g. "25" to change the "PWM frequency" to 25kHz, display will be as shown:

```

Dummy Fan Links ALLOWED      Daily Fan Run ENABLED      PWM Frequency 25 kHz
Type "1" to "4" to select Fan or Space to exit without changing
Type "d" to change Dummy Fan Links allowed/ignored setting
Type "r" to change Fan Daily Run setting
Type "f" to change PWM Frequency setting (ADVANCED)
Type Space to exit without changing
    
```

### 16.3 Configuration of Temperature Profile

Set the temperature control profile as required for the particular customer application.

Type "t" for Temperature Profile Menu, display will be as shown for "Temperature sets Fan PWM" (Open Loop) Operating Mode.

For "Temperature sets RPM Output" (Closed Loop) mode, the RPM will be shown in place of percentage PWM.

Temperature Profile Menu

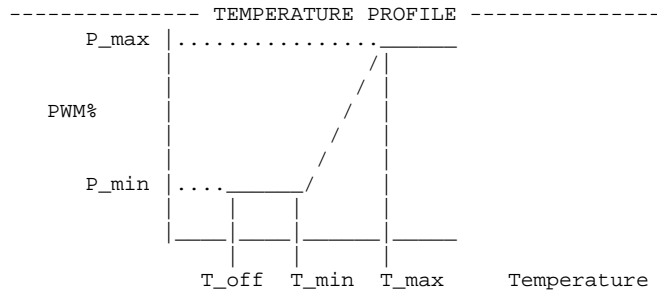

Fan	T_off	T_on	T_min	P_min	T_max	P_max	NTC
1	5	6	25	30	50	90	1
2	5	6	25	30	50	90	1
3	5	6	25	30	50	90	1
4	5	6	25	30	50	90	1

Type "1" to "4" to select Fan or Space to exit without changing  
 Type "m" to enable Multi Point Profile or Space to exit without changing

Type "1" for Fan 1 Temperature Profile menu, display will be as shown:

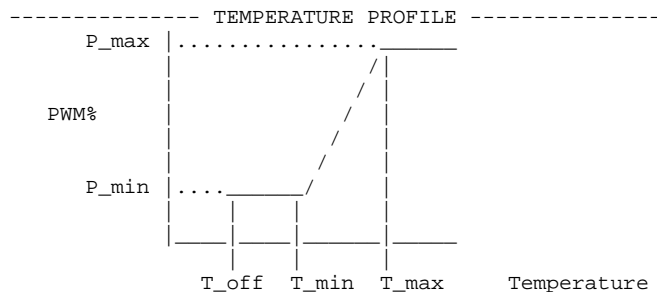

Fan	T_off	T_on	T_min	P_min	T_max	P_max	NTC
1	5	6	25	30	50	90	1
	1	2	3	4	5	6	7 8

<<< Menu Item Number

- 1:Change T\_off (Low Temperature Cut-Off)
  - 2:Change T\_on (Low Temperature Fan Start)
  - 3:Change T\_min (Bottom of Proportional Control Band)
  - 4:Change n\_min (PWM at Bottom of Proportional Control Band)
  - 5:Change T\_max (Top of Proportional Control Band)
  - 6:Change n\_max (PWM at Top of Proportional Control Band)
  - 7:Change NTC 1 (Thermistor 1 sets Fan Speed)
  - 8:Change NTC 2 (Thermistor 2 sets Fan Speed)
  - 9:Copy this configuration to another fan
- Press SPACE to exit

Type "1" for Low Temperature Fan Shut-Off menu, display will be as shown:

Fan 1, T\_off (Low Temperature Fan Stop) Current setting = 5C  
 Enter a value between -20 and 99  
 or "on" for Always On or SPACE to exit without changing

Type "on" to disable low temperature fan shut-off, so the fan runs continuously regardless of how low the temperature drops. Display will be as shown:

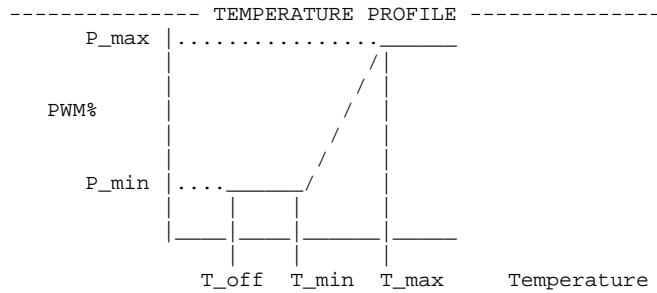

Fan	T_off	T_on	T_min	P_min	T_max	P_max	NTC
1	ON	ON	25	30	50	90	1
	1	2	3	4	5	6	7 8

<<< Menu Item Number

Type "2" to change the Fan Start temperature.

Type "3" to change the temperature at the Start of Proportional Control Band, display will be as shown:

Fan 1, Temperature Current setting = 25C  
 Enter new value or SPACE to exit without changing  
 Enter a value between -20 and 99

Type e.g. "35" to set the temperature at the Bottom of Proportional Control Band to 35C, display will be as shown:

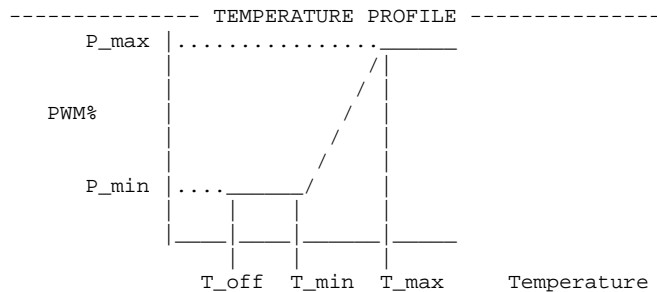

Fan	T_off	T_on	T_min	P_min	T_max	P_max	NTC
1	ON	ON	35	30	50	90	1
	1	2	3	4	5	6	7 8

<<< Menu Item Number

Type "4" to change the PWM Output at the Bottom of Proportional Control Band and below, display will be as shown:

Fan 1, Fan\_PWM Current setting = 30  
 Enter new value or SPACE to exit without changing  
 Enter a value between 0 and 100

Type e.g. "20" to set the PWM output at the Bottom of Proportional Control Band to 20%, display will be as shown:

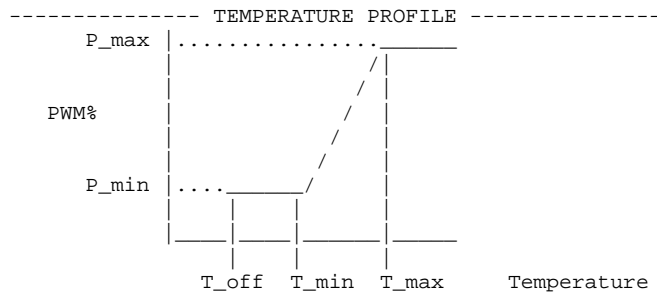

Fan	T_off	T_on	T_min	P_min	T_max	P_max	NTC
1	ON	ON	35	20	50	90	1
	1	2	3	4	5	6	7 8

<<< Menu Item Number

Type "5" to change the Temperature at the Top of Proportional Control Band, display will be as shown:

Fan 1, T\_max (Top of Proportional Control Band) Current setting = 50C  
 Enter new value or SPACE to exit without changing  
 Enter a value between -20 and 99

Type e.g. "45" to change the Temperature at the Top of Proportional Control Band to 45C, display will be as shown:

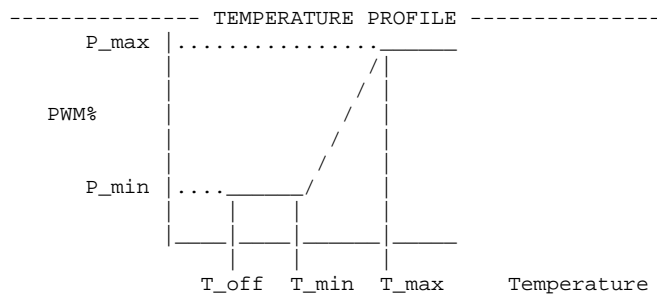

Fan	T_off	T_on	T_min	P_min	T_max	P_max	NTC
1	ON	ON	35	20	45	90	1
	1	2	3	4	5	6	7 8

<<< Menu Item Number

Type "6" to change the PWM Output at the Top of Proportional Control Band and above, display will be as shown:

Fan 1, Fan\_PWM Current setting = 90  
 Enter new value or SPACE to exit without changing  
 Enter a value between 0 and 100

Type e.g. "100" to set the PWM Output at the Top of Proportional Control Band to 100%, display will be as shown:

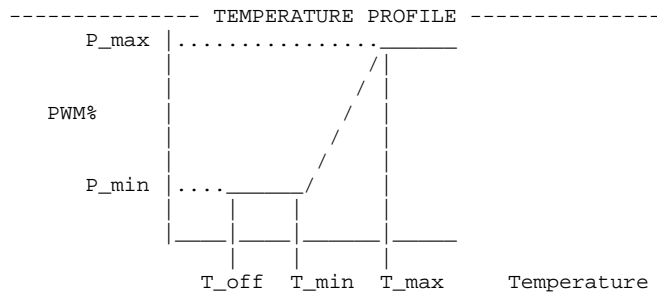

Fan	T_off	T_on	T_min	P_min	T_max	P_max	NTC
1	ON	ON	35	20	45	100	1
	1	2	3	4	5	6	7 8

<<< Menu Item Number

Type "8" to change the NTC Thermistor 2 used setting, if both thermistors selected then speed will be set by whichever of NTC Thermistor 1 or NTC Thermistor 2 is hottest. Display will be as shown:

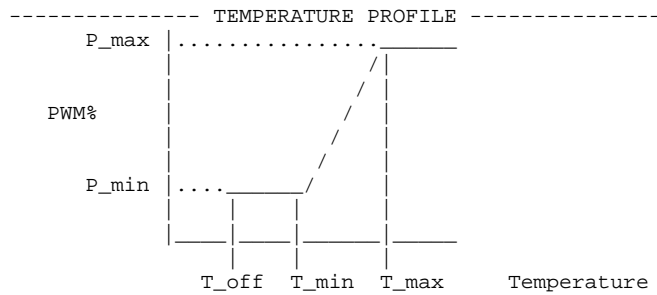

Fan	T_off	T_on	T_min	P_min	T_max	P_max	NTC
1	ON	ON	35	20	45	100	1^2
	1	2	3	4	5	6	7 8

<<< Menu Item Number

Type "7" to change the NTC Thermistor 1 used setting.

Display will be as shown:

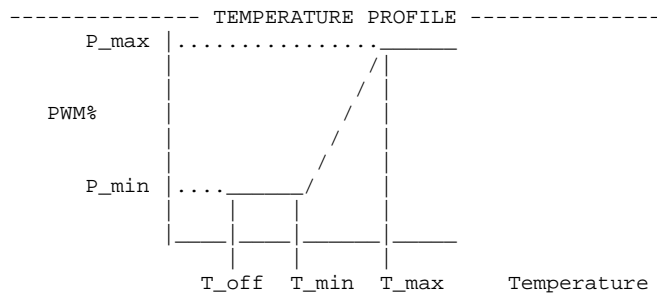

Fan	T_off	T_on	T_min	P_min	T_max	P_max	NTC
1	ON	ON	35	20	45	100	2
	1	2	3	4	5	6	7 8

<<< Menu Item Number

Type "9" to copy this configuration to another fan, to avoid having to re-enter all parameters individually for each fan.

Display will be as shown:

Enter number of fan to copy configuration to, or Space to exit without changing

Type e.g. "2" to copy this configuration to fan 2.

Display will be as shown:

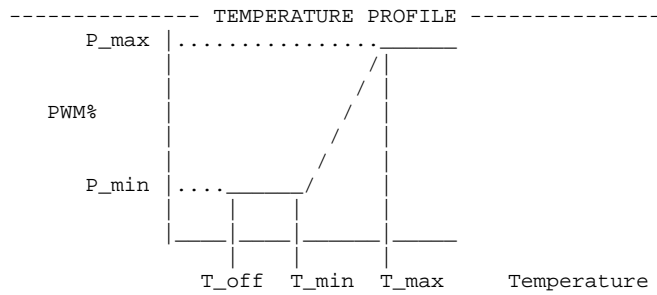

Fan	T_off	T_on	T_min	P_min	T_max	P_max	NTC
1	ON	ON	35	20	45	100	2
2	ON	ON	35	20	45	100	2
3	5	6	25	30	50	90	1
4	5	6	25	30	50	90	1

### 16.3.1 Multi-point Temperature Profile

From the Temperature Profile Menu, type "m" to enable Multi Point Profile, will enable configuration of interim points on the control profile as shown:

Temperature Profile Menu

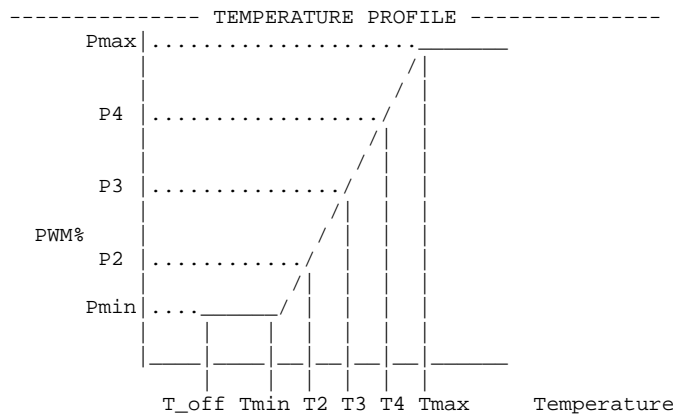

Fan	T_off	T_on	T_min	P_min	T2	P2	T3	P3	T4	P4	T_max	P_max	NTC
1	ON	ON	35	20	36	30	37	30	38	30	45	100	2
2	ON	ON	35	20	36	30	37	30	38	30	45	100	2
3	5	6	25	30	32	30	34	30	36	30	50	90	1
4	5	6	25	30	32	30	34	30	36	30	50	90	1

Type "1" to "4" to configure Temperature Profile or Space to exit without changing  
 Type "m" to disable Multi Point Profile or Space to exit without changing

Type "m" again to disable Multi Point Profile.

Set the extra control points as required using the multipoint configuration menu options a-f, see below:

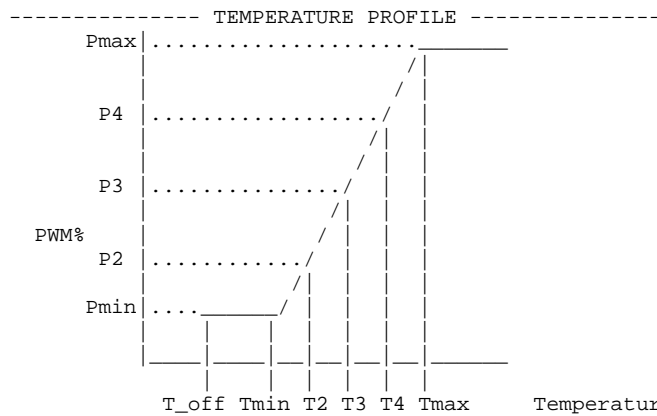

Fan	T_off	T_on	T_min	P_min	T2	P2	T3	P3	T4	P4	T_max	P_max	NTC
1	ON	ON	35	20	36	30	37	30	38	30	45	100	2
	1	2	3	4	a	b	c	d	e	f	5	6	7 8 <<<

- 1:Change T\_off (Low Temperature Cut-Off)
  - 2:Change T\_on (Low Temperature Fan Start)
  - 3:Change T\_min (Bottom of Proportional Control Band)
  - 4:Change n\_min (PWM at Bottom of Proportional Control Band)
  - a:Change T2 temperature
  - b:Change N2 (PWM at T2 temperature point)
  - c:Change T3 temperature
  - d:Change N3 (PWM at T3 temperature point)
  - e:Change T4 temperature
  - f:Change N4 (PWM at T4 temperature point)
  - 5:Change T\_max (Top of Proportional Control Band)
  - 6:Change n\_max (PWM at Top of Proportional Control Band)
  - 7:Change NTC 1 (Thermistor 1 sets Fan Speed)
  - 8:Change NTC 2 (Thermistor 2 sets Fan Speed)
  - 9:Copy this configuration to another fan
- Press SPACE to exit

### 16.3.2 Temperature Profile, Temperature sets RPM (closed loop) mode

Temperature Profile Menu

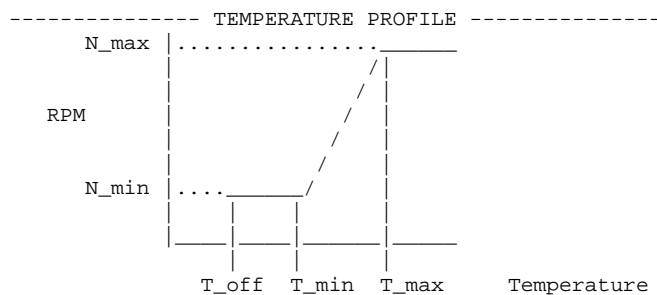

Fan	T_off	T_on	T_min	N_min	T_max	N_max	NTC
1	ON	ON	35	1000	45	3000	2
2	ON	ON	35	1000	45	3000	2
3	5	6	25	1000	50	3000	1
4	5	6	25	1000	50	3000	1

In this operating mode the Controller output sets the fan RPM (Closed Loop control). The fan speed control PWM output will be continuously adjusted to bring the measured fan RPM to the set value.

The setting shown for Fan1 would vary the speed from 1000 to 3000RPM over the temperature range 35C to 45C.

## 16.4 Alarm Configuration

Set the Alarm Configuration as required for the particular customer application.

Type "a" for Alarm Menu, display will be as shown

Alarm & Relay Configuration Menu

```

----- ANY ALARM CONDITION ----- -- RELAY & ALARM ACTION ---
      Input Input  Fan   NTC  Lo_temp Hi_Temp  Delta
Alarm  1    2    Bad   Bad   T1/T2  T1/T2  T1-T2  RELAY  /Fan1/Fan2/Fan3/Fan4/
1      ___ ___   ___   --   ___/___ ___/___   ___  OPEN  /___/___/___/___/
2      ___ ___   ___   --   ___/___ ___/___   ___  OPEN  /___/___/___/___/
3      ___ ___   ___   --   ___/___ ___/___   ___  OPEN  /___/___/___/___/
4      ___ ___   ___   --   ___/___ ___/___   ___  OPEN  /___/___/___/___/

```

Type "1" to "4" to select Alarm/Relay or Space to exit without changing  
 Type "p" to enable/disable Power Relay PCB or Space to exit without changing

Type "1" for Alarm 1 Menu, display will be as shown

```

----- ANY ALARM CONDITION ----- -- RELAY & ALARM ACTION ---
      Input Input  Fan   NTC  Lo_temp Hi_Temp  Delta
Alarm  1    2    Bad   Bad   T1/T2  T1/T2  T1-T2  RELAY  /Fan1/Fan2/Fan3/Fan4/
1      ___ ___   ___   --   ___/___ ___/___   ___  OPEN  /___/___/___/___/
      1    2    3    4 5    6 7    8 9    a    b    c    d    e    f    g

```

- ALARM CONDITIONS:
- 1:Change Input 1 (Switch Input 1 as an Alarm Condition)
  - 2:Change Input 2 (Switch Input 2 as an Alarm Condition)
  - 3:Change Fan Bad (Any Fan Fail as an Alarm Condition)
  - 4:Change NTC 1 Bad (Thermistor 1 Fail as an Alarm Condition)
  - 5:Change NTC 2 Bad (Thermistor 2 Fail as an Alarm Condition)
  - 6:Change NTC 1 Low limit (temperature T1 below this limit as an Alarm Condition)
  - 7:Change NTC 2 Low limit (temperature T2 below this limit as an Alarm Condition)
  - 8:Change NTC 1 High limit (temperature T1 above this limit as an Alarm Condition)
  - 9:Change NTC 2 High limit (temperature T2 above this limit as an Alarm Condition)
  - a:Change Delta T1-T2 (Difference between Temperature 1 and Temperature 2 as an Alarm Condition)
- ALARM ACTIONS:
- b:Change Alarm Relay action (select Contacts Open for Alarm or Contacts Closed for Alarm)
  - c:Change Fan 1 RPM alarm action (Fan set to this RPM if any specified alarm occurs)
  - d:Change Fan 2 RPM alarm action (Fan set to this RPM if any specified alarm occurs)
  - e:Change Fan 3 RPM alarm action (Fan set to this RPM if any specified alarm occurs)
  - f:Change Fan 4 RPM alarm action (Fan set to this RPM if any specified alarm occurs)
  - g:Change All Fans RPM alarm action (Fans set to this RPM if any specified alarm occurs)
- Press SPACE to exit

The default setting shown indicates that all of the alarms are set to "ignored". With this setting the alarm will never be activated.

Note – Alarm 1 has highest priority, Alarm 2 next highest, etc.

Set the alarms as required for the application.

Notes:

- 1) The Switch inputs can be set to / ignored / Alarm when high / Alarm when low. The switch inputs are High when Open, and Low when Linked.
- 2) Fan Bad monitor. This is configured on a per-fan basis. Generally the alarm will be configured to monitor all used fans together, but if the fans were configured to operate in pairs, e.g. if fans 1 & 2 operate together and fans 3 & 4 operate together, then fan 1 fail could be used to set fan 2 to full speed but fan 3 or 4 fail could be configured to be ignored for that alarm.
- 3) NTC Thermistor fail alarm would typically be configured such that failure of the Thermistor used to vary the speed of a fan would set that fan to full speed.
- 4) NTC Thermistor over-temperature or under-temperature could typically be used to generate an external alarm by means of a Relay.
- 5) Delta T1-T2 (Difference between Temperature 1 and Temperature 2 as an Alarm Condition). An alarm will be raised if T2 plus this value exceeds T1. This may be able to be used as a "blocked filter detect", dependant on the system configuration. Alternatively this may be used as an Intake Fan Shutoff Control, used for example when an equipment cabinet external temperature exceeds the internal temperature.



For maximum controller flexibility it is permitted to enter a negative value. This is equivalent to swapping the T1 and T2 inputs for the Delta T1-T2 alarm.

- 6) Alarm Relay action (select either Contacts Open for Alarm or Contacts Closed for Alarm) would normally be set to "Open" so that the contacts open in the case of alarm becoming active. The reason is that the contacts would also open in the event of a power failure thus generating an alarm, which is generally the desired action (fail safe).
- 7) Alarm Fan Speed setting would typically be used to increase the speed of the remaining fans in the event of a fan failure. **While an alarm is active the Alarm Fan Speed setting overrides the Temperature Profile Fan Speed setting.**

### 16.4.1 Alarm Configuration Example 1

Example Alarm Configuration,

Alarm & Relay Configuration Menu

----- ANY ALARM CONDITION -----								-- RELAY & ALARM ACTION ---					
Alarm	Input 1	Input 2	Fan Bad	NTC Bad	Lo_temp T1/T2	Hi_Temp T1/T2	Delta T1-T2	RELAY	FAN_PWM%				
1	_____	_____	1234	1	___/___	55/___	___	OPEN	/	100/	100/	100/	100/
2	_____	_____	_____	---	___/___	50/___	___	OPEN	/	___/	___/	___/	___/
3	_____	_____	_____	---	___/___	___/___	___	OPEN	/	___/	___/	___/	___/
4	_____	_____	_____	---	___/___	___/___	___	OPEN	/	___/	___/	___/	___/

For this example the Alarm1 will behave as follows:

The alarm will become active if any of the following events take place:

- 1) Fan 1 fail
- 2) Fan 2 fail
- 3) Fan 3 fail
- 4) Fan 4 fail
- 5) NTC Thermistor 1 Fail
- 6) NTC Thermistor 1 measured temperature 55C or above

The Alarm Actions listed below will all occur if the alarm becomes active

- 1) Alarm relay 1 contacts Open
- 2) Fan 1 set to 100% PWM.
- 3) Fan 2 set to 100% PWM.
- 4) Fan 3 set to 100% PWM.
- 5) Fan 4 set to 100% PWM.

Alarm2 will be active (Relay 2 will Open) if the NTC Thermistor 2 temperature exceeds 50C. Alarm2 will not affect any fan speed.

### 16.4.2 Alarm Configuration Example 2

Example Alarm Configuration

----- ANY ALARM CONDITION -----								-- RELAY & ALARM ACTION ---					
Alarm	Input 1	Input 2	Fan Bad	NTC Bad	Lo_temp T1/T2	Hi_Temp T1/T2	Delta T1-T2	RELAY	FAN_PWM%				
1	_____	_____	_____	---	___/___	___/___	___	OPEN	/	___/	___/	___/	___/
2	_____	_____	12	1 2	___/___	50/55	___	CLOSE	/	95	/90	/85	/80
3	_____	_____	_____	---	___/___	___/___	___	OPEN	/	___/	___/	___/	___/
4	_____	_____	_____	---	___/___	___/___	___	OPEN	/	___/	___/	___/	___/

For this example the alarm will behave as follows:

Alarm 2 will become active if any of the following events take place:

- 1) Fan 1 Fail
- 2) Fan 2 Fail
- 3) (Note – Fan 3 ignored for this alarm)
- 4) (Note – Fan 4 ignored for this alarm)
- 5) NTC Thermistor 1 Fail

- 6) NTC Thermistor 2 Fail
- 7) NTC Thermistor 1 measured temperature 50C or above
- 8) NTC Thermistor 2 measured temperature 55C or above

The Alarm Actions listed below will all occur if the alarm becomes active

- 1) Alarm relay 2 contacts Close (Open for No Alarm)
- 2) Fan 1 set to 95% of maximum speed.
- 3) Fan 2 set to 90% of maximum speed.
- 4) Fan 3 set to 85% of maximum speed.
- 5) Fan 4 set to 80% of maximum speed.

### 16.4.3 Relay Daughterboard [PROVISIONAL]

From the Alarm menu, type "p" to enable/disable Power Relay daughterboard PCB.

If not present or not operating correctly the Expansion Alarm LED will illuminate.

Once enabled the relays can be configured to operate in the same way as relays 1-4 on the TMS main PCB, see instructions above.

Node – the Daughterboard Relays default setting is:

Alarm Inactive = relay de-energised, contacts open

Alarm Active = relay energised, contacts closed

----- ANY ALARM CONDITION -----								-- RELAY & ALARM ACTION ---						
Alarm	Input 1	Input 2	Fan Bad	NTC Bad	Lo_temp T1/T2	Hi_Temp T1/T2	Delta T1-T2	RELAY	FAN_PWM%					
1	_____	_____	_____	---	___/___	___/___	---	OPEN	/	___/___	/	___/___	/	___/___
2	_____	_____	_____	---	___/___	___/___	---	OPEN	/	___/___	/	___/___	/	___/___
3	_____	_____	_____	---	___/___	___/___	---	OPEN	/	___/___	/	___/___	/	___/___
4	_____	_____	_____	---	___/___	___/___	---	OPEN	/	___/___	/	___/___	/	___/___
POWER RELAYS on external Power Relay PCB														
5	_____	_____	_____	---	___/___	___/___	---	CLOSE	/	___/___	/	___/___	/	___/___
6	_____	_____	_____	---	___/___	___/___	---	CLOSE	/	___/___	/	___/___	/	___/___

#### The Expansion Board Alarm LED operates as follows:

- 1) If there is no Daughterboard enabled AND no Daughterboard fitted/responding then no Fault so Alarm LED OFF
- 2) If there is a Daughterboard enabled AND Daughterboard fitted/responding then no Fault so Alarm LED OFF
- 3) If there is Daughterboard enabled BUT no Daughterboard fitted/responding then Fault so Alarm LED ON
- 4) If there is no Daughterboard enabled BUT Daughterboard IS fitted/responding then Fault so Alarm LED ON
- 5) If an incorrect voltage Daughterboard is connected (e.g. 24V Daughterboard, 48V supply) then Fault so Alarm LED ON

For correct Power Relay daughterboard operation the green LED on the daughterboard will pulse in sync with the green power LED on the TMS.

## 16.5 Configuration File Menu (Load, Save, etc.)

Type "c" for Configuration File Menu, display will be as shown

```
----- Configuration File Menu -----  
  
CONFIGURATION FILE =   MODIFIED  
  
Comment: Comment  
Date:dd/mm/yyyy  
  
CALCULATING Configuration Checksum ... PLEASE WAIT ... A562  
"r" to Read configuration file from PC  
"s" to Save configuration file to PC  
"p" to set the configuration file Part Number  
"i" to set the configuration file Issue Number  
"c" to change the Comment  
"d" to set the Date  
"x" to restore configuration to Factory Default  
"z" to Restart Program  
Space to exit
```

Note that there is a few seconds delay while the TMS calculates the checksum.  
The value of the checksum is configuration dependant.

### 16.5.1 To read (load) an existing configuration file from the PC

To read (load) an existing configuration file from the PC to the TMS, proceed as follows:

On the TeraTerm drop down menu select "File, Send file..."

Select the configuration file, it will be sent out on the serial interface to the TMS. Display will be as shown below (checksum for the file and CONFIGURATION FILE part / issue numbers are file dependant)

```
*** CONFIGURATION FILE RECEIVED ***  
  
Checking file, please wait ...  
Checksum Calc=A558 Embedded=A558 v.2, file Checksum correct.  
Programming Configuration, please wait ... Programming completed.  
Checking programming, please wait ...  
  
*****  
*** PROGRAMMING SUCCESSFUL ***  
*** 950-PRG12418 Iss.1 ***  
*****  
  
Comment: Comment: File_name_and_short_description  
Date:10May2012  
  
press any key to continue
```

#### Notes

- 1) The part number, issue, comment and date are as set by the user.
- 2) The checksum value is configuration dependant.
- 3) The configuration file part number and checksum can be read at any time to ensure that the configuration is as intended.

## 16.5.2 To save (write) an existing configuration file to the PC

To save (write) an existing configuration file to the PC, proceed as follows:

Notes:

- 1) It is recommended that the configuration file Part Number, configuration file Issue Number, configuration file Comment field and configuration file Date are set to meaningful values first.
- 2) Set the configuration file Issue Number last. Changing any other setting will change the configuration file Issue Number to “modified”.

Type “s” for Save configuration file to PC, display will be as shown:

```
Configure PC to save text to a file
or select text from START to END and save to file manually
Type "s" to send file to PC or Space to exit.
```

The PC can be set to save the configuration by opening a log file which is then saved. To do this, choose Log... from the TeraTerm File menu, type in a file name in the resulting dialogue box and select the location in which to save it. Anything that appears on the screen after this will be recorded in the file.

When ready, type “s” for Save configuration file to PC, display will be as shown (data will vary dependant on configuration file contents):

Please wait, calculating checksum ...

```
START <
000100010001000103E803E803E803E80BB80BB80BB8
0BB8FFFFFFFFFFFFFFFF001E001E001E001E00320032
0032003200020002000200020002000F000F000F000F0001
0001000000000000000000000000100010011001100110011
0000000000000000000000000000000000FF55FF55FF55
FF55FF55FF55FF55FF55FF55FF55FF55FF55FF55FF55FF55
FF55FF55FF55FF55FF55FF55FF55FF55FF55FF55FF55FF55
FF55FF55FF55FF55FF55FF55FF55FF55FF55FF55FF55FF55
FF55FF55FF55FF55FF55FF55FF55FF55FF55FF55FF55FF55
FF55FF55FF55FF55FF55FF55FF55FF55FF55FF55FF55FF55
FF55FF55FF55FF55FF55FF55FF55FF550000000000
0000000000010001FF55FF55FF55FF55FF55FF55FF55FF55
FF55FF55FF55FF55FF55FF55FF55FF55FF55FF55FF55FF55
FF55FF55FF55FF55FF55FF55FFFFFFFFFFFFFFFFFFFFFFF
FFFFFFFFFFFFFFFFFFFFFFFFFFFFFFFFFFFFFFFFFFFFFFFFFFFF
FFFFFFFFFFFFFFFFFFFFFFFFFFFFFFFF0000004400450046
00410055004C00540020002000200020002000200020FFFF
00000043006F006D006D0065006E00740020002000200020
002000200020002000200020002000200020002000200020
002000200020002000200020002000200020002000200020
002000200020002000200020002000200020002000200020
002000200020002000200020002000200020002000200020
0020002000200020FFFFFFFFFFF
FFFFFFFFFFFFFFFFFFFFFFFFFFFFFFFF
FFFFFFFFF00640064002F006D006D002F007900790079
0079FFFA55A
5A9D
> END
```

Press Space when finished saving file

If file logging has been started then to end recording, click on the Close button in the Log dialogue box (note that this box may be minimised to a button on the Windows task bar)

**Saving a configuration file on the PC, alternative to File Logging method:**

Copy the displayed text from the Terminal Emulator window and paste it into a new Text Editor document. Copy all text from START to END inclusive.

MS Notebook is a suitable text editor. MS Word is not.

From the text editor menu, save the file in the desired location, assigning it a meaningful name e.g. the configuration file part number & issue.

The configuration file may then be reloaded at a future date, or loaded onto other TMS units.

### **16.5.3 Set Default Configuration**

To set the configuration for all parameters to the factory default value, select option “x” from the Configuration File Menu.

Caution – once the key is pressed the action will be implemented without any further check.

### **16.5.4 Restart TMS Program**

To restart the TMS program, select option “z” from the Configuration File Menu. This is equivalent to power cycling the TMS. This may be useful if the TMS is being configured or monitored remotely, e.g. by means of a Remote Desktop Control program on the PC running the Terminal program.

Caution – once the key is pressed the action will be implemented without any further check.

### 17 Identification of Connectors, LED's and Pin Numbering

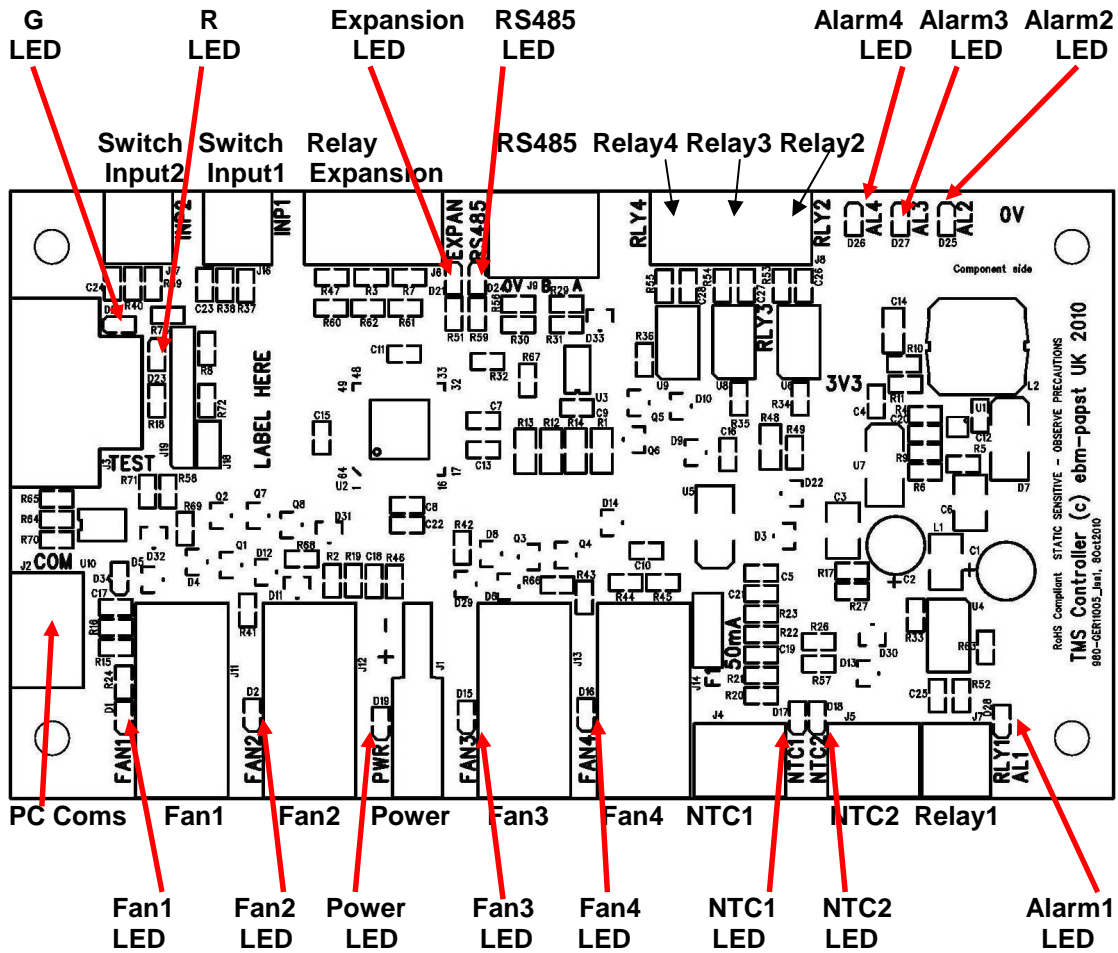

#### 17.1 Connectors, front edge of PCB, pin numbering

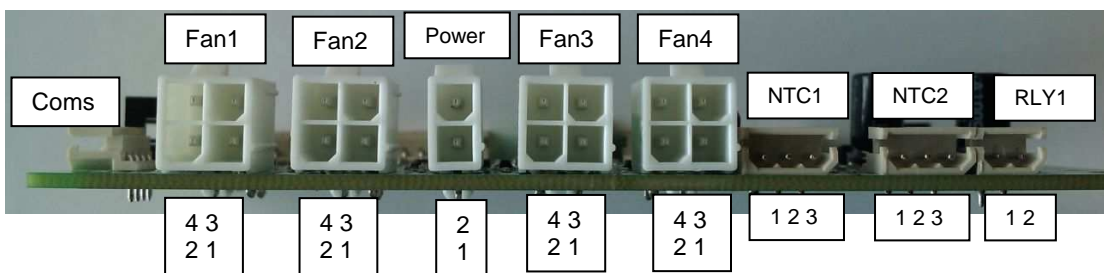

#### 17.2 Connectors, rear edge of PCB, pin numbering

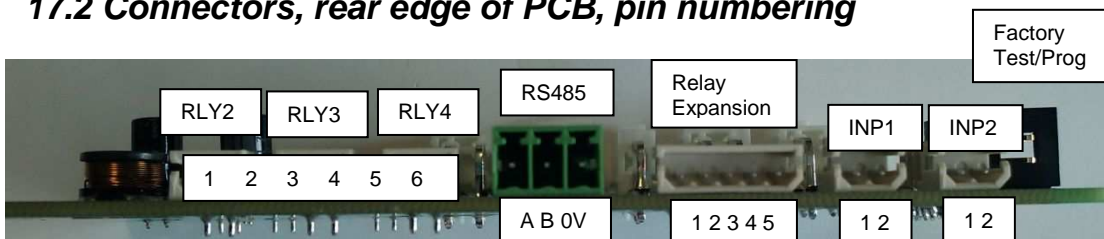

## **18 Mating Connector Types and Pin Configuration**

### **FRONT EDGE CONNECTIONS**

#### **Power Input**

Molex 39-01-2025, 4.20mm (.165") Pitch Mini-Fit Jr Receptacle Housing, Dual Row, UL 94V-0, 2 Circuits

Pin 1 = Positive supply +11 to +57V

Pin 2 = 0V

*(For -48V supplies see section "Use with -48VDC supply")*

#### **Fans**

Molex 39-01-2045, 4.20mm (.165") Pitch Mini-Fit Jr Receptacle Housing, Dual Row, UL 94V-0, 4 Circuits.

Pin 1 = 0V (connected to Power connector pin 2)

Pin 2 = +11 to +57V Out (connected to Power connector pin 1)

Pin 3 = PWM Output, Fan Speed Control

Pin 4 = Tachometer Input (For Relay Alarm fans connect relay between this pin and 0V)

#### **Crimps for Power and Fan Connectors**

Standard Crimp:

Molex 39-00-0039, 4.20mm (.165") Pitch Mini-Fit Crimp Terminal, Female, with Tin (Sn) over Copper (Cu) Plated Brass, 18-24 AWG, Bag. Up to 9A with 18AWG wire.

High Current Crimp:

Molex 0457503112, Mini-Fit Plus HCS Crimp Terminal 45750, 16 AWG, Bag, Copper (Cu) Alloy, Tin (Sn). Up to 11A with 16AWG wire.

#### **Thermistors and 0-10V Inputs**

Molex 50-37-5033 - CRIMP HOUSING, 2.5MM, 3WAY

##### **Thermistor connection**

Pin 1 = Thermistor terminal 1

Pin 2 = no connection

Pin 3 = Thermistor terminal 2

*(Thermistor has no polarity connection requirement)*

##### **Alternative connection for 0-10V input use**

for "0-10V Input" operating modes only:

Pin 1 = no connection

Pin 2 = 0V (connected to Power connector pin 2)

Pin 3 = 0-10V

##### **Relay Outputs, Relay 1**

Molex 50-37-5023 - CRIMP HOUSING, 2.5MM, 2WAY

Pin 1 = Relay 1 terminal 1

Pin 2 = Relay 1 terminal 2

**REAR EDGE CONNECTIONS****Relay Outputs, Relays 2-4**

Molex 50-37-5063 - CRIMP HOUSING, 2.5MM, 6WAY

Pin 1 = Relay 2 terminal 1  
Pin 2 = Relay 2 terminal 2  
Pin 3 = Relay 3 terminal 1  
Pin 4 = Relay 3 terminal 2  
Pin 5 = Relay 4 terminal 1  
Pin 6 = Relay 4 terminal 2

**Relay Expansion**

Molex 50375053 - CRIMP HOUSING, 2.5MM, 5WAY

Standard ebm-papst EC-Matrix compatible control interface pin-out, plus 12/24/48V Power.

**Switch Inputs 1-2**

Molex 50-37-5023 - CRIMP HOUSING, 2.5MM, 2WAY

Pin 1 = Switch input (Volt Free or Open Collector Compatible). On-board pull-up resistor.  
Pin 2 = 0V (connected to Power connector pin 2)

**Crimps for NTC Thermistors, Relay Outputs, Switch Inputs, Relay Daughterboard and Configuration Interface**

Molex 08-70-1040, 2.50mm (.098") Pitch SPOX™ Crimp Terminal 5263, 22-28 AWG, Bag

**RS485 Interface** *(Customer specific software use only.)*

IMO Precision Controls - 20.1550M/3 - Terminal Block, 3.5MM, 3WAY

Connections:

Pin A = RS485 A  
Pin B = RS485 B  
Pin 0V = 0V

**END CONNECTIONS****Coms - Configuration and Monitoring Interface**

Molex 50-37-5043 - CRIMP HOUSING, 2.5MM, 4WAY

Pin 1 = 5V input  
Pin 2 = Serial Out, 3V3 Logic level  
Pin 3 = Serial In, 3V3 Logic level  
Pin 4 = 0V

Connections are electrically isolated from TMS circuit.

Designed for connection of cable assembly ebm-papst part number 210-HAR11887

**Test Connector**

Factory use only. For reprogramming Microcontroller program.



## 19 Thermistors

NTC (Negative Temperature Coefficient) Thermistor, 100k Ohm at 25C. Thermistor manufacturer's part number Vishay 238164063104. Thermistor contacts must be insulated to prevent contact with chassis. The TMS is configurable to use either one or two thermistors. (Note – Thermistor type differs from HMS Controller).

### 19.1 Thermistor Cable Assembly Accessory

A thermistor cable assembly consists of a compatible insulated Thermistor, wired to Thermistor Connector pins 1 and 3.

Thermistor Cable Assembly Part Number	Cable Length mm
210-HAR12280	120
210-HAR12145	300
210-HAR12302	2000

## 20 Relay Daughterboard Accessory (PRELIMINARY)

An optional Relay Daughterboard may be connected to the Expansion Connector, relays controlled by the TMS controller.  
10A/250VAC relay contact rating.

There are 24V and 48V variants of the Relay daughterboard, dependant on the supply. When operating correctly, the Power LED on the Relay Daughterboard will pulse in time with the Power LED on the TMS.

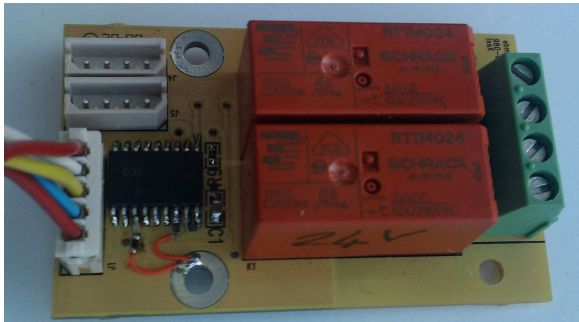

The interface used is compatible with the ebm-papst "EC Matrix" control bus, support for other EC-Matrix boards possible, contact ebm-papst.

Relay Daughterboard Part Number	TMS Supply Voltage
N/A	12V
980-CAS11659	24V
980-CAS11470	48V

## 21 Dummy Fan Link Accessory

Dummy Fan Link ebm-papst part number 210-HAR12141.

This comprises a fan connector with pins 3-4 linked (TMS PWM output linked to Tachometer Input).

## 22 Configuration Cable Assembly Accessory



ebm-papst part number 210-HAR11887, type A USB to TTL serial data adapter, length 1.8m. Connects TMS to PC for configuration and data logging.

## 23 Development Cable Set Accessory

Development Cable Set Accessory ebm-papst part number 210-HAR13100. This consists of a TMS power cable, 4 off fan cables, alarm cable and switch input cables. The cables consist of the required mating connector for the TMS connection, the other end of the cable being unterminated to allow the user to connect as they require. This is intended for development or evaluation use, particularly by customers that do not have tools to fit the necessary connector crimps. **Supports up to 7.5Amps total current.**

## 24 Fan Compatibility and example recommended settings

Four wire type fans (Power, 0V, Speed control, Tachometer/Alarm).

Fans may be a mix of 0-10V PWM type and Open Collector PWM speed controlled type.

PWM profile: The PWM output may be inverted, i.e. selectable between "PWM 0V out = fan off" and "PWM 0V out = fan full speed".

Tachometer - the number of pulses per revolution may be set for each fan, 1-6 pulses/rev, Open Collector compatible interface.

The TMS may also be used with mains powered EC Fans with 4 wire control connection (10V, 0-10V speed control, Open Collector Tachometer, 0v connection), provided that a 12-48V supply is provided for the TMS. Both the EC Fan 10V output and TMS Fan connector pin2 would be unused.

High current fans may be controlled (over 11A total current), route power directly to the fan.

All tachometer type fans to be controlled using "Temperature sets PWM Output (Open Loop)" or "0-10V input sets PWM Output (Open Loop)" modes must have an approximately linear internal control profile, i.e. 100% speed at 100% PWM, 50% speed at 50% PWM. Fans with an internal control profile that differs too far from this will generate spurious alarms.

This restriction does not apply to Relay Alarm type fans or when using the "Temperature sets Fan RPM (Closed Loop)" or "0-10V input sets Fan RPM" (Closed Loop)" modes.

### 24.1 Recommended Fan Settings

**Note: The following information is presented as a guide, in all cases the latest issue of the fan data sheet should be consulted.**

For ebm-papst St.Georgen fans only (identified by "St.Georgen" on the fan rating label), the Tachometer Pulses per Revolution may be determined by these rules :

- 1) Part numbers ending with the letter "O" always have three Tachometer Pulses per Revolution and are 0-10V control input. This rule overrides all other rules below.
- 2) Part numbers 4100 NH7 and NH8 e.g. 4114N/2HP8 have three Tachometer Pulses per Revolution.
- 3) All TD part numbers excluding 6400 TD have six Tachometer Pulses per Revolution.
- 4) All other St.Georgen fans have two pulses per revolution
- 5) Note - after 2012 consult the updated catalogue.

The speed control input is 0-10V for part numbers ending with the letter "O", others are Open Collector.

For ebm-papst Mulfingen fans (identified by "Mulfingen" on the fan rating label), the speed control input is normally 0-10V, Tachometer output either 1, 2 or 3 pulses / revolution.

Some example fan settings are shown in the table below. These fans have been tested and confirmed to be compatible with the TMS controller.

Failure to set configuration correctly can lead to spurious alarm generation and anomalous fan behaviour.

Fan Type	Voltage	Tachometer Pulses per Revolution	Maximum RPM setting	PWM Frequency kHz	Control Type 0-10V or Open Collector
2214F/2TDHHO	24	3	5000	2kHz	0-10V
2214F/2TDHO	24	3	4250	2kHz	0-10V
2218F/2TDH4P	48	6	6500	2kHz	Open Collector
2218F/2TDHHO	48	3	5000	2kHz	0-10V
3212J/2H4P	12	2	13000	2kHz	Open Collector
3214J/2H4P	24	2	13000	2kHz	Open Collector
3218J/2H4P	48	2	13000	2kHz	Open Collector
4114N/2H7P	48	3	9500	2kHz	Open Collector
4114N/2H8P	24	3	11000	2kHz	Open Collector
4118N/2H7P	24	3	9500	2kHz	Open Collector
4118N/2H8P	48	3	11000	2kHz	Open Collector
5312/2TDHP	12	6	6000	2kHz	Open Collector
5314/2TDHHP	24	6	7000	2kHz	Open Collector
5314/2TDHP	24	6	6000	2kHz	Open Collector
5318/2TDH4P	48	6	9200	2kHz	Open Collector
6312/2TDHP	12	6	5500	2kHz	Open Collector
6314/2TDHHP	24	6	7000	2kHz	Open Collector
6314/2TDHP	24	6	5500	2kHz	Open Collector
6318/2TDH4P	48	6	9200	2kHz	Open Collector
6318/2TDHHP	48	6	7000	2kHz	Open Collector
6318/2TDHP	48	6	5500	2kHz	Open Collector
8212J/2H4P	12	2	14000	2kHz	Open Collector
8214J/2H4P	24	2	14000	2kHz	Open Collector
8218J/2H4P	48	2	14000	2kHz	Open Collector
8412N/2GHP	12	2	3600	25kHz	Open Collector

8414N/2HP	24	2	3600	25kHz	Open Collector
G1G108-AB17-02	24	2	3000	2kHz	0-10V
R1G175-AF29-04	48	2	4000	2 kHz	0-10V
K1G190-AB25-02	48	2	2950	2 kHz	0-10V
RER175-42/18/2TDMP	48	6	4800	2 kHz	Open Collector
R1G310-AA33-52	48	3	1520	2 kHz	0-10V
D3G133-BF03-06	230VAC	1	1260	2kHz	0-10V

## 25 TMS / HMS Controller, summary of differences

The HMS controller was supplied by ebm-papst prior to the TMS becoming available. The following information is provided for customers who previously used the HMS controller.

- 1) TMS is supplied with Enclosure, DIN rail mountable with addition of clips.
- 2) TMS is smaller.
- 3) TMS is may be used with both 0-10V & Open Collector speed control fans.
- 4) TMS is compatible with both 0-10V & 10-0V (i.e. reversed speed control profile) fans.
- 5) Tachometer pulses per revolution limited to 1-3 on HMS, 1-6 on TMS, TMS compatible with ebm-papst S-Force fans.
- 6) TMS may be used with Relay Alarm or Open Collector alarm (no Tachometer) fans
- 7) TMS may be used with 12V fans (Open Collector Control)
- 8) TMS has programmable Alarm on difference between temperatures of Thermistor 1 & Thermistor 2.
- 9) TMS has Alarm Indicator LED's on board.
- 10) No proprietary PC configuration software required for TMS, uses standard Terminal software (lower obsolescence risk).
- 11) TMS configuration cable uses USB connection, HMS used RS232, ports 0-3 only (generally the HMS must be configured using a PC with built-in Serial Port, USB-RS232 Serial adapters not supported).
- 12) TMS accepts "Fan not fitted" dummy fan link in place of fan, customer can have e.g. 4 Fan s/w version programmed then fit number of fans as required without reprogramming / unwanted alarms.
- 13) TMS PWM frequency configurable.
- 14) TMS has "Daily Fan Run", configurable option.
- 15) TMS "Fan Fail" alarm action is configurable to monitor selected fans, HMS monitors all or none.
- 16) TMS has 0-10V input option
- 17) TMS has "File Logging" data output feature
- 18) TMS Thermistor type differs from HMS Controller.



**26 CE Certificate, copy of front sheet**



Part No - 980-CAS11007

0093

Certificate No - 980-CAS11007CE

CE DECLARATION OF CONFORMITY		
<b>Declaration</b>		
We, ebm-papst UK Ltd, Chelmsford Business Park, Chelmsford, Essex CM2 5EZ certify that the product(s) listed are in conformity with;		
Low Voltage Directive 2006/95/EC Electromagnetic Compatibility Directive 2004/108/EC		
	Declaration Approved	Technical File Compiled
Name	G. M. Lockwood	Jeff Elkins
Position	Technical Director	Electronics Design Engineer
Signature		
Date of Declaration	23-Jan-2011	23-Jan-2011
Part number:	980-CAS11007	
Description:	Fan speed controller and monitor, 48V DC	
<p>The product(s) have been assessed by the application of the following Standards;</p> <p>BS EN 60950-1 - Information technology equipment. Safety. General requirements</p> <p>BS EN61000-6-3:2007 (emissions)</p> <p>BS EN61000-6-2:2005 (immunity)</p> <p>Radiated Emissions BS EN55022:2006, Class B</p> <p>Radiated Immunity EN61000-4-3:2002 +A1+A2</p> <p>Fast Transient Bursts EN61000-4-4:2004</p> <p>Conducted Immunity EN61000-4-6:2007</p>		