

## Specifications

- Current rating:1A AC,DC
- Voltage rating:30V AC,DC
- Temperature range:-40°C~+105°C
- Contact resistance:30mΩMax.
- Insulation resistance:100MΩMin.
- Withstanding voltage:200V AC/minute
- \*Compliant with RoHS and REACH\*
- \*Meet the HF/Halogen Free,need to customize\*
- \*Contact CJT for details\*

Standards

## Assembly layout

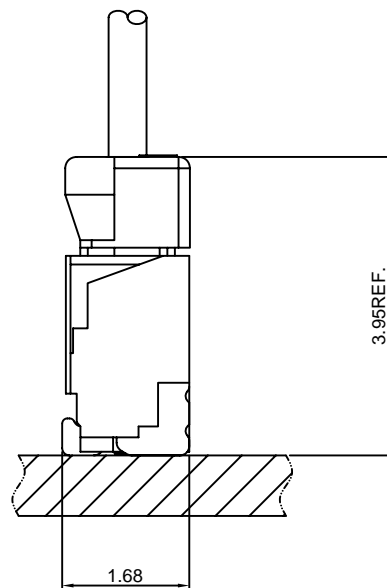
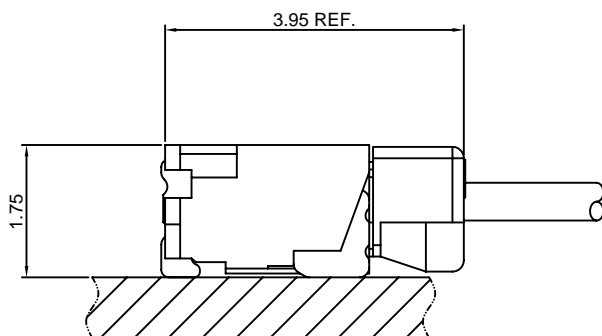

## A0801-T

0.80mm pitch Crimp Terminal

**Reference Informations:**

\*Used in CJT A0801H-XP, A0801H-XP-2 series Housing

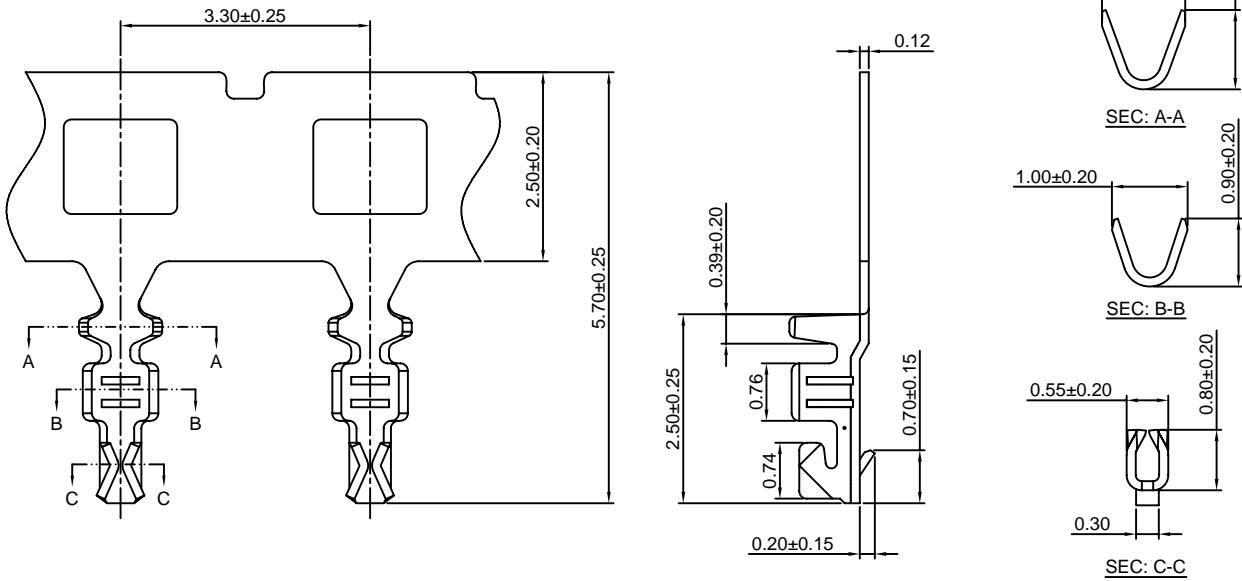

Ordering information & Specifications:

Unit:mm

Part NO.	Wire Range	Insulation O.D.	Material	Finish	Qty/reel
A0801-TP	AWG#28-#32	0.60mm(max)	Phosphor Bronze	Tin over Nickel	45,000 PCS
A0801-GP	AWG#28-#32	0.60mm(max)	Phosphor Bronze	Gold over flash	45,000 PCS

Optional Gold plating available but MOQ requested

## A0801H-XP

0.80mm pitch Housing

**Reference Informations:**

- \*Material:LCP,UL94V-0
- \*Suitable CJT A0801-T series Terminal
- \*Mates with CJT D0801WV-S,WR-S-XP series Wafer
- \*Color:Natural

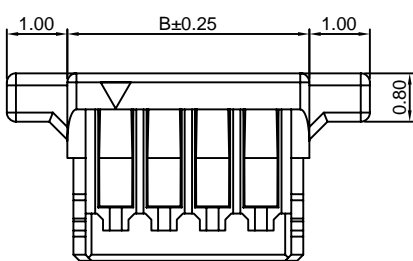
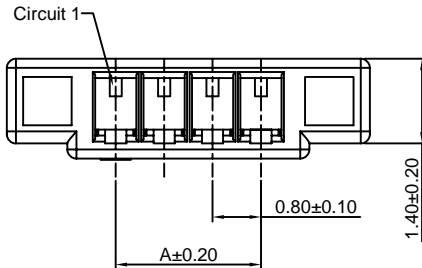

**Ordering Information:**

- A0801H-XP - \*\*\*  
 1 2  
 1.Part No.  
 2.Material:  
 (Blank):LCP,UL94V-0  
 GWT:LCP,UL94V-0,GWT 750°C

**Ordering Information & Dimensions:**

PART NO.	Dimensions	
	A	B
2P	0.80	2.40
3P	1.60	3.20
4P	2.40	4.00
5P	3.20	4.80
6P	4.00	5.60
7P	4.80	6.40
8P	5.60	7.20
9P	6.40	8.00
10P	7.20	8.80
11P	8.00	9.60
12P	8.80	10.40
13P	9.60	11.20
14P	10.40	12.00
15P	11.20	12.80
16P	12.00	13.60
17P	12.80	14.40
18P	13.60	15.20
19P	14.40	16.00
20P	15.20	16.80

Unit: mm



# A0801 SERIES

0.80mm pitch wire to board connector

## A0801H-XP-2

0.80mm pitch Housing

**Reference Informations:**

- \*Material:LCP,UL94V-0
- \*Suitable CJT A0801-T series Terminal
- \*Mates with CJT D0801WV-S,WR-S-XP series Wafer
- \*Color:Natural

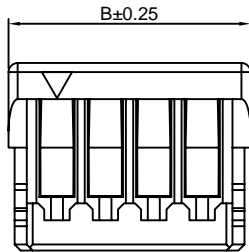
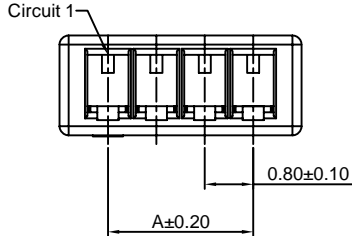

Ordering Information:  
A0801H-XP-2 - \*\*\*

- 1.Part No.  
2.Material:  
(Blank):LCP,UL94V-0  
GWT:LCP,UL94V-0,GWT 750℃

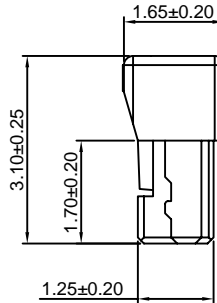

PART NO.	Dimensions	
	A	B
2P	0.80	2.40
3P	1.60	3.20
4P	2.40	4.00
5P	3.20	4.80
6P	4.00	5.60
7P	4.80	6.40
8P	5.60	7.20
9P	6.40	8.00
10P	7.20	8.80
11P	8.00	9.60
12P	8.80	10.40
13P	9.60	11.20
14P	10.40	12.00
15P	11.20	12.80
16P	12.00	13.60
17P	12.80	14.40
18P	13.60	15.20
19P	14.40	16.00
20P	15.20	16.80