

# EDLC 3.0V 100F



## FEATURES

- Electric double layer capacitor
- Higher power density with ultra low ESR
- Semi-permanent, quick charge and discharge than batteries
- Suitable for short-term peak power assistance application
- UL and ISO/TS certificated, RoHS compliant
- Radial design with 2-pin snap-in terminal type



## DIMENSIONS

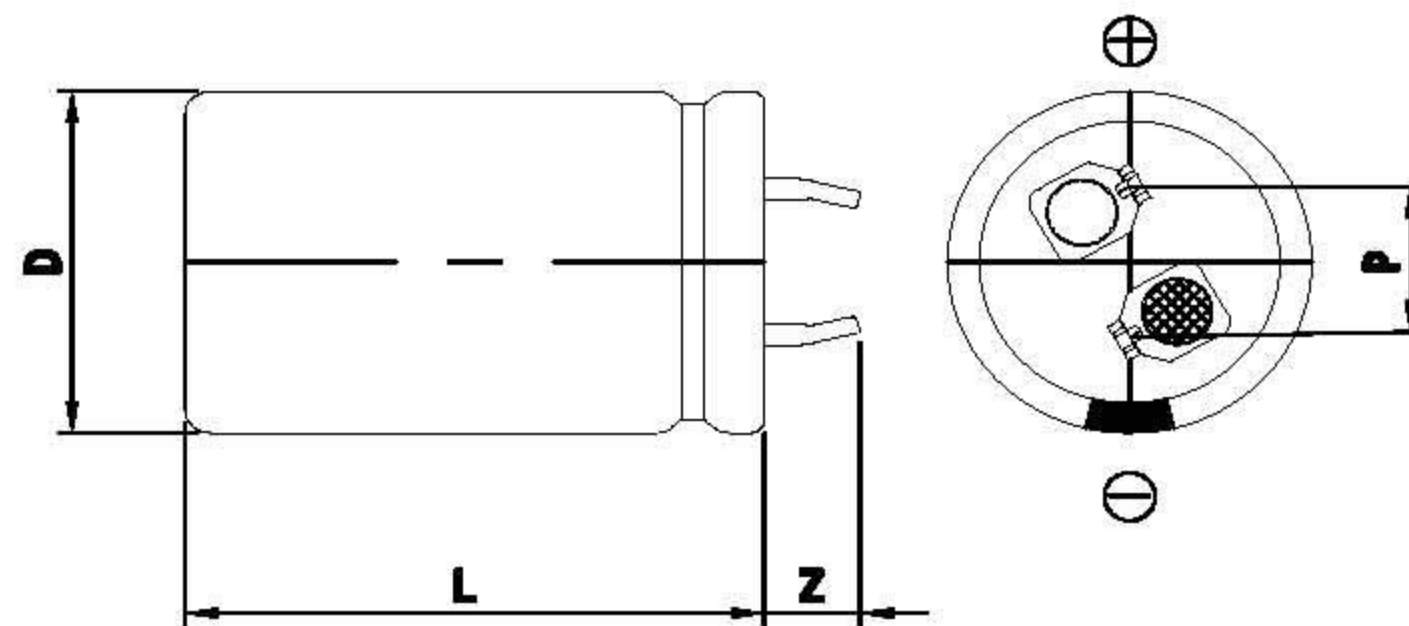

Dimensions in mm			
D +1.5 Max	L ± 2.0	Z ± 1.0	P ± 0.2
Φ22.0	45.0	6.0	10.0

This drawing is not to be scaled.

## SPECIFICATIONS

Part Number	Rated Voltage, $V_R$ (V)	Rated Capacitance (F)	AC ESR 1kHz (mΩ)	DC IR (mΩ)	Maximum Current (A)	Leakage Current (mA)	Stored Energy (J)	Dimension D x L (mm)	Weight (g)
VEC 3R0 107 QG	3.0	100.	6.00	10.00	75.	0.300	450.0	22.0 x 45.0	20.0

\* Maximum Current: 1 second discharge to  $\frac{1}{2} \cdot V_R$

\* Leakage Current: After 72hours at  $V_R$  and 25°C

Item	Characteristics	Remarks
Rated Voltage( $V_R$ )	3.0V	
Capacitance Tolerance	-10 ~ 30%	
Operating Temperature ( $T_{min} \sim T_{max}$ )	-40 ~ +65°C	$ \Delta cap  \leq 30\%$ of initial value at 25°C $ \Delta ESR  \leq 100\%$ of specified value at 25°C After 1,000 hours application of $V_R$ at $T_{max}$
Storage Temperature	-40 ~ 70°C	
Cycle Life	500,000 cycles	$ \Delta cap  \leq 30\%$ of initial value at 25°C $ \Delta ESR  \leq 100\%$ of specified value at 25°C Cycles from $V_R$ to $\frac{1}{2} \cdot V_R$ under constant current at 25°C
Shelf Life	2 years	$ \Delta cap  \leq 10\%$ of initial value at 25°C $ \Delta ESR  \leq 50\%$ of specified value at 25°C Without electrical charge under $T_{max}$