

Chip Beads(SMD) For Signal Line

Conformity to RoHS Directive

MMZ Series MMZ1608 Type

FEATURES

- Chip bead(impeder), MMZ series offers 6 construction materials.
- Size standardized for use by automatic assembly equipment. No preferred orientation.
- Either flow or reflow soldering methods can be used due to electroplating of the terminal electrodes.
- High reliability due to an entirely monolithic structure.
- Closed magnetic circuit structure allows high-density installation while preventing crosstalk between circuits.
- Low DC resistance structure of electrode prevents wasteful electric power consumption.
- The products contain no lead and also support lead-free soldering.
- It is a product conforming to RoHS directive.

APPLICATIONS

Personal computers, CRTs, liquid crystal display panels, printers, hard disk drives, game machines, cellular phones, etc.

PRODUCT IDENTIFICATION

MMZ	1608	R	121	A	T
(1)	(2)	(3)	(4)	(5)	(6)

- (1) Series name
 (2) Dimensions L×W
 (3) Material code
 (4) Nominal impedance
 121:120Ω at 100MHz
 (5) Characteristic type
 (6) Packaging style
 T:Taping

HANDLING AND PRECAUTIONS

- Before soldering, be sure to preheat components. The preheating temperature should be set so that the temperature difference between the solder temperature and product temperature does not exceed 150°C.
- After mounting components onto the printed circuit board, do not apply stress through board bending or mishandling.
- Do not expose the inductors to stray magnetic fields.
- Avoid static electricity discharge during handling.
- When hand soldering, apply the soldering iron to the printed circuit board only. Temperature of the iron tip should not exceed 350°C. Soldering time should not exceed 3 seconds.

MATERIAL CHARACTERISTICS

B material: This type is perfectly suited for fast digital signals. By equalizing R components and X components that beads possess at a frequency of 5MHz, it is able to suppress overshooting, undershooting and ringing of fast digital signals.

R material: For wide frequency applications calling for broad impedance characteristics.

For digital signal line applications calling requiring good waveform integrity. Impedance values selected for effectiveness at 10 to 200MHz.

S material: Standard type that features impedance characteristics similar to those of a typical ferrite core.

For signal line applications in which the blocking region is near 100MHz. Impedance values selected for effectiveness at 40 to 300MHz.

Y material: High frequency range type intended for the 100MHz region and above.

For signal line applications in which the signal frequency is far from the cutoff frequency. Impedance values selected for effectiveness at 80 to 400MHz.

A material: This high-impedance product is based on the impedance frequency characteristics of our Y-material. The product offers excellent impedance characteristics, which is greater than 2500Ω in the vicinity of 100MHz range (MMZ1608A252B).

D material: For applications calling for low insertion loss at low frequencies and sharply increasing impedance at high frequencies. Designed for high impedance at high frequencies (300MHz to 1GHz) for signal line applications.

TYPICAL MATERIAL CHARACTERISTICS

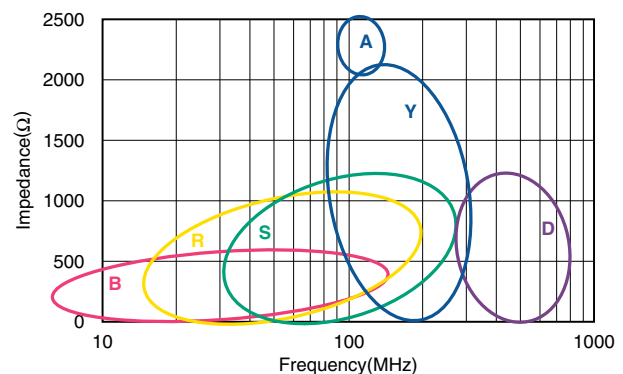

• Conformity to RoHS Directive: This means that, in conformity with EU Directive 2002/95/EC, lead, cadmium, mercury, hexavalent chromium, and specific bromine-based flame retardants, PBB and PBDE, have not been used, except for exempted applications.

• Please contact our Sales office when your application are considered the following:
 The device's failure or malfunction may directly endanger human life (e.g. application for automobile/aircraft/medical/nuclear power devices, etc.)

• All specifications are subject to change without notice.

SHAPES AND DIMENSIONS/RECOMMENDED PC BOARD PATTERN

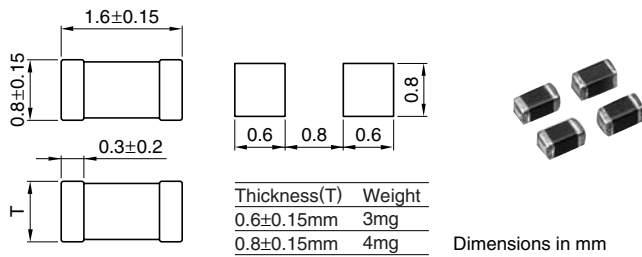

TEMPERATURE RANGES

Operating/storage	-55 to $+125^{\circ}\text{C}$
-------------------	---------------------------------

PACKAGING STYLE AND QUANTITIES

Packaging style	Quantity
Taping	4000 pieces/reel

RECOMMENDED SOLDERING CONDITION REFLOW SOLDERING

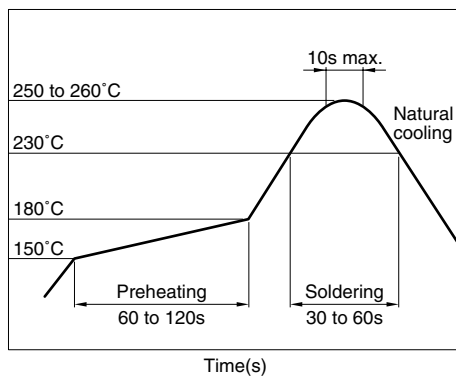

ELECTRICAL CHARACTERISTICS

Part No.	Impedance (Ω) [100MHz]*	DC resistance (Ω)max.	Rated current (mA)max.	Product's thickness T(mm)
MMZ1608B121C	$120 \pm 25\%$	0.15	600	0.6
MMZ1608B301C	$300 \pm 25\%$	0.25	500	0.6
MMZ1608B601C	$600 \pm 25\%$	0.4	500	0.6
MMZ1608R150A	$15 \pm 25\%$	0.05	1500	0.8
MMZ1608R300A	$30 \pm 25\%$	0.05	1500	0.8
MMZ1608R600A	$60 \pm 25\%$	0.1	800	0.8
MMZ1608R121A	$120 \pm 25\%$	0.18	500	0.8
MMZ1608R301A	$300 \pm 25\%$	0.25	500	0.8
MMZ1608R601A	$600 \pm 25\%$	0.4	500	0.8
MMZ1608R102A	$1000 \pm 25\%$	0.5	400	0.8
MMZ1608S400A	$40 \pm 25\%$	0.1	600	0.8
MMZ1608S800A	$80 \pm 25\%$	0.15	500	0.8
MMZ1608S121A	$120 \pm 25\%$	0.2	500	0.8
MMZ1608S181A	$180 \pm 25\%$	0.2	500	0.8
MMZ1608S301A	$300 \pm 25\%$	0.3	500	0.8
MMZ1608S601A	$600 \pm 25\%$	0.4	500	0.8
MMZ1608S102A	$1000 \pm 25\%$	0.5	400	0.8
MMZ1608Y150B	$15 \pm 25\%$	0.05	1500	0.8
MMZ1608Y300B	$30 \pm 25\%$	0.05	1500	0.8
MMZ1608Y600B	$60 \pm 25\%$	0.15	500	0.8
MMZ1608Y121B	$120 \pm 25\%$	0.2	500	0.8
MMZ1608Y301B	$300 \pm 25\%$	0.3	500	0.8
MMZ1608Y601B	$600 \pm 25\%$	0.4	500	0.8
MMZ1608Y102B	$1000 \pm 25\%$	0.5	400	0.8
MMZ1608Y152B	$1500 \pm 25\%$	0.6	300	0.8
MMZ1608A252B	$2500 \pm 25\%$	0.8	200	0.8
MMZ1608D050C	$5 \pm 2\Omega$	0.1	700	0.8
MMZ1608D100C	$10 \pm 5\Omega$	0.15	500	0.6
MMZ1608D220C	$22 \pm 25\%$	0.2	500	0.6
MMZ1608D500C	$50 \pm 25\%$	0.3	500	0.6
MMZ1608D800C	$80 \pm 25\%$	0.35	500	0.6
MMZ1608D800B	$80 \pm 25\%$	0.35	500	0.8
MMZ1608D121C	$120 \pm 25\%$	0.45	400	0.6
MMZ1608D121B	$120 \pm 25\%$	0.45	400	0.8
MMZ1608D241C	$240 \pm 25\%$	0.6	300	0.8
MMZ1608D301B	$300 \pm 25\%$	0.7	300	0.8

* Test equipment: E4991A or equivalent
 Test tool: 16192A or equivalent
 Test temperature: $25 \pm 10^{\circ}\text{C}$

TYPICAL ELECTRICAL CHARACTERISTICS

Z, X, R vs. FREQUENCY CHARACTERISTICS

MMZ1608B121C

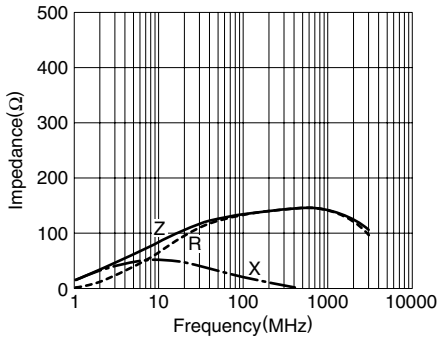

MMZ1608B301C

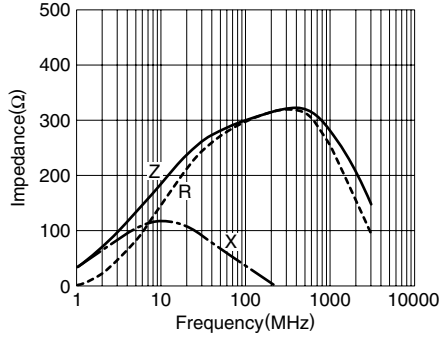

MMZ1608B601C

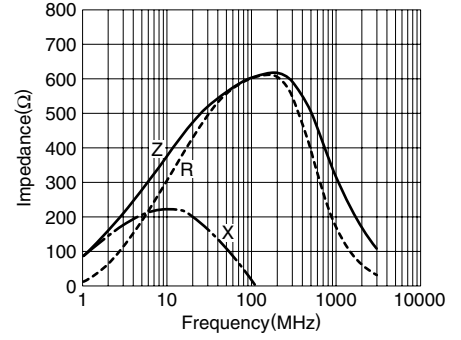

MMZ1608R150A

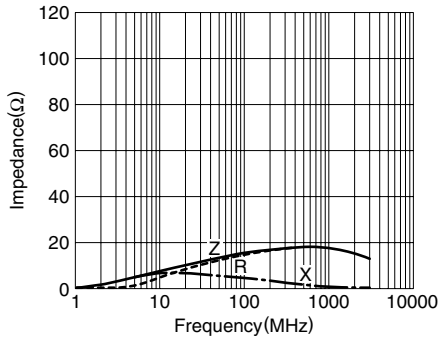

MMZ1608R300A

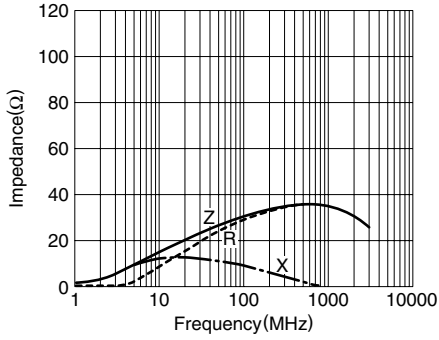

MMZ1608R600A

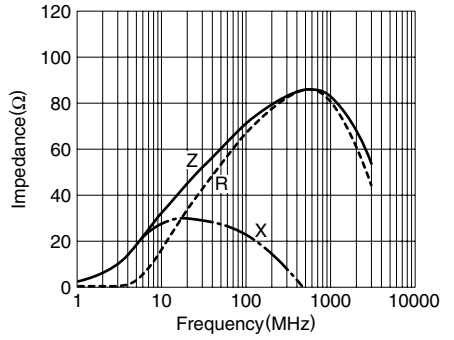

MMZ1608R121A

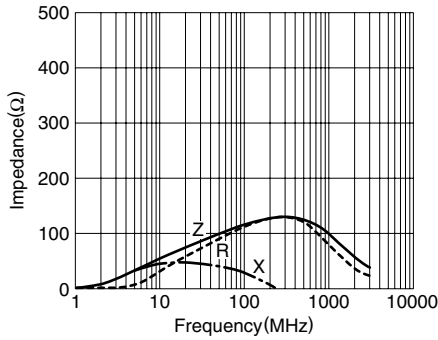

MMZ1608R301A

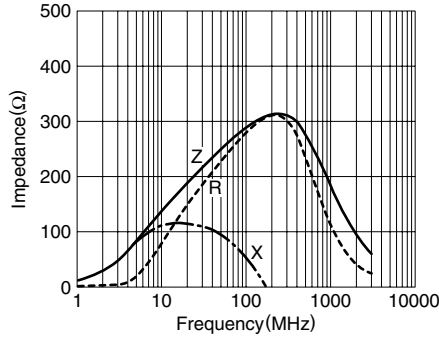

MMZ1608R601A

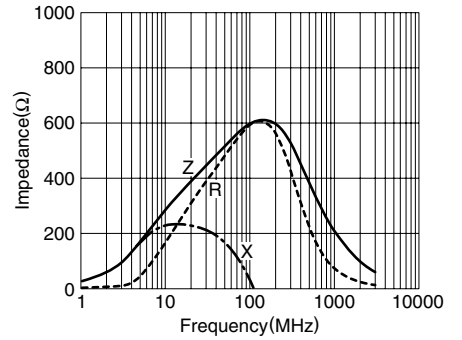

MMZ1608R102A

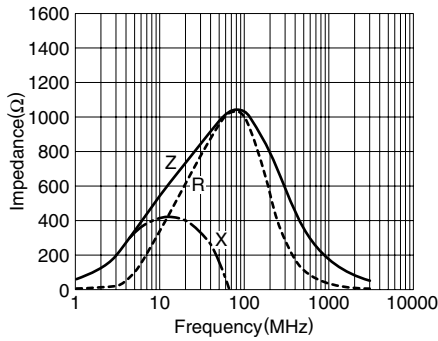

MMZ1608S400A

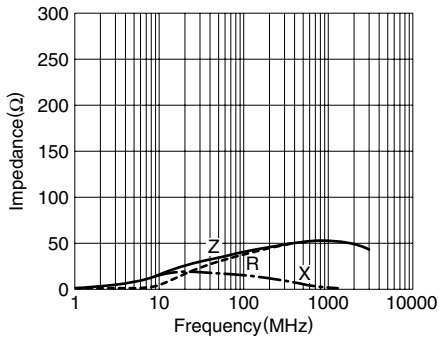

MMZ1608S800A

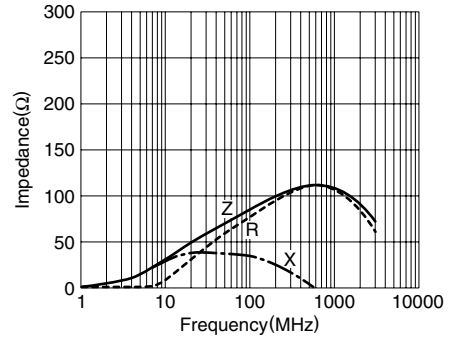

• All specifications are subject to change without notice.

TYPICAL ELECTRICAL CHARACTERISTICS

Z, X, R vs. FREQUENCY CHARACTERISTICS

MMZ1608S121A

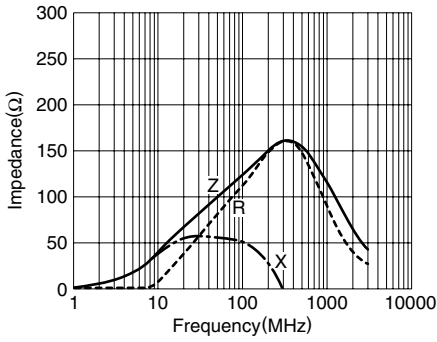

MMZ1608S181A

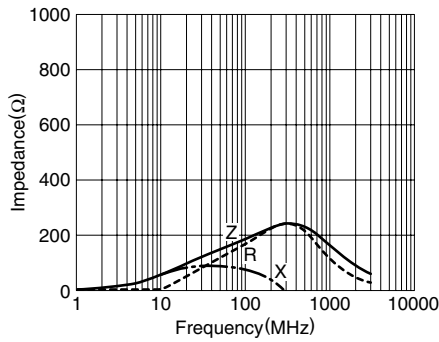

MMZ1608S301A

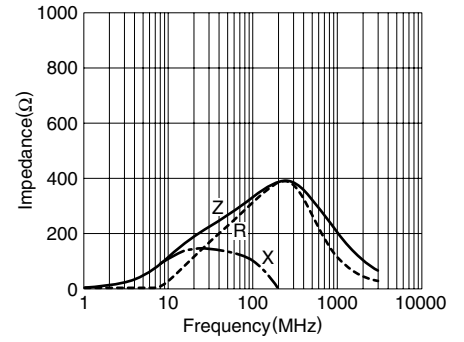

MMZ1608S601A

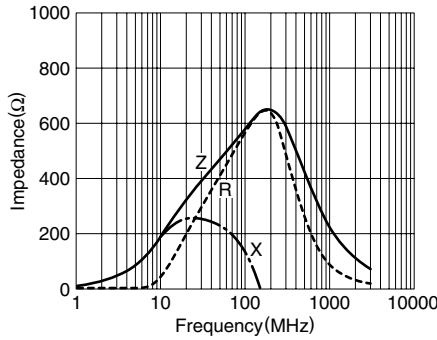

MMZ1608S102A

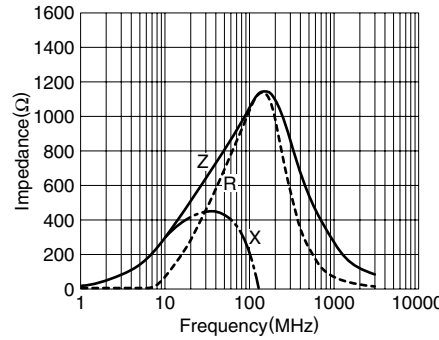

MMZ1608Y150B

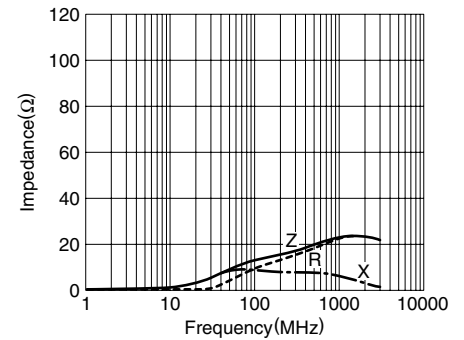

MMZ1608Y300B

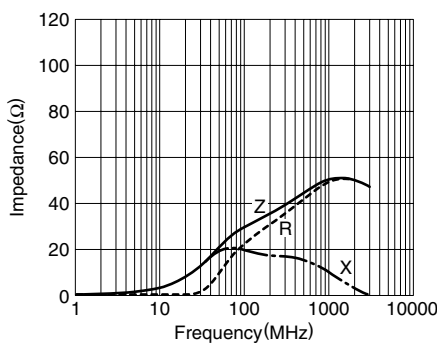

MMZ1608Y600B

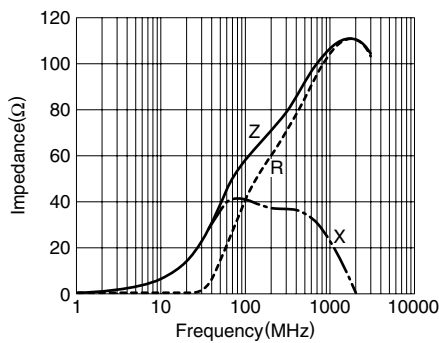

MMZ1608Y121B

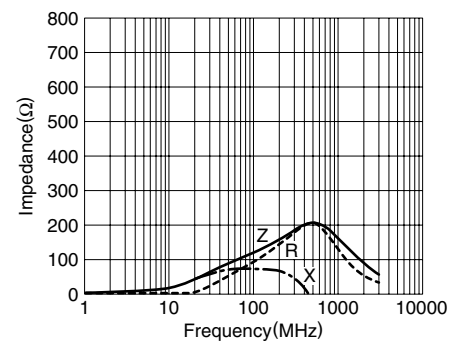

MMZ1608Y301B

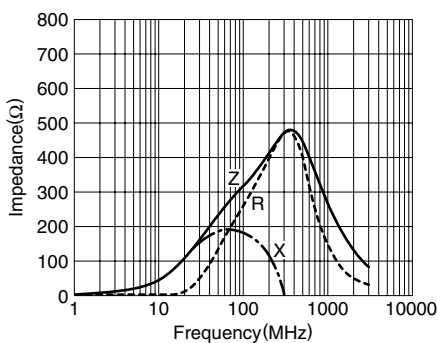

MMZ1608Y601B

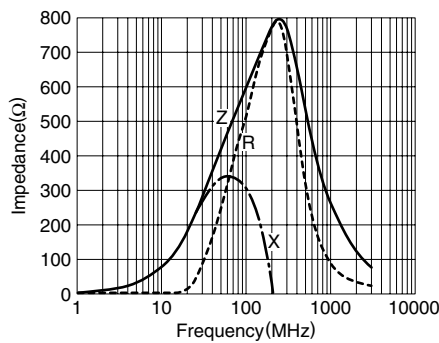

MMZ1608Y102B

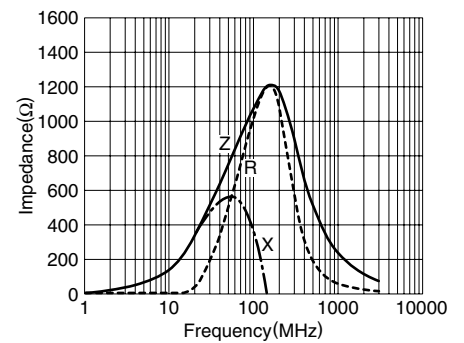

• All specifications are subject to change without notice.

TYPICAL ELECTRICAL CHARACTERISTICS

Z, X, R vs. FREQUENCY CHARACTERISTICS

MMZ1608Y152B

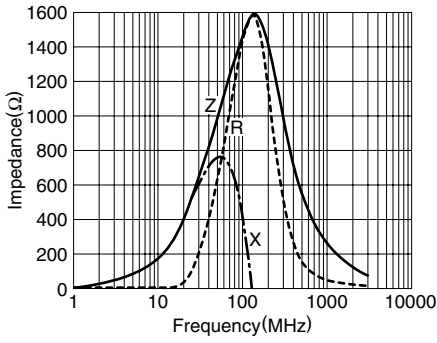

MMZ1608A252B

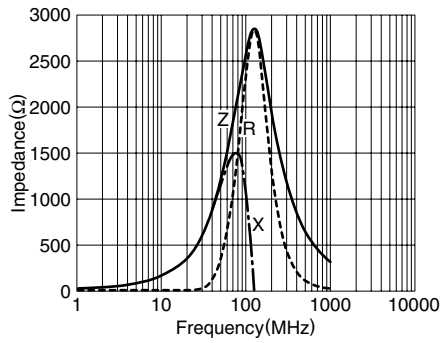

MMZ1608D050C

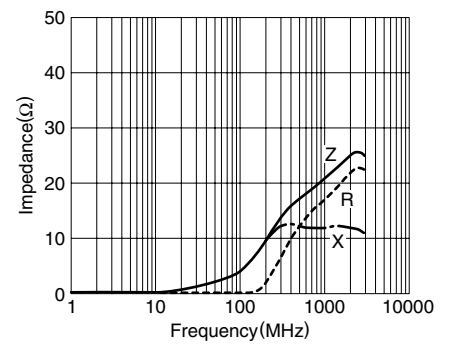

MMZ1608D100C

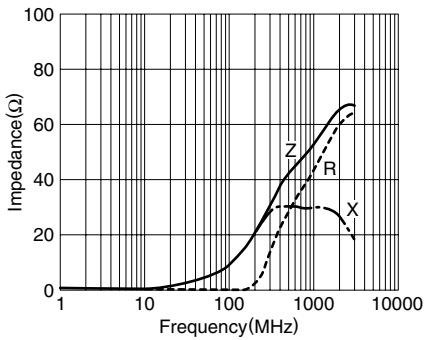

MMZ1608D220C

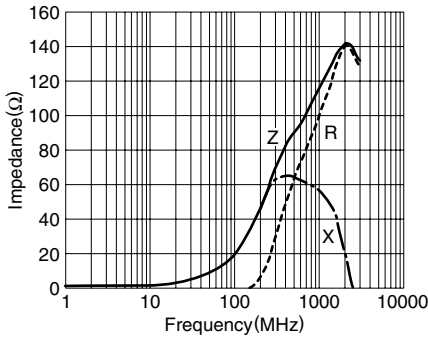

MMZ1608D500C

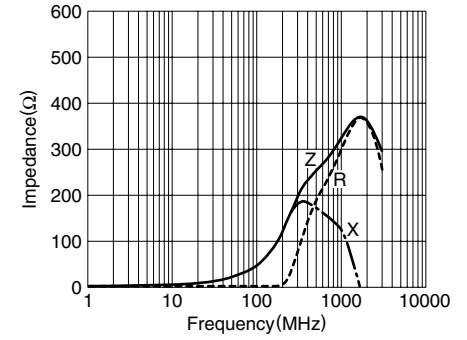

MMZ1608D800C

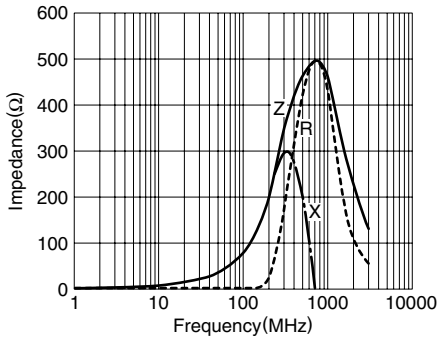

MMZ1608D800B

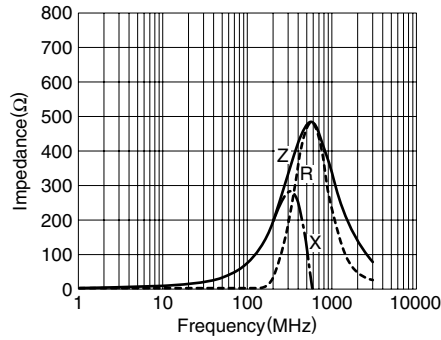

MMZ1608D121C

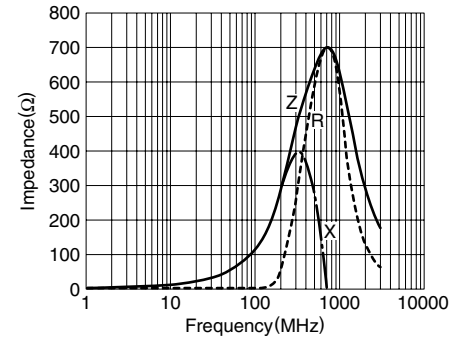

MMZ1608D121B

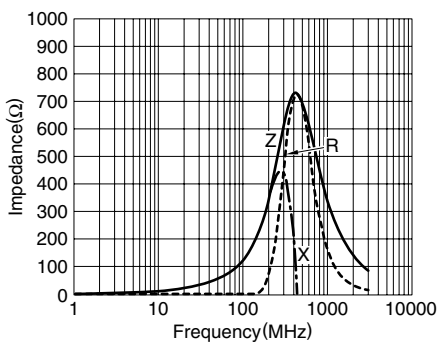

MMZ1608D241C

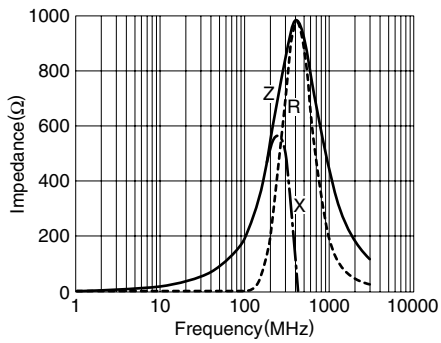

MMZ1608D301B

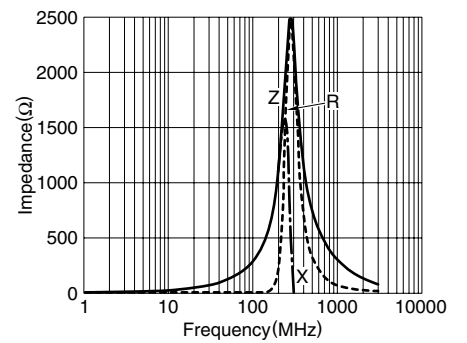

• All specifications are subject to change without notice.

PACKAGING STYLES REEL DIMENSIONS

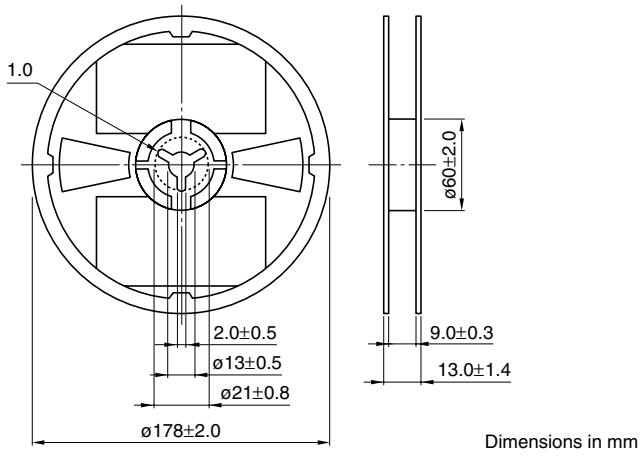

TAPE DIMENSIONS

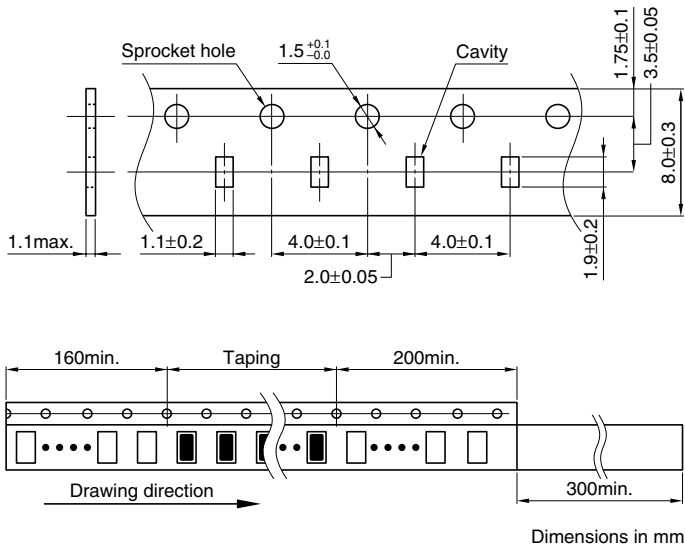

• All specifications are subject to change without notice.