

Technical Information

Liquipoint FTW23

Capacitance point level measurement

Point level switch for liquids in the food and beverage industry

Application

The Liquipoint FTW23 is a point level switch for water-based liquids and, when used with IO-Link, is also suitable for alcohol- and oil-based liquids or powdered products. It is used preferably in storage tanks, mixing vessels and pipes.

Developed and built for the food and beverage industry, the Liquipoint FTW23 meets international hygiene requirements.

The Liquipoint FTW23 can be used permanently in process temperatures up to 100 °C (212 °F) and in cleaning and sterilization processes up to 135 °C (275 °F) for 60 minutes.

Your benefits

- Individual adjustment to each medium not necessary
- Easy installation thanks to compact design - even in tight conditions or where access is restricted
- Robust stainless steel housing, optionally available with M12x1 connector with IP69 protection
- Onsite function check via LED indication
- Function testing of switch outputs with test magnet
- Can be cleaned and sterilized in place (CIP/SIP)
- 3-A and EHEDG certificates
- Meets the requirements of EU 1935/2004, 10/2011, 2023/2006 and FDA 21 CFR 177.2415
- Optionally available with IO-Link
 - Separate configuration of two switching thresholds, e.g. medium detection and medium differentiation
 - Increased protection in the event of a transient fault on the supply side
 - Customized adjustment possible for media from DC value ≥ 1.5







Table of contents

Document information	3	Operability	10
Document conventions	3	Operating concept for devices with IO-Link	10
Function and system design	3	IO-Link information	10
Measuring principle	3	IO-Link download	10
Measuring system	3	Light signals (LED)	11
Input	4	Device search	11
Measured variable	4	Sensor check	11
Measuring range	4	Function test	11
Output	4	Certificates and approvals	12
Switch output	4	CE approval	12
Power supply	5	EAC conformity	12
Supply voltage	5	RCM marking	12
Power consumption	5	Approval	12
Current consumption	5	Hygienic compatibility	12
Electrical connection	5	Hygiene approval	12
Cable specification	6	Manufacturer's declaration	12
Connecting cable length	6	Ordering information	13
Overvoltage protection	6	Accessories	14
Performance characteristics	6	Process adapter M24	14
Reference operating conditions	6	Weld-in adapter	14
Switching accuracy	6	Slotted nut DIN11851	14
Hysteresis	6	Additional accessories	14
Non-repeatability	6	Supplementary documentation	15
Switch-on delay	6	Operating Instructions	15
Switching delay	6	Supplementary documentation	15
Installation	6	Registered trademarks	15
Orientation	6		
Environment	7		
Ambient temperature range	7		
Storage temperature	7		
Climate class	7		
Altitude	7		
Degree of protection	7		
Shock resistance	8		
Vibration resistance	8		
Cleaning	8		
Electromagnetic compatibility	8		
Reverse polarity protection	8		
Short-circuit protection	8		
Process	9		
Process temperature range	9		
Process pressure range	9		
Process fluid	9		
Mechanical construction	9		
Weight	10		
Materials	10		

Document information

Document conventions

Symbols for certain types of information

Symbol	Meaning
	Permitted Indicates procedures, processes or actions that are allowed.
	Preferred Indicates procedures, processes or actions that are preferred.
	Tip Indicates additional information.
	Reference to page Refers to the corresponding page number.

Symbols in graphics

Symbol	Meaning
1, 2, 3 ...	Item numbers
A, B, C, ...	Views

Function and system design

Measuring principle

The capacitance at the tip of the sensor, and therefore the dielectric value of the medium, is determined using an electrical field. As air and a water-based liquid, for example, have different dielectric constants, the Liquipoint FTW23 can differentiate between the two states, "covered" and "free".

Measuring system

The measuring system comprises a Liquipoint FTW23 point level switch, e. g. for connecting to PLCs or an IO-Link master as per DIN EN 61131-9.

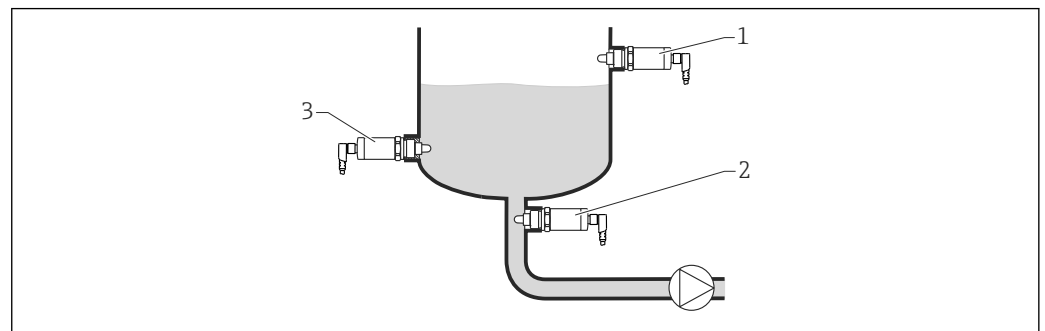

1 Application examples

- 1 Overfill protection or upper level detection (MAX)
- 2 Pump dry running protection (MIN)
- 3 Lower level detection (MIN)

System integration

For devices with IO-Link, an IO-DD is available in the Downloads area of the Endress+Hauser website →  10.

Input

Measured variable The change in medium capacitance is detected by the electrode in contact with the process.

Measuring range

- Water-based liquids, e.g. mineral water, milk and various milk products, soft drinks, beer and media with a dielectric constant (DC) > 20 (default)
- Device with IO-Link communication: adjustment up to DC > 1.5 via the IO-Link interface for water-, alcohol- and oil-based liquids or powdered products

The Liquipoint FTW33 is recommended for use in media with heavy build-up.

Output

Switch output	Designation	Option ¹⁾
	3-wire DC-PNP <ul style="list-style-type: none"> ▪ Positive voltage signal at the switch output of the electronics ▪ 2 DC-PNP outputs, switched using XOR operation ▪ 200 mA connectable load (short-circuit proof) 	4
	Devices with IO-Link <ul style="list-style-type: none"> ▪ 3- or 4-wire DC-PNP ▪ 2 DC-PNP outputs, freely configurable ▪ 1 switch output active: 200 mA connectable load (short-circuit proof) ▪ Both switch outputs active: connectable load of 105 mA each (short-circuit proof) 	7

1) Product Configurator, order code for "Power supply; output"

- Safety-related switching: MIN or MAX point level
The electrical switch opens if the point level is reached or if faults or a power outage occur.
 - Maximum point level detection (MAX): e. g. for overflow protection
The device keeps the electrical switch closed as long as the sensor is not yet covered by liquid. This is also the case for devices with IO-Link if the measured value is inside the process window.
 - Minimum point level detection (MIN): e. g. to protect pumps from dry running
The device keeps the electrical switch closed as long as the sensor is covered by liquid. This is also the case for devices with IO-Link if the measured value is outside the process window.
- Residual voltage: < 3 V
- Residual current: < 100 µA

Power supply

Supply voltage	10 to 30 V DC IO-Link communication is guaranteed only if the supply voltage is at least 18 V.
Power consumption	< 1.2 W (at max. load: 200 mA)
Current consumption	< 40 mA
Electrical connection	Voltage source: non-hazardous contact voltage or Class 2 circuit (North America). The device must be operated with a fine-wire fuse 500 mA (slow-blow). Depending on the evaluation of the switch outputs, the device works in the MAX (maximum point level detection) or MIN (minimum point level detection) modes.

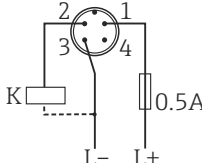
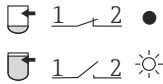
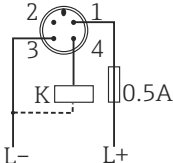
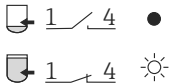
Electrical connection	Mode of operation	
	MAX	MIN
M12 connector 	 	 
Symbols	Description	
☀	Yellow LED (ye) lit	
•	Yellow LED (ye) not lit	
K	external load	

Function monitoring

With two-channel evaluation, functional monitoring of the sensor is also possible in addition to level monitoring provided that no other monitoring option has been configured via IO-Link.

When both outputs are connected, the MIN and MAX outputs assume opposite states when the device is operating fault-free (XOR). In the event of an alarm condition or a line break, both outputs are de-energized.

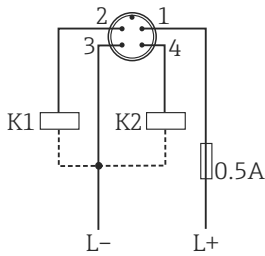
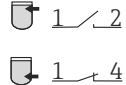
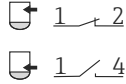
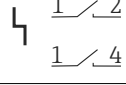
Connection for function monitoring using XOR operation		Yellow LED (ye)	Red LED (rd)
	Sensor covered		•
	Sensor uncovered		•
	Fault		☀
Symbols	Description		
☀	LED lit		
•	LED not lit		
⚡	Fault or warning		
K1 / K2	external load		

Devices with IO-Link

- i** IO-Link: communication on Q1; switch mode on Q2.
- SIO mode: if there is no communication, the device switches to the SIO mode = standard IO mode.

The factory-set functions for the MAX and MIN modes can be changed via IO-Link.

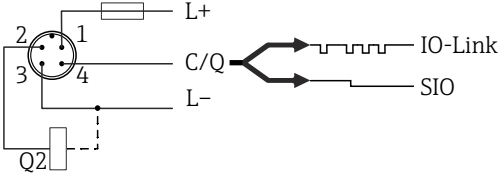
Electrical connection	IO-Link with one switch output ¹⁾
M12 connector 	 <p style="text-align: right;">A0034411</p>
	1 Supply voltage + 2 DC-PNP (Q2) 3 Supply voltage - 4 C/Q (IO-Link communication or SIO mode)

1) Product Configurator, order code for "Power supply; output", option 7

Cable specification IEC 60947-5-2

Connecting cable length

- Max. 25 Ω/core, total capacity < 100 nF
- IO-Link communication: < 10 nF

Overvoltage protection Overvoltage category II

Performance characteristics

Reference operating conditions	Horizontal orientation: <ul style="list-style-type: none"> ▪ Ambient temperature: 20 °C (68 °F) ±5 °C ▪ Medium temperature: 20 °C (68 °F) ±5 °C ▪ Process pressure: 1 bar (14.5 psi) ▪ Medium: water
Switching accuracy	±2 mm (0.08 in) in accordance with DIN 61298-2
Hysteresis	Typically ±1 mm (0.04 in)
Non-repeatability	±1 mm (0.04 in) in accordance with DIN 61298-2
Switch-on delay	< 2 s until correct switch status is set. Prior to that, the switch outputs are in a blocked state.
Switching delay	<ul style="list-style-type: none"> ▪ 0.5 s when sensor is covered ▪ 1.0 s when sensor is uncovered ▪ IO-Link communication: 0.3 to 600 s

Installation

Orientation **i** For installation in metallic or non-metallic vessels or pipes:
follow the EMC guidelines →  8.

- Can be installed in any position in a vessel, pipe or tank.
- For measuring points that are difficult to access, use a socket wrench.

The socket wrench can be ordered with the device or separately as an accessory (→ 14).

Installation in horizontal pipes:

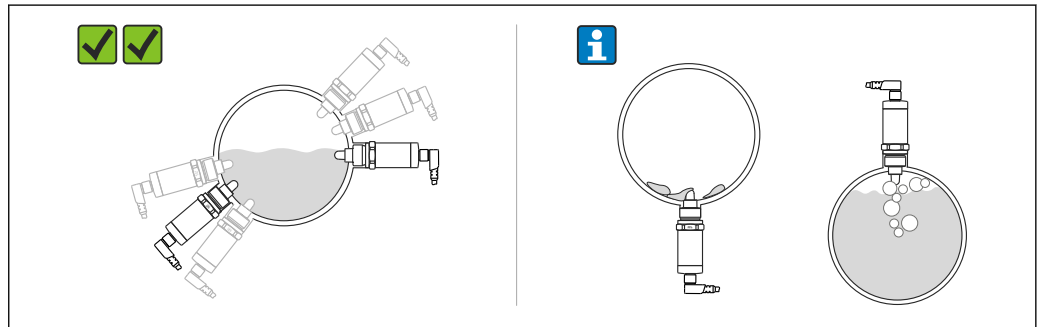

A0021052

i Vertical installation:

If the sensor is not completely covered by the medium or if there are air bubbles on the sensor, this may interfere with the measurement.

Environment

Ambient temperature range -20 to +70 °C (-4 to +158 °F), see following derating diagram:

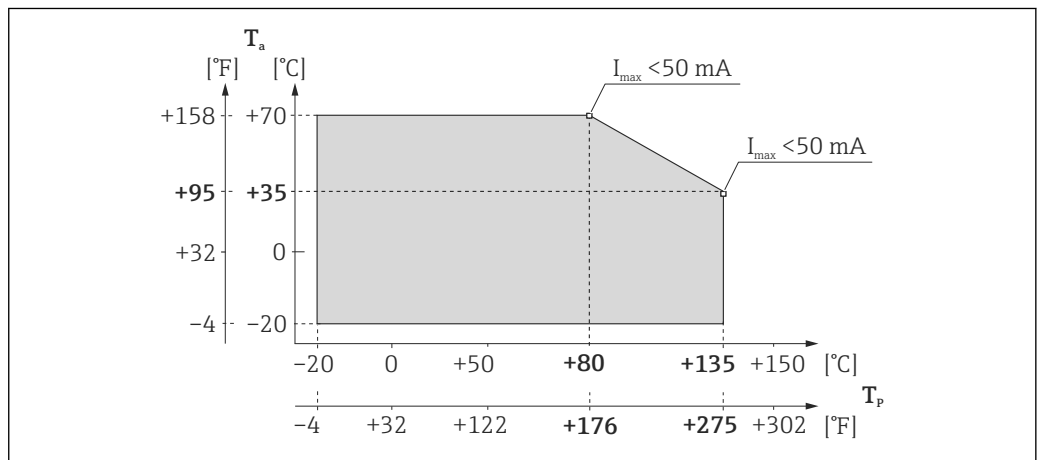

A0026131

T_a Ambient temperature

T_p Process temperature

Storage temperature -40 to +85 °C (-40 to +185 °F)

Climate class DIN EN 60068-2-38/IEC 68-2-38: test Z/AD

Altitude Up to 2 000 m (6 600 ft) above sea level

Degree of protection

- IP65/67 NEMA Type 4X Enclosure (M12 connector for plastic housing cover)
- IP66/68/69¹⁾ NEMA Type 4X/6P Enclosure (M12 connector for metal housing cover)

1) The IP69K protection class is defined in accordance with DIN 40050 Part 9. This standard was withdrawn on November 1, 2012 and replaced by DIN EN 60529. The name of the IP protection class changed to IP69 as part of this.

Shock resistance	In accordance with EA inspection, prEN 60068-2-27:2007: $a = 300 \text{ m/s}^2 = 30 \text{ g}$, 3 planes x 2 directions x 3 shocks x 18 ms
Vibration resistance	In accordance with test Fh, EN 60068-2-64:2008: $a(\text{RMS}) = 50 \text{ m/s}^2$, $f = 5$ to 2000 Hz, $t = 3$ planes x 2 h
Cleaning	Resistant to typical cleaning agents from the outside. Passed Ecolab test.
Electromagnetic compatibility	<p>The electromagnetic compatibility requirements outlined in the IEC/EN 61326 series for "industrial environments" and NAMUR Recommendation EMC (NE21) are met when the device is installed in metal vessels or pipes. Emission requirements for class B equipment are met. For details refer to the declaration of conformity.</p> <p>Only the requirements of IEC/EN 61131-9 are met if IO-Link communication is used.</p> <p>If the device is installed in plastic structures, its function may be influenced by strong electromagnetic fields. Emission requirements for class A equipment are met (only for use in "industrial environments").</p>
Reverse polarity protection	Integrated; no damage in the event of reverse polarity or short-circuit
Short-circuit protection	<ul style="list-style-type: none">▪ Overload protection/short-circuit protection at $I > 200 \text{ mA}$▪ Device with IO-Link: 105 mA per output if both switch outputs are active <p>Intelligent monitoring: Testing for overload at intervals of approx. 1.5 s; normal operation resumes once the overload/short-circuit has been rectified.</p>

Process

Process temperature range -20 to +100 °C (-4 to +212 °F)
 For 1 hour: +135 °C (+275 °F)

Process pressure range -1 to +16 bar (-14.5 to +232 psi)

Process fluid

- Water-based media with a dielectric constant (DC) > 20 (default)
- Device with IO-Link communication: adjustment up to DC > 1.5 via the IO-Link interface for water-, alcohol- and oil-based liquids or powdered products

Mechanical construction

Engineering unit mm (in)

<p>A0026265</p>	Electrical connection			
	M12 connector			
	<p>A0016840</p>			
	Dimensions, see "Accessories" section → 14			
	H1	Housing cover		
	1)	M	N	
		M12 plastic	M12 metal	
		<p>A0016846</p>	<p>A0016845</p>	
		21 (0.83)		
		Process connection, housing, sensor		
1)	W5J	WSJ	X2J	WVJ
	G ¾"	G 1"	M24x1.5	G ½" Hygiene adapter
	<p>A0021918</p>	<p>A0021920</p>	<p>A0021953</p>	<p>A0021916</p>
H2	56.7 (2.23)	53.2 (2.09)	65.7 (2.59)	47.2 (1.86)
H3	26.2 (1.03)	29.6 (1.17)	17.1 (0.67)	35.6 (1.40)
H4	16.1 (0.63)	19.6 (0.77)	12.8 (0.50)	15.1 (0.59)
H5	13 (0.51)			

1) For a description of the options, see the Product Configurator, order code for "Electrical connection", "process connection"

Weight max. 300 g (10.58 oz)

Materials Material specifications in accordance with AISI and DIN EN.

Materials in contact with process	Materials not in contact with process
Sensor: 316L (1.4404), PEEK The material PEEK meets the requirements of EU 1935/2004, 10/2011, 2023/2006 and FDA 21 CFR 177.2415	Housing covers: <ul style="list-style-type: none"> ▪ M12 metal: 316L (1.4404) ▪ M12 plastic: PPSU Design ring: PBT/PC
Process connection: 316L (1.4404/1.4435)	Housing: 316L (1.4404/1.4435) Nameplate: lasered onto housing

Wetted sensor surface: $R_a \leq 0.76 \mu\text{m}$ (30 μin)

 Endress+Hauser supplies DIN/EN process connections with threaded connection in stainless steel in accordance with AISI 316L (DIN/EN material number 1.4404 or 14435). In terms of their stability-temperature property, the materials 1.4404 and 1.4435 are grouped in EN 1092-1 table 18 under 13E0. The chemical composition of the two materials can be identical.

Operability

Operating concept for devices with IO-Link

Operator-oriented menu structure for user-specific tasks

Quick and safe commissioning

Guided menus for applications

Reliable operation

Operation in the following languages:

Via IO-Link: English

Efficient diagnostic behavior increases measurement availability

- Remedial measures
- Simulation options

IO-Link information

IO-Link is a point-to-point connection for communication between the measuring device and an IO-Link master. The measuring device features an IO-Link communication interface type 2 with a second IO function on pin 4. This requires an IO-Link-compatible assembly (IO-Link master) for operation. The IO-Link communication interface enables direct access to the process and diagnostic data. It also provides the option of configuring the measuring device while in operation.

Physical layer, the measuring devices supports the following features:

- IO-Link specification: version 1.1
- IO-Link Smart Sensor Profile 2nd Edition
- SIO mode: yes
- Speed: COM2; 38.4 kBaud
- Minimum cycle time: 6 msec.
- Process data width: 16 bit
- IO-Link data storage: yes
- Block configuration: no

IO-Link download

<http://www.endress.com/download>

- Select "Device Driver" from the list displayed
- In the Type search field, select "IO Device Description (IODD)"
- In the Product Code search field, select the product root
- Click "Search" button → Select result → Download

Optional: In the Text Search search field, enter the device name.

Light signals (LED)

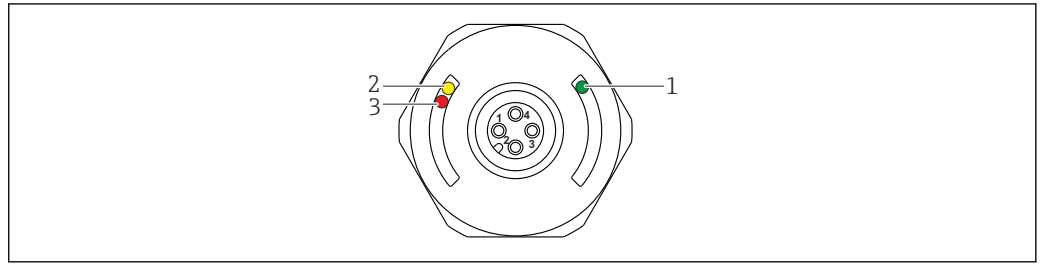

A0022024

2 Position of LEDs in housing cover

Position	LEDs	Functions	
1	Green LED (gn)	LED lit	Measuring device is operational
		<i>Device with IO-Link</i> <ul style="list-style-type: none"> ▪ LED lit ▪ LED flashes ▪ LED flashes more intensely <ul style="list-style-type: none"> ▪ Measuring device is operational in the SIO mode ▪ Active communication ▪ Device search (device identification) 	
2	Yellow LED (ye)	Indicates the state of the sensor	
3	LED red (rd)	LED flashes LED lit	Warning, maintenance required Fault, device failure

i With the metal housing cover (IP69) ²⁾ there is no external signaling via LEDs. A connection cable with an M12 connector and LED display can be ordered as an accessory → **14**.

Device search

IO-Link communication: The Device search parameter is used to uniquely identify the device during installation.

Sensor check

IO-Link communication: The Sensor check parameter checks if the measuring point is functioning correctly. The sensor must not be covered and must be free of residue.

Function test

Carry out a function test while the device is in operation.

- ▶ Hold the test magnet against the marking on the housing for at least 2 seconds.
 - ↳ This inverts the current switch status, and the yellow LED changes state. When the magnet is removed, the switch status valid at that time is adopted.

If the test magnet is held against the marking for longer than 30 seconds, the red LED will flash: The device returns automatically to the current switch status.

i The test magnet is not included in the scope of delivery. It can be ordered as an optional accessory → **14**.

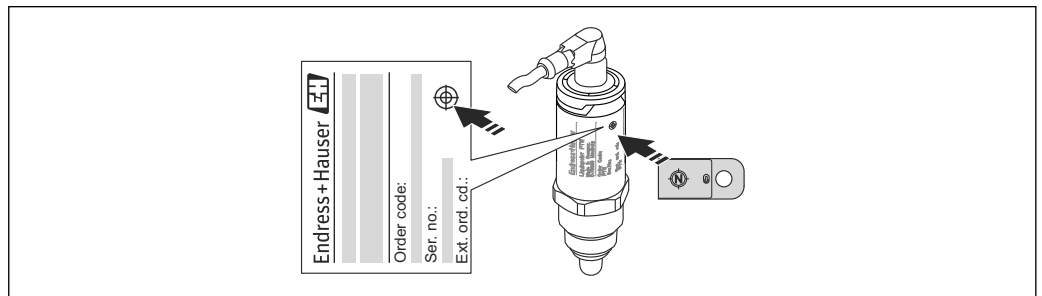

A0024417

3 Position for test magnet on housing

2) The IP69K protection class is defined in accordance with DIN 40050 Part 9. This standard was withdrawn on November 1, 2012 and replaced by DIN EN 60529. As a result, the name of the IP protection class has changed to IP69.

Certificates and approvals

CE approval

The measuring system complies with the statutory requirements of the applicable EC Directives. These are listed in the corresponding EC Declaration of Conformity together with the standards applied. Endress+Hauser confirms successful testing of the device by affixing to it the CE mark.

EAC conformity

The measuring system meets the legal requirements of the applicable EAC guidelines. These are listed in the corresponding EAC Declaration of Conformity along with the standards applied.

The manufacturer confirms successful testing of the device by affixing to it the EAC mark.

RCM marking

The supplied product or measuring system meets the ACMA (Australian Communications and Media Authority) requirements for network integrity, interoperability, performance characteristics as well as health and safety regulations. Here, especially the regulatory arrangements for electromagnetic compatibility are met. The products bear the RCM marking on the nameplate.



A0029561

Approval

CSA C/US General Purpose

Hygienic compatibility

The device has been developed for use in hygienic processes. The wetted materials meet the requirements of EU 1935/2004, 10/2011, 2023/2006 and FDA 21 CFR 177.2415 as well as the 3-A Sanitary Standard No. 74-xx. Endress+Hauser confirms this by affixing the 3-A symbol to the device.

The following certificate copies can be ordered with the device (optional):

3-A



EHEDG



- If cleaning in place (CIP) is required, weld-in adapters that comply with 3-A requirements are offered. If installed horizontally, ensure that the leakage hole is pointing down. This allows leaks to be detected as quickly as possible.
- To avoid the risk of contamination, install the device in accordance with the design principles of EHEDG, Document 37 "Hygienic Design and Application for Sensors" and Document 16 "Hygienic Pipe Connections".
- Suitable connections and seals must be used in order to guarantee a hygienic design in accordance with the specifications of 3-A and EHEDG.
- Information on 3-A and EHEDG-approved weld-in adapters can be found in the "Weld-in adapter, process adapter and flanges" documentation, TI00426F/00/EN.
- The gap-free connections can be cleaned of all residue using sterilization in place (SIP) and cleaning in place (CIP), which are typical cleaning methods within the industry. Attention must be paid to the pressure and temperature specifications of the sensor and process connections for CIP and SIP processes.

Hygiene approval

Process connections	Option	EHEDG	3-A
Thread ISO228 G 1, 316L, weld-in adapter installation accessory	WSJ	✓	✓
Thread ISO228 G ¾", 316L, weld-in adapter installation accessory	W5J	✓	✓
Thread M24, 316L, installation, adapter accessory	X2J	✓	✓

Manufacturer's declaration

The following documents can be ordered with the device (optional):

- FDA conformity
- Regulation (EC) No. 1935/2004 on materials and articles intended to come into contact with food

Ordering information

Detailed ordering information is available from the following sources:

- In the Product Configurator on the Endress+Hauser website: www.endress.com -> Click "Corporate" -> Select your country -> Click "Products" -> Select the product using the filters and search field -> Open product page -> The "Configure" button to the right of the product image opens the Product Configurator.
- From your Endress+Hauser Sales Center: www.addresses.endress.com



Product Configurator - the tool for individual product configuration

- Up-to-the-minute configuration data
- Depending on the device: Direct input of measuring point-specific information such as measuring range or operating language
- Automatic verification of exclusion criteria
- Automatic creation of the order code and its breakdown in PDF or Excel output format
- Ability to order directly in the Endress+Hauser Online Shop

Accessories

- Accessories can be ordered with the device (optional) or separately.
- The adapters are also available with inspection certificate 3.1 EN10204. For more information on process adapters and weld-in adapters, please refer to the supplementary documentation →  15.

Process adapter M24

Process adapter M24 for:	Pressure rating PN	Maximum pressure in combination with FTW23
Varivent N	40	16 bar (232 psi), see process pressure range →  9
Varivent F	40	
DIN11851 DN50 with slotted nut	25	
SMS 1 ½"	25	
Clamp 1 ½", 2"	40	
Material: 316L (1.4435) Seal for process adapter with M24 thread: EPDM		

Weld-in adapter

For thread:	Description
G ¾"	ø50 vessel installation, ø29 pipe installation
G 1"	ø53 pipe installation, ø60 vessel installation
M24	ø65 vessel installation
Material: 316L (1.4435) Seal for weld-in adapter G ¾", G 1": VMQ (silicone)	

Slotted nut DIN11851

For dairy pipe process connection DN50: F50

Material: 304 (1.4307)

Additional accessories

Designation	Order number
Test magnet	71267011
Special socket wrench for mounting, hex, 32AF	52010156

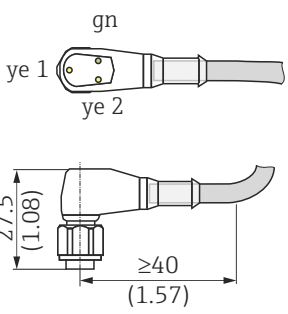
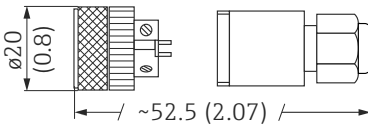
Designation	Order number
Cable, plug-in jack Engineering unit mm (in)  Example: M12 with LED	M12 IP69 with LED <ul style="list-style-type: none"> ▪ elbowed 90°, terminated at one end ▪ 5 m (16 ft) PVC cable (orange) ▪ Body: PVC (transparent) ▪ Slotted nut 316L 52018763
	M12 IP69 without LED <ul style="list-style-type: none"> ▪ elbowed 90°, terminated at one end ▪ 5 m (16 ft) PVC cable (orange) ▪ Body: PVC (orange) ▪ Slotted nut 316L (1.4435) 52024216
	M12 IP67 without LED <ul style="list-style-type: none"> ▪ elbowed 90° ▪ 5 m (16 ft) PVC cable (gray) ▪ Slotted nut Cu Sn/Ni ▪ Body: PUR (blue) 52010285
	M12 IP67 without LED <ul style="list-style-type: none"> ▪ straight, self-terminated connection to M12 connector ▪ Slotted nut Cu Sn/Ni ▪ Body: PBT 52006263
Wire colors for M12 connector: 1 = BN (brown), 2 = WT (white), 3 = BU (blue), 4 = BK (black)	

Supplementary documentation



The following document types are also available in the Download Area of the Endress+Hauser web site: www.endress.com → Download

Operating Instructions

- BA01373F/00/A2 → Liquipoint FTW23
- BA01792F/00/EN → Liquipoint FTW23 with IO-Link

Supplementary documentation

- TI00426F/00/DE → Weld-in adapters, process adapters and flanges (overview)
- SD01622Z/00/YY → Weld-in adapter (assembly manual)

Registered trademarks

 **IO-Link**

is a registered trademark of the IO-Link company group.



71619268

www.addresses.endress.com
