

# POWER TYPE



**BGR** ■ Rectangular Type Wirewound Resistors With Glass Core

**BWR** ■ Rectangular Type Wirewound Resistors With Ceramic Core

**BSR** ■ Rectangular Type Metal Oxide Film Resistors

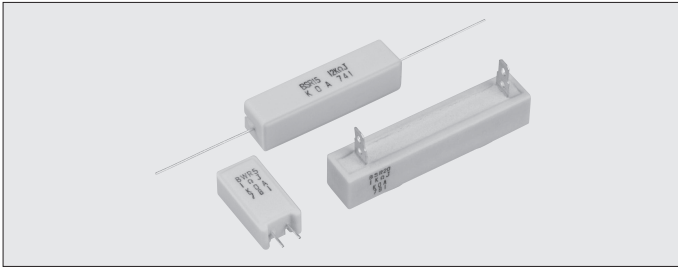

## Derating Curve

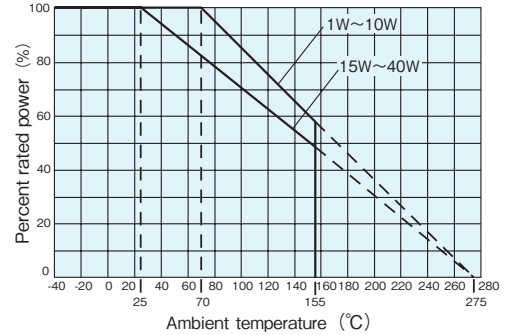

For resistors operated at an ambient temperature or higher, the power shall be derated in accordance with the above derating curve.

## Ratings

Type	Power Rating	Resistance Range (Ω) E24				Style & Weight (g/1pcs)														
		F : ±1%	G : ±2%	J : ±5%	K : ±10%	S	N	E	P	X	Y	YS	Z	H	Q	HA	HB	QA	QB	
BWR1	1W	1~56	0.22~75	0.1~75	—	1.3	—	—	—	—	—	—	—	—	—	—	—	—	—	
BWR2	2W	1~160	0.22~200	0.1~200	—	2.1	3.9	—	—	—	—	—	—	—	—	—	—	—	—	
BWR3	3W	1~300	0.22~390	0.1~390	—	3.9	5.9	—	—	—	—	—	—	—	—	—	—	—	—	
BWR5	5W	1~300	0.22~390	0.1~390	—	5.1	7.2	5.7	5.6	—	—	—	—	—	—	—	—	—	—	
BWR7	7W	1~360	0.22~390	0.1~390	—	7.5	10.8	—	—	—	—	—	—	—	—	—	—	—	—	
BWR10	10W	1~390	0.22~390	0.1~390	—	10.2	15.0	—	—	—	—	—	—	—	—	—	—	—	—	
BWR15	15W	1~390	0.22~390	0.1~390	—	18.8	—	—	—	—	—	—	—	—	—	—	—	—	—	
BWR20	20W	1~390	0.22~390	0.1~390	—	23.3	—	—	—	—	—	—	—	—	—	—	—	—	—	
BGR5	5W	—	—	10~390	0.39~9.1	—	—	—	—	6.1	7.6	6.6	7.6	—	6.2	—	—	—	—	
BGR7	7W	—	—	10~390	0.39~9.1	—	—	—	—	8.2	9.1	7.8	9.1	—	7.8	—	—	—	—	
BGR10	10W	—	—	10~390	0.39~9.1	—	—	—	—	11.0	12.4	10.4	11.4	9.9	10.7	13.6	—	14.5	—	
BGR15	15W	—	—	10~390	0.51~9.1	—	—	—	—	18.8	—	—	—	20.5	18.4	18.6	24.4	27.5	24.6	27.7
BGR20	20W	—	—	10~390	0.51~9.1	—	—	—	—	22.3	—	—	—	24.0	21.9	22.1	27.9	31.0	28.1	31.3
BGR30	30W	—	—	10~390	2.2~9.1	—	—	—	—	—	—	—	—	—	59.3	59.6	73.9	73.5	74.2	73.8
BGR40	40W	—	—	10~390	2.2~9.1	—	—	—	—	—	—	—	—	—	70.4	70.6	85.0	84.6	85.2	84.8
BSR2	2W	—	—	430~13k	—	2.1	3.8	—	—	—	—	—	—	—	—	—	—	—	—	—
BSR3	3W	—	—	430~27k	—	3.9	5.9	—	—	—	—	—	—	—	—	—	—	—	—	—
BSR5	5W	—	—	430~51k	—	5.1	7.2	5.7	—	6.1	7.6	6.6	7.6	—	6.2	—	—	—	—	—
BSR7	7W	—	—	430~56k	—	7.4	10.8	—	—	8.2	9.1	7.8	9.1	—	7.8	—	—	—	—	—
BSR10	10W	—	—	430~75k	—	10.2	15.0	—	—	11.0	12.4	10.4	11.4	10.9	10.7	13.7	—	14.5	—	—
BSR15	15W	—	—	430~56k	—	18.8	—	—	—	18.5	—	—	—	20.5	18.4	18.6	24.4	27.5	24.6	27.7
BSR20	20W	—	—	430~56k	—	23.3	—	—	—	22.0	—	—	—	24.0	21.9	22.1	27.9	31.0	28.1	31.3

Type	Power Rating	Rated Ambient Temperature	Max. Working Voltage (V)		Max. Overload Voltage (V)		T.C.R. (×10 <sup>-6</sup> /K)			Operating Temp. Range
			BSR	BGR·BWR	BSR	BGR·BWR	BWR	BSR	BGR	
BWR1	1W	+70°C	—	E=√P·R	—	E=√P·R·10	±100	±300	±250	-40°C~+155°C
BWR2	2W		250							
BWR3	3W		300							
BWR5	5W		350							
BWR7	7W		500							
BWR10	10W		700							
BWR15	15W		700							
BWR20	20W	750								
BGR30	30W	+25°C	—	—	—	—	—	—	—	
BGR40	40W		—	—	—	—	—	—	—	

Rated voltage = √Power Rating × Resistance value or Max. working voltage, whichever is lower.  
Please consult with us in advance about custom-made products.

## Type Designation

Example

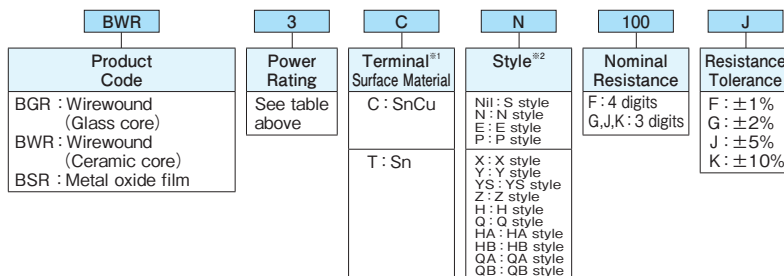

※1 Lead-Free plated terminal symbols.  
C (SnCu) : N, E, S and P styles  
T (Sn) : X, Y, YS, Z, H and Q styles  
※2 No indication on style means S style.  
Contact us when you have control request for environmental hazardous material other than the substance specified by EU-RoHS.

High Power Type Resistors

## Features

- High-power resistor.
- Using flame-retardant/insulated ceramic case.
- Excellent in anti-pulse and inrush current.
- Products meet EU-RoHS requirements.

## Dimensions

### ① S Style

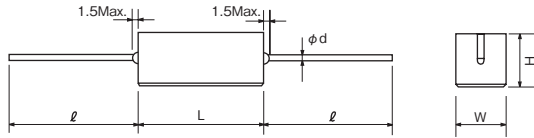

Type	Dimensions (mm)				
	L	W	H	$\ell \pm 3$	$d \pm 0.1$
BWR1C	13±1.0	5.5±1.0	5.5±1.0	30	0.6
BWR2C · BSR2C	18±1.5	6.3±1.0	6.3±1.0		
BWR3C · BSR3C	22±1.5	8.0±1.0	8.0±1.0	35	0.8
BWR5C · BSR5C		9.5±1.0	9.5±1.0		
BWR7C · BSR7C	48±1.5				
BWR10C · BSR10C		63.5±1.5	12.5±1.5		
BWR15C · BSR15C					
BWR20C · BSR20C					

### ② N Style

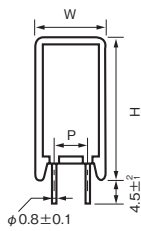

### ③ E Style

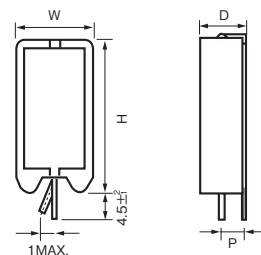

Type	Dimensions (mm)			
	W±1	D±1	H±1.5	P±0.2
BWR2CN · BSR2CN	11	7	20.5	5
BWR3CN · BSR3CN	12	8	25	
BWR5CN · BSR5CN	13	9	25.5	
BWR7CN · BSR7CN			38.5	
BWR10CN · BSR10CN	16	12	35	7.5
BWR5CE · BSR5CE	9.5	9.5	23.5	5

### ④ P Style

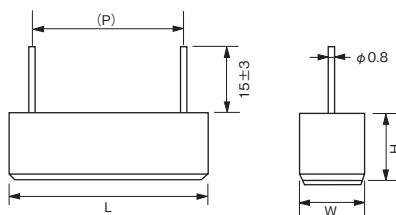

Type	Dimensions (mm)			
	L	W±1.5	H±1.5	(P)
BWR5CP	23±1.5	9.5	9.5	20

Parenthesized dimensions are for reference.  
Please refrain from using these parts as a board-insertion type.  
Only soldering doesn't have enough joint strength.  
Additional fixation is recommended.

### ⑤ X Style

(5W~10W)

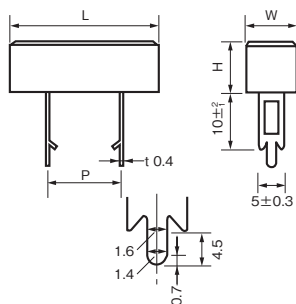

(15W, 20W)

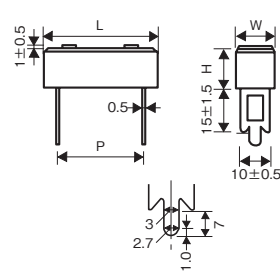

### ⑥ Y Style

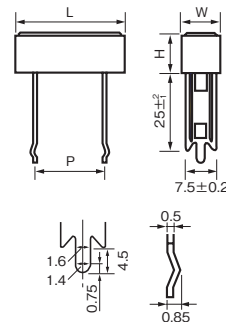

### ⑦ YS Style

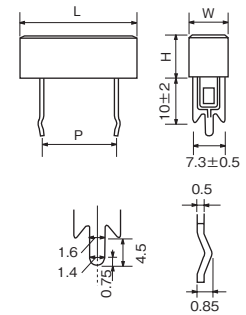

Type	Dimensions (mm)			
	L±1.5	W	H±1.0	P±1.5
BGR5TX · BSR5TX · BGR5TY · BSR5TY · BGR5TYS · BSR5TYS	27	9.5±1	9.5	15
BGR7TX · BSR7TX · BGR7TY · BSR7TY · BGR7TYS · BSR7TYS	35			22.5
BGR10TX · BSR10TX · BGR10TY · BSR10TY · BGR10TYS · BSR10TYS	48	12.5±1.5	12.5	35
BGR15TX · BSR15TX				32.5
BGR20TX · BSR20TX	63.5			47.5

# POWER TYPE

## ■ Dimensions

### ⑧ Z Style

(5W~10W)

(15W, 20W)

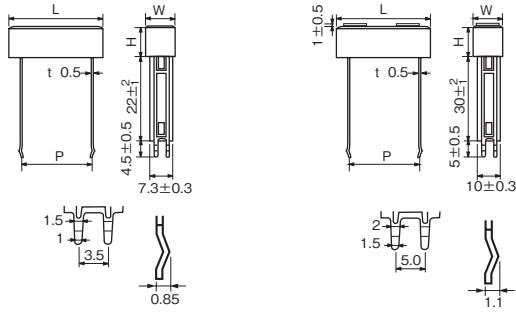

Type	Dimensions (mm)			
	L±1.5	W±1.0	H	P
BGR5TZ·BSR5TZ	27	9.5	9.5±1	15 <sup>+0.6</sup> <sub>-0.2</sub>
BGR7TZ·BSR7TZ	35			22.5 <sup>+0.6</sup> <sub>-0.2</sub>
BGR10TZ·BSR10TZ	48			35 <sup>+0.6</sup> <sub>-0.2</sub>
BGR15TZ·BSR15TZ	63.5	12.5	12.5±1.5	32.5 <sup>+0.4</sup> <sub>-0.0</sub>
BGR20TZ·BSR20TZ				47.5 <sup>+0.4</sup> <sub>-0.0</sub>

### ⑨ H Style

### ⑩ Q Style

(15W, 20W)

(5W, 7W, 10W, 30W, 40W)

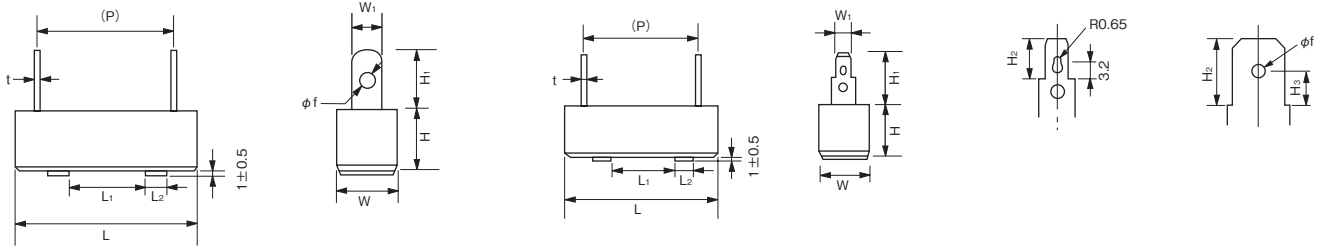

Type	Dimensions (mm)											
	L	L <sub>1</sub>	L <sub>2</sub>	W	W <sub>1</sub>	H	H <sub>1</sub> ±1.0	H <sub>2</sub>	(H <sub>3</sub> )	(P)	t	(φf)
BGR10TH·BSR10TH	48±1.5	25±1.0	4.5	9.5±1.0	5.0	9.5±1.0	7.0	—	—	35	0.4	2.0
BGR15TH·BSR15TH			7.0	12.5±1.2	6.0	12.5±1.5	8.5					
BGR20TH·BSR20TH			7.0	12.5±1.2	6.0	12.5±1.5	8.5					
BGR30TH	75±2.5	40±1.2	10.0	19.0±1.5	7.5	19.0±1.5	11.0	—	—	56	0.5	3.0
BGR40TH	90±2.5									71		
BGR5TQ·BSR5TQ	27±1.5	—	—	9.5±1.0	4.75	9.5±1.0	10.5	6.5	3.3	15.0	0.5	2.2
BGR7TQ·BSR7TQ	35±1.5	—	—							22.5		
BGR10TQ·BSR10TQ	48±1.5	25±1.0	4.5							12.5±1.2		
BGR15TQ·BSR15TQ	63.5±2		7.0	34.5								
BGR20TQ·BSR20TQ	90±2.5		7.0	49.5								
BGR30TQ	75±2.5	40±1.2	10.0	19.0±1.5	6.3	19.0±1.5	8.0	4.1	56	0.8	1.7	
BGR40TQ	90±2.5								71			

Parenthesized dimensions are for reference.

### ⑪ HA · QA Style

### ⑫ HB · QB Style

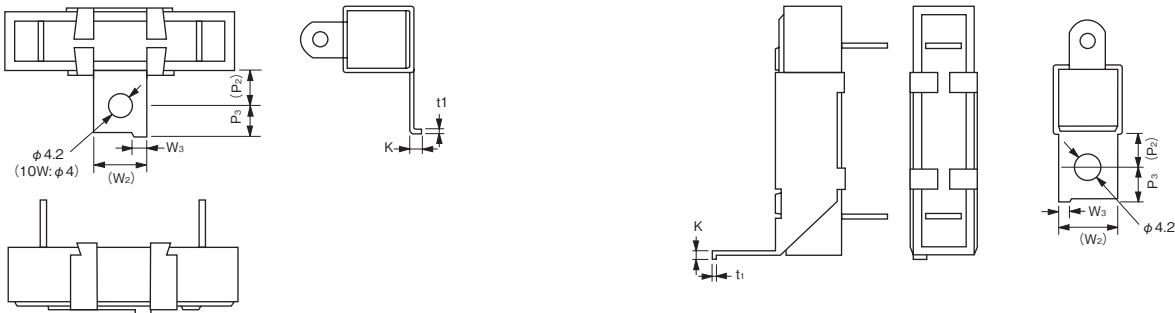

Type	Dimensions (mm)					
	(P <sub>2</sub> )	P <sub>3</sub> ±1	(W <sub>2</sub> )	W <sub>3</sub> ±0.3	K±0.3	t <sub>i</sub>
BGR10THA·BSR10THA·BGR10TQA·BSR10TQA	8.0	6	12	3.0	2.8	0.6
BGR15THA·BSR15THA·BGR15TQA·BSR15TQA						0.8
BGR15THB·BSR15THB·BGR15TQB·BSR15TQB						
BGR20THA·BSR20THA·BGR20TQA·BSR20TQA	10	8	18	3.0	3.0	0.8
BGR20THB·BSR20THB·BGR20TQB·BSR20TQB						
BGR30THA·BGR30TQA						
BGR30THB·BGR30TQB						
BGR40THA·BGR40TQA						
BGR40THB·BGR40TQB						

Parenthesized dimensions are for reference.

## Temperature Rise (Ref.)

① S Style

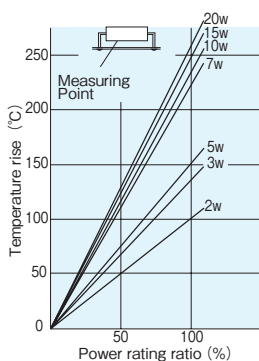

② N Style

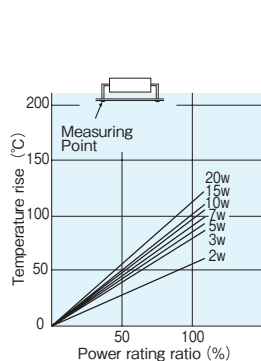

③ E Style

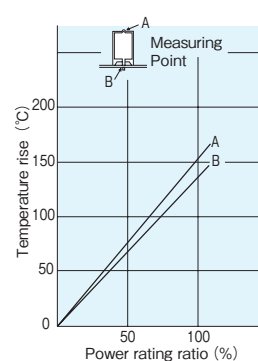

④ X Style

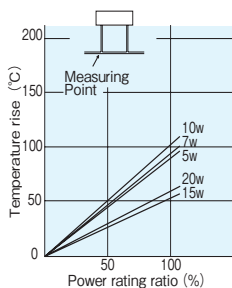

⑤ Y Style

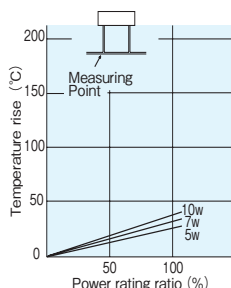

⑥ YS Style

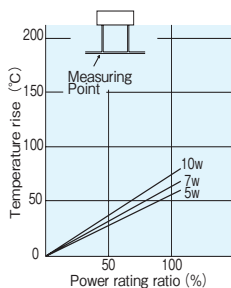

⑦ Z Style

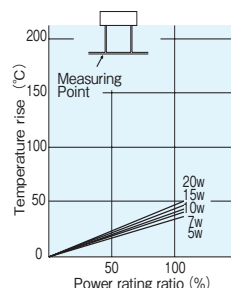

⑧ H, Q Style

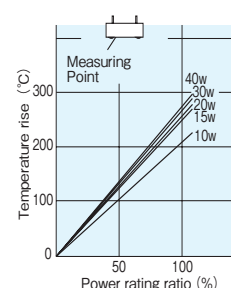

## Performance

Test Items	Performance Requirements $\Delta R \pm \%$		Test Methods
	Limit	Typical	
Resistance	Within specified tolerance	—	25°C
T.C.R.	Within specified T.C.R.	—	+25°C/+125°C
Resistance to soldering heat	1 : BWR, BSR 2 : BGR	0.8 : BWR 1.7 : BGR 0.9 : BSR	350°C ± 10°C, 3.5s 260°C ± 5°C, 10s
Moisture resistance	3 : BWR, BGR 5 : BSR	2.4 : BWR 2.55 : BGR 4.5 : BSR	Power rating × 1/10, 40°C, 90%~95%RH, 1000h 1.5h ON/0.5h OFF cycle
Endurance at 25°C or 70°C	3 : BWR 5 : BGR, BSR	2.4 : BWR 4.25 : BGR 4.5 : BSR	25°C or 70°C, rated voltage, 1000h, 1.5h ON/0.5h OFF cycle

## Precautions for Use

- The products attached by ionic impurities negatively affects their moisture resistance, corrosion resistance, etc. Please pay careful attention to products handling as well as storage, mounting conditions and environment.
- When the pulse including surge is impressed to the resistor, it may cause disconnection. Please confirm us about the conditions for use in advance.
- In case of using them for an AC circuit, abnormal phenomena like oscillation etc. occasionally happen as they have an inductance or a parasitic capacitance because of their wiring structures. Use them by taking the dispersion of constants of other components into the consideration.