



Surface Mount Fast Recovery Rectifiers

Reverse Voltage - 50 to 1000 V

Forward Current - 5A

FEATURES

- For surface mounted applications
- Low profile package
- Glass Passivated Chip Junction
- Easy to pick and place
- Fast reverse recovery time
- Lead free in comply with EU RoHS 2011/65/EU directives

MECHANICAL DATA

- Case: SMB
- Terminals: Solderable per MIL-STD-750, Method 2026
- Approx. Weight: 0.1g / 0.003oz

PINNING

| PIN | DESCRIPTION |
|-----|-------------|
| 1 | Cathode |
| 2 | Anode |

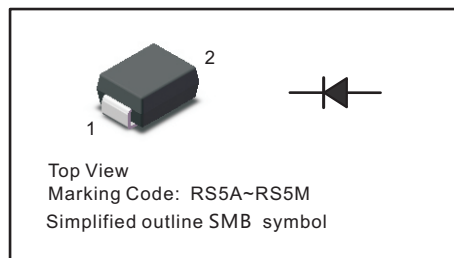

Absolute Maximum Ratings and Characteristics

Ratings at 25 °C ambient temperature unless otherwise specified. Single phase, half wave, 60 Hz, resistive or inductive load. For capacitive load, derate current by 20%.

| Parameter | Symbols | RS5AB | RS5BB | RS5DB | RS5GB | RS5JB | RS5KB | RS5MB | Units |
|--|------------------------------------|------------|-------|-------|-------|-------|-------|-------|--------------------|
| Maximum Repetitive Peak Reverse Voltage | V_{RRM} | 50 | 100 | 200 | 400 | 600 | 800 | 1000 | V |
| Maximum RMS voltage | V_{RMS} | 35 | 70 | 140 | 280 | 420 | 560 | 700 | V |
| Maximum DC Blocking Voltage | V_{DC} | 50 | 100 | 200 | 400 | 600 | 800 | 1000 | V |
| Maximum Average Forward Rectified Current | $I_{F(AV)}$ | 5 | | | | | | | A |
| Peak Forward Surge Current 8.3 ms Single Half Sine Wave Superimposed on Rated Load | I_{FSM} | 120 | | | | | | | A |
| Maximum Forward Voltage at 5 A | V_F | 1.3 | | | | | | | V |
| Maximum DC Reverse Current at Rated DC Blocking Voltage $T_a = 25\text{ }^\circ\text{C}$ $T_a = 125\text{ }^\circ\text{C}$ | I_R | 10 150 | | | | | | | μA |
| Typical Junction Capacitance at $V_R=4\text{V}$, $f=1\text{MHz}$ | C_j | 45 | | | | | | | pF |
| Maximum Reverse Recovery Time ⁽¹⁾ | t_{rr} | 150 | | | | 250 | 500 | | ns |
| Typical Thermal Resistance ⁽²⁾ | $R_{\theta JA}$ $R_{\theta JC}$ | 48 16 | | | | | | | $^\circ\text{C/W}$ |
| Operating and Storage Temperature Range | T_j, T_{stg} | -55 ~ +150 | | | | | | | $^\circ\text{C}$ |

(1) Measured with $I_F = 0.5\text{ A}$, $I_R = 1\text{ A}$, $I_{rr} = 0.25\text{ A}$.

(2) P.C.B. mounted with 2.0" X 2.0" (5 X 5 cm) copper pad areas.



Fig.1 Maximum Average Forward Current Rating

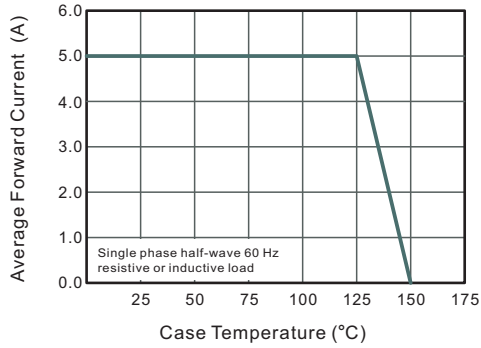

Fig.2 Typical Reverse Characteristics

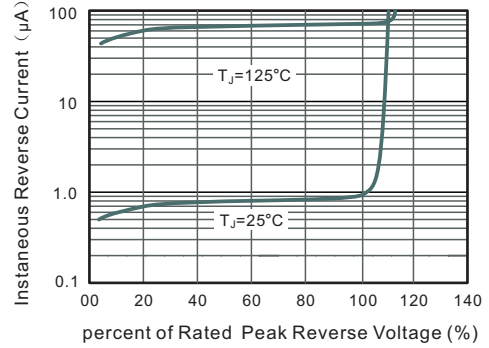

Fig.3 Typical Instantaneous Forward Characteristics

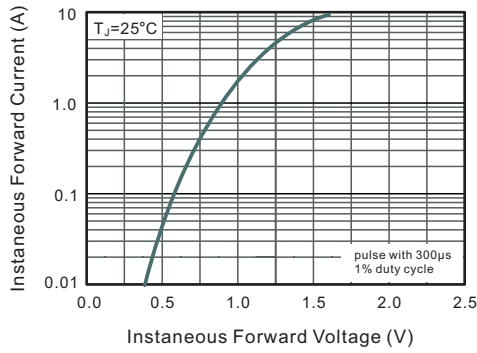

Fig.4 Typical Junction Capacitance

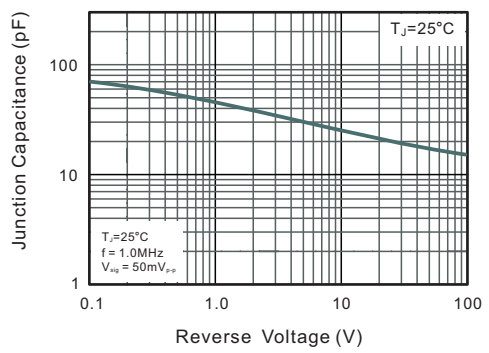
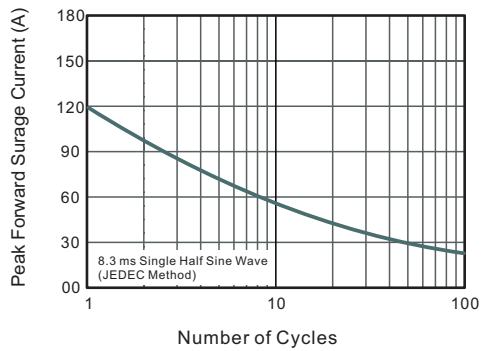

Fig.5 Maximum Non-Repetitive Peak Forward Surge Current





PACKAGE OUTLINE

Plastic surface mounted package; 2 leads

SMB

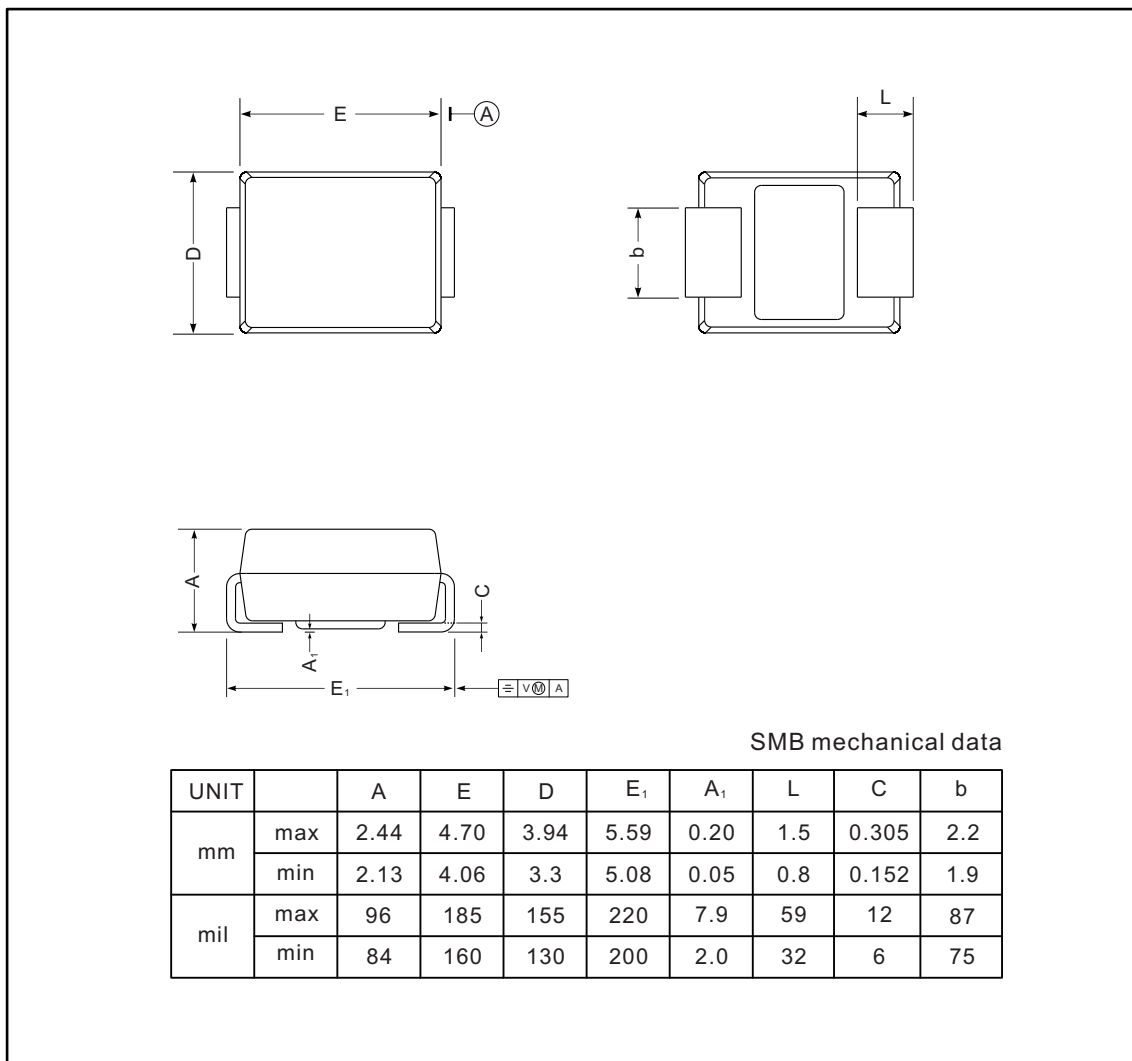

The recommended mounting pad size

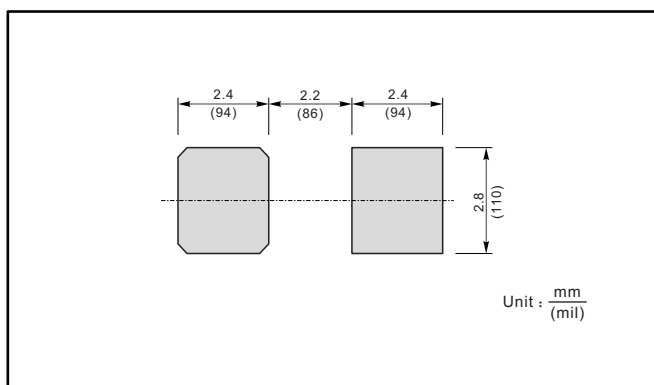

Marking

| Type number | Marking code |
|-------------|--------------|
| RS5AB | RS5A |
| RS5BB | RS5B |
| RS5DB | RS5D |
| RS5GB | RS5G |
| RS5JB | RS5J |
| RS5KB | RS5K |
| RS5MB | RS5M |