

SN·MP-PC SERIES

SN · MP-PC BATTERY HOLDER FOR THROUGH HOLE

SN 3-1PC

AA cell×1

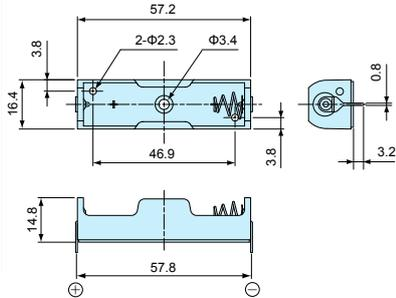

SN 3-2PC

AA cell×2

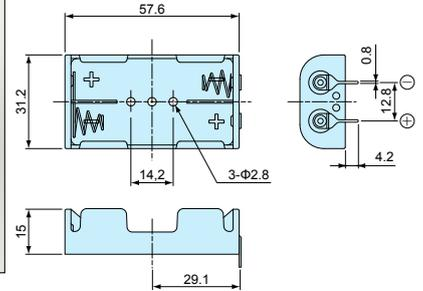

SN 3-3PC

AA cell×3

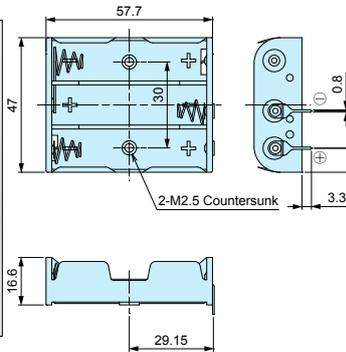

SN 3-4PC

AA cell×4

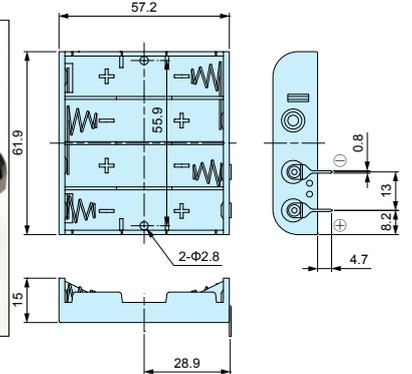

MP-4-1PC

AAA cell×1

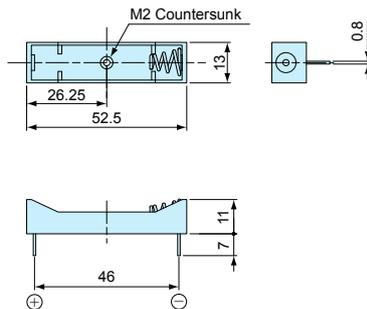

SN 4-2PC

AAA cell×2

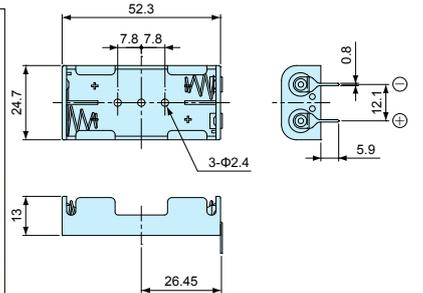

Components

Holder material	Spring / Finish	Terminal / Finish	P.C pin
PP / PE / ABS	Steel / Nickel plating	Brass / Nickel plating	Steel Ni plating / Steel Sn Plating

Part no.

Part no.	Battery	Holder material	P.C pin / Finish	Weight(g)
SN 3-1PC	AA (UM3) × 1	PP	Steel / nickel plating	3.6
SN 3-2PC	AA (UM3) × 2	PE	Steel / nickel plating	7.0
SN 3-3PC	AA (UM3) × 3	PP	Steel / nickel plating	9.4
SN 3-4PC	AA (UM3) × 4	PP	Steel / nickel plating	11.5
MP-4-1PC	AAA (UM4) × 1	ABS	Steel / Sn plating	2.5
SN 4-2PC	AAA (UM4) × 2	PP	Steel / nickel plating	4.5

SN-S SERIES

SN-S BATTERY HOLDER WITH SNAP TERMINAL

• Recommended to use with MP battery snap.

SN 1-2S

D cell×2

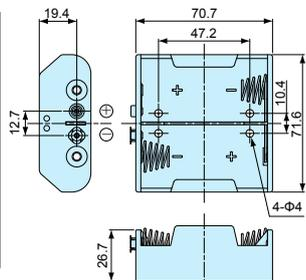

SN 1-4S

D cell×4

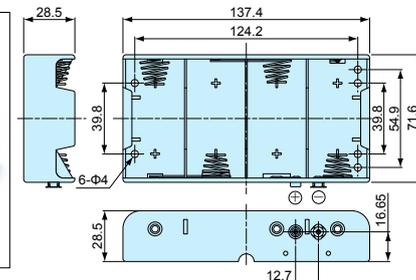

SN 2-2S

C cell×2

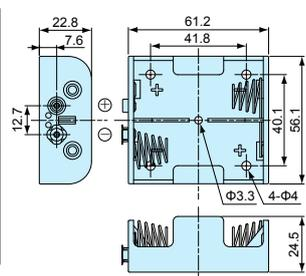

SN 2-4S

C cell×4

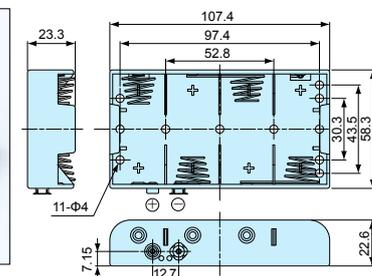

SN 3-2S

AA cell×2

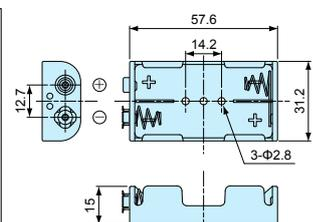

SN 3-3S

AA cell×3

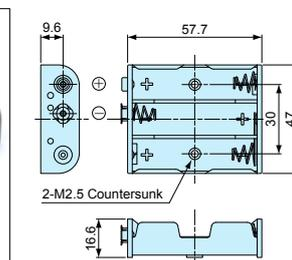

SN 3-4S

AA cell×4

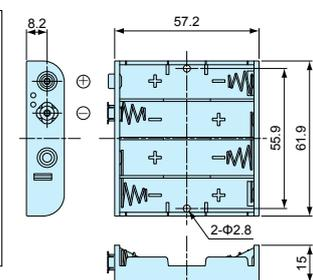

Components

Holder material	Spring / Finish	Terminal / Finish
PP / PE	Steel / Nickel plating	Brass / Nickel plating

Part no.

Part no.	Battery	Holder material	Weight(g)
SN 1-2 S	D (UM1) × 2	PP	22.7
SN 1-4 S	D (UM1) × 4	PP	43.6
SN 2-2 S	C (UM2) × 2	PP	16.5
SN 2-4 S	C (UM2) × 4	PP	26.0
SN 3-2 S	AA (UM3) × 2	PE	7.2
SN 3-3 S	AA (UM3) × 3	PP	9.6
SN 3-4 S	AA (UM3) × 4	PP	11.8

SN·MP·BH211 SERIES

SN · BH · MP BATTERY HOLDER WITH LEAD WIRE

SN 1-1

D cell×1

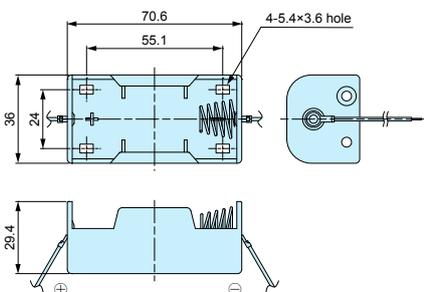

SN 1-2

D cell×2

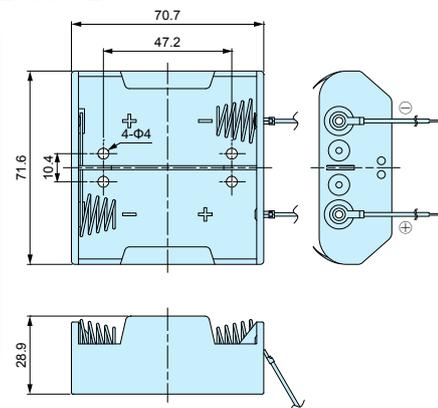
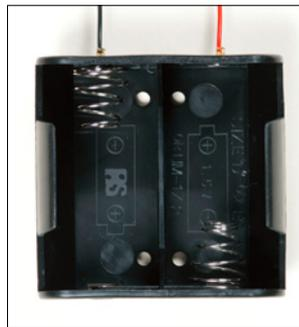

SN 1-4

D cell×4

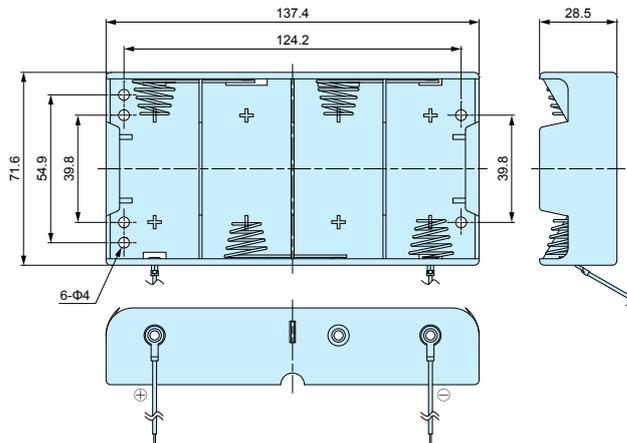
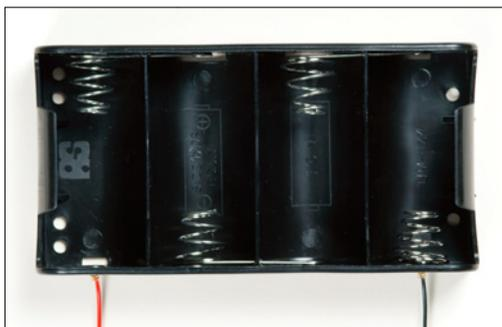

SN 1-6

D cell×6

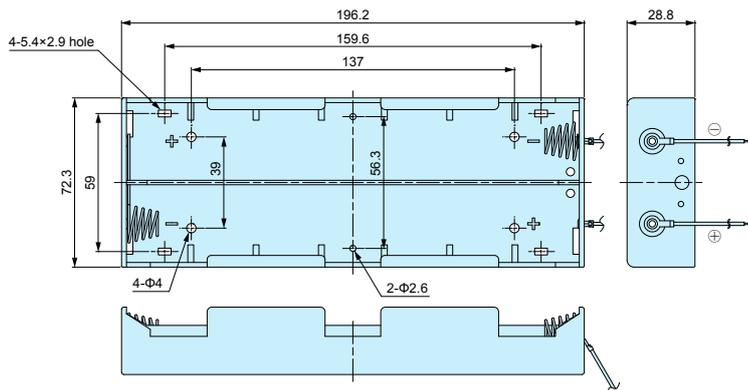

BH211-1

C cell×1

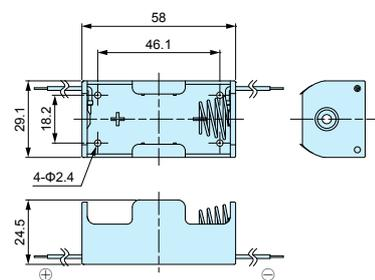

SN 2-2

C cell×2

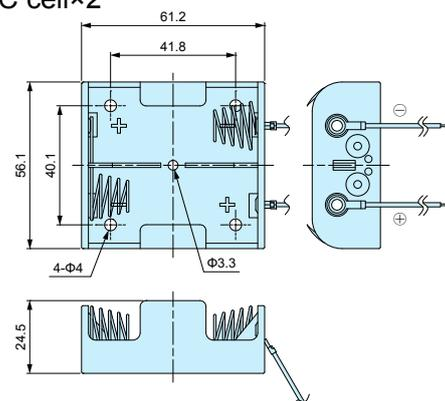
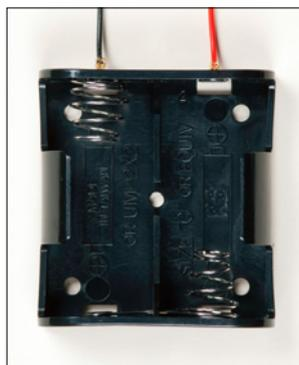

SN 2-4

C cell×4

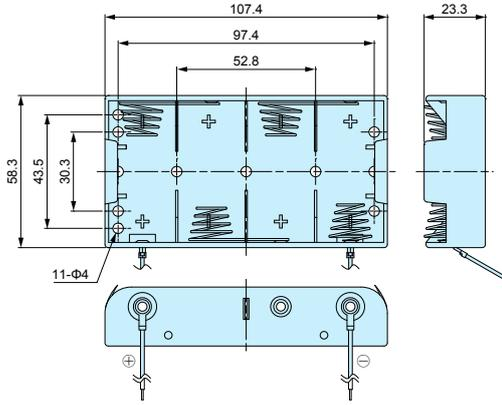
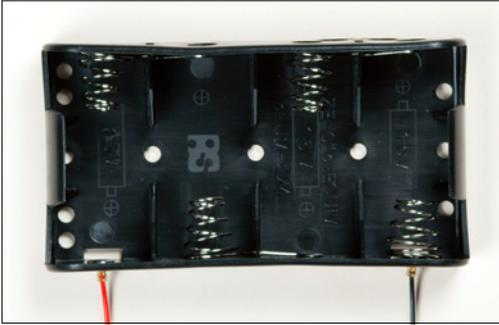

SN 3-1

AA cell×1

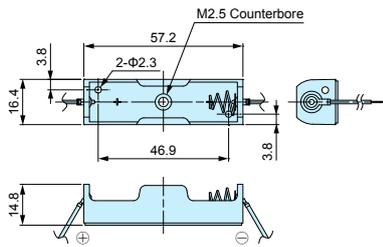

SN 3-2

AA cell×2

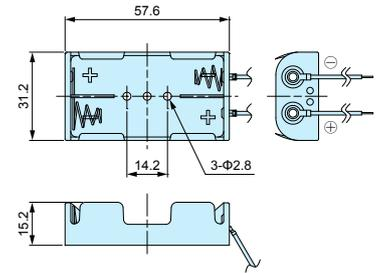
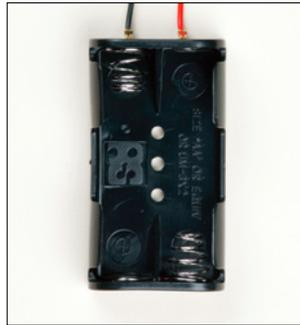

SN 3-2A

AA cell×2

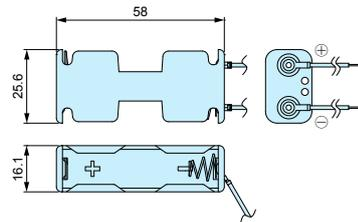
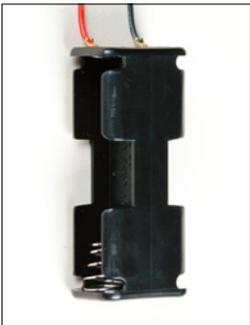

SN 3-3

AA cell×3

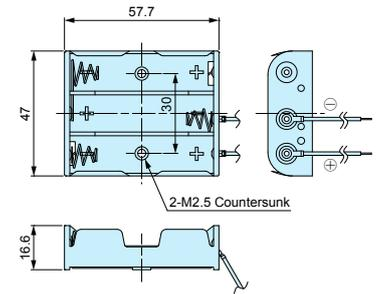
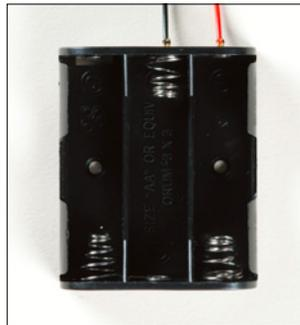

SN 3-4

AA cell×4

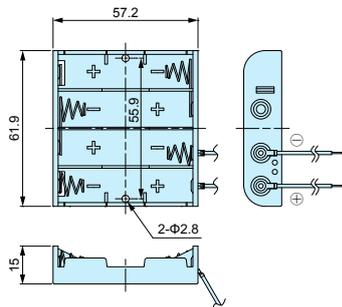

SN 3-4A

AA cell×4

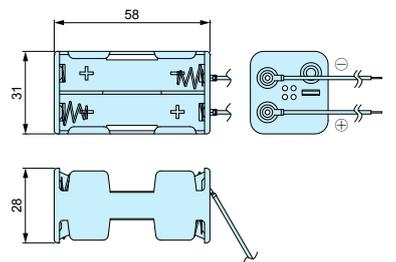

MP-3-6

AA cell×6

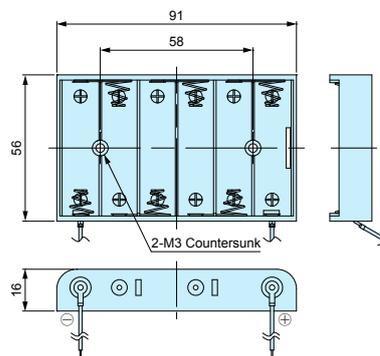
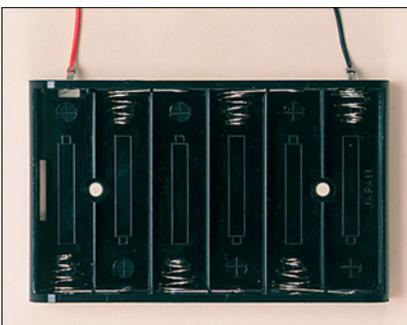

SN 3-6A

AA cell×6

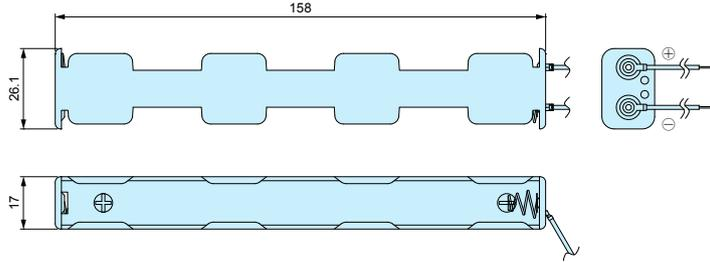

SN 3-6B

AA cell×6

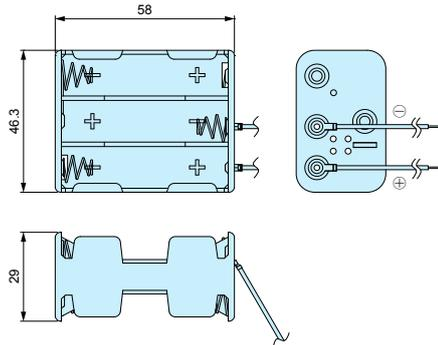

SN 3-8A

AA cell×8

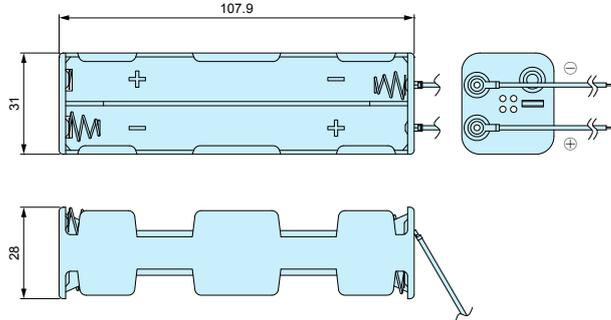
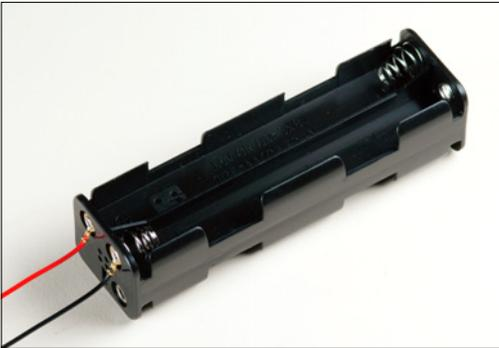

MP-4-1

AAA cell×1

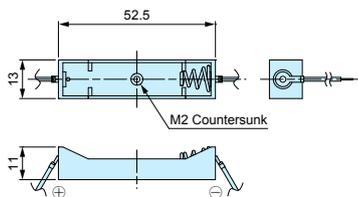

SN 4-2

AAA cell×2

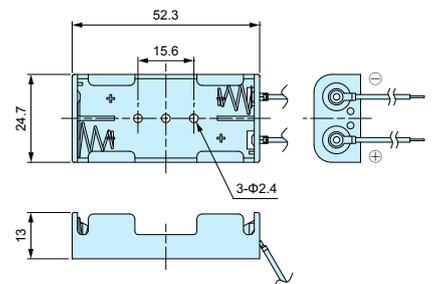
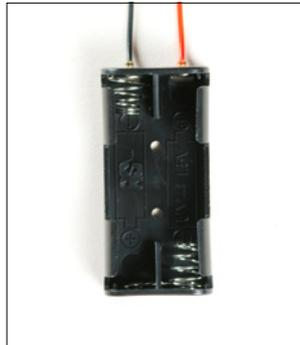

MP-4-3

AAA cell×3

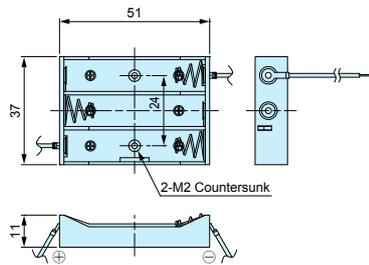

MP-4-4

AAA cell×4

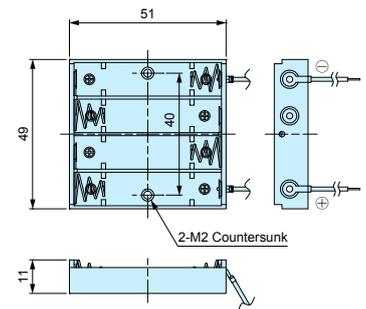

MP-5-1N

N cell×1

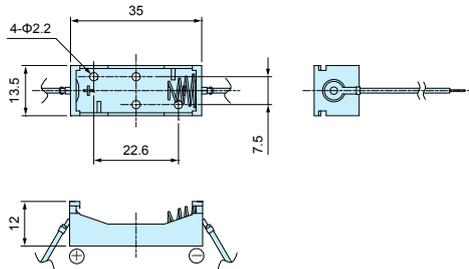

MP-5-2

N cell×2

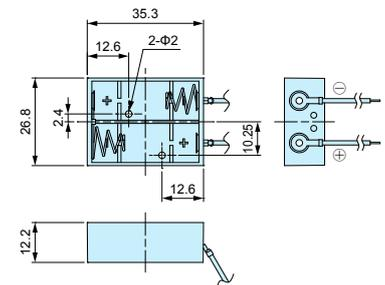
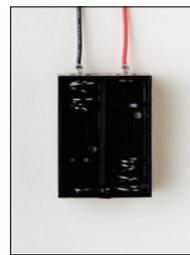

Components

Holder material	Spring / Finish	Terminal / Finish	Wire
PP / PE / ABS	Steel / Nickel plating	Brass / Nickel plating	AWG24 / AWG26 (UL1007)

Part no.

Part no.	Battery	Holder material	Wire	Weight(g)
SN 1-1	D (UM1) × 1	PP	AWG26 L=170	14.0
SN 1-2	D (UM1) × 2	PP	AWG26 L=170	22.8
SN 1-4	D (UM1) × 4	PP	AWG26 L=170	43.0
SN 1-6	D (UM1) × 6	PP	AWG26 L=170	52.7
BH211-1	C (UM2) × 1	PP	AWG24 L=150	9.3
SN 2-2	C (UM2) × 2	PP	AWG26 L=170	16.5
SN 2-4	C (UM2) × 4	PP	AWG26 L=170	26.0
SN 3-1	AA (UM3) × 1	PP	AWG26 L=160	4.4
SN 3-2	AA (UM3) × 2	PE	AWG26 L=160	7.8
SN 3-2A	AA (UM3) × 2	PP	AWG26 L=160	6.2
SN 3-3	AA (UM3) × 3	PP	AWG26 L=160	10.2
SN 3-4	AA (UM3) × 4	PP	AWG26 L=160	12.1
SN 3-4A	AA (UM3) × 4	PP	AWG26 L=160	9.8
MP-3-6	AA (UM3) × 6	ABS	AWG26 L=150	21.4
SN 3-6A	AA (UM3) × 6	PP	AWG26 L=160	12.9
SN 3-6B	AA (UM3) × 6	PP	AWG26 L=160	15.3
SN 3-8A	AA (UM3) × 8	PP	AWG26 L=160	14.8
MP-4-1	AAA (UM4) × 1	ABS	AWG26 L=150	3.3
SN 4-2	AAA (UM4) × 2	PP	AWG26 L=160	5.1
MP-4-3	AAA (UM4) × 3	ABS	AWG26 L=150	6.9
MP-4-4	AAA (UM4) × 4	ABS	AWG26 L=150	8.0
MP-5-1N	N (UM5) × 1	ABS	AWG26 L=150	2.6
MP-5-2	N (UM5) × 2	ABS	AWG26 L=150	4.7