

PLEASE CHECK WWW.MOLEX.COM FOR LATEST PART INFORMATION

Part Number: [42819-2213](#)
Status: **Active**
Overview: Mini-Fit Sr.™ Power Connectors
Description: 10.00mm Pitch Mini-Fit Sr.™ Header, Single Row, Vertical, 1.57mm PCB Thickness, 0.76µm Gold (Au) Selective Plating, 2 Circuits

Documents:

[3D Model](#) [Product Specification PS-42815-001 \(PDF\)](#)
[Drawing \(PDF\)](#) [RoHS Certificate of Compliance \(PDF\)](#)

Agency Certification

CSA	LR19980
TUV	R72131193
UL	E29179

General

Product Family	PCB Headers
Series	42819
Application	Power, Wire-to-Board
Overview	Mini-Fit Sr.™ Power Connectors
Product Name	Mini-Fit Sr.™
UPC	800756508481

Physical

Breakaway	No
Circuits (Loaded)	2
Circuits (maximum)	2
Color - Resin	Black
Durability (mating cycles max)	100
First Mate / Last Break	No
Flammability	94V-0
Glow-Wire Compliant	No
Guide to Mating Part	No
Keying to Mating Part	None
Lock to Mating Part	Yes
Material - Metal	Brass
Material - Plating Mating	Gold
Material - Plating Termination	Tin
Material - Resin	High Temperature Thermoplastic
Net Weight	5.385/g
Number of Rows	1
Orientation	Vertical
PC Tail Length	3.50mm
PCB Locator	Yes
PCB Retention	Yes
PCB Thickness - Recommended	1.60mm
Packaging Type	Tray
Pitch - Mating Interface	10.00mm
Pitch - Termination Interface	10.00mm
Plating min - Mating	0.762µm
Plating min - Termination	2.540µm
Polarized to Mating Part	Yes
Polarized to PCB	Yes
Shrouded	Fully
Stackable	No
Surface Mount Compatible (SMC)	No

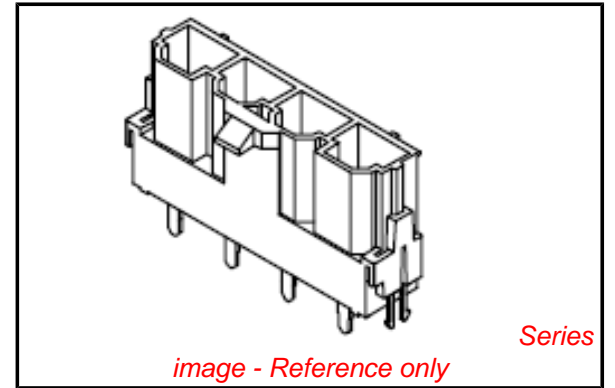

EU RoHS

ELV and RoHS Compliant

REACH SVHC

Not Reviewed

Low-Halogen Status

Not Low-Halogen

China RoHS



Need more information on product environmental compliance?

Email productcompliance@molex.com
 For a multiple part number RoHS Certificate of Compliance, [click here](#)

Please visit the [Contact Us](#) section for any non-product compliance questions.

Search Parts in this Series

[42819Series](#)

Mates With

[42816 Mini-Fit Sr.™ Receptacle Housing with TPA](#)

Temperature Range - Operating -40°C to +105°C
Termination Interface: Style Through Hole

Electrical

Current - Maximum per Contact 50A
Voltage - Maximum 600V

Solder Process Data

Duration at Max. Process Temperature (seconds) 30
Lead-free Process Capability SMC & Wave Capable (TH only)
Max. Cycles at Max. Process Temperature 3
Process Temperature max. C 235

Material Info

Reference - Drawing Numbers

Product Specification PS-42815-001, RPS-42815-011, RPS-42815-012,
RPS-42815-013, RPS-42815-014
Sales Drawing SDA-42819-0002

This document was generated on 01/19/2015

PLEASE CHECK WWW.MOLEX.COM FOR LATEST PART INFORMATION