

KEMET Part Number: SSRH7HS-M08134
(UALSH7SM081340)

KEMET, SSRH7HS-M, AC Line Filters, Common Mode, 0.0134 H

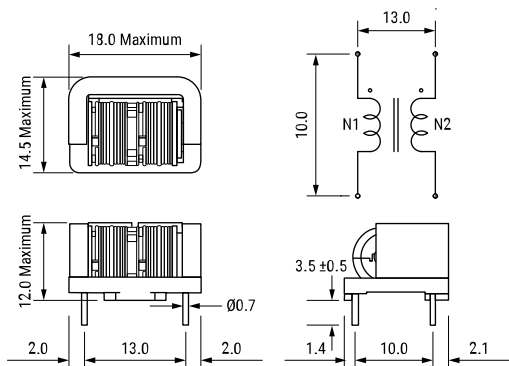

Dimensions

L	18mm MAX
T	14.5mm MAX
H	12mm MAX
LL	3.5mm +/-0.5mm
S	13mm NOM

Packaging Specifications

Packaging:	Tray
Packaging Quantity:	600
Weight:	5.1 g

General Information

Series:	SSRH7HS-M
Style:	Through-Hole
RoHS:	Yes
Notes:	M08 Lot No.
Miscellaneous:	Temperature Rise Maximum: 50 K

Specifications

Voltage AC:	250 VAC
Inductance:	13.4 mH (10 kHz)
Current:	800 mA
Temperature Range:	-25/+120°C
DC Resistance:	500 mOhms