

Breakover Diode Gen¹ (BOD1)

 $V_{BO} = 600-1000 \text{ V}$
 $I_{AVM} = 0.9 \text{ A}$

V_{BO} [V]	Standard Types
600 ±50	IXBOD1-06
700 ±50	IXBOD1-07
800 ±50	IXBOD1-08
900 ±50	IXBOD1-09
1000 ±50	IXBOD1-10

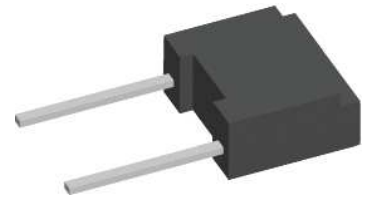

Backside: isolated



Features / Advantages:

- Fast turn on
- Low temperature dependance
- Low leakage current

Applications:

- High voltage circuit protection
- Transient voltage protection
- Trigger device
- Power pulse generators
- Lightning and arcing protection
- Energy discharge circuits
- Battery overvoltage protection
- Solar array protection

Package: FP-Case

- Industry standard outline
- RoHS compliant
- Epoxy meets UL 94V-0
- Soldering pins for PCB mounting
- Base plate: Plastic overmolded tab
- Reduced weight

Disclaimer Notice

Information furnished is believed to be accurate and reliable. However, users should independently evaluate the suitability of and test each product selected for their own applications. Littelfuse products are not designed for, and may not be used in, all applications. Read complete Disclaimer Notice at www.littelfuse.com/disclaimer-electronics.



BOD1			Ratings			
Symbol	Definitions	Conditions	min.	typ.	max.	
I_D	drain current	$V_D = 0.8 \cdot V_{BO}$ $T_{VJ} = 125^\circ\text{C}$			20	μA
V_{BO}	breakover voltage	$V_{BO}(T_{VJ}) = V_{BO,25^\circ\text{C}} [1 + K_T (T_{VJ} - 25^\circ\text{C})]$				V
I_{RMS}	RMS current	$f = 50 \text{ Hz}$ $T_{amb} = 50^\circ\text{C}$ pins soldered to printed circuit (conductor 0.035x2mm)			1.4	A
I_{FAVM}	maximum average forward current				0.9	A
I_{SM}	maximum pulsed source current	$t_p = 0.1 \text{ ms}$; non repetitive $T_{amb} = 50^\circ\text{C}$			200	A
I^2t	I^2t value for fusing	$t_p = 0.1 \text{ ms}$ $T_{amb} = 50^\circ\text{C}$			2	A^2s
K_T	temperature coefficient of V_{BO}				$2 \cdot 10^{-3}$	K^{-1}
K_P	coefficient for energy per pulse EP (material constant)				700	K/Ws
R_{thJA}	thermal resistance junction to ambient	natural convection with air speed 2 m/s			60 45	K/W K/W
I_{BO}	breakover current				15	mA
I_H	holding current				30	mA
V_H	holding voltage		4		8	V
$(dv/dt)_{cr}$	critical rate of rise of voltage	$V_D = 0.67 \cdot (V_{BO} + 100 \text{ V})$ $T_{VJ} = 50^\circ\text{C}$			1000	$\text{V}/\mu\text{s}$
$(di/dt)_{cr}$	critical rate of rise of current	$V_D = V_{BO}$; $I_T = 80 \text{ A}$; $f = 50 \text{ Hz}$ $T_{VJ} = 125^\circ\text{C}$			200	$\text{A}/\mu\text{s}$
t_q	turn-off time	$V_D = 0.67 \cdot V_{BO}$; $V_R = 0 \text{ V}$; $I_T = 80 \text{ A}$ $T_{VJ} = 125^\circ\text{C}$ $dv/dt_{(lin.)} = 200 \text{ V}/\mu\text{s}$; $di/dt = -10 \text{ A}/\mu\text{s}$		150		μs
V_T	forward voltage drop	$I_T = 5 \text{ A}$ $T_{VJ} = 125^\circ\text{C}$			1.7	V
V_{T0}	threshold voltage	for power-loss calculation only $T_{VJ} = 125^\circ\text{C}$			1.1	V
r_T	slope resistance				0.12	Ω

Package FP-Case			Ratings			
Symbol	Definitions	Conditions	min.	typ.	max.	
T _{amb}	ambient temperature (cooling medium)		-40		125	°C
T _{stg}	storage temperature		-40		125	°C
T _{vJM}	maximum virtual junction temperature		-40		125	°C
Weight				0.9		g

Product Marking

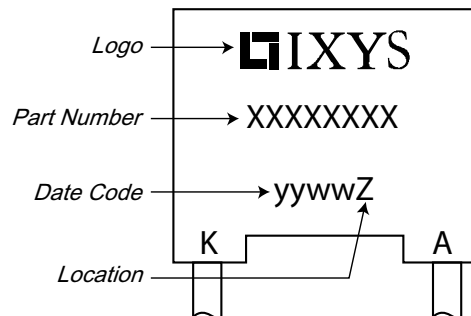

Ordering	Part Name	Marking on Product	Delivering Mode	Base Qty	Ordering Code
Standard	IXBOD1-06	IXBOD1-06	Box	100	467936
Standard	IXBOD1-07	IXBOD1-07	Box	100	478873
Standard	IXBOD1-08	IXBOD1-08	Box	100	467928
Standard	IXBOD1-09	IXBOD1-09	Box	100	474940
Standard	IXBOD1-10	IXBOD1-10	Box	100	467839

Outlines FP-case

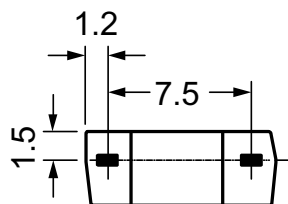
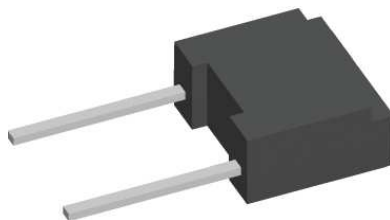

Dimensions in mm
(1 mm = 0.0394")

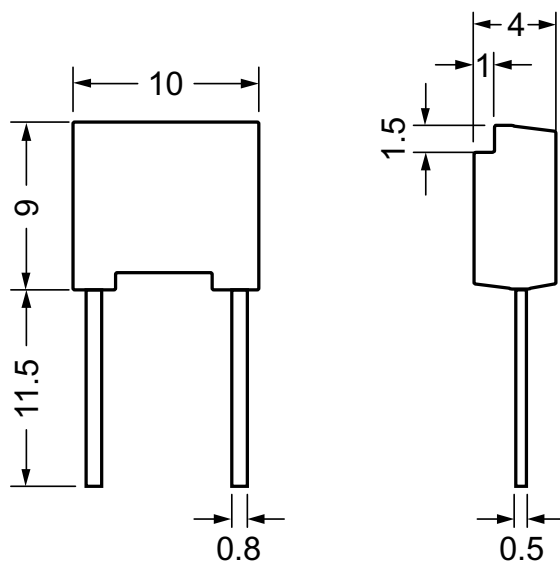

Diode

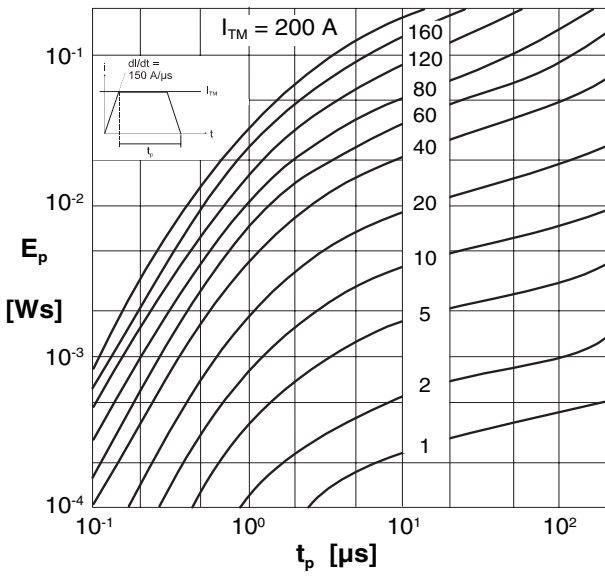

Fig. 1 Energy per pulse for trapezoidal current waveforms (see waveform definition)

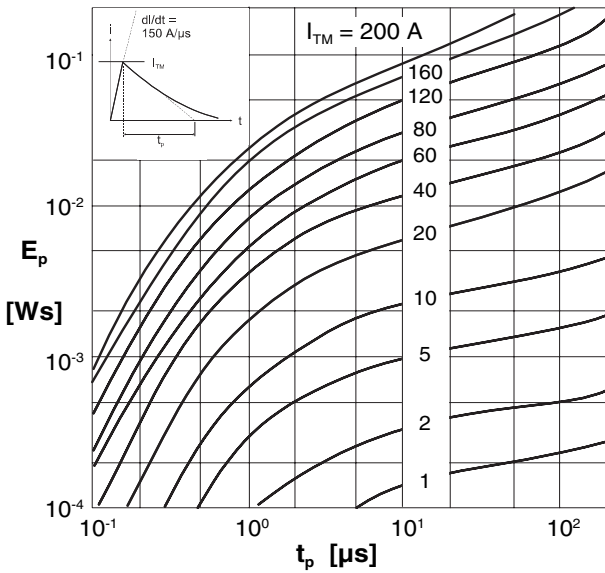

Fig. 2 Energy per pulse for exponentially decaying current pulse (see waveform definition)

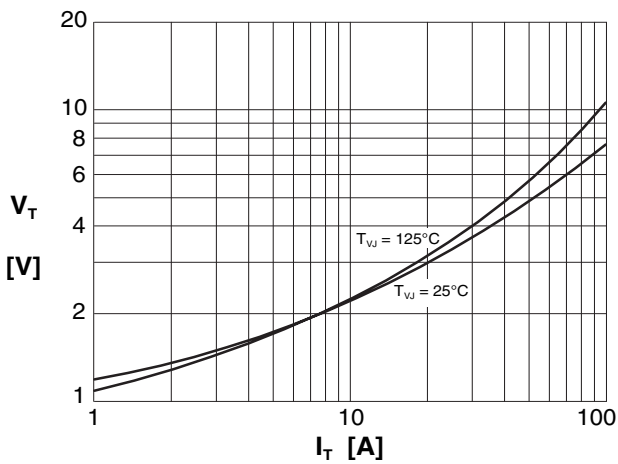

Fig. 3 On-state voltage

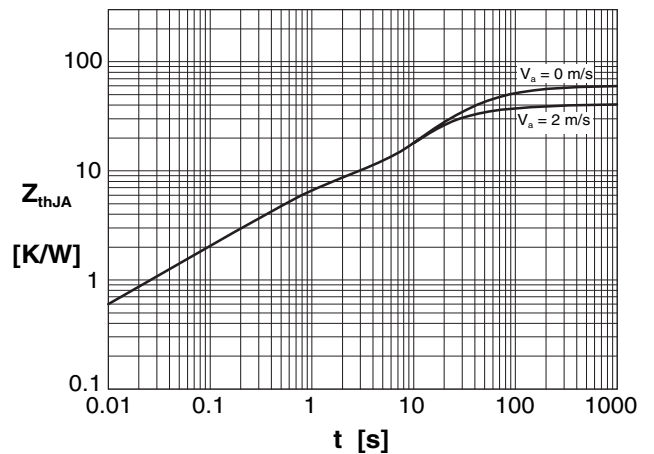

Fig. 4 Transient thermal resistance

Mouser Electronics

Authorized Distributor

Click to View Pricing, Inventory, Delivery & Lifecycle Information:

[IXYS:](#)

[IXBOD1-07](#) [IXBOD1-08](#) [IXBOD1-09](#) [IXBOD1-10](#)