

### FEATURES

#### High Common-Mode Rejection

- DC: 100 dB typ
- 60 Hz: 100 dB typ
- 20 kHz: 70 dB typ
- 40 kHz: 62 dB typ

#### Low Distortion: 0.001% typ

#### Fast Slew Rate: 9.5 V/ $\mu$ s typ

#### Wide Bandwidth: 3 MHz typ

#### Low Cost

#### Complements SSM2142 Differential Line Driver

### APPLICATIONS

- Line Receivers
- Summing Amplifiers
- Buffer Amplifiers—Drives 600  $\Omega$  Load

### GENERAL DESCRIPTION

The SSM2141 is an integrated differential amplifier intended to receive balanced line inputs in audio applications requiring a high level of noise immunity and optimum common-mode rejection. The SSM2141 typically achieves 100 dB of common-mode rejection (CMR), whereas implementing an op amp with four off-the-shelf precision resistors will typically achieve only 40 dB of CMR—inadequate for high-performance audio.

The SSM2141 achieves low distortion performance by maintaining a large slew rate of 9.5 V/ $\mu$ s and high open-loop gain. Distortion is less than 0.002% over the full audio bandwidth. The SSM2141 complements the SSM2142 balanced line driver. Together, these devices comprise a fully integrated solution for equivalent transformer balancing of audio signals without the problems of distortion, EMI fields, and high cost.

Additional applications for the SSM2141 include summing signals, differential preamplifiers, and 600  $\Omega$  low distortion buffer amplifiers. For similar performance with  $G = 1/2$ , see SSM2143.

### FUNCTIONAL BLOCK DIAGRAM

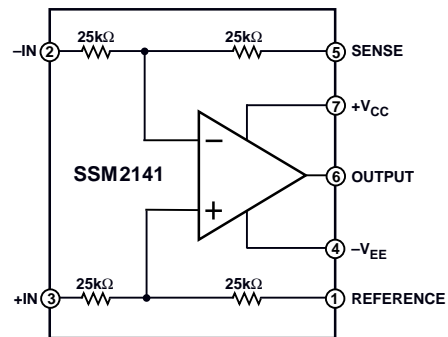

### PIN CONNECTIONS

#### 8-Pin Plastic Mini-DIP (P Suffix)

#### Narrow Body SO (S Suffix)

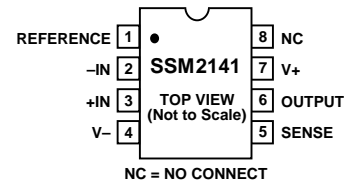

### REV. B

Information furnished by Analog Devices is believed to be accurate and reliable. However, no responsibility is assumed by Analog Devices for its use, nor for any infringements of patents or other rights of third parties which may result from its use. No license is granted by implication or otherwise under any patent or patent rights of Analog Devices.

# SSM2141–SPECIFICATIONS

## ELECTRICAL CHARACTERISTICS (@ $V_S = \pm 18\text{ V}$ , $T_A = +25^\circ\text{C}$ , unless otherwise noted)

Parameter	Symbol	Conditions	SSM2141			Units
			Min	Typ	Max	
OFFSET VOLTAGE	$V_{OS}$	$V_{CM} = 0\text{ V}$	-1000	25	1000	$\mu\text{V}$
GAIN ERROR		No Load, $V_{IN} = \pm 10\text{ V}$ , $R_S = 0\ \Omega$		0.001	0.01	%
INPUT VOLTAGE RANGE	IVR	(Note 1)	$\pm 10$			V
COMMON-MODE REJECTION	CMR	$V_{CM} = \pm 10\text{ V}$	80	100		dB
POWER SUPPLY REJECTION RATIO	PSRR	$V_S = \pm 6\text{ V}$ to $\pm 18\text{ V}$		0.7	15	$\mu\text{V/V}$
OUTPUT SWING	$V_O$	$R_L = 2\text{ k}\Omega$	$\pm 13$	$\pm 14.7$		V
SHORT-CIRCUIT CURRENT LIMIT	$I_{SC}$	Output Shorted to Ground	$+45/-15$			mA
SMALL-SIGNAL BANDWIDTH (-3 dB)	BW	$R_L = 2\text{ k}\Omega$		3		MHz
SLEW RATE	SR	$R_L = 2\text{ k}\Omega$	6	9.5		V/ $\mu\text{s}$
TOTAL HARMONIC DISTORTION	THD	$R_L = 100\text{ k}\Omega$ $R_L = 600\ \Omega$		0.001 0.01		%
CAPACITIVE LOAD DRIVE CAPABILITY	$C_L$	No Oscillation		300		pF
SUPPLY CURRENT	$I_{SY}$	No Load		2.5	3.5	mA

### NOTES

<sup>1</sup>Input Voltage Range Guaranteed by CMR test.

Specifications subject to change without notice

## ELECTRICAL CHARACTERISTICS (@ $V_S = \pm 18\text{ V}$ , $-40^\circ\text{C} \leq T_A \leq +85^\circ\text{C}$ )

Parameter	Symbol	Conditions	Min	Typ	Max	Units
OFFSET VOLTAGE	$V_{OS}$	$V_{CM} = 0\text{ V}$	-2500	200	2500	$\mu\text{V}$
GAIN ERROR		No Load, $V_{IN} = \pm 10\text{ V}$ , $R_S = 0\ \Omega$		0.002	0.02	%
INPUT VOLTAGE RANGE	IVR	(Note 1)	$\pm 10$			V
COMMON-MODE REJECTION	CMR	$V_{CM} = \pm 10\text{ V}$	75	90		dB
POWER SUPPLY REJECTION RATIO	PSRR	$V_S = \pm 6\text{ V}$ to $\pm 18\text{ V}$		1.0	20	$\mu\text{V/V}$
OUTPUT SWING	$V_O$	$R_L = 2\text{ k}\Omega$	$\pm 13$	$\pm 14.7$		V
SLEW RATE	SR	$R_L = 2\text{ k}\Omega$		9.5		V/ $\mu\text{s}$
SUPPLY CURRENT	$I_{SY}$	No Load		2.6	4.0	mA

### NOTES

<sup>1</sup>Input Voltage Range Guaranteed by CMR test.

Specifications subject to change without notice

## ABSOLUTE MAXIMUM RATINGS<sup>1</sup>

Supply Voltage .....	$\pm 18$ V
Input Voltage <sup>1</sup> .....	Supply Voltage
Output Short-Circuit Duration .....	Continuous
Storage Temperature Range	
P Package .....	$-65^{\circ}\text{C}$ to $+150^{\circ}\text{C}$
Lead Temperature (Soldering, 60 sec) .....	$+300^{\circ}\text{C}$
Junction Temperature .....	$+150^{\circ}\text{C}$
Operating Temperature Range .....	$-40^{\circ}\text{C}$ to $+85^{\circ}\text{C}$

Package Type	$\theta_{JA}$ <sup>2</sup>	$\theta_{JC}$	Units
8-Pin Plastic DIP (P)	103	43	$^{\circ}\text{C}/\text{W}$

### NOTES

<sup>1</sup>For supply voltages less than  $\pm 18$  V, the absolute maximum input voltage is equal to the supply voltage.

<sup>2</sup> $\theta_{JA}$  is specified for worst case mounting conditions, i.e.,  $\theta_{JA}$  is specified for device in socket for P-DIP package.

## ORDERING GUIDE

Model	Operating Temperature Range	Package Description	Package Option
SSM2141P	XIND ( $-40^{\circ}\text{C} \leq T_A \leq +85^{\circ}\text{C}$ )	8-Pin Plastic DIP	N-8
SSM2141S	XIND ( $-40^{\circ}\text{C} \leq T_A \leq +85^{\circ}\text{C}$ )	8-Pin Narrow Body SO	SO-8

## Typical Performance Characteristics

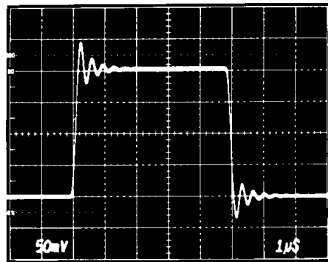

$T_A = +25^{\circ}\text{C}$   
 $V_S = \pm 15\text{V}$

Small Signal Transient Response

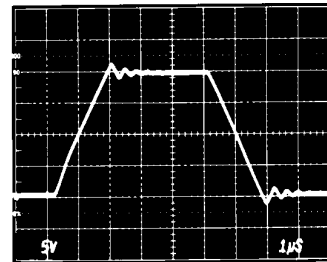

$T_A = +25^{\circ}\text{C}$   
 $V_S = \pm 15\text{V}$

Large Signal Transient Response

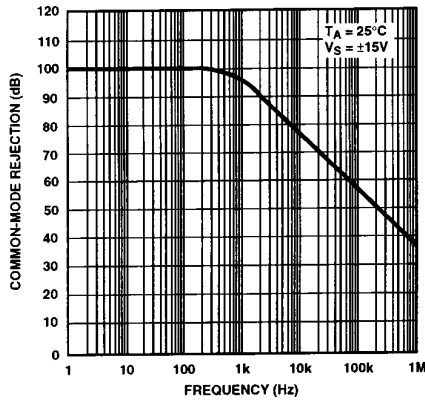

Common-Mode Rejection vs. Frequency

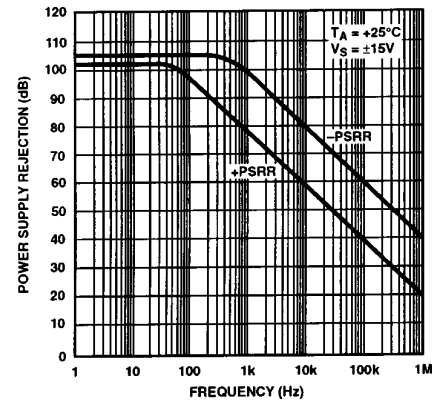

Power Supply Rejection vs. Frequency

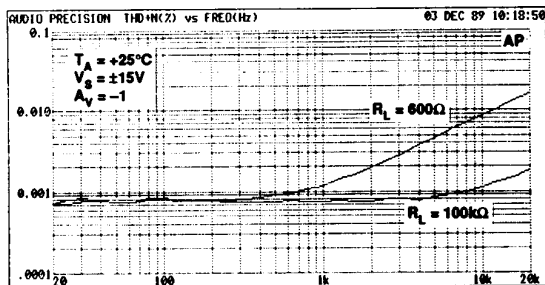

Total Harmonic Distortion vs. Frequency

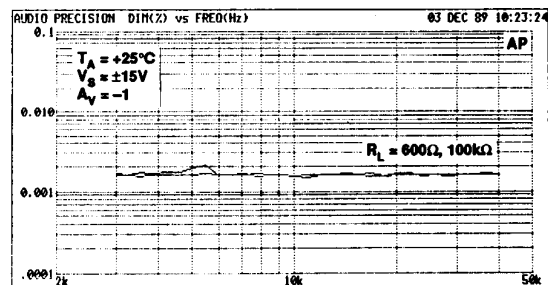

Dynamic Intermodulation Distortion vs. Frequency

# SSM2141—Typical Performance Characteristics

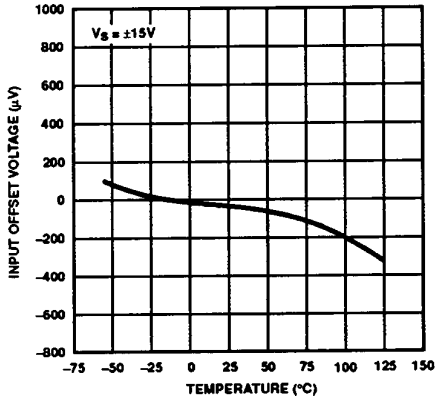

Input Offset Voltage vs. Temperature

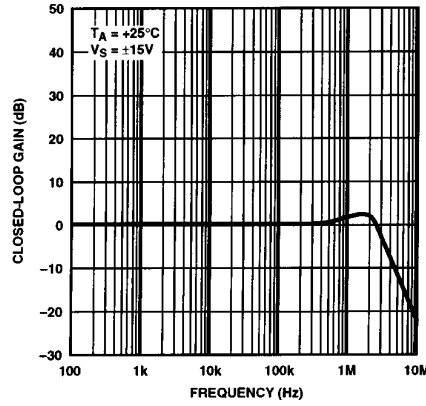

Closed-Loop Gain vs. Frequency

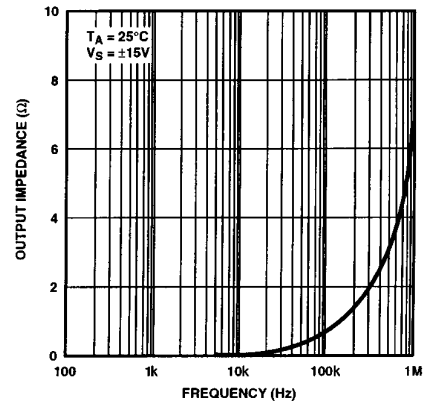

Closed-Loop Output Impedance vs. Frequency

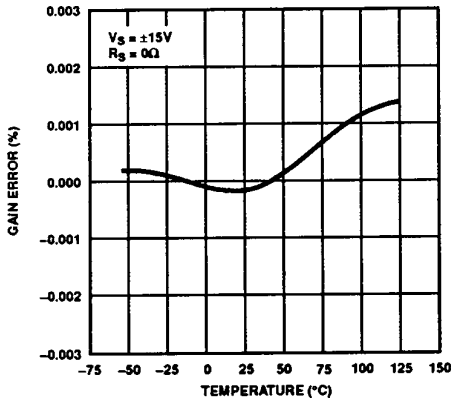

Gain Error vs. Temperature

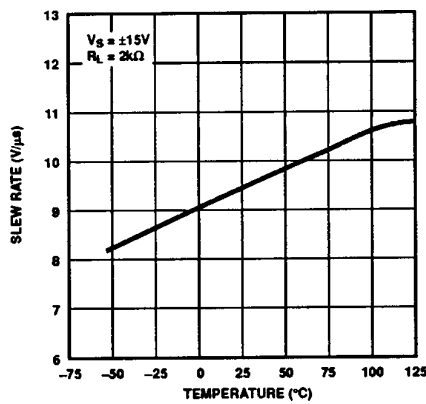

Slew Rate vs. Temperature

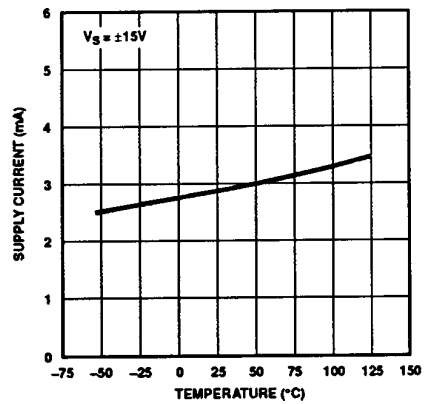

Supply Current vs. Temperature

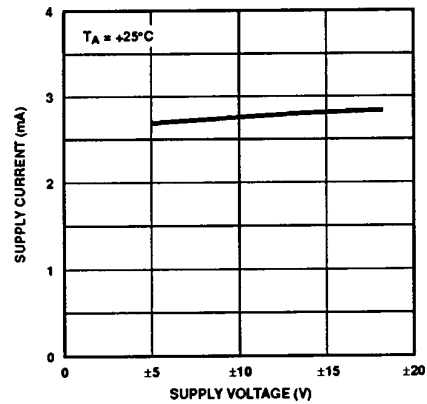

Supply Current vs. Supply Voltage

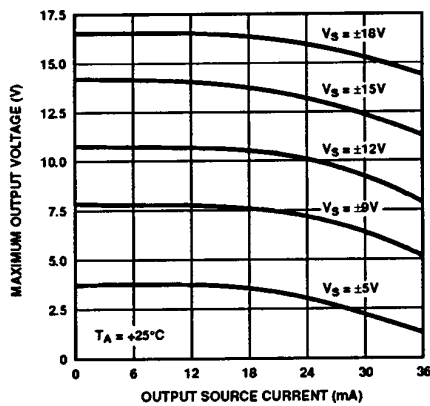

Maximum Output Voltage vs. Output Current (Source)

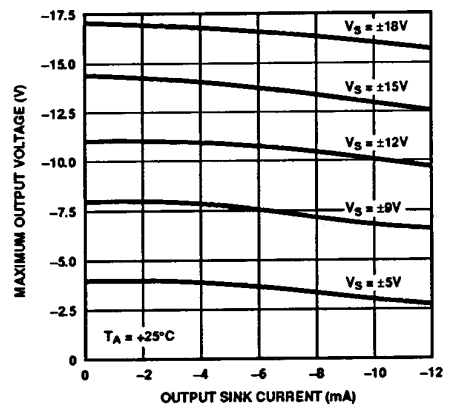

Maximum Output Voltage vs. Output Current (Sink)

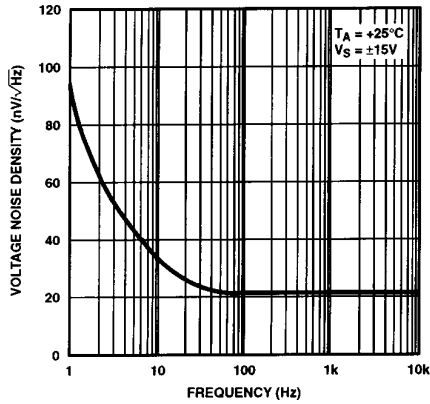

Voltage Noise Density vs. Frequency

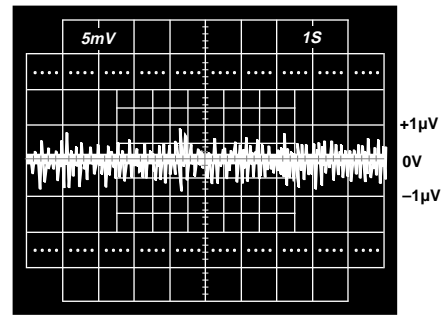

0.1 TO 10Hz PEAK-TO-PEAK NOISE

Low Frequency Voltage Noise

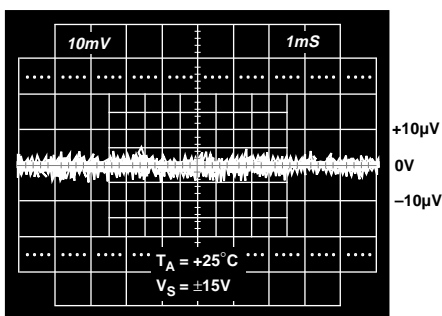

NOTE: EXTERNAL AMPLIFIER GAIN = 1000;  
THEREFORE, VERTICAL SCALE = 10µV/DIV.

Voltage Noise from 0 kHz to 1 kHz

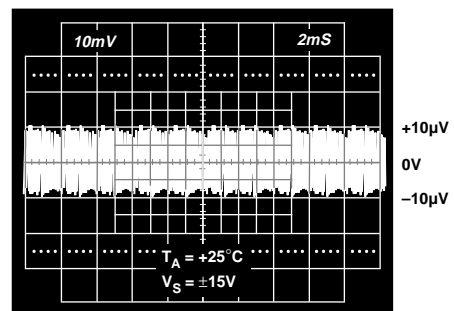

NOTE: EXTERNAL AMPLIFIER GAIN = 1000;  
THEREFORE, VERTICAL SCALE = 10µV/DIV.

Voltage Noise from 0 kHz to 10 kHz

**APPLICATIONS INFORMATION**

The SSM2141 represents a versatile analog building block. In order to capitalize on fast settling time, high slew rate, and high CMR, proper decoupling and grounding techniques must be employed. For decoupling, place 0.1 µF capacitor located within close proximity from each supply pin to ground.

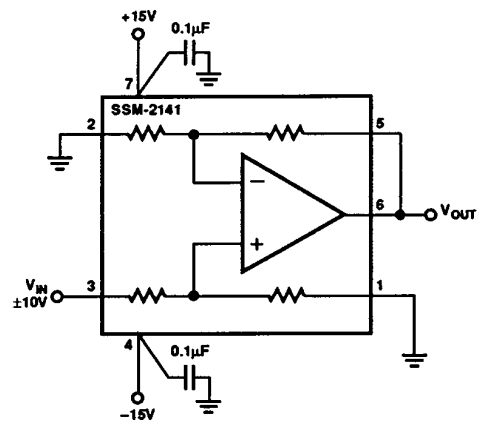

Slew Rate Test Circuit

# SSM2141

## MAINTAINING COMMON-MODE REJECTION

In order to achieve the full common-mode rejection capability of the SSM2141, the source impedance must be carefully controlled. Slight imbalances of the source resistance will result in a degradation of DC CMR—even a 5 Ω imbalance will degrade CMR by 20 dB. Also, the matching of the reactive source impedance must be matched in order to preserve the CMRR over frequency.

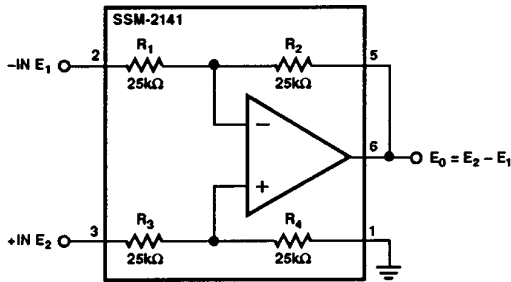

Figure 1. Precision Difference Amplifier. Rejects Common-Mode Signal =  $\frac{[E_1 + E_2]}{2}$  by 100 dB

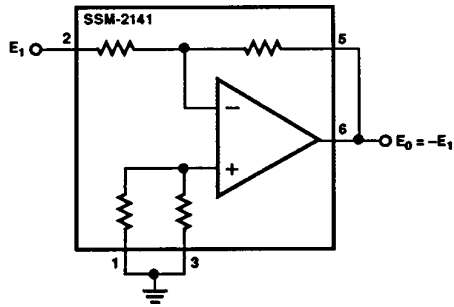

Figure 2. Precision Unity Gain Inverting Amplifier

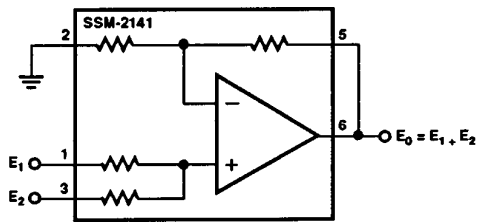

Figure 3. Precision Summing Amplifier

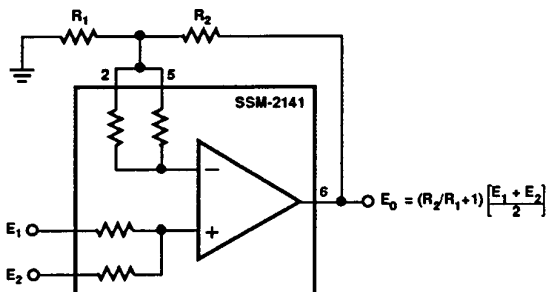

Figure 4. Precision Summing Amplifier with Gain

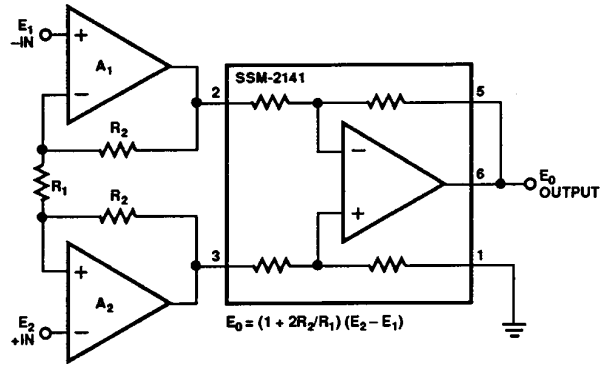
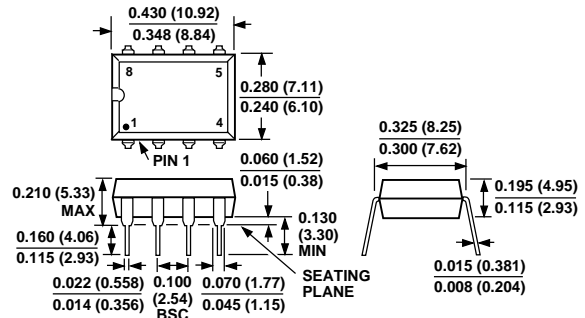

Figure 5. Suitable Instrumentation Amplifier Requirements can be Addressed by Using an Input Stage Consisting of  $A_1$ ,  $A_2$ ,  $R_1$  and  $R_2$

## OUTLINE DIMENSIONS

Dimensions shown in inches and (mm).

### 8-Pin Epoxy Mini-DIP P-Suffix (N-8)



### 8-Pin Narrow Body SO S-Suffix (SO-8)

