

FEATURES

Fast Slew Rate: 22 V/ μ s Typ
Settling Time (0.01%): 1.2 μ s Max
Offset Voltage: 300 μ V Max
High Open-Loop Gain: 1000 V/mV Min
Low Total Harmonic Distortion: 0.002% Typ
Improved Replacement for AD712, LT1057, OP215, TL072, and MC34082

APPLICATIONS

Output Amplifier for Fast D/As
Signal Processing
Instrumentation Amplifiers
Fast Sample/Holds
Active Filters
Low Distortion Audio Amplifiers
Input Buffer for A/D Converters
Servo Controllers

PIN CONNECTIONS

**8-Lead Cerdip (Z Suffix),
8-Lead Plastic Mini-DIP
(P Suffix)**

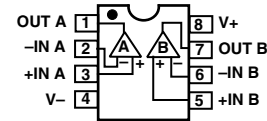

**8-Lead SO
(S Suffix)**

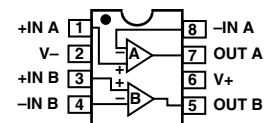

GENERAL DESCRIPTION

The OP249 is a high speed, precision dual JFET op amp, similar to the popular single op amp, the OP42. The OP249 outperforms available dual amplifiers by providing superior speed with excellent dc performance. Ultrahigh open-loop gain (1 kV/mV minimum), low offset voltage, and superb gain linearity makes the OP249 the industry's first true precision, dual high speed amplifier.

With a slew rate of 22 V/ μ s typical and a fast settling time of less than 1.2 μ s maximum to 0.01%, the OP249 is an ideal choice

for high speed bipolar D/A and A/D converter applications. The excellent dc performance of the OP249 allows the full accuracy of high resolution CMOS D/As to be realized.

Symmetrical slew rate, even when driving large load, such as, 600 Ω or 200 pF of capacitance and ultralow distortion, make the OP249 ideal for professional audio applications, active filters, high speed integrators, servo systems, and buffer amplifiers.

The OP249 provides significant performance upgrades to the TL072, AD712, OP215, MC34082, and the LT1057.

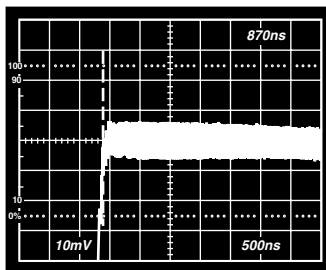

Figure 1. Fast Settling (0.01%)

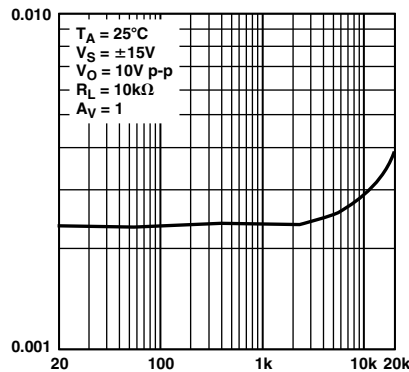

Figure 2. Low Distortion $A_V = 1$,
 $R_L = 10 \text{ k}\Omega$

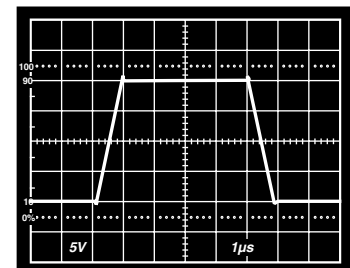

Figure 3. Excellent Output Drive,
 $R_L = 600 \Omega$

REV. E

Information furnished by Analog Devices is believed to be accurate and reliable. However, no responsibility is assumed by Analog Devices for its use, nor for any infringements of patents or other rights of third parties that may result from its use. No license is granted by implication or otherwise under any patent or patent rights of Analog Devices.

OP249—SPECIFICATIONS

ELECTRICAL CHARACTERISTICS (@ $V_S = \pm 15\text{ V}$, $T_A = 25^\circ\text{C}$, unless otherwise noted.)

Parameter	Symbol	Conditions	OP249A			OP249F			Unit
			Min	Typ	Max	Min	Typ	Max	
Offset Voltage	V_{OS}			0.2	0.5		0.2	0.7	mV
Long Term Offset Voltage	V_{OS}	(Note 1)			0.8			1.0	mV
Offset Stability				1.5			1.5		$\mu\text{V}/\text{Month}$
Input Bias Current	I_B	$V_{CM} = 0\text{ V}$, $T_J = 25^\circ\text{C}$		30	75		30	75	pA
Input Offset Current	I_{OS}	$V_{CM} = 0\text{ V}$, $T_J = 25^\circ\text{C}$		6	25		6	25	pA
Input Voltage Range	IVR	(Note 2)		12.5			12.5		V
			± 11			± 11			V
Common-Mode Rejection	CMR	$V_{CM} = \pm 11\text{ V}$		-12.5			-12.5		V
Power-Supply Rejection Ratio	PSRR	$V_S = \pm 4.5\text{ V}$ to $\pm 18\text{ V}$	80	90	31.6	80	90	50	dB
Large-Signal Voltage Gain	A_{VO}	$V_O = \pm 10\text{ V}$, $R_L = 2\text{ k}\Omega$	1000	1400		500	1200		V/mV
Output Voltage Swing	V_O	$R_L = 2\text{ k}\Omega$		12.5			12.5		V
			± 12.0			± 12.0			V
Short-Circuit Current Limit	I_{SC}	Output Shorted to Ground		-12.5			-12.5		V
			± 20	36	± 50	± 20	36	± 50	mA
Supply Current	I_{SY}	No Load, $V_O = 0\text{ V}$		-33	7.0		-33	7.0	mA
Slew Rate	SR	$R_L = 2\text{ k}\Omega$, $C_L = 50\text{ pF}$	18	5.6		18	5.6		$\text{V}/\mu\text{s}$
Gain-Bandwidth Product	GBW	(Note 3)	3.5	22		3.5	22		MHz
Settling Time	t_S	10 V Step 0.01% ⁴		4.7	1.2		4.7	1.2	μs
Phase Margin	θ_0	0 dB Gain		0.9			0.9		Degrees
Differential Input Impedance	Z_{IN}			55			55		Ω
Open-Loop Output Resistance	R_O			$10^{12} 6$			$10^{12} 6$		pF
Voltage Noise	e_n p-p	0.1 Hz to 10 Hz		35			35		Ω
Voltage Noise Density	e_n	$f_0 = 10\text{ Hz}$		2			2		$\mu\text{V p-p}$
		$f_0 = 100\text{ Hz}$		75			75		$\text{nV}/\sqrt{\text{Hz}}$
		$f_0 = 1\text{ kHz}$		26			26		$\text{nV}/\sqrt{\text{Hz}}$
		$f_0 = 10\text{ kHz}$		17			17		$\text{nV}/\sqrt{\text{Hz}}$
		$f_0 = 1\text{ kHz}$		16			16		$\text{nV}/\sqrt{\text{Hz}}$
Current Noise Density	i_n	$f_0 = 1\text{ kHz}$		0.003			0.003		$\text{pA}/\sqrt{\text{Hz}}$
Voltage Supply Range	V_S		± 4.5	± 15	± 18	± 4.5	± 15	± 18	V

NOTES

¹Long-term offset voltage is guaranteed by a 1000 HR life test performed on three independent wafer lots at 125°C with LTPD of three.

²Guaranteed by CMR test.

³Guaranteed by design.

⁴Settling time is sample tested.

Specifications subject to change without notice.

ELECTRICAL CHARACTERISTICS (@ $V_S = \pm 15\text{ V}$, $T_A = 25^\circ\text{C}$, unless otherwise noted.)

Parameter	Symbol	Conditions	OP249G			Unit
			Min	Typ	Max	
Offset Voltage	V_{OS}			0.4	2.0	mV
Input Bias Current	I_B	$V_{CM} = 0\text{ V}$, $T_J = 25^\circ\text{C}$		40	75	pA
Input Offset Current	I_{OS}	$V_{CM} = 0\text{ V}$, $T_J = 25^\circ\text{C}$		10	25	pA
Input Voltage Range	IVR	(Note 1)		12.5		V
			± 11			V
Common-Mode Rejection	CMR	$V_{CM} = \pm 11\text{ V}$		-12.0		V
Power Supply Rejection Ratio	PSRR	$V_S = \pm 4.5\text{ V}$ to $\pm 18\text{ V}$	76	90		dB
Large Signal Voltage Gain	A_{VO}	$V_O = \pm 10\text{ V}$; $R_L = 2\text{ k}\Omega$	500	12	50	$\mu\text{V}/\text{V}$
Output Voltage Swing	V_O	$R_L = 2\text{ k}\Omega$		1100		V/mV
			± 12.0	12.5		V
Short-Circuit Current Limit	I_{SC}	Output Shorted to Ground		-12.5		V
			± 20	36	± 50	mA
Supply Current	I_{SY}	No Load; $V_O = 0\text{ V}$		-33		mA
Slew Rate	SR	$R_L = 2\text{ k}\Omega$, $C_L = 50\text{ pF}$	18	5.6	7.0	mA
Gain Bandwidth Product	GBW	(Note 2)		22		$\text{V}/\mu\text{s}$
Settling Time	t_S	10 V Step 0.01%		4.7	1.2	MHz
Phase Margin	θ_0	0 dB Gain		0.9		μs
Differential Input Impedance	Z_{IN}			55		Degree
				$10^{12} 6$		Ω
						pF

Parameter	Symbol	Conditions	OP249G			Unit
			Min	Typ	Max	
Open Loop Output Resistance	R_O			35		Ω
Voltage Noise	e_n p-p	0.1 Hz to 10 Hz		2		$\mu\text{V p-p}$
Voltage Noise Density	e_n	$f_o = 10 \text{ Hz}$		75		$\text{nV}/\sqrt{\text{Hz}}$
		$f_o = 100 \text{ Hz}$		26		$\text{nV}/\sqrt{\text{Hz}}$
		$f_o = 1 \text{ kHz}$		17		$\text{nV}/\sqrt{\text{Hz}}$
		$f_o = 10 \text{ kHz}$		16		$\text{nV}/\sqrt{\text{Hz}}$
Current Noise Density	i_n	$f_o = 1 \text{ kHz}$		0.003		$\text{pA}/\sqrt{\text{Hz}}$
Voltage Supply Range	V_S		± 4.5	± 15	± 18	V

NOTES

¹Guaranteed by CMR test.

²Guaranteed by design.

Specifications subject to change without notice.

ELECTRICAL CHARACTERISTICS (@ $V_S = \pm 15 \text{ V}$, $-40^\circ\text{C} \leq T_A \leq +85^\circ\text{C}$ for F grades and $-55^\circ\text{C} \leq T_A \leq +125^\circ\text{C}$ for A grade unless otherwise noted.)

Parameter	Symbol	Conditions	OP249A			OP249F			Unit
			Min	Typ	Max	Min	Typ	Max	
Offset Voltage	V_{OS}			0.12	1.0		0.5	1.1	mV
Offset Voltage Temperature Coefficient	TCV_{OS}			1	5		2.2	6	$\mu\text{V}/^\circ\text{C}$
Input Bias Current	I_B	(Note 1)		4	20		0.3	4.0	nA
Input Offset Current	I_{OS}	(Note 1)		0.04	4		0.02	1.2	nA
Input Voltage Range	IVR	(Note 2)		12.5			12.5		V
			± 11			± 11			V
Common-Mode Rejection	CMR	$V_{CM} = \pm 11 \text{ V}$		-12.5			-12.5		V
Power-Supply Rejection Ratio	PSRR	$V_S = \pm 4.5 \text{ V to } \pm 18 \text{ V}$		76	110		80	90	dB
Large-Signal Voltage Gain	A_{VO}	$R_L = 2 \text{ k}\Omega$; $V_O = \pm 10 \text{ V}$		5	50		7	100	$\mu\text{V}/\text{V}$
Output Voltage Swing	V_O	$R_L = 2 \text{ k}\Omega$		500	1400		250	1200	V/mV
				12.5			12.5		V
			± 12			± 12			V
Short-Circuit Current Limit	I_{SC}	Output Shorted to Ground		-12.5			-12.5		V
Supply Current	I_{SY}	No Load, $V_O = 0 \text{ V}$		± 10	± 60		± 18	± 60	mA
				5.6	7.0		5.6	7.0	mA

NOTES

¹ $T_J = 85^\circ\text{C}$ for F Grades; $T_J = 125^\circ\text{C}$ for A Grade.

²Guaranteed by CMR test.

Specifications subject to change without notice.

ELECTRICAL CHARACTERISTICS (@ $V_S = \pm 15 \text{ V}$, $-40^\circ\text{C} \leq T_A \leq +85^\circ\text{C}$ for unless otherwise noted.)

Parameter	Symbol	Conditions	OP249G			Unit
			Min	Typ	Max	
Offset Voltage	V_{OS}			1.0	3.6	mV
Offset Voltage Temperature Coefficient	TCV_{OS}			6	25	$\mu\text{V}/^\circ\text{C}$
Input Bias Current	I_B	(Note 1)		0.5	4.5	nA
Input Offset Current	I_{OS}	(Note 1)		0.04	1.5	nA
Input Voltage Range	IVR	(Note 2)		12.5		V
			± 11			V
Common-Mode Rejection	CMR	$V_{CM} = \pm 11 \text{ V}$		-12.5		V
Power-Supply Rejection Ratio	PSRR	$V_S = \pm 4.5 \text{ V to } \pm 18 \text{ V}$		76	95	dB
Large-Signal Voltage Gain	A_{VO}	$R_L = 2 \text{ k}\Omega$; $V_O = \pm 10 \text{ V}$		10	100	$\mu\text{V}/\text{V}$
Output Voltage Swing	V_O	$R_L = 2 \text{ k}\Omega$		250	1200	V/mV
				12.5		V
			± 12.0			V
Short-Circuit Current Limit	I_{SC}	Output Shorted to Ground		-12.5		V
Supply Current	I_{SY}	No Load, $V_O = 0 \text{ V}$		± 18	± 60	mA
				5.6	7.0	mA

NOTES

¹ $T_J = 85^\circ\text{C}$.

²Guaranteed by CMR test.

Specifications subject to change without notice.

OP249

ABSOLUTE MAXIMUM RATINGS¹

Supply Voltage	±18 V
Input Voltage ²	±18 V
Differential Input Voltage ²	36 V
Output Short-Circuit Duration	Indefinite
Storage Temperature Range	-65°C to +175°C
Operating Temperature Range	
OP249A (Z)	-55°C to +125°C
OP249E, F (Z)	-40°C to +85°C
OP249G (P, S)	-40°C to +85°C
Junction Temperature	
OP249 (Z)	-65°C to +175°C
OP249 (P, S)	-65°C to +150°C
Lead Temperature Range (Soldering, 60 sec)	300°C

Package Type	θ_{JA} ³	θ_{JC}	Unit
8-Lead Hermetic DIP (Z)	134	12	°C/W
8-Lead Plastic DIP (P)	96	37	°C/W
8-Lead SO (S)	150	41	°C/W

NOTES

¹Absolute maximum ratings apply to packaged parts, unless otherwise noted.

²For supply voltages less than ±18 V, the absolute maximum input voltage is equal to the supply voltage.

³ θ_{JA} is specified for worst-case mounting conditions, i.e., θ_{JA} is specified for device in socket for cerdip and P-DIP packages; θ_{JA} is specified for device soldered to printed circuit board for SO package.

ORDERING GUIDE*

Model	Temperature Range	Package Descriptions	Package Options
OP249AZ	-55°C to +125°C	8-Lead Cerdip	Q-8
OP249FZ	-40°C to +85°C	8-Lead Cerdip	Q-8
OP249GP	-40°C to +85°C	8-Lead Plastic DIP	N-8
OP249GS*	-40°C to +85°C	8-Lead SO	SO-8
OP249GS-REEL	-40°C to +85°C	8-Lead SO	SO-8
OP249GS-REEL7	-40°C to +85°C	8-Lead SO	SO-8

NOTES

*For availability and burn-in information on SO and PLCC packages, contact your local sales office.

For Military processed devices, please refer to the Standard Microcircuit Drawing (SMD) available at www.dscc.dla.mil/programs/milspec/default.asp

SMD Part Number	ADI Equivalent
5962-9151901M2A	OP249ARCMDA
5962-9151901MGA	OP249AJMDA
5962-9151901MPA	OP249AZMDA

CAUTION

ESD (electrostatic discharge) sensitive device. Electrostatic charges as high as 4000 V readily accumulate on the human body and test equipment and can discharge without detection. Although the OP249 features proprietary ESD protection circuitry, permanent damage may occur on devices subjected to high-energy electrostatic discharges. Therefore, proper ESD precautions are recommended to avoid performance degradation or loss of functionality.



Typical Performance Characteristics—OP249

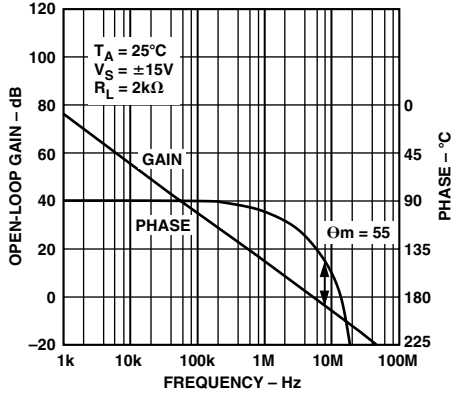

TPC 1. Open-Loop Gain, Phase vs. Frequency

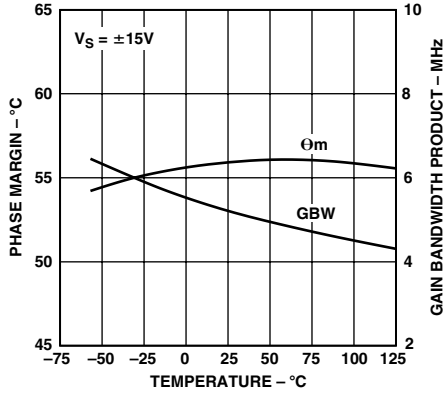

TPC 2. Gain Bandwidth Product, Phase Margin vs. Temperature

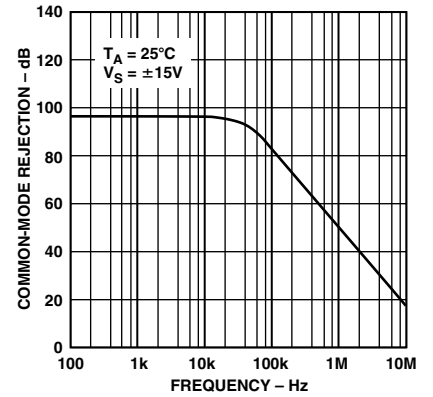

TPC 3. Common-Mode Rejection vs. Frequency

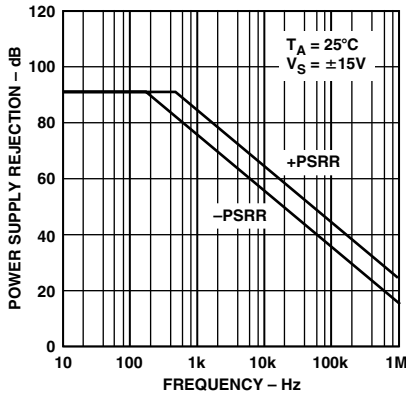

TPC 4. Power Supply Rejection vs. Frequency

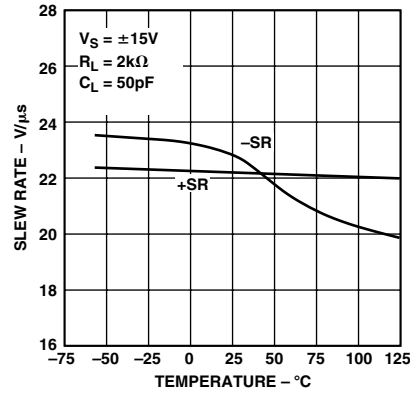

TPC 5. Slew Rate vs. Temperature

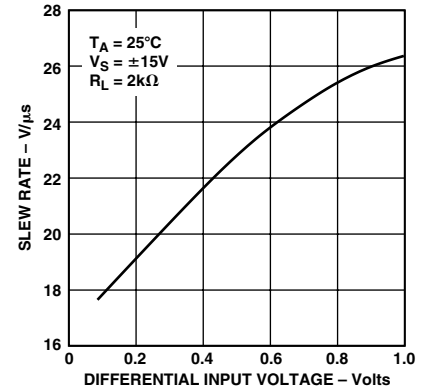

TPC 6. Slew Rate vs. Differential Input Voltage

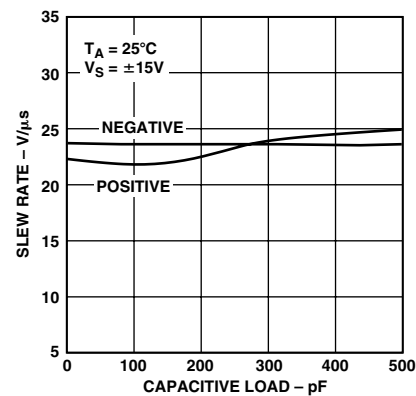

TPC 7. Slew Rate vs. Capacitive Load

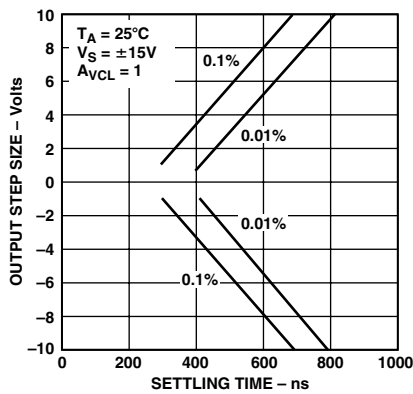

TPC 8. Settling Time vs. Step Size

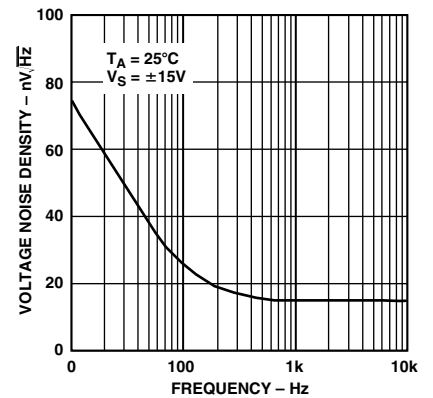

TPC 9. Voltage Noise Density vs. Frequency

OP249

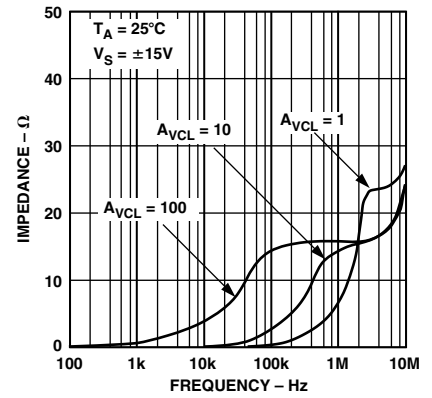
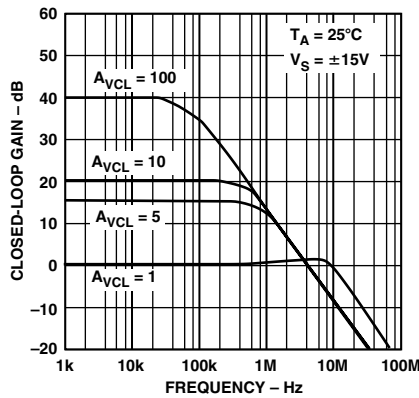
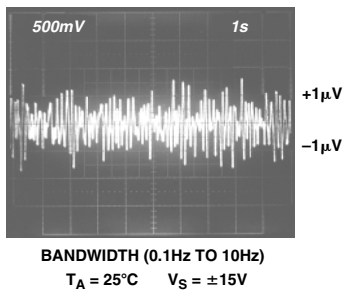
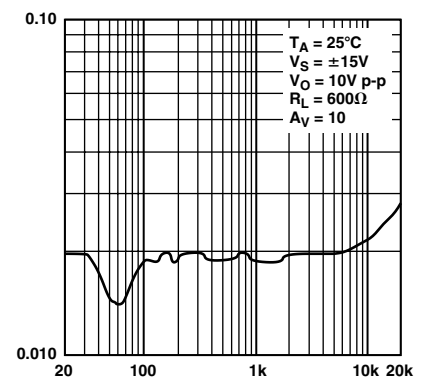
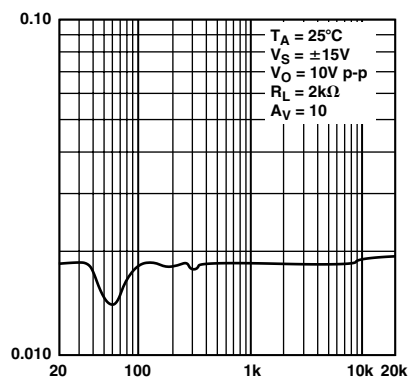
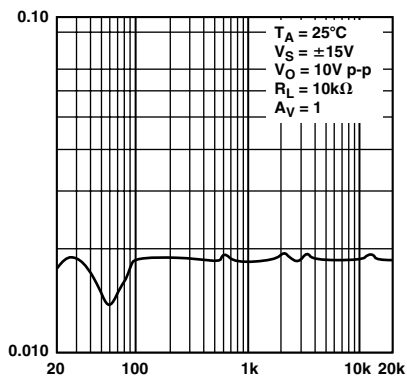
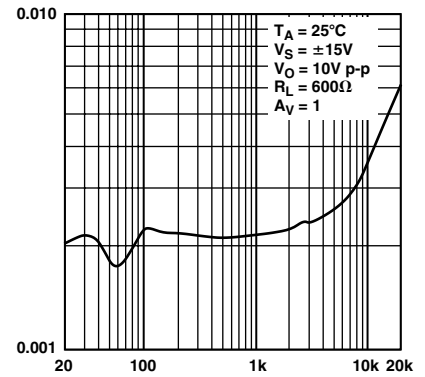
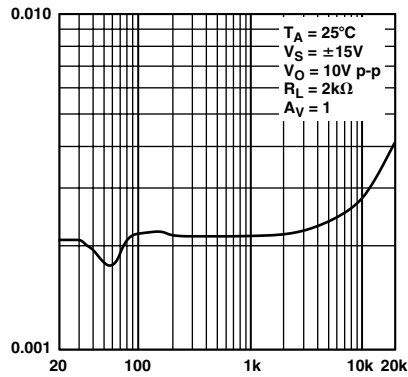
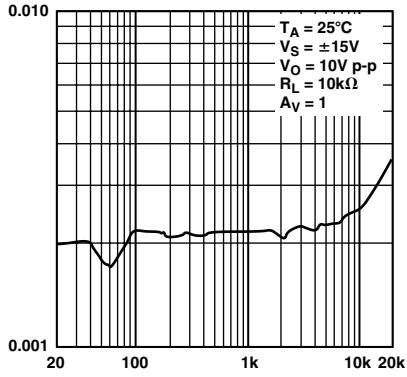

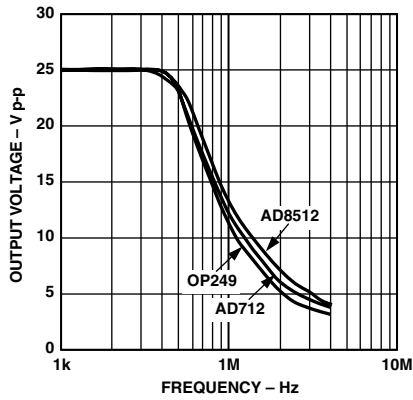

TPC 19. Output Voltage vs. Frequency

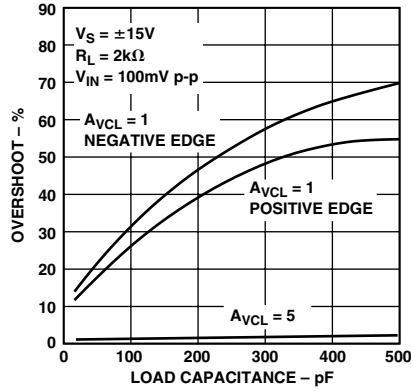

TPC 20. Small Overshoot vs. Load Capacitance

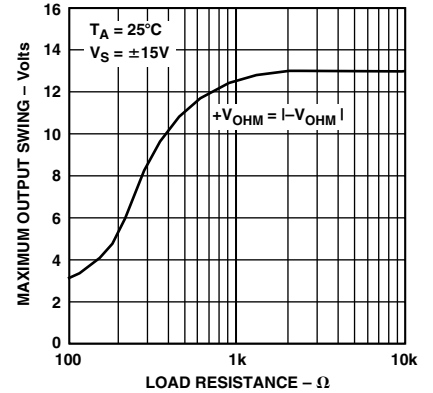

TPC 21. Maximum Output Voltage vs. Load Resistance

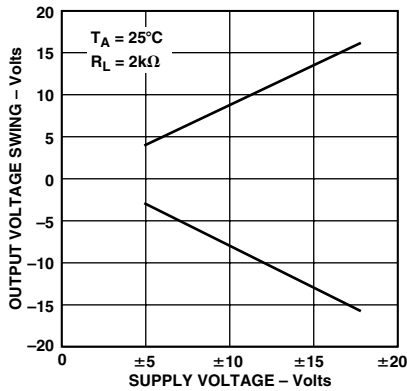

TPC 22. Output Voltage Swing vs. Supply Voltage

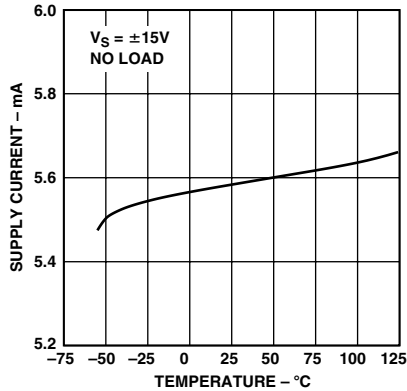

TPC 23. Supply Current vs. Temperature

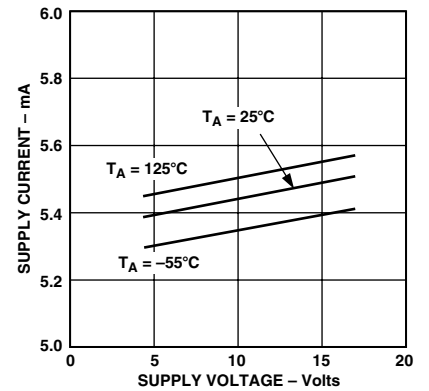

TPC 24. Supply Current vs. Supply Voltage

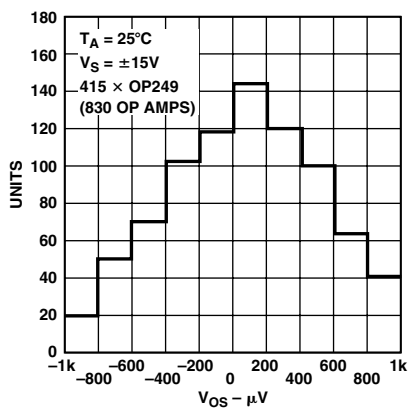

TPC 25. V_{OS} Distribution (P Package)

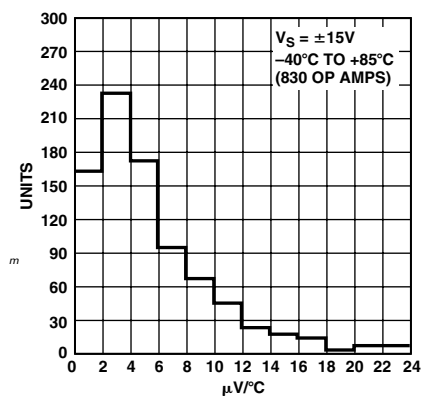

TPC 26. TCV_{OS} Distribution (P Package)

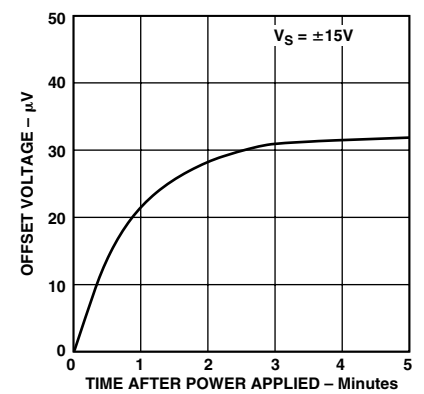

TPC 27. Offset Voltage Warm-Up Drift

OP249

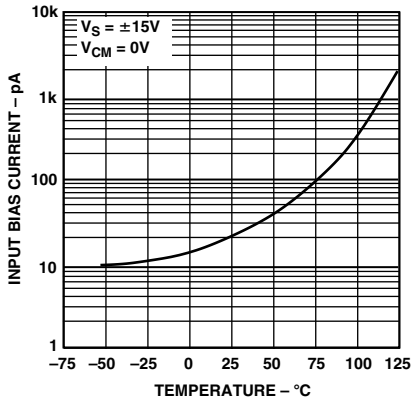

TPC 28. Input Bias Current vs. Temperature

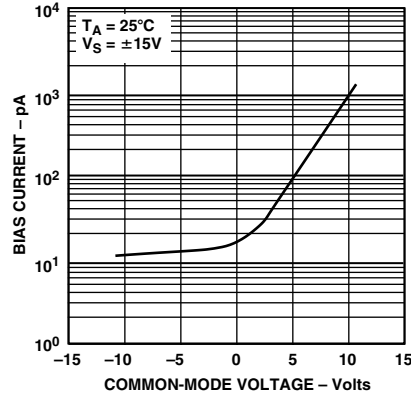

TPC 29. Bias Current vs. Common-Mode Voltage

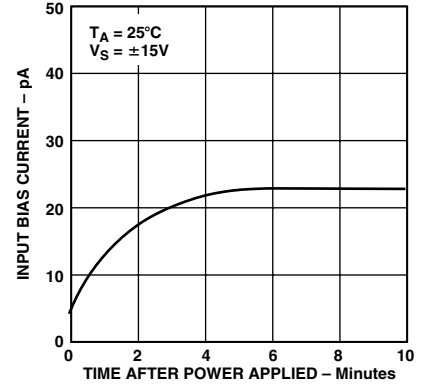

TPC 30. Bias Current Warm-Up Drift

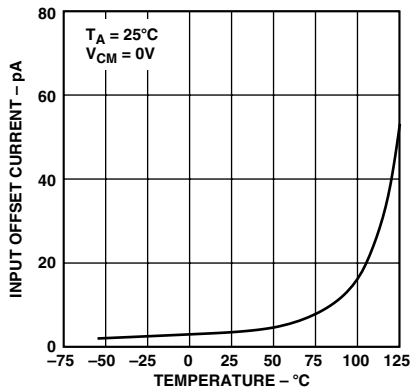

TPC 31. Input Offset Current vs. Temperature

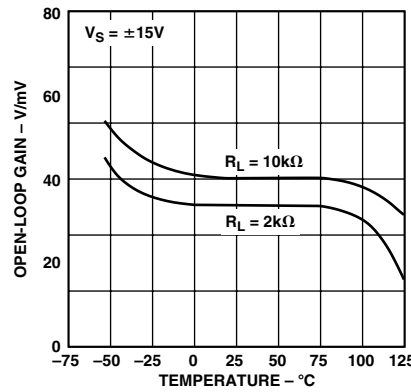

TPC 32. Open-Loop Gain vs. Temperature

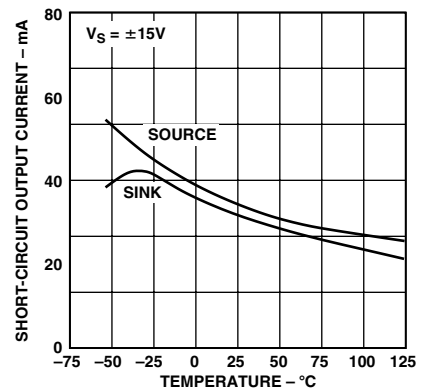

TPC 33. Short-Circuit Output Current vs. Junction Temperature

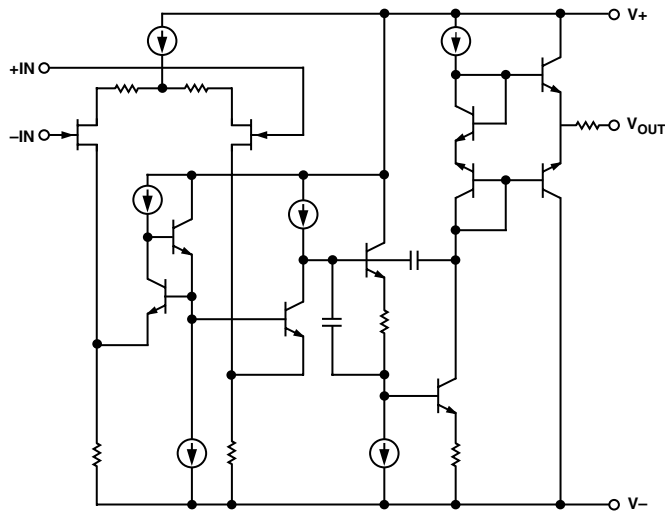

Figure 4. Simplified Schematic (1/2 OP249)

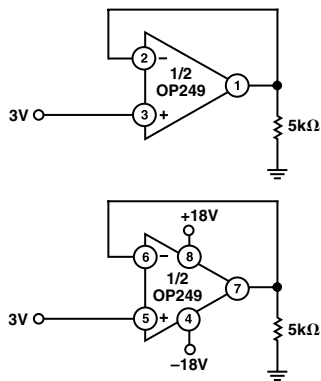
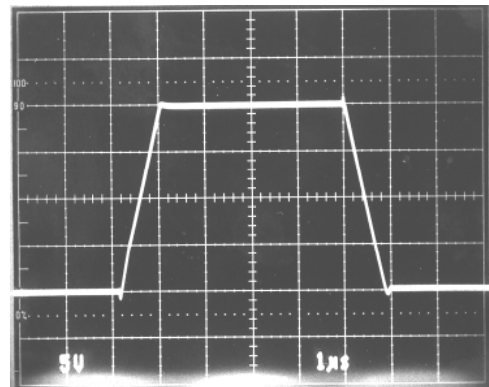

Figure 5. Burn-In Circuit

APPLICATIONS INFORMATION

The OP249 represents a reliable JFET amplifier design, featuring an excellent combination of dc precision and high speed. A rugged output stage provides the ability to drive a 600 Ω load and still maintain a clean ac response. The OP249 features a large signal response that is more linear and symmetric than previously available JFET input amplifiers—compare the OP249’s large-signal response, as illustrated in Figure 6, to other industry standard dual JFET amplifiers.

Typically, JFET amplifier’s stinging performance is simply specified as just a number of volts/μs. There is no discussion on the quality, i.e., linearity, symmetry, etc., of the stinging response.



A) OP249

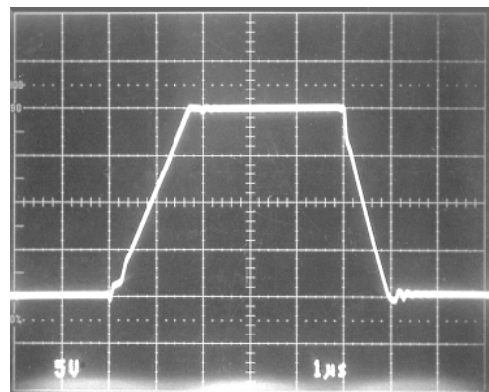

B) LT1057

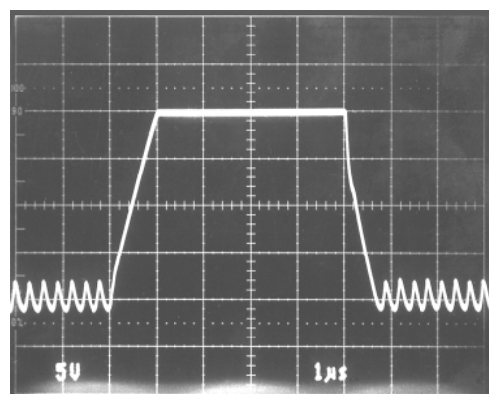

C) AD712

Figure 6. Large-Signal Transient Response, $A_V = 1$, $V_{IN} = 20\text{ V p-p}$, $Z_L = 2\text{ k}\Omega/200\text{ pF}$, $V_S = \pm 15\text{ V}$

OP249

The OP249 was carefully designed to provide symmetrically matched slew characteristics in both the negative and positive directions, even when driving a large output load.

An amplifier's slewing limitation determines the maximum frequency at which a sinusoidal output can be obtained without significant distortion. It is, however, important to note that the nonsymmetric slewing typical of previously available JFET amplifiers adds a higher series of harmonic energy content to the resulting response—and an additional dc output component. Examples of potential problems of nonsymmetric slewing behavior could be in audio amplifier applications, where a natural low distortion sound quality is desired, and in servo or signal processing systems where a net dc offset cannot be tolerated. The linear and symmetric slewing feature of the OP249 makes it an ideal choice for applications that will exceed the full-power bandwidth range of the amplifier.

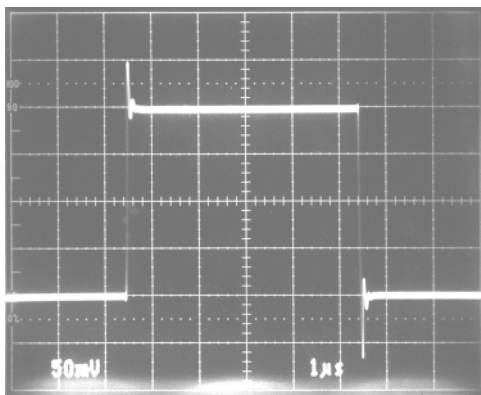

Figure 7. Small-Signal Transient Response, $A_V = 1$, $Z_L = 2\text{ k}\Omega \parallel 100\text{ pF}$, No Compensation, $V_S = \pm 15\text{ V}$

As with most JFET-input amplifiers, the output of the OP249 may undergo phase inversion if either input exceeds the specified input voltage range. Phase inversion will not damage the amplifier, nor will it cause an internal latch-up condition.

Supply decoupling should be used to overcome inductance and resistance associated with supply lines to the amplifier. A $0.1\text{ }\mu\text{F}$ and a $10\text{ }\mu\text{F}$ capacitor should be placed between each supply pin and ground.

OPEN-LOOP GAIN LINEARITY

The OP249 has both an extremely high open-loop gain of 1 kV/mV minimum and constant gain linearity. This feature of the OP249 enhances its dc precision, and provides superb accuracy in high closed-loop gain applications. Figure 8 illustrates the typical open-loop gain linearity—high gain accuracy is assured, even when driving a $600\text{ }\Omega$ load.

OFFSET VOLTAGE ADJUSTMENT

The inherent low offset voltage of the OP249 will make offset adjustments unnecessary in most applications. However, where a lower offset error is required, balancing can be performed with simple external circuitry, as illustrated in Figures 9 and 10.

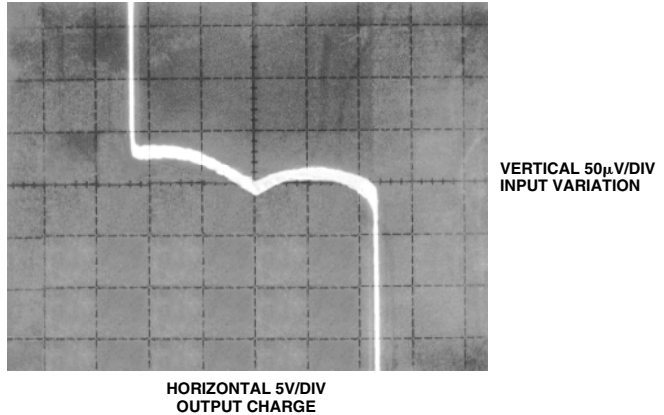

Figure 8. Open-Loop Gain Linearity. Variation in Open-Loop Gain Results in Errors in High Closed-Loop Gain Circuits. $R_L = 600\text{ }\Omega$, $V_S = \pm 15\text{ V}$

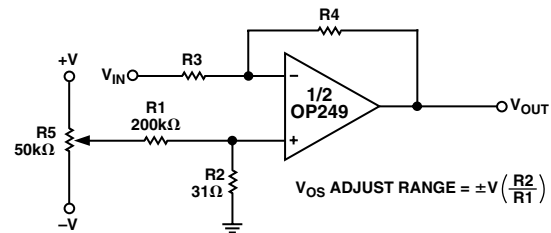

Figure 9. Offset Adjust for Inverting Amplifier Configuration

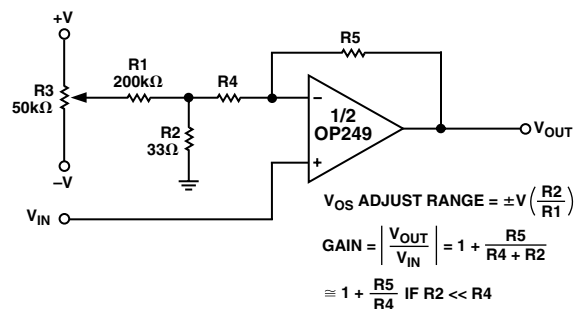

Figure 10. Offset Adjust for Noninverting Amplifier Configuration

In Figure 9, the offset adjustment is made by supplying a small voltage at the noninverting input of the amplifier. Resistors R1 and R2 attenuates the pot voltage, providing a $\pm 2.5\text{ mV}$ (with $V_S = \pm 15\text{ V}$) adjustment range, referred to the input. Figure 10 illustrates offset adjust for the noninverting amplifier configuration, also providing a $\pm 2.5\text{ mV}$ adjustment range. As indicated in the equations in Figure 10, if R4 is not much greater than R2, there will be a resulting closed-loop gain error that must be accounted for.

SETTLING TIME

Settling time is the time between when the input signal begins to change and when the output permanently enters a prescribed error band. The error bands on the output are 5 mV and 0.5 mV, respectively, for 0.1% and 0.01% accuracy.

Figure 11 illustrates the OP249's typical settling time of 870 ns. Moreover, problems in settling response, such as thermal tails and long-term ringing are nonexistent.

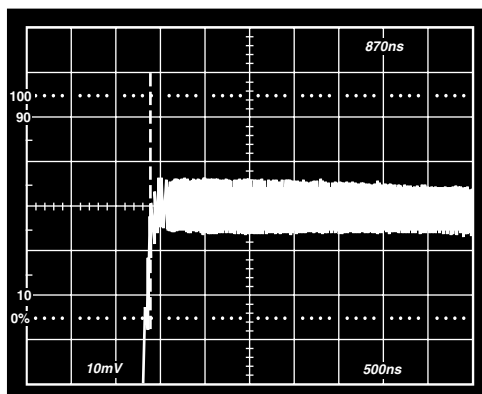

Figure 11. Settling Characteristics of the OP249 to 0.01%

DAC OUTPUT AMPLIFIER

Unity-gain stability, a low offset voltage of 300 μ V typical, and a fast settling time of 870 ns to 0.01%, makes the OP249 an ideal amplifier for fast digital-to-analog converters.

For CMOS DAC applications, the low offset voltage of the OP249 results in excellent linearity performance. CMOS DACs, such as the PM-7545, will typically have a code-dependent output resistance variation between 11 k Ω and 33 k Ω . The change in output resistance, in conjunction with the 11 k Ω feedback resistor, will result in a noise gain change. This causes variations in the offset error, increasing linearity errors. The OP249 features low offset voltage error, minimizing this effect and maintaining 12-bit linearity performance over the full-scale range of the converter.

Since the DAC's output capacitance appears at the operational amplifiers inputs, it is essential that the amplifier is adequately compensated. Compensation will increase the phase margin, and ensure an optimal overall settling response. The required lead compensation is achieved with Capacitor C in Figure 12.

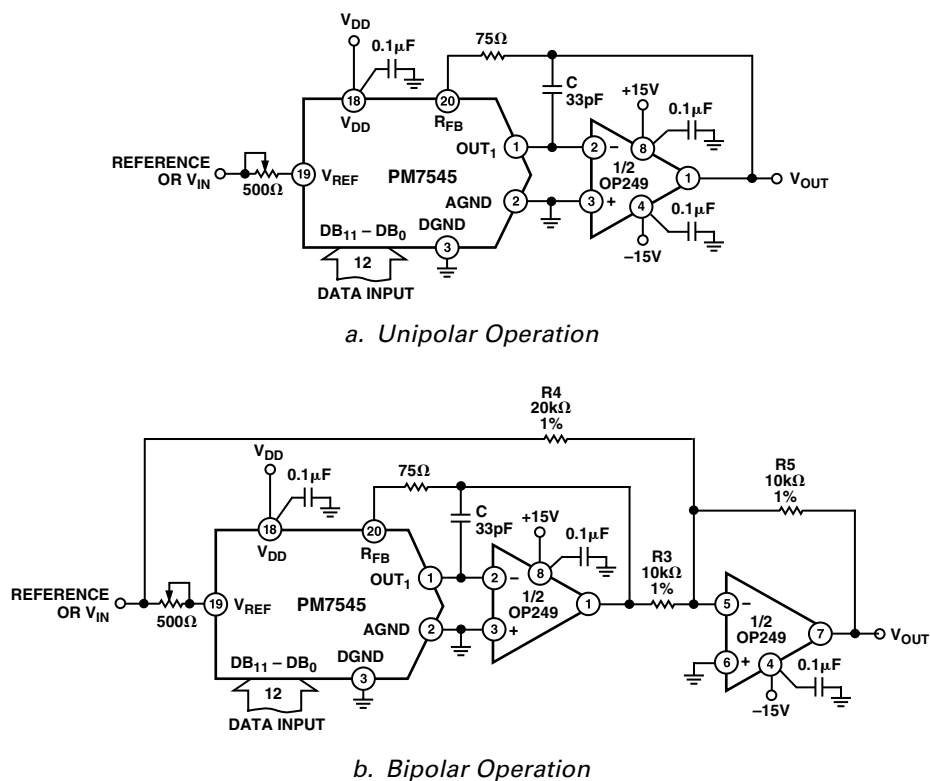

Figure 12. Fast Settling and Low Offset Error of the OP249 Enhances CMOS DAC Performance

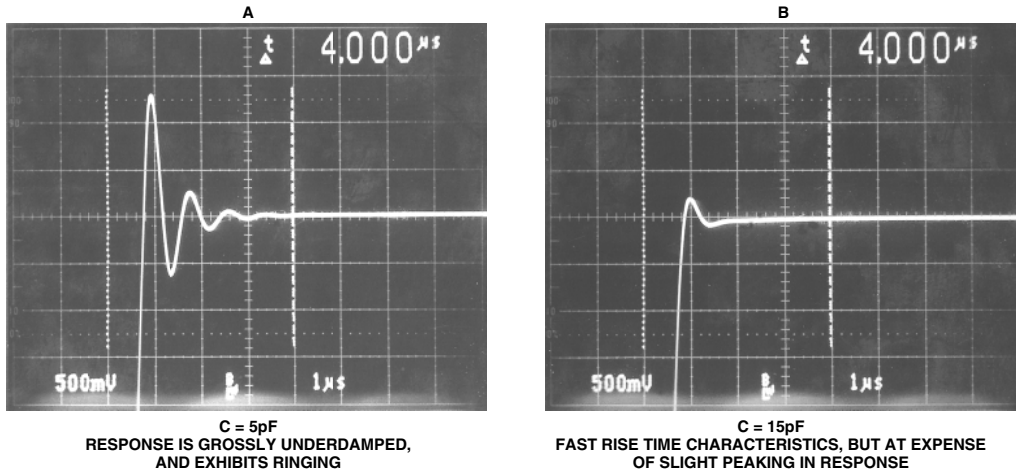

Figure 13. Effect of Altering Compensation from Circuit in Figure 12a—PM7545 CMOS DAC with 1/2 OP249, Unipolar Operation. Critically Damped Response Will Be Obtained with $C \approx 33$ pF.

Figure 13 illustrates the effect of altering the compensation on the output response of the circuit in Figure 12a. Compensation is required to address the combined effect of the DAC’s output capacitance, the op amp’s input capacitance and any stray capacitance. Slight adjustments to the compensation capacitor may be required to optimize settling response for any given application. The settling time of the combination of the current output DAC and the op amp can be approximated by:

$$t_s \text{ TOTAL} = \sqrt{(t_s \text{ DAC})^2 + (t_s \text{ AMP})^2}$$

The actual overall settling time is affected by the noise gain of the amplifier, the applied compensation, and the equivalent input capacitance at the amplifier’s input.

DISCUSSION ON DRIVING A/D CONVERTERS

Settling characteristics of operational amplifiers also include an amplifier’s ability to recover, i.e., settle, from a transient current output load condition. An example of this includes an op amp driving the input from a SAR type A/D converter. Although the comparison point of the converter is usually diode clamped, the input swing of plus-and-minus a diode drop still gives rise to a significant modulation of input current. If the closed-loop output impedance is low enough and bandwidth of the amplifier is sufficiently large, the output will settle before the converter makes a comparison decision which will prevent linearity errors or missing codes.

Figure 14 shows a settling measurement circuit for evaluating recovery from an output current transient. An output disturbing current generator provides the transient change in output load current of 1 mA. As seen in Figure 15, the OP249 has extremely fast recovery of 274 ns (to 0.01%), for a 1 mA load transient. The performance makes it an ideal amplifier for data acquisition systems.

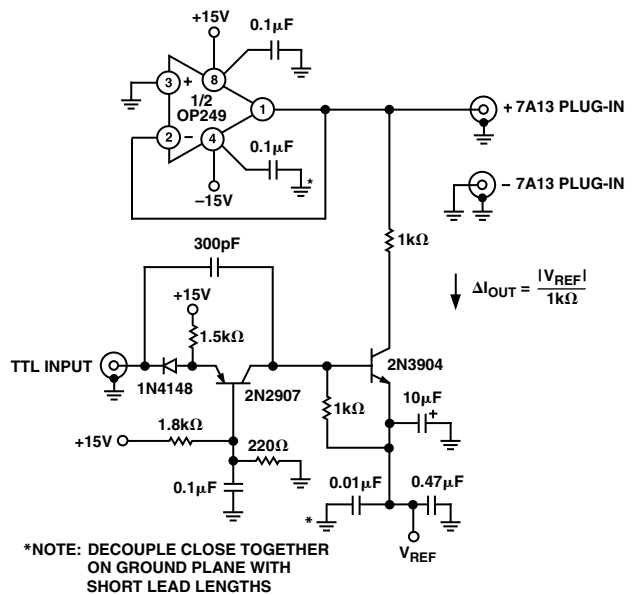

Figure 14. Transient Output Impedance Test Fixture

The combination of high speed and excellent dc performance of the OP249 makes it an ideal amplifier for 12-bit data acquisition systems. Examining the circuit in Figure 16, one amplifier in the OP249 provides a stable -5 V reference voltage for the V_{REF} input of the ADC912. The other amplifier in the OP249 performs high speed buffering of the A/D’s input.

Examining the worst case transient voltage error (Figure 17) at the Analog In node of the A/D converter: the OP249 recovers in less than 100 ns. The fast recovery is due to both the OP249’s wide bandwidth and low dc output impedance.

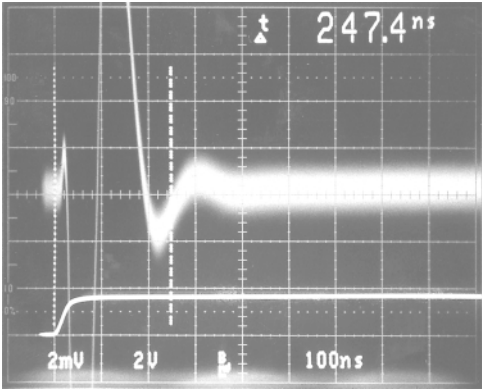

Figure 15. OP249's Transient Recovery Time from a 1 mA Load Transient to 0.01%

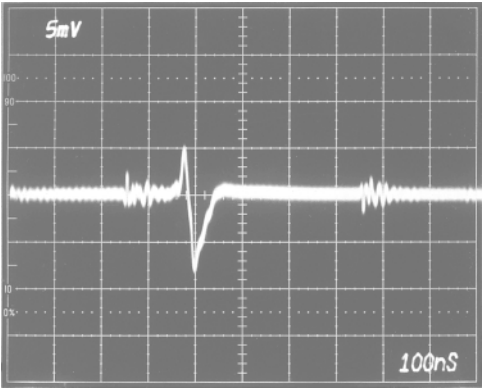

Figure 17. Worst-Case Transient Voltage, at Analog In, Occurs at the Half-Scale Point of the A/D. OP249 Buffers the A/D Input from Figure 16, and Recovers in Less than 100 ns.

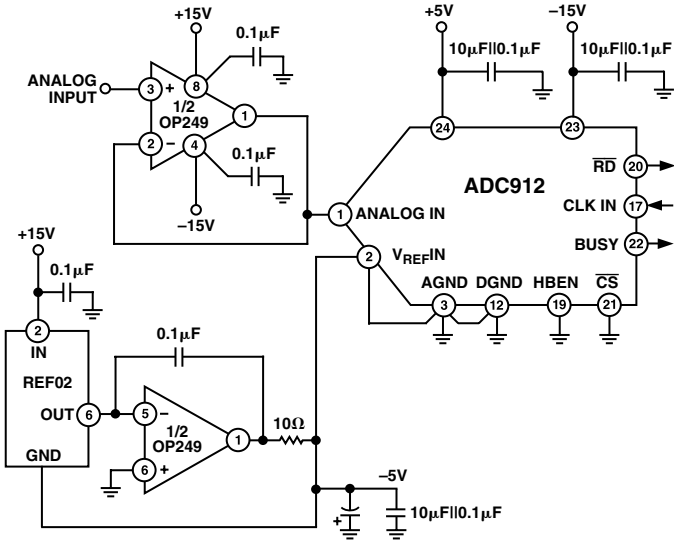

Figure 16. OP249 Dual Amplifiers Provide Both Stable -5 V Reference Input, and Buffers Input to ADC912

OP249

OP249 SPICE MACRO-MODEL

Figures 18 and Table I show the node and net list for a SPICE macromodel of the OP249. The model is a simplified version of the actual device and simulates important dc parameters such as V_{OS} , I_{OS} , I_B , A_{VO} , CMR , V_O and I_{SY} . AC parameters such as slew rate, gain and phase response and CMR change with frequency are also simulated by the model.

The model uses typical parameters for the OP249. The poles and zeros in the model were determined from the actual open and closed-loop gain and phase response of the OP249. In this way, the model presents an accurate ac representation of the actual device. The model assumes an ambient temperature of 25°C.

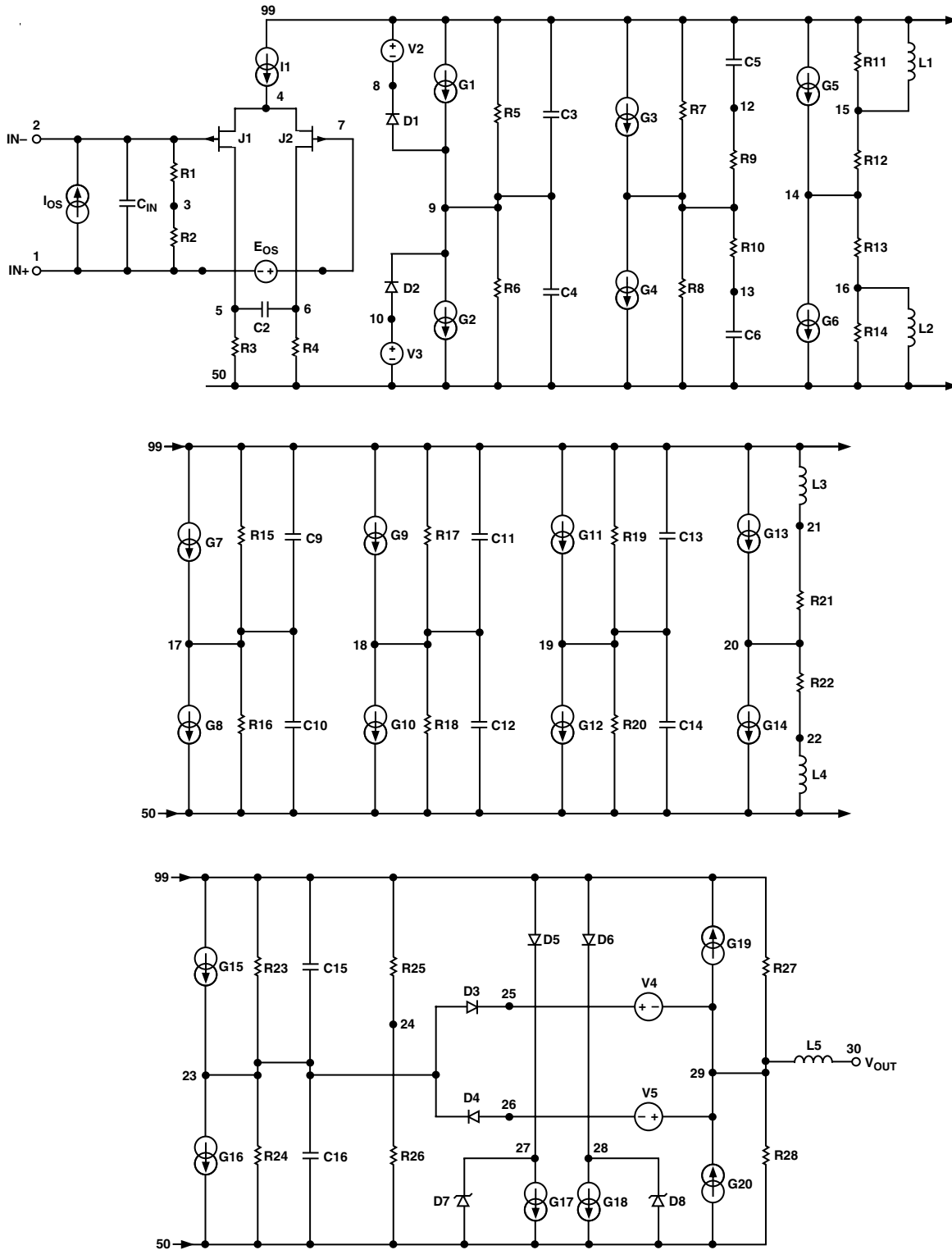

Figure 18. Macro-Model

Table I. SPICE Net List

OP249 MACRO-MODEL

```

* subckt OP249 1 2 30 99 50
*
INPUT STAGE & POLE AT 100MHz
*
r1 2 3 5E11
r2 1 3 5E11
r3 5 50 652.3
r4 6 50 652.3
cin 1 2 5E-12
c2 5 6 1.22E-12
i1 99 4 1E-3
ios 1 2 3.1E-12
eos 7 1 poly(1) 20 24 150E-6 1
j1 5 2 4 jx
j2 6 7 4 jx
*
* SECOND STAGE & POLE AT 12.2Hz
*
r5 9 99 326.1E6
r6 9 50 326.1E6
c3 9 99 40E-12
c4 9 50 40E-12
g1 99 9 poly(1) 5 6 4.25E-3 1.533E-3
g2 9 50 poly(1) 6 5 4.25E-3 1.533E-3
v2 99 8 2.9
v3 10 50 2.9
d1 9 8 dx
d2 10 9 dx
*
* POLE-ZERO PAIR AT 2MHz/4.0MHz
*
r7 11 99 1E6
r8 11 50 1E6
r9 11 12 1E6
r10 11 13 1E6
c5 12 99 37.79E-15
c6 13 50 37.79E-15
g3 99 11 9 24 1E-6
g4 11 50 24 9 1E-6
*
* ZERO-POLE PAIR AT 4MHz/8MHz
*
r11 99 15 1E6
r12 14 15 1E6
r13 14 16 1E6
r14 50 16 1E6
I1 99 15 19.89E-3
I2 50 16 19.89E-3
g5 99 14 11 24 1E-6
g6 14 50 24 11 1E-6
*
* POLE AT 20MHz
*
r15 17 99 1E6
r16 17 50 1E6
c9 17 99 7.96E-15
c10 17 50 7.96E-15
g7 99 17 14 24 1E-6
g8 17 50 24 14 1E-6
*
* POLE AT 50MHz
*
r17 18 99 1E6
r18 18 50 1E6
c11 18 99 3.18E-15
c12 18 50 3.18E-15
g9 99 18 17 24 1E-6
g10 18 50 24 17 1E-6

```

```

*
* POLE AT 50MHz
*
r19 19 99 1E6
r20 19 50 1E6
c13 19 99 3.18E-15
c14 19 50 3.18E-15
g11 99 19 18 24 1E-6
g12 19 50 24 18 1E-6
*
* COMMON-MODE GAIN NETWORK WITH ZERO AT 60kHz
*
r21 20 21 1E6
r22 20 22 1E6
I3 21 99 2.65
I4 22 50 2.65
g13 99 20 3 24 1.78E-11
g14 20 50 24 3 1.78E-11
*
* POLE AT 50MHz
*
r23 23 99 1E6
r24 23 50 1E6
c15 23 99 3.18E-15
c16 23 50 3.18E-15
g15 99 23 19 24 1E-6
g16 23 50 24 19 1E-6
*
* OUTPUT STAGE
*
r25 24 99 135E3
r26 24 50 135E3
r27 29 99 70
r28 29 50 70
I5 29 30 4E-7
g17 27 50 23 29 14.3E-3
g18 28 50 29 23 14.3E-3
g19 29 99 99 23 14.3E-3
g20 50 29 23 50 14.3E-3
v4 25 29 .4
v5 29 26 .4
d3 23 25 dx
d4 26 23 dx
d5 99 27 dx
d6 99 28 dx
d7 50 27 dy
d8 50 28 dy
*
MODELS USED
*
• model jx PJF(BETA=1.175E-3 VTO=-2.000 IS=21E-12)
• model dx D(IS=1E-15)
• model dy D(IS=1E-15 BV=50)
• ends OP249

```

* PSpice is a registered trademark of MicroSim Corporation.
** HSPICE is a tradename of Meta-Software, Inc.

OP249

OUTLINE DIMENSIONS

Dimensions shown in inches and (mm).

**8-Lead Plastic DIP
(N-8)**

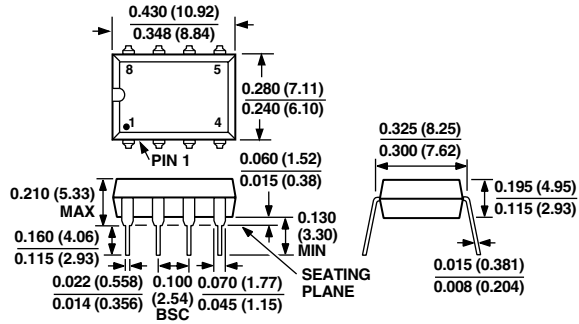

**8-Lead Narrow Body (SOIC)
(SO-8)**

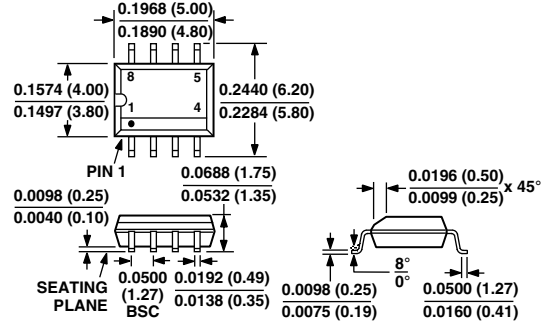

**8-Lead Cerdip
(Q-8)**

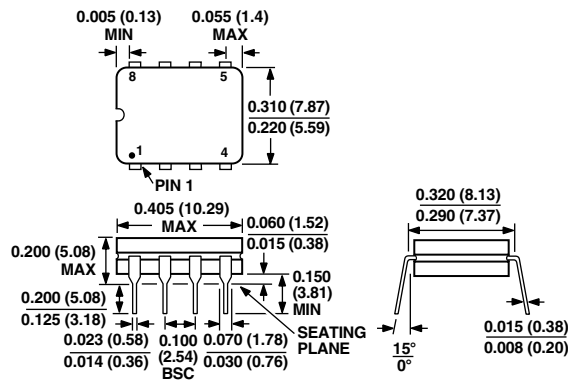

Revision History

Location	Page
9/01—Data Sheet changed from REV. D to REV. E.	
Edits to FEATURES	1
Edits to PIN CONNECTIONS	1
Edits to ELECTRICAL CHARACTERISTICS	2, 3
Edits to ABSOLUTE MAXIMUM RATINGS	4
Edits to PACKAGE TYPE	4
Edits to ORDERING GUIDE	4
Deleted WAFER TEST LIMITS	5
Deleted DICE CHARACTERISTICS	5
Edits to TYPICAL PERFORMANCE CHARACTERISTICS	8
Edits to Macro-Model Figure	15
Edits to OUTLINE DIMENSIONS	17