

# 622/632-Series

Small-Sized Rocker Switches

[PRODUCT WEBPAGE](#)

*request sample, configure part*



A high powered offering packed into a small-sized envelope, the 622/632-Series is a staple of numerous markets. With its silver-alloy butt contacts, the 622/632 will handle inrush spikes up to 100 amps and steady state current to 12A 125VAC. The lighted 632-Series features a multitude of illumination circuit options available with LED, incandescent and neon style lamps.

**1-2** Poles    **8-12** Amps    **125-250** VAC    **6-24** VDC

## Typical Applications

- Appliances
- Commercial Food
- Transportation
- General Purpose

# Tech Specs

## Dielectric Strength

UL/CSA: 1000V - live to dead metal parts & opposite polarity

## Electrical Life

50,000 cycles

## Operating Temperature

32°F to 185°F (0°C to 85°C)

# Ordering Scheme

Sample Part Number **632121 - 1 B - K N**

Selection 1 2 3 4 5

### 1. SERIES

**8A 250VAC; 12A 125VAC; 1/2 HP 125-250VAC  
622-SERIES NON-ILLUMINATED ROCKER**

ON-none-OFF (Single Pole)  
ON-none-OFF (Double Pole)

**632-SERIES ILLUMINATED ROCKER**

ON-none-OFF (Single Pole, dependent lamp) schematic 1  
ON-none-OFF (Single Pole, independent lamp) schematic 3  
ON-none-OFF (Single Pole, independent lamp unballasted) schematic 5  
ON-none-OFF (Double Pole, dependent lamp with 5 terms.) schematic 2  
ON-none-OFF (Double Pole, dependent lamp with 4 terms.) schematic 4

Solder Lugs	.187 Tabs
622121	622122
622221	622222
632121	632122
632321	632322
632521	632522
632221	632222
632421	632422

### 2. ACTUATOR COLOR

**622 (non illuminated)**

B Black  
W White

**632 (illuminated)**

1 Clear Amber  
2 Clear Red  
3 Clear Blue<sup>2</sup>  
4 Clear Green  
5 Clear

### 4. LAMP VOLTAGE / STYLE

N 622 (non illuminated)  
1 unballasted LED  
2 6V LED  
3 12V LED  
4 24V LED

A 6V incandescent  
C 12V incandescent  
E 18V incandescent  
H 24V incandescent  
J 125V neon  
K 250V neon

### 3. BASE COLOR

B Black

W White

### 5. ROCKER LEGEND

N NO Legend  
A OFF-ON vertical  
B OFF-ON horizontal  
D I-O horizontal  
E I-O vertical  
F O on rocker radius

#### Notes:

- For all incandescent or LED lamps specify 5 in 5th digit of part number.  
Example 632151-1B-CN
- Available with incandescent lamps only.
- Additional colors available. Consult factory for details.

[Configure Complete Part Number >](#)

[Browse Standard Parts >](#)

# Dimensional Specs

inches [millimeters]

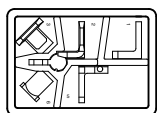
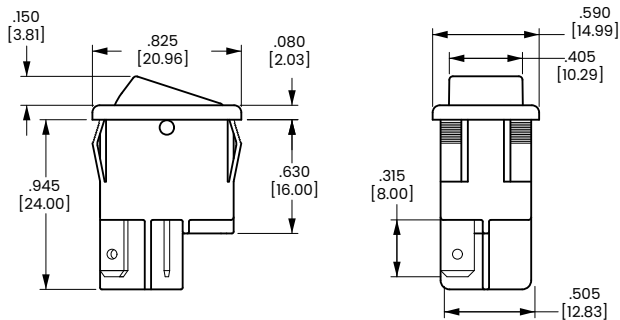

BOTTOM VIEW OF TERMINAL ARRANGEMENT

632 SCHEMATIC

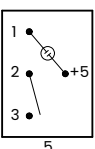
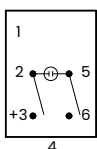
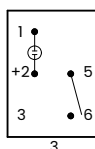
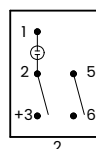
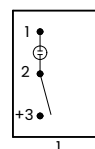

UNBALLASTED

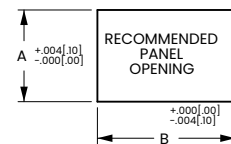
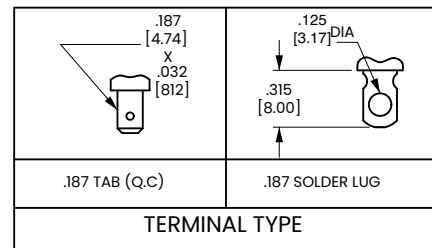

PANEL THICKNESS	A	B
.030[.76]-.050[1.27]	.508[12.90]	.756[19.20]
.050[1.27]-.078[1.98]	.508[12.90]	.764[19.40]
.078[1.98]-.125[3.17]	.508[12.90]	.780[19.81]

## Authorized Sales Representatives and Distributors

Click on a region of the map below to find your local representatives and distributors or visit [www.carlingtech.com/findarep](http://www.carlingtech.com/findarep).



## About Carling

Founded in 1920, Carling Technologies is a leading manufacturer of electrical and electronic switches and assemblies, circuit breakers, electronic controls, power distribution units, and multiplexed power distribution systems. With six ISO9001 and IATF16949 registered manufacturing facilities and technical sales offices worldwide, Carling Technologies Sales, Service and Engineering teams do much more than manufacture electrical components, they engineer powerful solutions! To learn more about Carling please visit [www.carlingtech.com/company-profile](http://www.carlingtech.com/company-profile).

To view all of Carling's environmental, quality, health & safety certifications please visit [www.carlingtech.com/environmental-certifications](http://www.carlingtech.com/environmental-certifications).

© Carling Technologies, Inc.

3. Carling is a registered trademark of Carling Technologies, Inc. in the U.S. and other countries.

# Mouser Electronics

Authorized Distributor

Click to View Pricing, Inventory, Delivery & Lifecycle Information:

## Carling Technologies:

[632122-2B-JA](#) [632152-5B-CN](#) [632152-2B-3N](#) [632152-2B-3E](#) [622122-BB-NN](#) [632122-4B-JN](#) [632151-4B-3N](#)  
[632122-2B-JN](#) [632152-3B-CN](#) [632152-4B-CN](#) [632152-1B-3E](#) [632152-4B-3E](#) [632452-4B-4E](#) [632152-1B-3N](#) [632152-2B-4N](#) [632152-2B-CN](#) [632152-2B-HN](#) [632152-4B-3N](#) [632152-4B-4N](#) [622122-BB-NE](#) [622221-BB-NA](#) [622222-BB-ND](#) [622222-BB-NE](#) [632122-4B-JA](#) [632422-2B-KE](#) [632422-4B-KE](#) [632222-2B-JE](#) [632452-1B-4E](#) [632122-5B-JA](#)  
[632152-1B-CN](#) [632252-2B-CN](#) [632552-2B-1N](#) [632322-2B-JN](#) [632422-4B-KD](#) [632252-1B-CN](#) [622221-BB-NN](#)  
[632251-1B-CN](#) [632351-1B-CN](#) [632252-2B-3N](#) [632321-1B-JN](#) [632422-4B-JE](#) [622222-BB-NN](#) [632222-2B-KN](#)  
[632221-2B-JE](#) [632422-2B-JE](#) [632552-2B-4N](#) [632351-2B-CN](#) [622121-BB-NA](#) [622222-WW-NE](#) [622221-BB-NE](#)  
[622222-BB-NA](#) [622221-BB-NB](#) [632252-1B-CA](#) [632422-2B-JN](#) [632352-2B-4N](#) [632152-2B-CA](#) [632151-1B-CN](#)  
[632222-4B-JE](#) [622221-WW-NE](#) [632322-2B-KN](#) [632222-2B-JN](#) [622122-BB-NA](#) [632152-1B-CA](#) [632352-2B-4E](#)  
[622121-BB-NN](#) [632452-2B-CN](#) [632252-3B-CN](#) [632-36306-002](#) [622-121BBND](#) [622122-BB-ND](#)