

Datasheet

Daylight-Visible, General-Purpose Indicators for Indoor or Outdoor Use

To view or download the latest technical information about this product, including specifications, dimensions, accessories, and wiring, see www.bannerengineering.com.

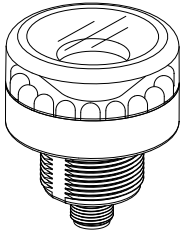

- Intense levels of light output for areas with high ambient light - even outdoors
- Viewable around entire perimeter; some models also emit light from top
- 1- or 2-, or 3-color models available
- Rugged, sealed thermoplastic housing rated for IEC IP67 and IP69K per DIN 40050-9
- Bright, even light
- 12 V dc to 30 V dc or 85 V ac to 130 V ac (75 V dc to 120 V dc) or 100 V ac to 250 V ac (90 V dc to 240 V dc) operation, depending on model
- 12 V dc operation useful for applications on mobile vehicles
- Consult factory for models with strobing capability

WARNING: Not To Be Used for Personnel Protection



Never use this device as a sensing device for personnel protection. Doing so could lead to serious injury or death. This device does not include the self-checking redundant circuitry necessary to allow its use in personnel safety applications. A sensor failure or malfunction can cause either an energized or de-energized sensor output condition.

Models

Model		LED Color(s) ¹	Input	Supply Voltage	Connection ²
Perimeter View Only	Perimeter + Top View				
K50BLXGXPQ	K50BCLXGXPQ	Green	PNP	12 V to 30 V dc	4-pin M12/Euro-style integral quick disconnect
K50BLXRX PQ	K50BCLXRX PQ	Red			
K50BLXYXPQ	K50BCLXYXPQ	Yellow			
K50BLBXPQ	K50BCLBXPQ	Blue			
K50BLWXPQ	K50BCLWXPQ	White			
K50BLGRXPQ	K50BCLGRXPQ	Green / Red			
K50BLGRYPQ	K50BCLGRYPQ	Green / Red / Yellow	PNP	12 V to 30 V dc	5-pin M12/Euro-style integral quick disconnect ³
K50BLGRYNQ	K50BCLGRYNQ	Green / Red / Yellow	NPN	12 V to 30 V dc	
K50BLGA120Q	K50BCLGA120Q	Green	AC	85 V to 130 V ac	3-pin A12/Micro-style integral quick disconnect
K50BLRA120Q	K50BCLRA120Q	Red			
K50BLYA120Q	K50BCLYA120Q	Yellow			
K50BLBA120Q	K50BCLBA120Q	Blue			
K50BLWA120Q	K50BCLWA120Q	White			
K50BLGA230Q	K50BCLGA230Q	Green	AC	100 V to 250 V ac	
K50BLRA230Q	K50BCLRA230Q	Red			
K50BLYA230Q	K50BCLYA230Q	Yellow			
K50BLBA230Q	K50BCLBA230Q	Blue			

¹ Available colors include: Green (G), Red (R), Yellow (Y), Blue (B) and White (W).

² Integral quick disconnect models are listed.

- To order the 150 mm (6 in) PVC cable model with a M12/Euro-style quick disconnect, replace the suffix "Q" with "QP" in the model number. For example, K50BLXGXPQP.
- To order the 2 m (6.5 ft) PVC cable model, omit the suffix "Q" in the model number. For example, K50BLXGXP.
- Models with a quick disconnect require a mating cordset.

³ 3-color models use a 4-pin mating cable, see wiring diagram.



Wiring Diagrams — DC Models

Table 1: 1-Color Models (PNP/NPN Selectable)

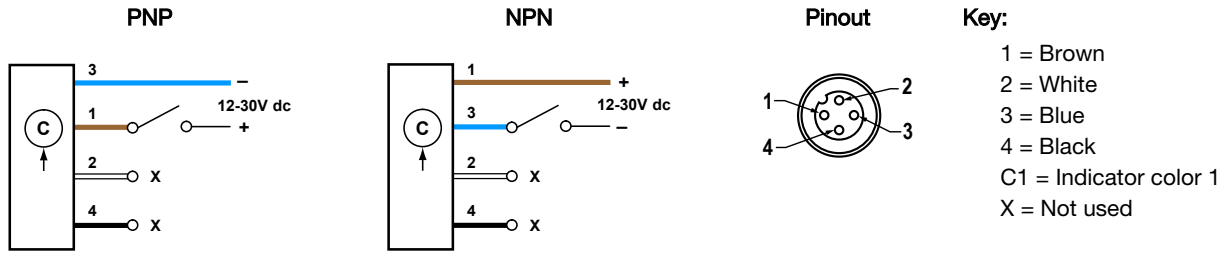

Table 2: 2-Color Models

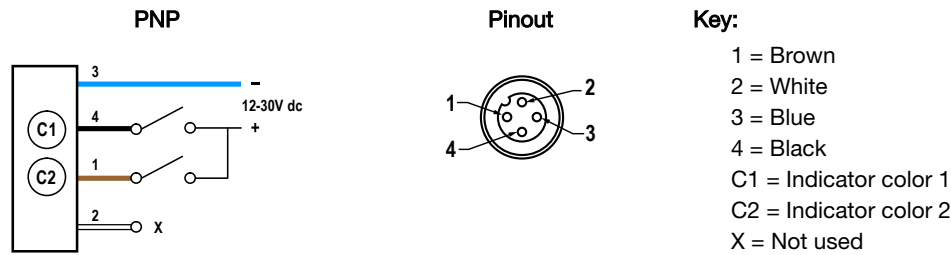
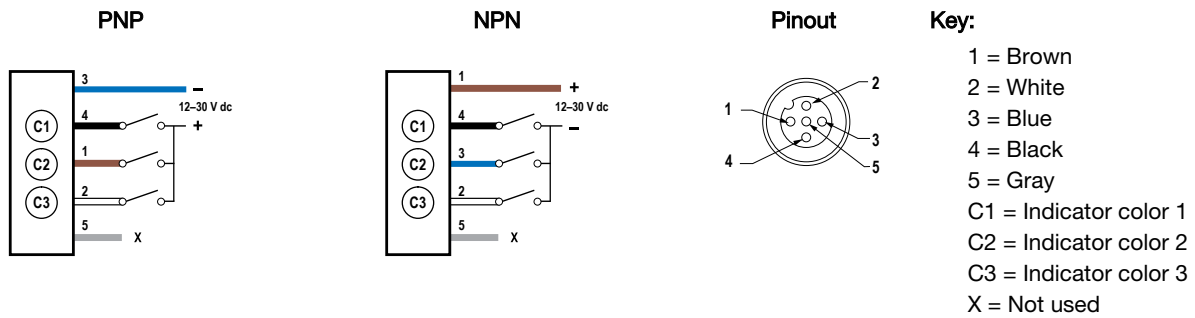
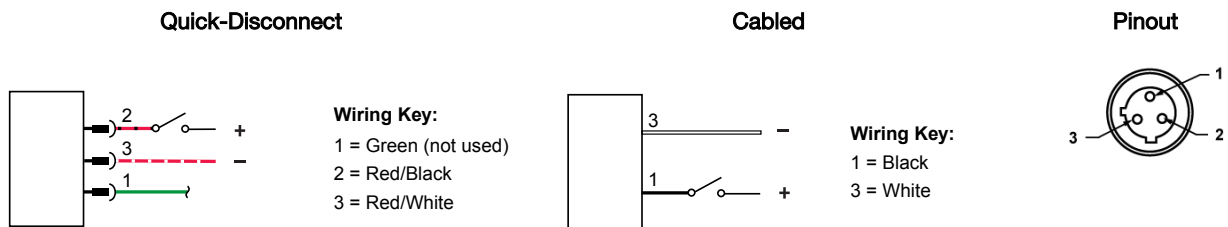

Table 3: 3-Color Models



Wiring Diagrams — AC Models



Specifications

Supply Voltage and Current - 12 V dc to 30 V dc models

- K50BL 1-color models:** 140 mA max. at 12 V dc, 70 mA max. at 30 V dc
- K50BCL 1-color models:** 160 mA max. at 12 V dc, 80 mA max. at 30 V dc
- K50BL 2-color models, per color:** 75 mA max. at 12 V dc, 40 mA max. at 30 V dc
- K50BCL 2-color models, per color:** 95 mA max. at 12 V dc, 40 mA max. at 30 V dc
- K50BL 3-color models, per color:** 85 mA max. at 12 V dc, 55 mA max. at 30 V dc
- K50BCL 3-color models, per color:** 110 mA max. at 12 V dc, 65 mA max. at 30 V dc

Supply Voltage and Current - 120 V ac models

- K50BL models:** 85 V ac to 130 V ac or 75 V dc to 120 V dc at 16 mA max. 50/60 Hz
- K50BCL models:** 85 V ac to 130 V ac or 75 V dc to 120 V dc at 60 mA max. 50/60 Hz

Supply Voltage and Current - 230 V ac models

- K50BL models:** 100 V ac to 250 V ac or 90 V dc to 240 V dc at 20 mA max. 50 Hz to 60 Hz
- K50BCL models:** 100 V ac to 250 V ac or 90 V dc to 240 V dc at 25 mA max. 50 Hz to 60 Hz

Supply Protection Circuitry

- 12 V dc to 30 V dc models:** Protected against reverse polarity and transient voltages
- 120 V ac and 230 V ac models:** Protected against transient voltages

Indicators

- LED colors are independently selected, depending on model
- For 3-color models:** only one color can be on at a time. The higher color number overrides the lower color number.

Environmental Rating

- Rated IEC IP67 and IP69K per DIN 40050-9
- NEMA/UL Type 4X, 13

Application Note

- Light emits 360° from housing sides in K50BL models and housing sides and tops in K50BCL models.

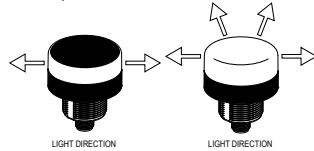

Certifications



dc models only

Construction

- Base and covers: polycarbonate

Connections

- Integral 4-pin M12/Euro-style (dc models) QD, 3-pin Micro-style (ac models) QD, or 2 m (6.5 ft) integral cable, depending on model

Operating Conditions

- 40 °C to +50 °C (-40 °F to +122 °F)
- 90% at +50 °C maximum relative humidity (non-condensing)

Vibration and Mechanical Shock

- All models meet Mil. Std. 202F requirements method 201A (vibration: 10 to 60 Hz max., double amplitude 0.06 in, maximum acceleration 10G). Also meets IEC 947-5-2; 30G 11 ms duration, half sine wave.

Indicator Power-up Response Time

DC 1, and 2- color models

- ON: 10 ms; OFF: 7 ms

DC 3-color models

- ON: 250 ms; OFF: 10 ms

AC models

- ON/OFF: 500 μs

Required Overcurrent Protection



WARNING: Electrical connections must be made by qualified personnel in accordance with local and national electrical codes and regulations.

- Overcurrent protection is required to be provided by end product application per the supplied table.
- Overcurrent protection may be provided with external fusing or via Current Limiting, Class 2 Power Supply.
- Supply wiring leads < 24 AWG shall not be spliced.
- For additional product support, go to www.bannerengineering.com.

Supply Wiring (AWG)	Required Overcurrent Protection (Amps)
20	5.0
22	3.0
24	2.0
26	1.0
28	0.8
30	0.5

Dimensions

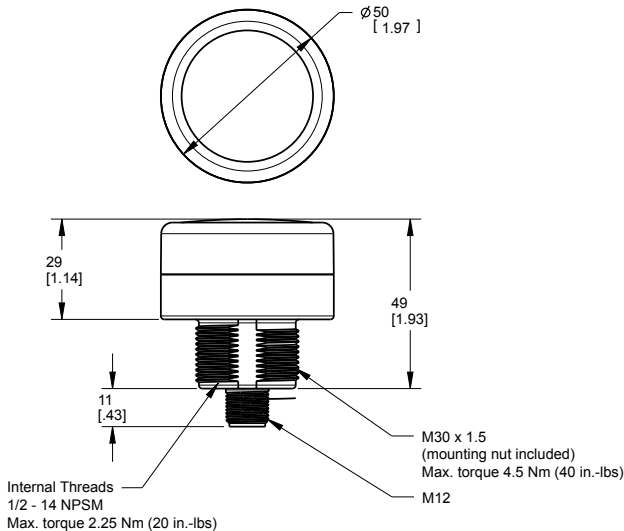

Accessories

Cordsets

4-Pin Threaded M12/Euro-Style Cordsets—Single Ended				
Model	Length	Style	Dimensions	Pinout (Female)
MQDC-406	1.83 m (6 ft)	Straight		
MQDC-415	4.57 m (15 ft)			
MQDC-430	9.14 m (30 ft)			
MQDC-450	15.2 m (50 ft)	Right-Angle		
MQDC-406RA	1.83 m (6 ft)			
MQDC-415RA	4.57 m (15 ft)			
MQDC-430RA	9.14 m (30 ft)			
MQDC-450RA	15.2 m (50 ft)			

3-Pin Micro-Style Cordsets				
Model	Length	Style	Dimensions	Pinout (Female)
MQDC-306	1.83 m (6 ft)	Straight		
MQDC-315	4.57 m (15 ft)			
MQDC-330	9.14 m (30 ft)	Right-Angle		
MQDC-306RA	1.83 m (6 ft)			
MQDC-315RA	4.57 m (15 ft)			
MQDC-330RA	9.14 m (30 ft)			

Mounting Brackets

All measurements are listed in millimeters, unless noted otherwise.

SMB30A

- Right-angle bracket with curved slot for versatile orientation
- Clearance for M6 (1/4 in) hardware
- Mounting hole for 30 mm sensor
- 12-ga. stainless steel

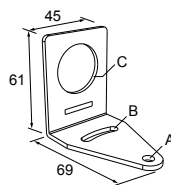

Hole center spacing: A to B=40

Hole size: A=ø 6.3, B= 27.1 x 6.3, C=ø 30.5

SMB30FA

- Swivel bracket with tilt and pan movement for precise adjustment
- Mounting hole for 30 mm sensor
- 12-ga. 304 stainless steel
- Easy sensor mounting to extrude rail T-slot
- Metric and inch size bolt available

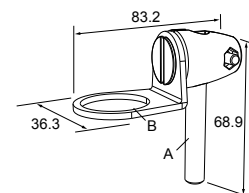

Bolt thread: SMB30FA, A= 3/8 - 16 x 2 in; SMB30FAM10, A= M10 - 1.5 x 50

Hole size: B= ø 30.1

SMB30MM

- 12-ga. stainless steel bracket with curved mounting slots for versatile orientation
- Clearance for M6 (¼ in) hardware
- Mounting hole for 30 mm sensor

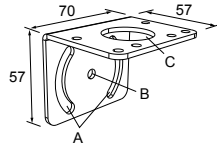

Hole center spacing: A = 51, A to B = 25.4
Hole size: A = 42.6 x 7, B = ø 6.4, C = ø 30.1

SMB30SC

- Swivel bracket with 30 mm mounting hole for sensor
- Black reinforced thermoplastic polyester
- Stainless steel mounting and swivel locking hardware included

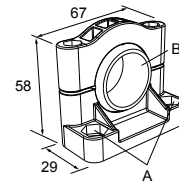

Hole center spacing: A=ø 50.8
Hole size: A=ø 7.0, B=ø 30.0

LMBE12RA35

- Direct mounting of stand-off pipe, with common bracket type
- Zinc-plated steel
- 1/2-14 NPSM nut
- Mounting distance from the wall to the center of the 1/2-14 NPSM nut is 35 mm

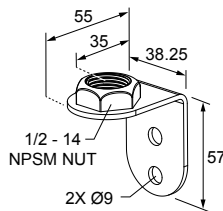

Hole center spacing: 20.0

LMBE12RA45

- Direct mounting of stand-off pipe, with common bracket type
- Zinc-plated steel
- 1/2-14 NPSM nut
- Mounting distance from the wall to the center of the 1/2-14 NPSM nut is 45 mm

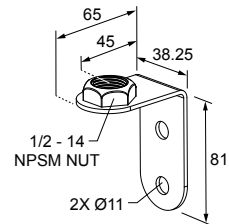

Hole center spacing: 35.0

Elevated Mount System

Model			Features	Components
SA-M30E12 - Black Acetal			<ul style="list-style-type: none"> • Streamlined black acetal stand-off pipe adapter/cover • Connects between 30 mm light base and ½ in. NPSM/DN15 pipe • Mounting hardware included 	
Polished 304 Stainless Steel	Black Anodized Aluminum	Clear Anodized Aluminum	<ul style="list-style-type: none"> • Elevated-use stand-off pipe (½ in. NPSM/DN15) • Polished 304 stainless steel, black anodized aluminum, or clear anodized aluminum surface • ½ in. NPT thread at both ends • Compatible with most industrial environments 	
SOP-E12-150SS 150 mm (6 in) long	SOP-E12-150A 150 mm (6 in) long	SOP-E12-150AC 150 mm (6 in) long		
SOP-E12-300SS 300 mm (12 in) long	SOP-E12-300A 300 mm (12 in) long	SOP-E12-300AC 300 mm (12 in) long		
SOP-E12-900SS 900 mm (36 in) long	SOP-E12-900A 900 mm (36 in) long	SOP-E12-900AC 900 mm (36 in) long		
SA-E12M30 - Black Acetal			<ul style="list-style-type: none"> • Streamlined black acetal mounting base adapter/cover • Connects between ½ in. NPSM/DN15 pipe and 30 mm (1-3/16 in) drilled hole • Mounting hardware included 	

Banner Engineering Corp. Limited Warranty

Banner Engineering Corp. warrants its products to be free from defects in material and workmanship for one year following the date of shipment. Banner Engineering Corp. will repair or replace, free of charge, any product of its manufacture which, at the time it is returned to the factory, is found to have been defective during the warranty period. This warranty does not cover damage or liability for misuse, abuse, or the improper application or installation of the Banner product.

THIS LIMITED WARRANTY IS EXCLUSIVE AND IN LIEU OF ALL OTHER WARRANTIES WHETHER EXPRESS OR IMPLIED (INCLUDING, WITHOUT LIMITATION, ANY WARRANTY OF MERCHANTABILITY OR FITNESS FOR A PARTICULAR PURPOSE), AND WHETHER ARISING UNDER COURSE OF PERFORMANCE, COURSE OF DEALING OR TRADE USAGE.

This Warranty is exclusive and limited to repair or, at the discretion of Banner Engineering Corp., replacement. **IN NO EVENT SHALL BANNER ENGINEERING CORP. BE LIABLE TO BUYER OR ANY OTHER PERSON OR ENTITY FOR ANY EXTRA COSTS, EXPENSES, LOSSES, LOSS OF PROFITS, OR ANY INCIDENTAL, CONSEQUENTIAL OR SPECIAL DAMAGES RESULTING FROM ANY PRODUCT DEFECT OR FROM THE USE OR INABILITY TO USE THE PRODUCT, WHETHER ARISING IN CONTRACT OR WARRANTY, STATUTE, TORT, STRICT LIABILITY, NEGLIGENCE, OR OTHERWISE.**

Banner Engineering Corp. reserves the right to change, modify or improve the design of the product without assuming any obligations or liabilities relating to any product previously manufactured by Banner Engineering Corp. Any misuse, abuse, or improper application or installation of this product or use of the product for personal protection applications when the product is identified as not intended for such purposes will void the product warranty. Any modifications to this product without prior express approval by Banner Engineering Corp will void the product warranties. All specifications published in this document are subject to change; Banner reserves the right to modify product specifications or update documentation at any time. Specifications and product information in English supersede that which is provided in any other language. For the most recent version of any documentation, refer to: www.bannerengineering.com.

For patent information, see www.bannerengineering.com/patents.

FCC Part 15 and CAN ICES-3 (B)/NMB-3(B)

This device complies with part 15 of the FCC Rules and CAN ICES-3 (B)/NMB-3(B). Operation is subject to the following two conditions:

1. This device may not cause harmful interference, and
2. This device must accept any interference received, including interference that may cause undesired operation.

This equipment has been tested and found to comply with the limits for a Class B digital device, pursuant to part 15 of the FCC Rules and CAN ICES-3 (B)/NMB-3(B). These limits are designed to provide reasonable protection against harmful interference in a residential installation. This equipment generates, uses and can radiate radio frequency energy and, if not installed and used in accordance with the instructions, may cause harmful interference to radio communications. However, there is no guarantee that interference will not occur in a particular installation. If this equipment does cause harmful interference to radio or television reception, which can be determined by turning the equipment off and on, the user is encouraged to try to correct the interference by one or more of the following measures:

- Reorient or relocate the receiving antenna.
- Increase the separation between the equipment and receiver.
- Connect the equipment into an outlet on a circuit different from that to which the receiver is connected.
- Consult the manufacturer.

Mouser Electronics

Authorized Distributor

Click to View Pricing, Inventory, Delivery & Lifecycle Information:

[Banner Engineering:](#)

[K50BCLRA230Q](#) [K50BCLXGXP](#) [K50BLGRXPQ](#) [K50BLGRYPQ](#) [K50BCLBA120](#) [K50BCLBA120Q](#) [K50BCLBA230Q](#)
[K50BCLBRXPQ](#) [K50BCLBXXPQ](#) [K50BCLGA120](#) [K50BCLGA120Q](#) [K50BCLGA230](#) [K50BCLGBWPQ](#)
[K50BCLGBXPQ](#) [K50BCLGRBP](#) [K50BCLGRWPQ](#) [K50BCLGRXP](#) [K50BCLGRXPQ](#) [K50BCLGRYNQ](#) [K50BCLGRYP](#)
[K50BCLGRYPQ](#) [K50BCLGRYPQP](#) [K50BCLGXXPQ](#) [K50BCLGYRPQ](#) [K50BCLGYXPQ](#) [K50BCLRA120](#)
[K50BCLRA120Q](#) [K50BCLRA230](#) [K50BCLRXXPQ](#) [K50BCLRXXPQP](#) [K50BCLWA120](#) [K50BCLWA230](#)
[K50BCLWGXPQ](#) [K50BCLWXXPQ](#) [K50BCLXBP](#) [K50BCLXBPQ](#) [K50BCLXGXPQ](#) [K50BCLXRP](#) [K50BCLXRPQ](#)
[K50BCLXRPQP](#) [K50BCLXWP](#) [K50BCLXWPQ](#) [K50BCLXYXP](#) [K50BCLXYXPQ](#) [K50BCLXYXPQP](#)
[K50BCLYA120](#) [K50BCLYA120Q](#) [K50BCLYA230](#) [K50BCLYA230Q](#) [K50BCLYRXPQ](#) [K50BCLYWXPQ](#)
[K50BCLYXXPQ](#) [K50BLBA120](#) [K50BLBYXNQ](#) [K50BLGBWPQ](#) [K50BLGRXP](#) [K50BLGRYNQ](#) [K50BLGRYP](#)
[K50BLGRYPQP](#) [K50BLRA120](#) [K50BLRA120Q](#) [K50BLRA230](#) [K50BLWA120Q](#) [K50BLXBP](#) [K50BLXBP W/10](#)
[K50BLXBPQ](#) [K50BLXGXP](#) [K50BLXGXPQ](#) [K50BLXRP](#) [K50BLXRPQ](#) [K50BLXYXP](#) [K50BLYA120](#)
[K50BLYA120Q](#) [K50BLYA230](#) [K50BLYRXPQ](#) [K50BLYXXPQ](#)