



Parameter	Rating	Units
Open Circuit Voltage	12.2	V
Short Circuit Current	9.1	μA

Features

- Dual Independent, Floating Outputs for Parallel, Series, or Isolated Configuration
- 24.4V Open Circuit Voltage in Series Configuration
- 18.2 μA Short Circuit Current in Parallel Configuration
- 5mA Control Current
- Integrated Turn-Off Circuitry
- High Input to Output Isolation: 3750V_{rms}
- Replacement of Discrete Components
- No EMI/RFI Generation
- Solid State Reliability
- Machine Insertable, Wave Solderable
- Surface Mount and Tape & Reel Version Available

Applications

- MOSFET Driver
- Programmable Control
- Process Control
- Instrumentation
- Telecommunications
- Solid State Relays
- Isolated Switching
- Floating Power Supplies

Description

The FDA217 is a dual photovoltaic MOSFET driver. Each independent driver consists of an LED that is optically coupled to a photodiode array.

The driver output is controlled by means of the highly effective GaAlAs infrared LED at the input. When the input current is applied to the LED, the light emitted activates the photodiode array, and generates the voltage at the output.

The photodiode array is capable of generating a floating power source with voltage and current sufficient to drive high-power MOSFET transistors. Each photodiode array contains an integrated turn-off circuit that discharges the external MOSFET gate when LED current is removed. This eliminates the need to use external components to facilitate the discharge. The optically coupled technology provides 3750V_{rms} of input to output isolation.

The FDA217 is well suited for use in discrete solid state relay designs and in other isolated switching applications.

Approvals

- EN/IEC 60950 Certified Component:
TUV Certificate: B 12 11 82667 002

Ordering Information

Part #	Description
FDA217	8-Lead DIP (50/tube)
FDA217S	8-Lead Surface Mount (50/tube)
FDA217STR	8-Lead Surface Mount (1000/reel)

Pin Configuration

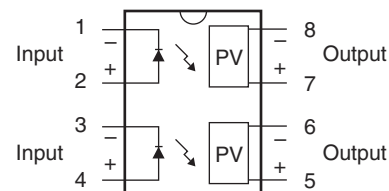

Absolute Maximum Ratings @ 25°C

Parameter	Ratings	Units
Reverse Input Voltage	5	V
Input Control Current	50	mA
Peak (10ms)	1	A
Input Power Dissipation ¹	140	mW
Total Power Dissipation ²	500	mW
ESD Rating, Human Body Model	8	kV
Isolation Voltage, Input to Output	3750	V _{rms}
Operational Temperature	-40 to +85	°C
Storage Temperature	-40 to +125	°C

Absolute Maximum Ratings are stress ratings. Stresses in excess of these ratings can cause permanent damage to the device. Functional operation of the device at conditions beyond those indicated in the operational sections of this data sheet is not implied.

¹ Derate linearly 1.33 mW / °C

² Derate linearly 6.67 mW / °C

Electrical Characteristics @ 25°C

Parameter	Conditions	Symbol	Min	Typ	Max	Units
Output Characteristics						
Open Circuit Voltage	I _F =5mA	V _{OC}	10.5	11.75	15.3	V
	I _F =10mA		10.5	12.2	15.3	
Short Circuit Current	I _F =5mA	I _{SC}	2.5	4.5	-	µA
	I _F =10mA		5	9.1		
	I _F =15mA		7.5	13.5		
	I _F =20mA		10	18.5		
	I _F =30mA		15	27		
Switching Speeds	I _F =5mA, V _{LOAD} =5V, C _{LOAD} =200pF	t _{on}	-	-	2	ms
		t _{off}	-	-	0.5	
Offstate Resistance	V _L =1V	R	100	770	3300	Ω
Input Characteristics						
LED Current to Activate	I _{SC} =2.5µA	I _F	-	3.8	5	mA
Input Voltage Drop	I _F =5mA	V _F	0.9	1.26	1.4	V
Reverse Input Current	V _R =5V	I _R	-	-	10	µA
Common Characteristics						
Capacitance, Input to Output	-	-	-	3	-	pF

Performance Data (@ 25°C Unless Otherwise Noted) *

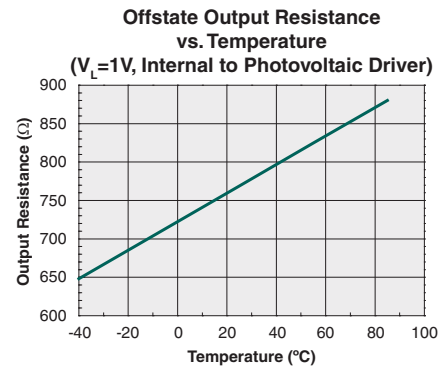
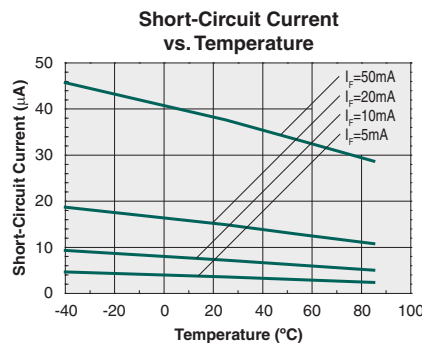
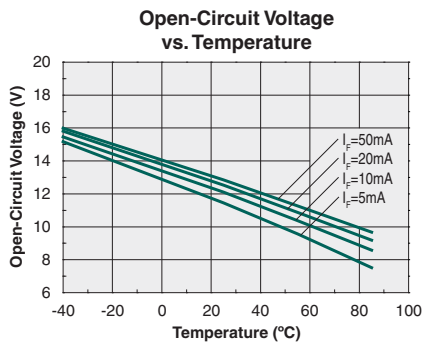
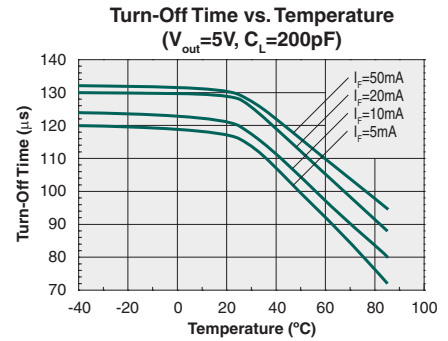
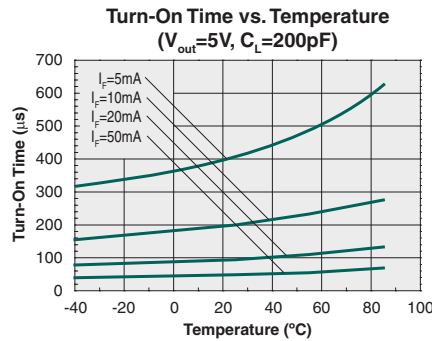
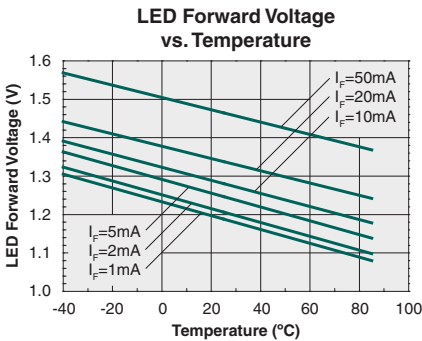
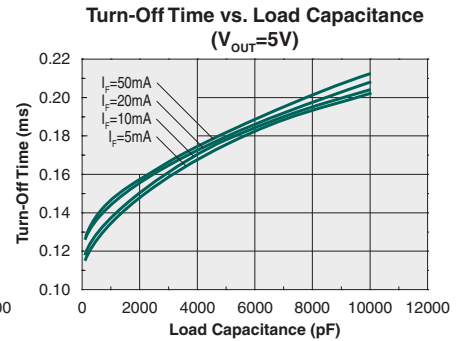
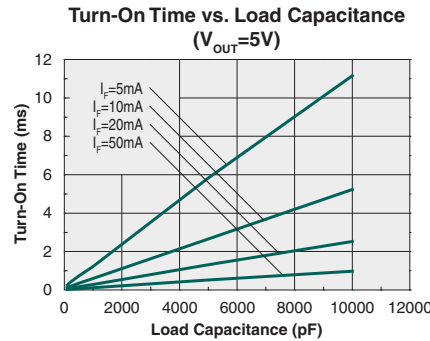
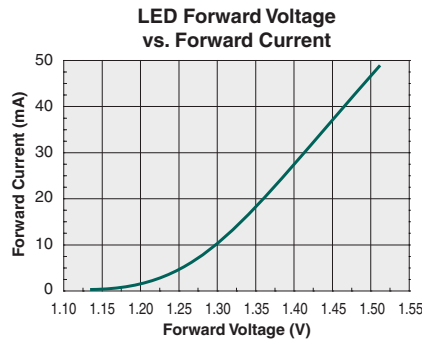
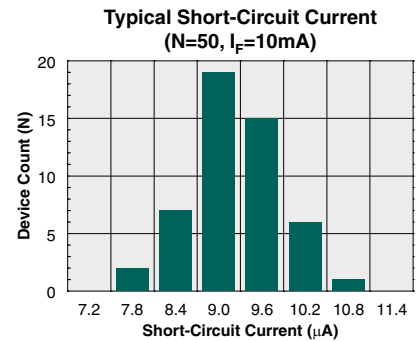
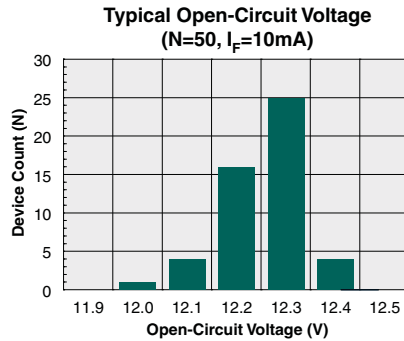
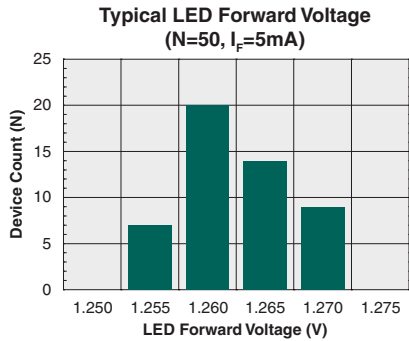

*The Performance data shown in the graphs above is typical of device performance. For guaranteed parameters not indicated in the written specifications, please contact our application department.

Manufacturing Information

Moisture Sensitivity



All plastic encapsulated semiconductor packages are susceptible to moisture ingress. IXYS Integrated Circuits Division classified all of its plastic encapsulated devices for moisture sensitivity according to the latest version of the joint industry standard, **IPC/JEDEC J-STD-020**, in force at the time of product evaluation. We test all of our products to the maximum conditions set forth in the standard, and guarantee proper operation of our devices when handled according to the limitations and information in that standard as well as to any limitations set forth in the information or standards referenced below.

Failure to adhere to the warnings or limitations as established by the listed specifications could result in reduced product performance, reduction of operable life, and/or reduction of overall reliability.

This product carries a **Moisture Sensitivity Level (MSL) rating** as shown below, and should be handled according to the requirements of the latest version of the joint industry standard **IPC/JEDEC J-STD-033**.

Device	Moisture Sensitivity Level (MSL) Rating
FDA217 / FDA217S	MSL 1

ESD Sensitivity



This product is **ESD Sensitive**, and should be handled according to the industry standard **JESD-625**.

Reflow Profile

This product has a maximum body temperature and time rating as shown below. All other guidelines of **J-STD-020** must be observed.

Device	Maximum Temperature x Time
FDA217 / FDA217S	250°C for 30 seconds

Board Wash

IXYS Integrated Circuits Division recommends the use of no-clean flux formulations. However, board washing to remove flux residue is acceptable. Since IXYS Integrated Circuits Division employs the use of silicone coating as an optical waveguide in many of its optically isolated products, the use of a short drying bake could be necessary if a wash is used after solder reflow processes. Chlorine- or Fluorine-based solvents or fluxes should not be used. Cleaning methods that employ ultrasonic energy should not be used.



Mechanical Dimensions

FDA217

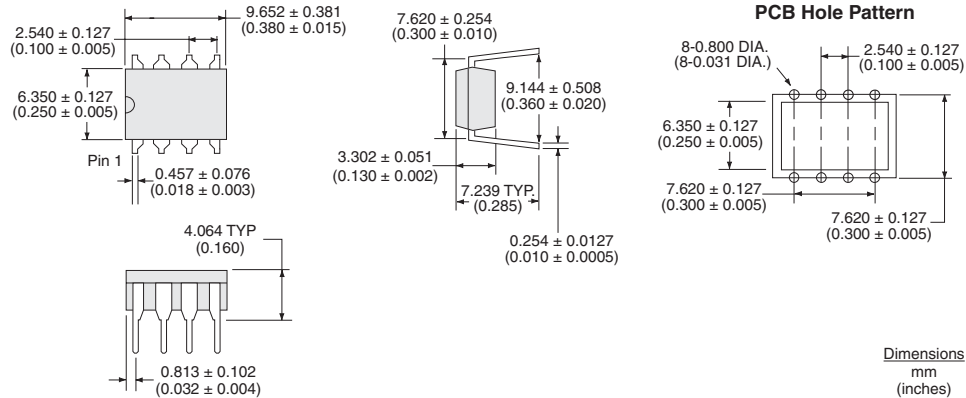

FDA217S

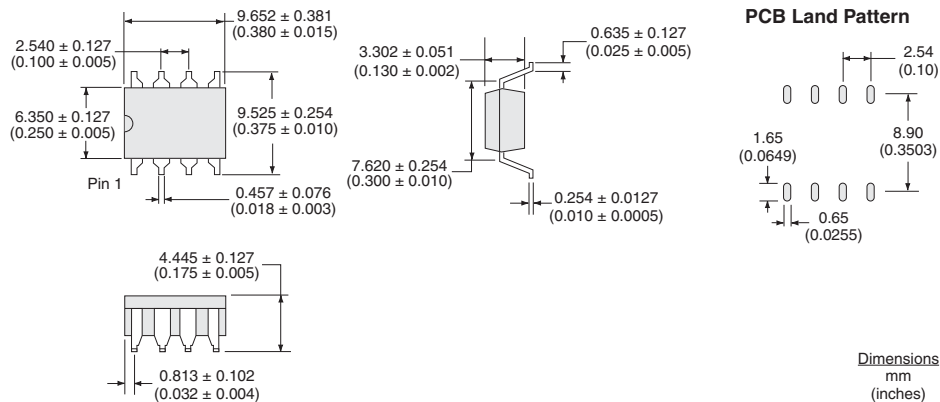

FDA217STR Tape & Reel

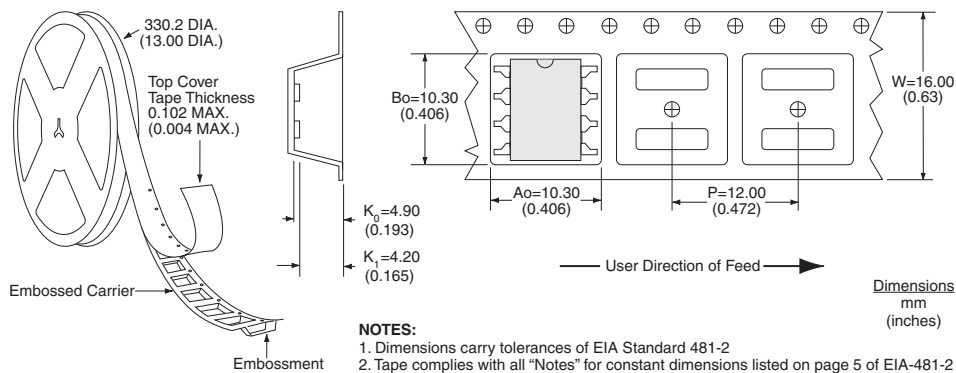

For additional information please visit our website at: www.ixysic.com

IXYS Integrated Circuits Division makes no representations or warranties with respect to the accuracy or completeness of the contents of this publication and reserves the right to make changes to specifications and product descriptions at any time without notice. Neither circuit patent licenses nor indemnity are expressed or implied. Except as set forth in IXYS Integrated Circuits Division's Standard Terms and Conditions of Sale, IXYS Integrated Circuits Division assumes no liability whatsoever, and disclaims any express or implied warranty, relating to its products including, but not limited to, the implied warranty of merchantability, fitness for a particular purpose, or infringement of any intellectual property right.

The products described in this document are not designed, intended, authorized or warranted for use as components in systems intended for surgical implant into the body, or in other applications intended to support or sustain life, or where malfunction of IXYS Integrated Circuits Division's product may result in direct physical harm, injury, or death to a person or severe property or environmental damage. IXYS Integrated Circuits Division reserves the right to discontinue or make changes to its products at any time without notice.

Mouser Electronics

Authorized Distributor

Click to View Pricing, Inventory, Delivery & Lifecycle Information:

[IXYS:](#)

[FDA217](#) [FDA217STR](#) [FDA217S](#)