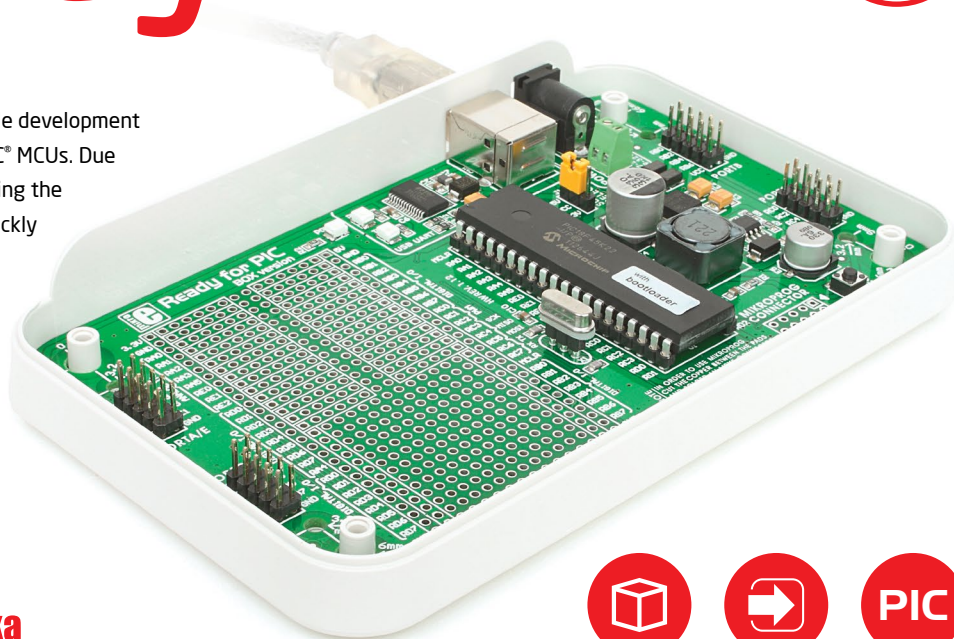


# Ready™ for PIC®

with  
**DIP40**  
socket

Best solution for fast and simple development of applications using 40-pin PIC® MCUs. Due to the special white plastic casing the Ready for PIC® board can be quickly turned into a final product.



# TO OUR VALUED CUSTOMERS

I want to express my thanks to you for being interested in our products and for having confidence in MikroElektronika.

The primary aim of our company is to design and produce high quality electronic products and to constantly improve the performance thereof in order to better suit your needs.

A handwritten signature in white ink, appearing to read 'N. Matic', is positioned on the right side of the page. The signature is fluid and cursive, with a large initial 'N' and 'M'.

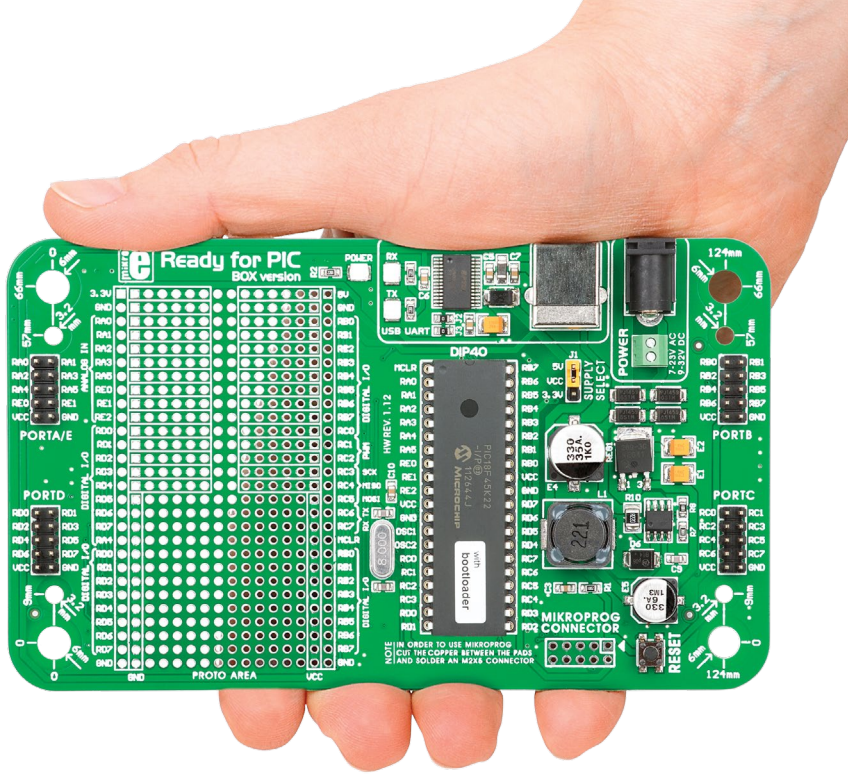
Nebojsa Matic  
General Manager

# Table of contents

Introduction	4	step 5 - Uploading .HEX file	13
Package contains	5	step 6 - Progress bar	14
Key features	6	step 7 - Finishing upload	14
1. Power supply	8	3. Programming with mikroProg™ programmer	15
2. Programming with mikroBootloader	10	4. USB-UART	18
mikroBootloader software	10	5. Prototyping area	19
Identifying device COM port	11	6. Pin headers and connection pads	20
step 1 - Choosing COM port	11	7. Reset button	22
step 2 - Establishing connection	12	8. Integrating with the casing	23
step 3 - Browsing for .HEX file	12	9. Dimensions	24
step 4 - Selecting .HEX file	13		

# Introduction

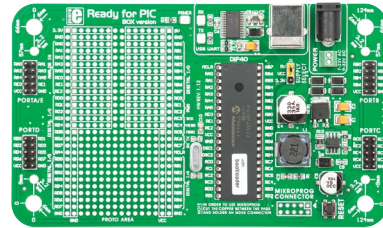
Ready for PIC® Board is the best solution for fast and simple development of various microcontroller applications. The board is equipped with the **PIC18F45K22** MCU that is placed in a DIP 40 socket and contains male headers and connection pads for all available microcontroller ports. The pins are grouped according to their functions, which is clearly indicated on the silkscreen. The MCU comes preprogrammed with mikroBootloader, but it can also be programmed with mikroProg™ programmer. The board also contains USB-UART module, prototyping area and a power supply circuit. It is specially designed to fit into the special white plastic casing so that you can turn your PIC® project into a final product.



# Package contains



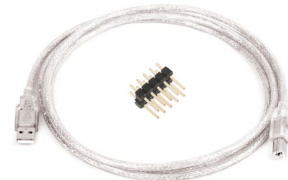
01 Damage resistant protective box



02 Ready for PIC® board



03 User's guide and schematics



04 USB cable, one 2x5 header

# Key features

## System specification



### power supply

Via AC/DC connector 7-23V AC  
or 9-32V DC



### power consumption

6.2mA in idle state  
(when on-board modules are off)



### board dimensions

141 x 84mm (5.55 x 3.3 inch)



### weight

~60g (0.13 lbs)

Power LED indicator 01

UART communication LEDs (RX.TX) 02

FTDI chip 03

USB UART connector 04

Power supply select 05

Power adapter connector 06

Power screw terminals 07

Male headers 08

Reset button 09

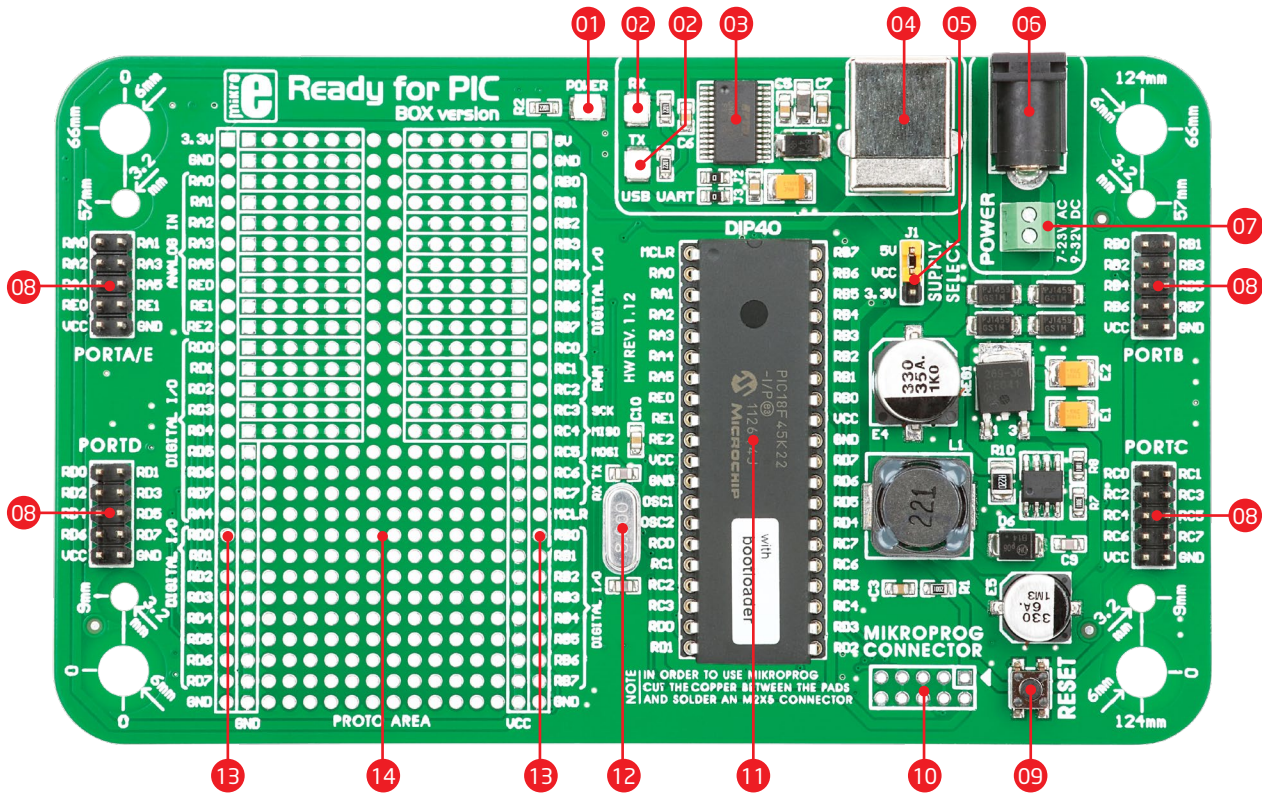
mikroProg™ connector 10

PIC18F45K22 microcontroller 11

Crystal oscillator 12

Connection pads 13

Prototyping area 14





# 1. Power supply

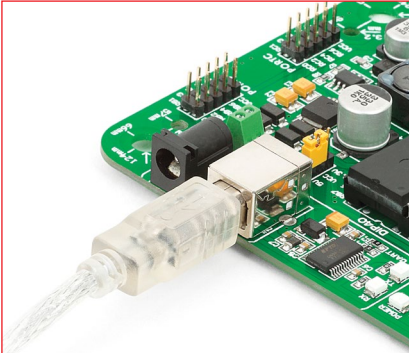


Figure 1-1:  
USB power supply

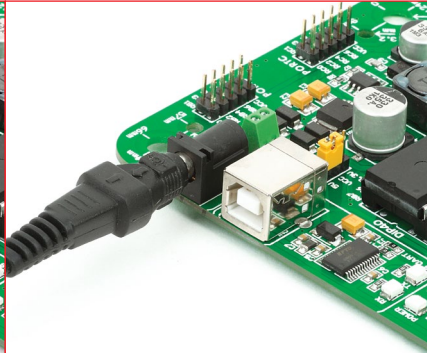


Figure 1-2:  
AC/DC adapter power supply

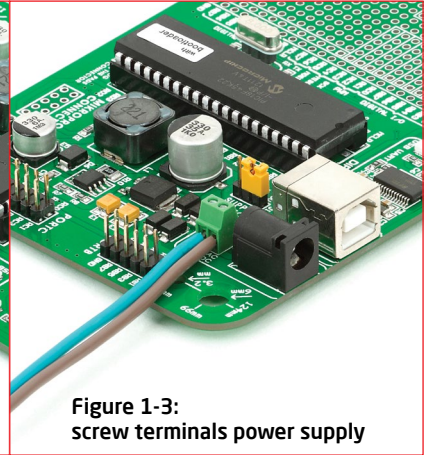


Figure 1-3:  
screw terminals power supply

Ready for PIC® board can be powered in three different ways: via USB connector (**CN1**), via adapter connector using external adapters (**CN2**) or via additional screw terminals (**CN46**). The USB connection can provide up to 500mA of current which is more than enough for the operation of every on-board module and the microcontroller as well. If you decide to use external power supply, voltage values must be within **7-23V AC** or **9-32V DC** range. **Power LED ON (GREEN)** indicates the presence of a power supply. Use only one of the suggested methods for powering the board. If you use an MCU with a 5V power supply place jumper J1 in the 5V position. Otherwise, it should be placed in the 3.3V position.



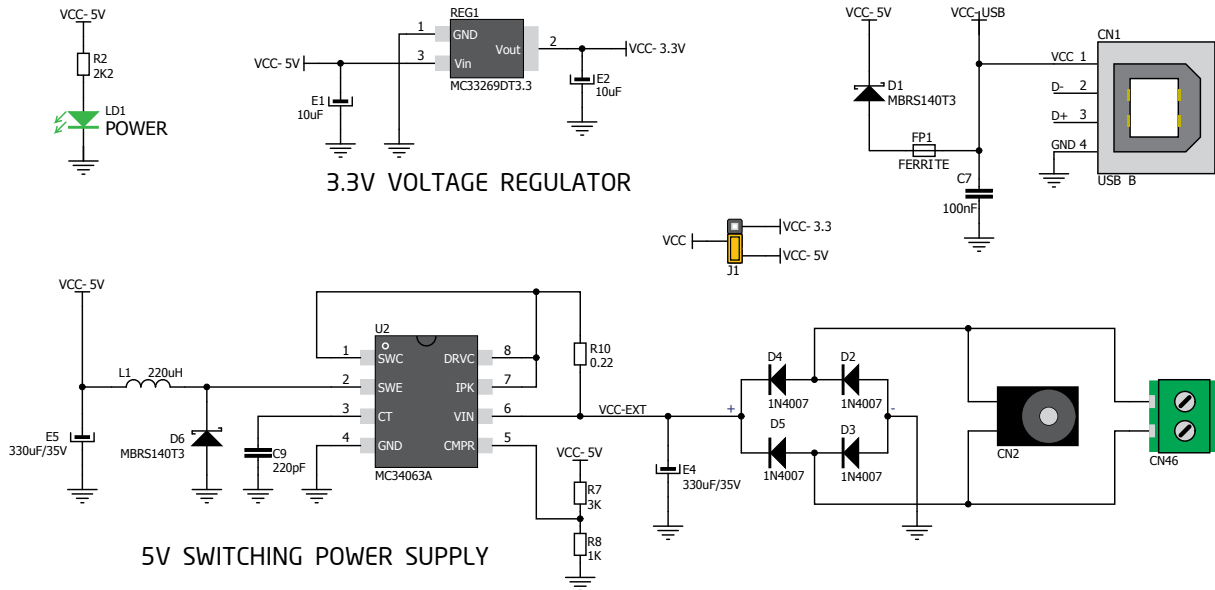


Figure 1-4: Power supply schematic

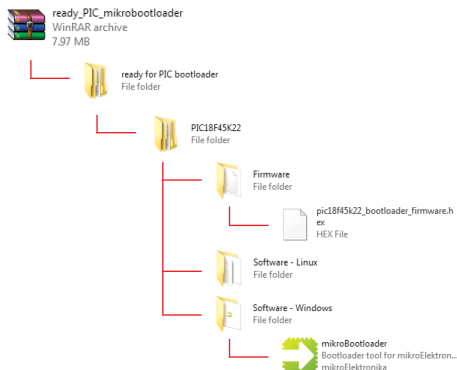
## 2. Programming with mikroBootloader

You can program the microcontroller with the bootloader that is preprogrammed into the device by default. To transfer .hex file from a PC to the MCU you need the bootloader software (**mikroBootloader**) which can be downloaded from:



[http://www.mikroe.com/eng/downloads/get/1808/ready\\_pic\\_mikrobootloader.zip](http://www.mikroe.com/eng/downloads/get/1808/ready_pic_mikrobootloader.zip)

After the software is downloaded unzip it to the desired location and start **mikroBootloader** software.



## mikroBootloader software

**note** Before starting mikroBootloader, connect Ready for PIC® to a PC using the USB cable provided with the package

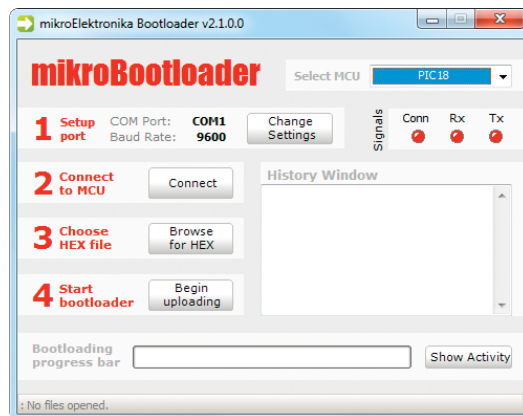


Figure 2-1: mikroBootloader window

01 When you start mikroBootloader, a window as shown in **Figure 2-1** should appear.

## Identifying device COM port

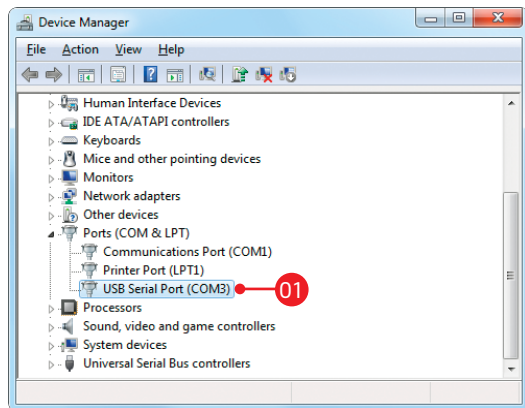


Figure 2-2: Identifying COM port

- 01 Open **Device Manager** window and expand **Ports** section to see which COM port is assigned to Ready for PIC® board (in this case it is COM3)

## step 1 - Choosing COM port

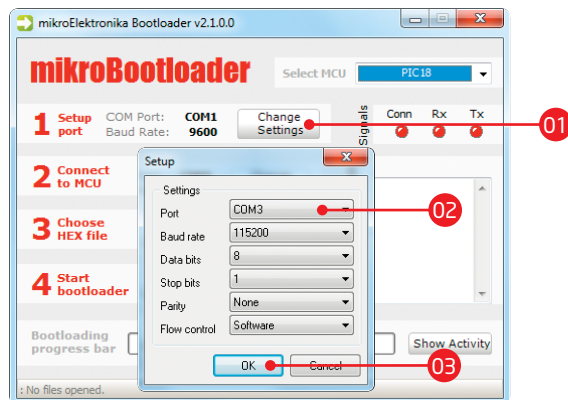


Figure 2-3: Choosing COM port

- 01 Click the **Change Settings** button
- 02 From the drop down list, select appropriate COM port (in this case it is COM3)
- 03 Click **OK**

## step 2 - Establishing connection

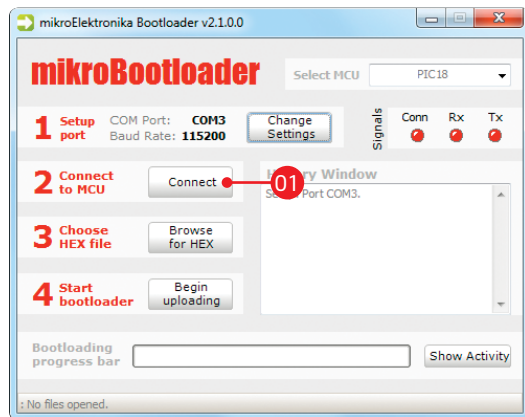


Figure 2-4: Connecting with mikroBootloader

- 01** Press the **Reset** button on the Ready for PIC® board and click the **Connect** button within 5s, otherwise the existing microcontroller program will run. If connected, the button's caption will be changed to **Disconnect**

## step 3 - Browsing for .HEX file

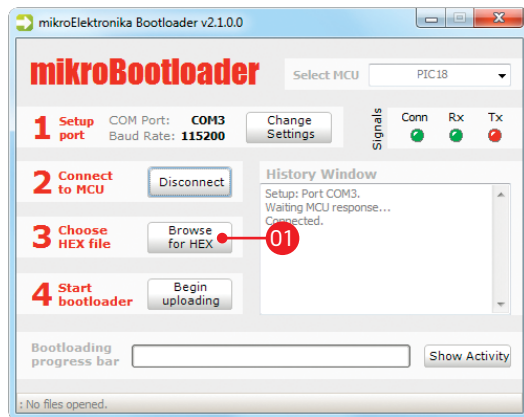


Figure 2-5: Browse for HEX

- 01** Click the **Browse for HEX** button and from a pop-up window (**Figure 2-6**) choose a .HEX file to be uploaded to MCU memory

## step 4 - Selecting .HEX file

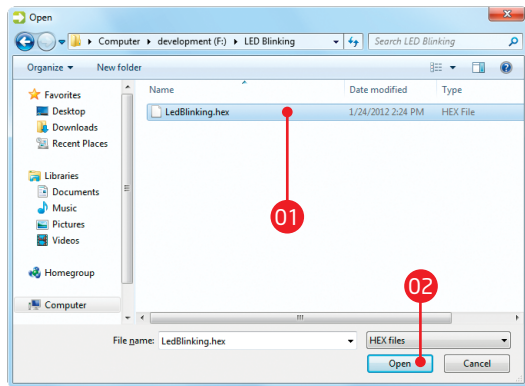


Figure 2-6: Locating and selecting .hex file

- 01 Select the .HEX file using the Open dialog window
- 02 Click **Open**

## step 5 - Uploading .HEX file

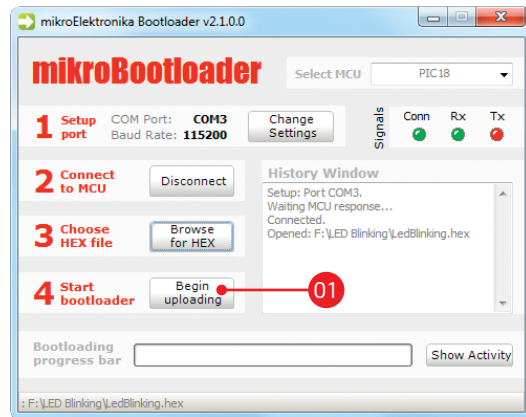


Figure 2-7: Begin uploading

- 01 To start .HEX file bootloading click the **Begin uploading** button

## step 6 - Progress bar

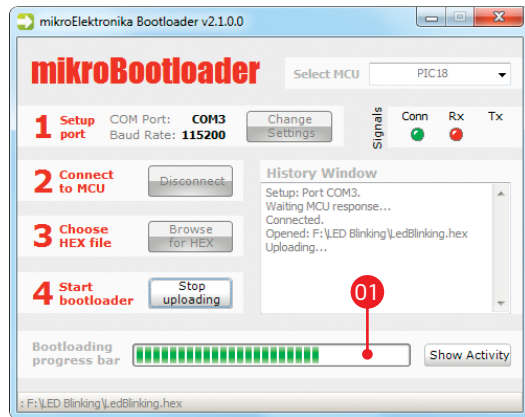


Figure 2-8: Progress bar

01 You can monitor .HEX file uploading via progress bar

## step 7 - Finishing upload

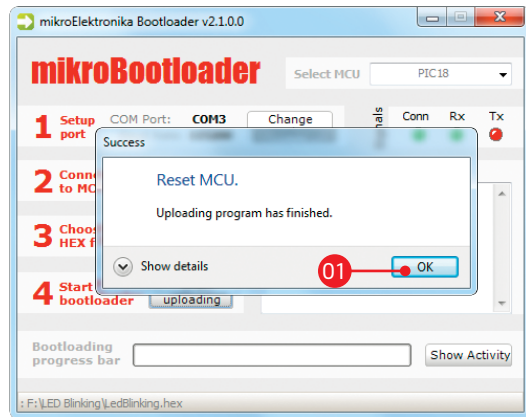


Figure 2-9: Restarting MCU

- 01 Click **OK** after the uploading process is finished
- 02 Press the **Reset** button on the Ready for PIC® board and wait for 5 seconds. Your program will run automatically

## 3. Programming with mikroProg™ programmer

The board is equipped with **mikroProg™ connector pads**, which allow you to program the microcontroller using external mikroProg™ programmer. Before attaching the programming connector, it is necessary to make a few adjustments (**Page 16**).

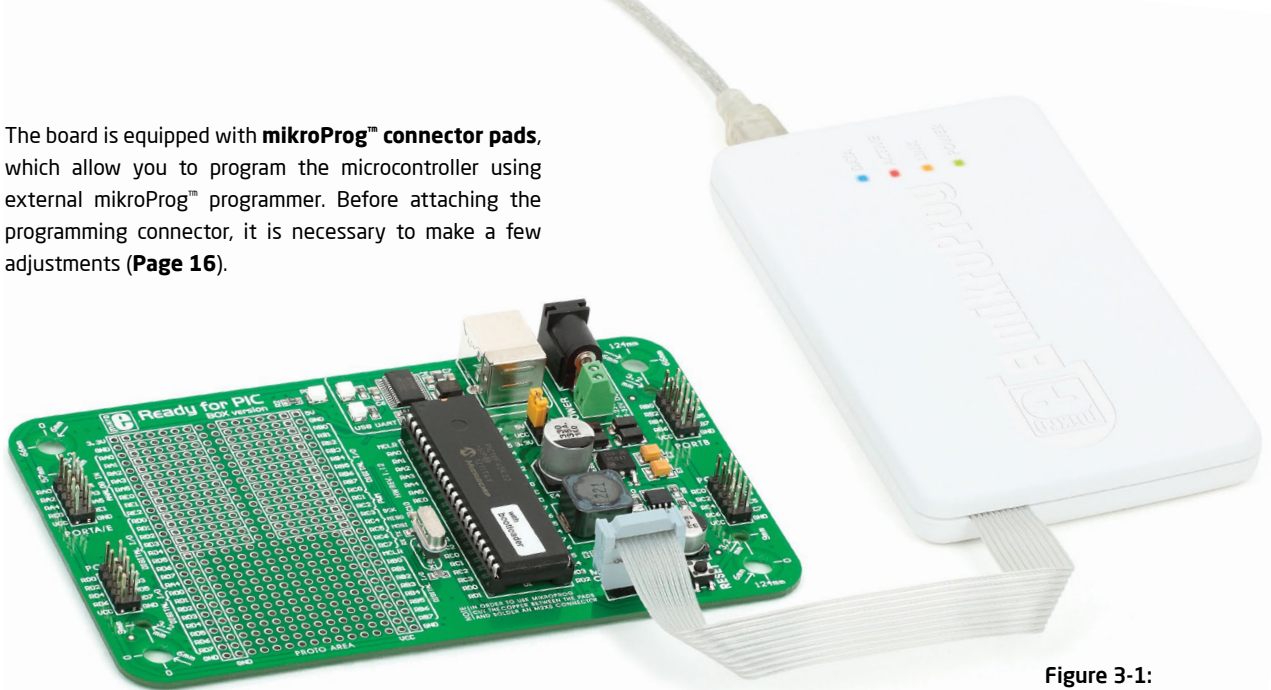


Figure 3-1:  
mikroProg™  
programmer



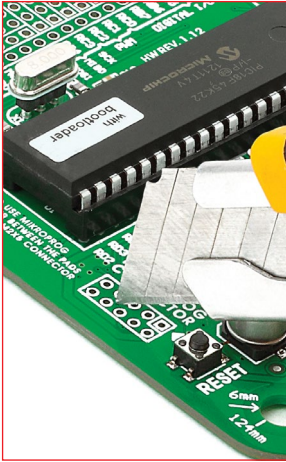


Figure 3-2: cutting copper between pads

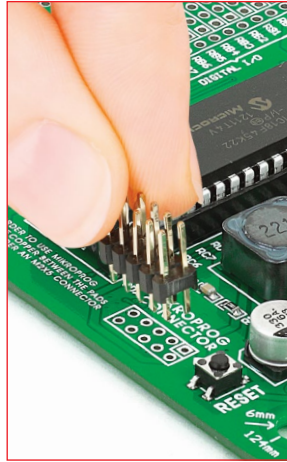


Figure 3-3: placing 2x5 male header

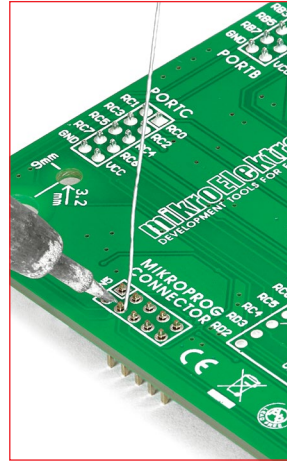


Figure 3-4: soldering 2x5 male header on the pads

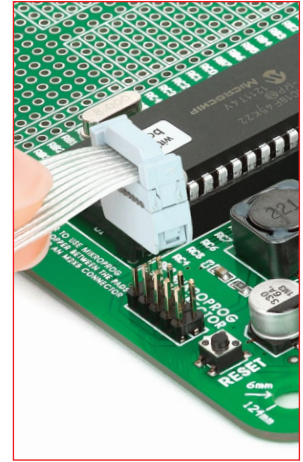


Figure 3-5: Connecting mikroProg™ programmer

First you need to cut the copper between pads for the external programmer, **Figure 3-2**. By doing so pins RB6, RB7, MCLR and VCC on the MCU will be separated from the rest of the board. After that it is time to place (**Figure 3-3**) and solder (**Figure 3-4**) a 2x5 male header on the pad (**CN5**). Now attach the external mikroProg™ programmer connector on the 2x5 header, **Figure 3-5**. After the programming process is finished you can remove the programmer connector and solder jumpers over pads in order to enable pins RB6, RB7 to be used as I/O pins and MCLR to be used as a reset pin.

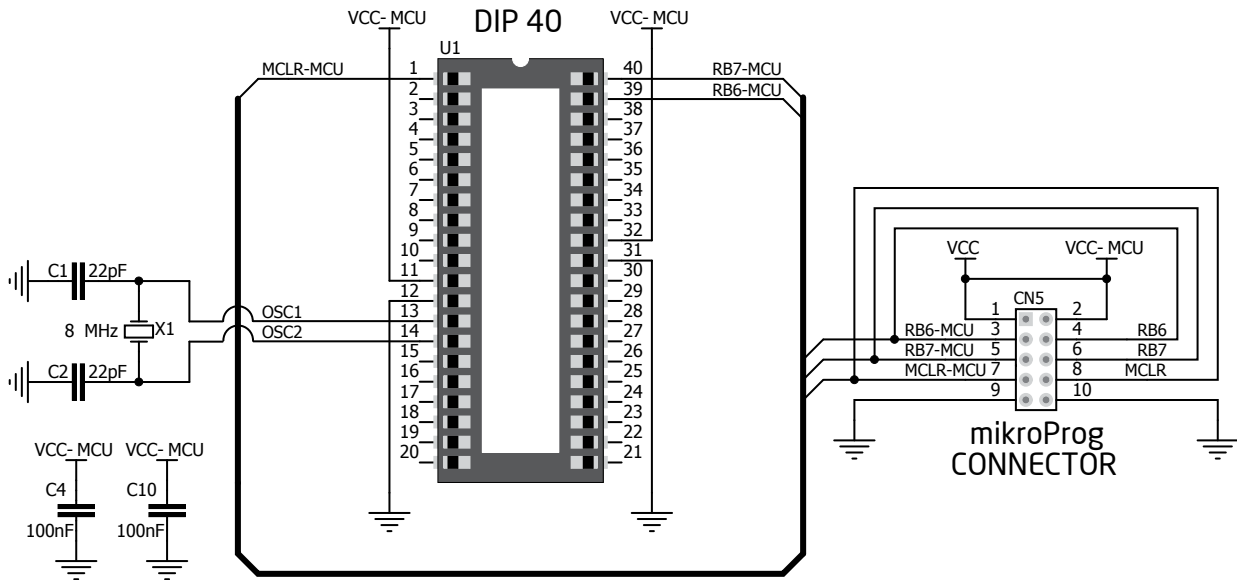


Figure 3-6: mikroProg™ programmer connection schematic

## 4. USB-UART

Fast on-board **FTDI® chip** allows Ready for PIC® to communicate with a PC or other UART devices using a USB-UART connection. USB-B connector (**CN1**) is used for connecting the USB cable. RX (receive) and TX (transmit) LEDs will indicate communication status. Before connecting the board to a PC, make sure that you have the appropriate **FTDI drivers** installed on your operating system. Drivers can be found at the following URL:



<http://www.ftdichip.com/Drivers/VCP.htm>

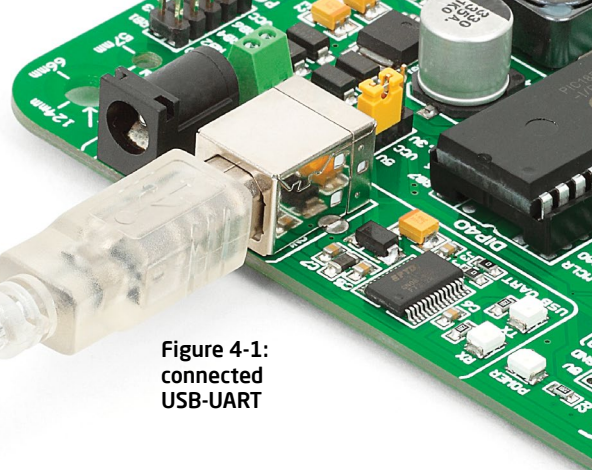


Figure 4-1:  
connected  
USB-UART

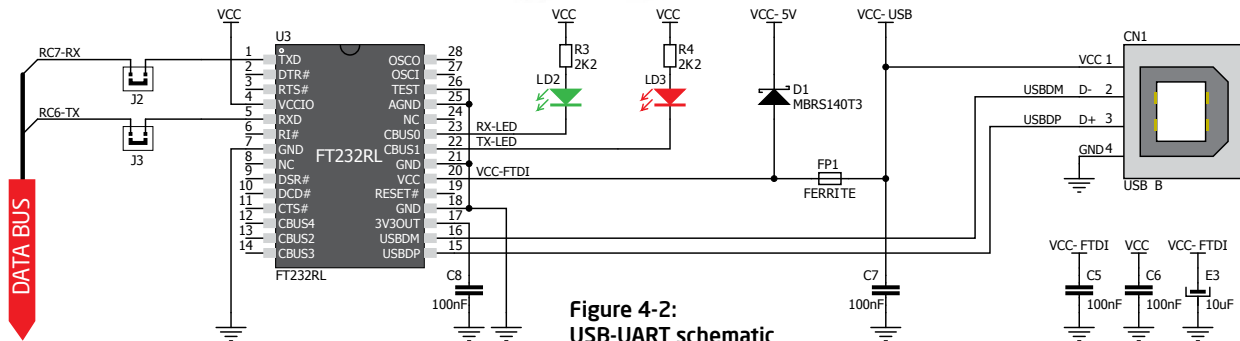


Figure 4-2:  
USB-UART schematic

## 5. Prototyping area

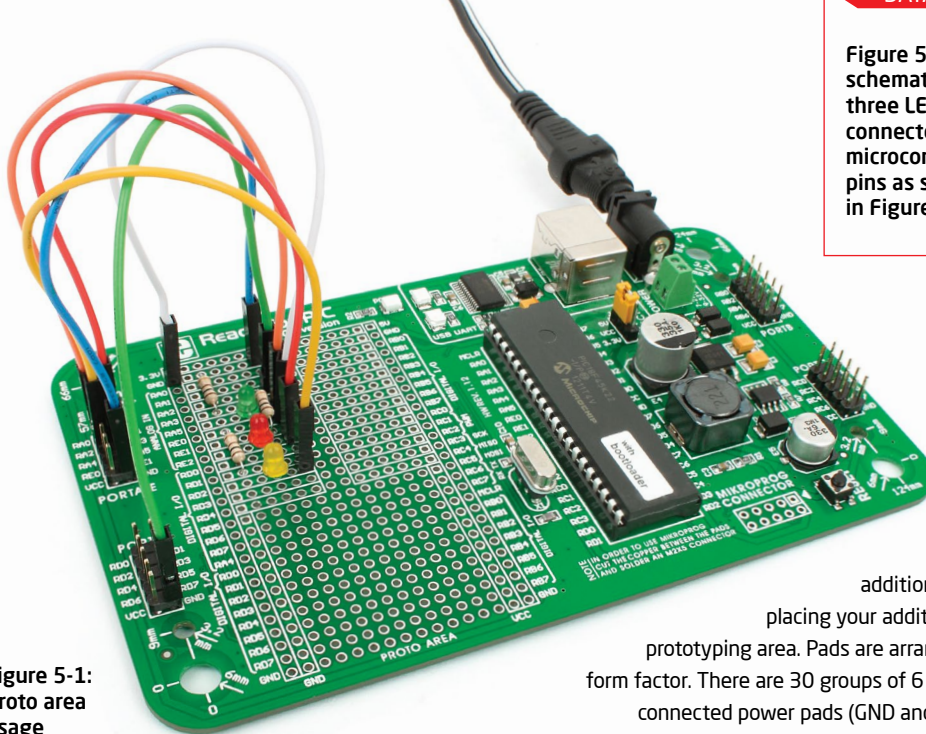
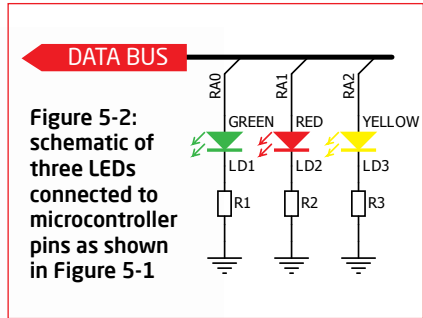
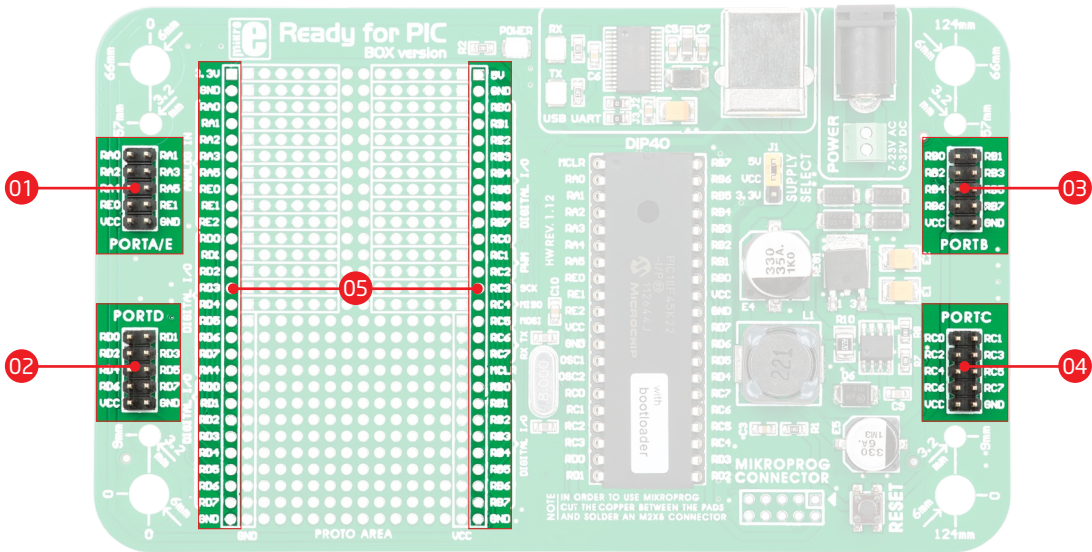


Figure 5-1:  
Proto area  
usage



**Proto area**  
allows you to expand  
your Ready for PIC® board with  
additional functionality. It can be done by  
placing your additional components on the available  
prototyping area. Pads are arranged in standard 100mils distance  
form factor. There are 30 groups of 6 connected pads, two groups of 13  
connected power pads (GND and VCC) and 186 unconnected pads.

## 6. Pin headers and connection pads



Each microcontroller pin is available for further connections through four on-board 2x5 connection headers and two 1x28 connection pads. Pins are grouped in four PORT groups (2x5 male headers) as well as per their functions (1x28 connection pads), which makes development and connections much easier. Everything is printed on the silkscreen, so that there will be no need of using microcontroller data sheet while developing. Before using the pins, it is necessary to solder **2x5 male headers** (1-4) on the board pads.

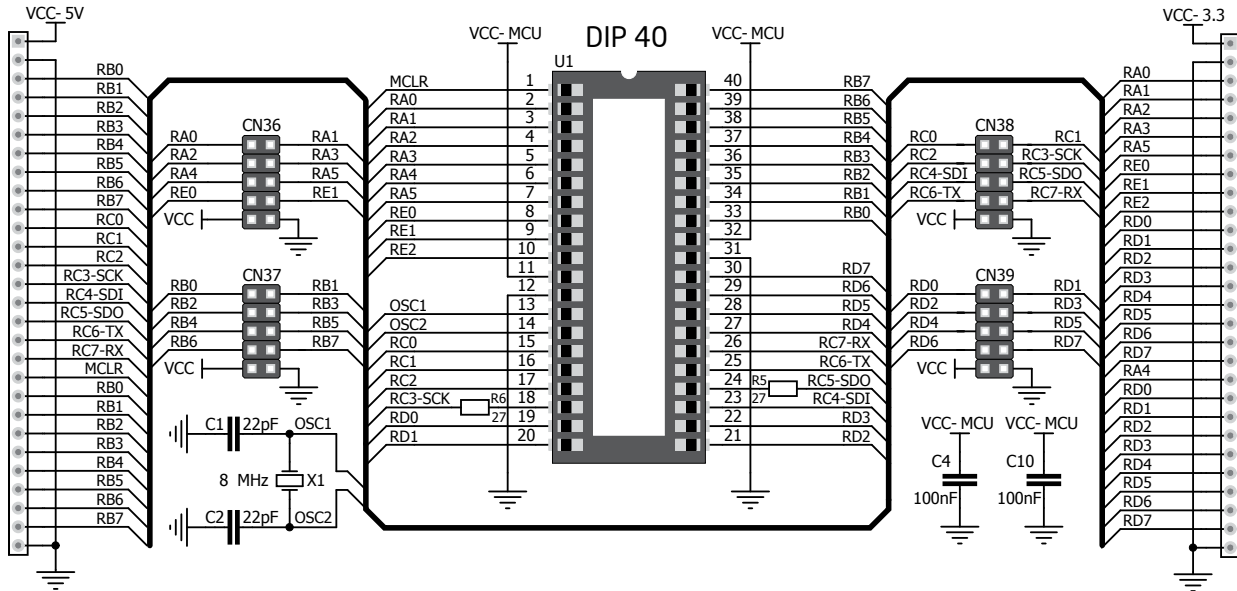


Figure 6-1: Schematic of pin headers and connection pads

# 7. Reset button

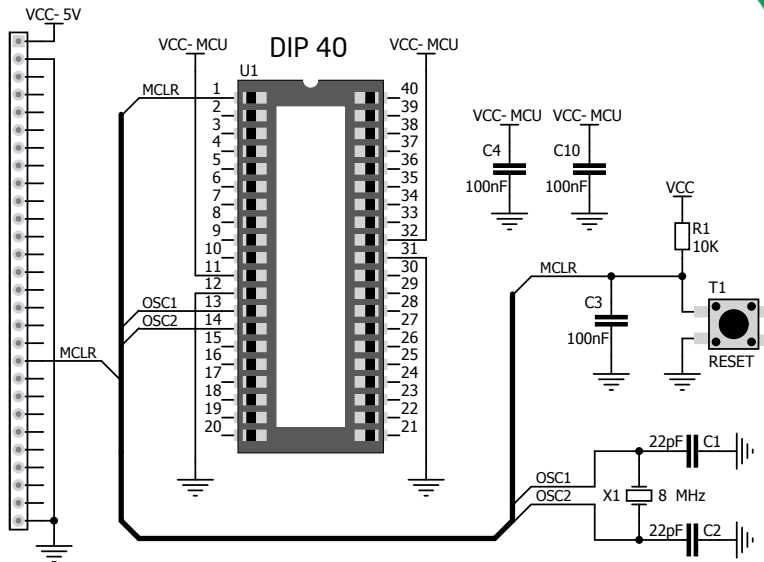


Figure 7-1:  
Reset button  
connection  
schematic

Ready for PIC® board has a specialized reset circuit with a high-quality reset button which can be used to reset the program execution of the microcontroller. If you want to reset the circuit, press the on-board RESET button. It will generate a low voltage level on the microcontroller reset pin (input). In addition, a reset can be externally generated through **MCLR pin** on 1x28 connection pads.



## 8. Integrating with the casing



**Figure 8-1:**  
Place the board into the bottom part of the casing. Make sure that the connectors are aligned with square openings



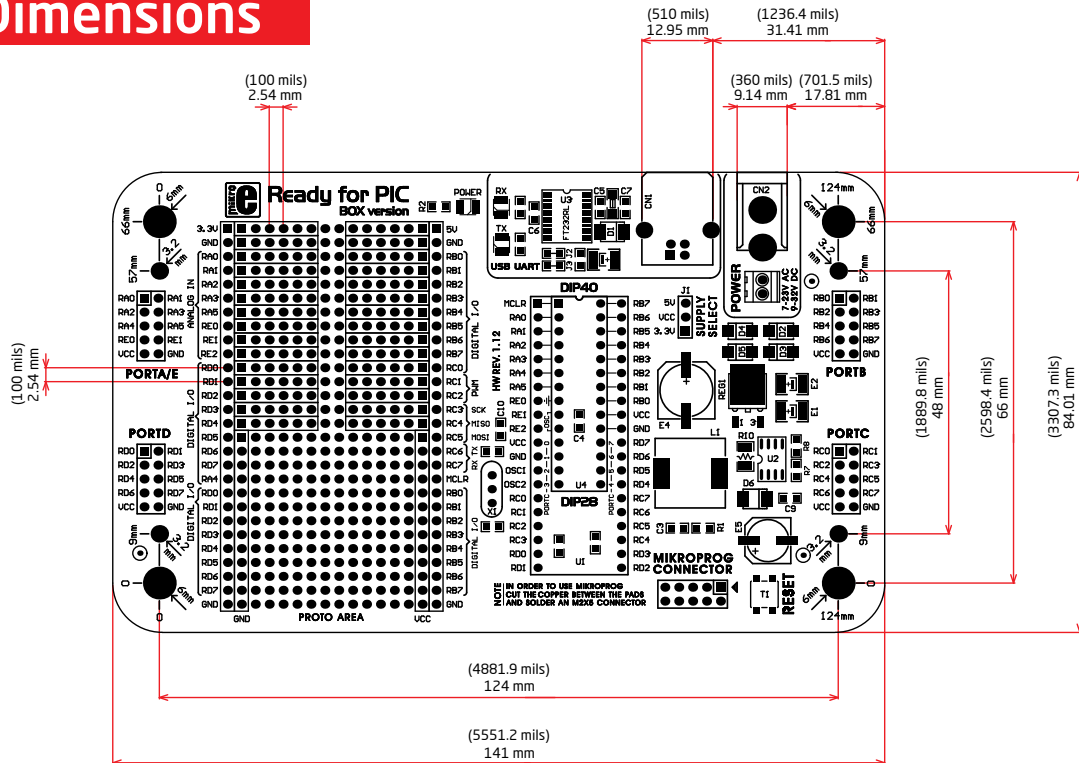
**Figure 8-2:**  
Wind screws into inner screw holes to fix the board with the bottom plastic casing

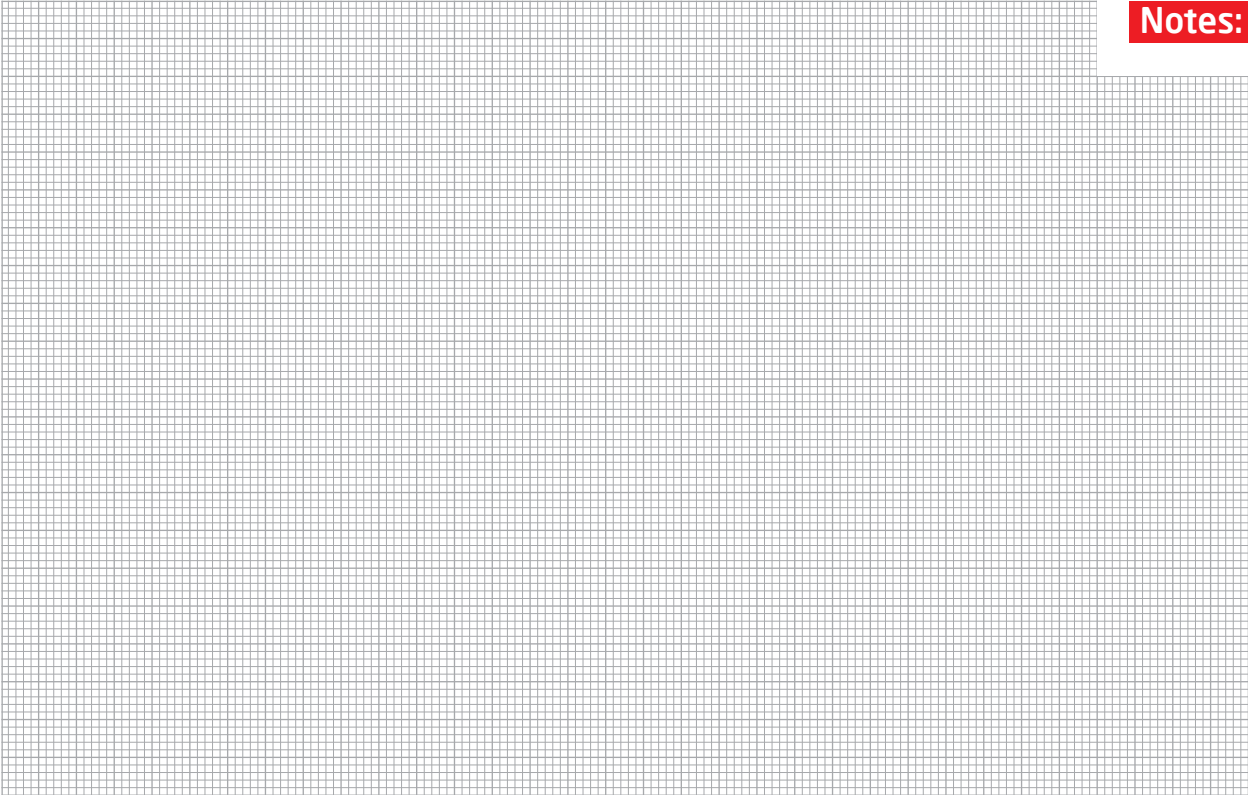


**Figure 8-3:**  
Place cover casing plastic and wind screws into outer screw holes to fix it with bottom plastics casing

Ready for PIC® can easily be integrated into the specialized white plastic casing. This feature is very convenient for turning the board into a final product. The white plastic casing contains inner and outer screw holes. Inner are used for fixing the board to the casing and outer are used for fixing the top part of the casing. Casing comes with holes for USB and power adapter connector, but you can customize it by drilling and cutting holes in specific areas, depending on the target application.

# 9. Dimensions





Notes:

## DISCLAIMER

All the products owned by MikroElektronika are protected by copyright law and international copyright treaty. Therefore, this manual is to be treated as any other copyright material. No part of this manual, including product and software described herein, may be reproduced, stored in a retrieval system, translated or transmitted in any form or by any means, without the prior written permission of MikroElektronika. The manual PDF edition can be printed for private or local use, but not for distribution. Any modification of this manual is prohibited.

MikroElektronika provides this manual 'as is' without warranty of any kind, either expressed or implied, including, but not limited to, the implied warranties or conditions of merchantability or fitness for a particular purpose.

MikroElektronika shall assume no responsibility or liability for any errors, omissions and inaccuracies that may appear in this manual. In no event shall MikroElektronika, its directors, officers, employees or distributors be liable for any indirect, specific, incidental or consequential damages (including damages for loss of business profits and business information, business interruption or any other pecuniary loss) arising out of the use of this manual or product, even if MikroElektronika has been advised of the possibility of such damages. MikroElektronika reserves the right to change information contained in this manual at any time without prior notice, if necessary.

## HIGH RISK ACTIVITIES

The products of MikroElektronika are not fault - tolerant nor designed, manufactured or intended for use or resale as on - line control equipment in hazardous environments requiring fail - safe performance, such as in the operation of nuclear facilities, aircraft navigation or communication systems, air traffic control, direct life support machines or weapons systems in which the failure of Software could lead directly to death, personal injury or severe physical or environmental damage ('High Risk Activities'). MikroElektronika and its suppliers specifically disclaim any expressed or implied warranty of fitness for High Risk Activities.

## TRADEMARKS

The MikroElektronika name and logo, mikroC™, mikroBasic™, mikroPascal™, mikroProg™, Ready™, mikroBUS™, EasyPIC™, click™ boards and mikromedia™ are trademarks of MikroElektronika. All other trademarks mentioned herein are property of their respective companies.

All other product and corporate names appearing in this manual may or may not be registered trademarks or copyrights of their respective companies, and are only used for identification or explanation and to the owners' benefit, with no intent to infringe.



If you want to learn more about our products, please visit our website at [www.mikroe.com](http://www.mikroe.com)

If you are experiencing some problems with any of our products or just need additional information, please place your ticket at [www.mikroe.com/support](http://www.mikroe.com/support)

If you have any questions, comments or business proposals,  
do not hesitate to contact us at [office@mikroe.com](mailto:office@mikroe.com)

Ready for PIC (DIP40) Manual  
ver. 1.12a

