

## Metal (Oxide) Film Resistors

Type: **ERG(X)S (Small size)**  
(0.5 W, 1 W, 2 W, 3 W, 5 W)

**ERG(X)F (Anti-heat conducting for PCB)**  
(1 W, 2 W, 3 W, 5 W)



### Features

- Miniaturized  
50 % smaller compared to existing models
- Non-flammable
- High Reliability
- Automatic Insertion
- Reference Standards  
IEC 60115-2, IEC 60115-4, JIS C 5201-4, EIAJ RC-2138
- RoHS compliant

### Explanation of Part Numbers

Ex.1 : ERX type

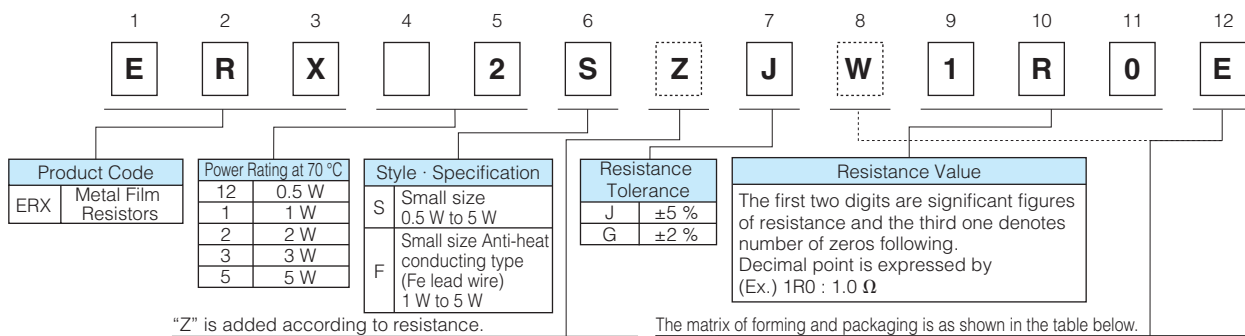

"Z" is added according to resistance.

Part No.	Resistance Tolerance	Resistance Value Range (Ω)	
		ERX□□SZ	ERX□□S
ERX12S	±5 %	0.10 to 0.18	0.20 to 9.1
	±2 %	0.10 to 0.91	1.0 to 9.1
ERX1S	±5 %	0.10 to 0.18	0.20 to 9.1
	±2 %	0.10 to 0.91	1.0 to 9.1
ERX2S	±5 %	0.10 to 0.20	0.22 to 9.1
	±2 %	0.10 to 0.91	1.0 to 9.1
ERX3S	±5 %	0.10 to 0.20	0.22 to 9.1
	±2 %	0.10 to 0.91	1.0 to 9.1
ERX5S	±5 %	—	0.33 to 9.1
	±2 %	—	1.0 to 9.1

The matrix of forming and packaging is as shown in the table below.

Code	Forming / Packaging	Forming & Taping matrix								
		12S	1S	2S	3S	5S	1F	2F	3F	5F
□··□	Straight lead wire type	○	○	○	○	○	○	○	○	○
□··P	Cut & Forming type	○	○	○	○	○	○	○	○	○
□··V	Axial taping type (Straight lead)	○	○	○	○		○	○	○	
U··V	Axial taping type (Stand off)		○	○	○					
□··E	Radial taping type (E type)	○	○	○						
W··E	Radial taping type (WE type)	○	○	○	○					
□··H	Cut & Forming type						○	○	○	○
S··E	Radial taping type (SE type)						○	○	○	

The above example 1 shows a small metal film resistor, 2 W power rating, resistance value of 1.0 Ω, tolerance ±5 %, and package of radial taping.

Ex.2 : ERG type

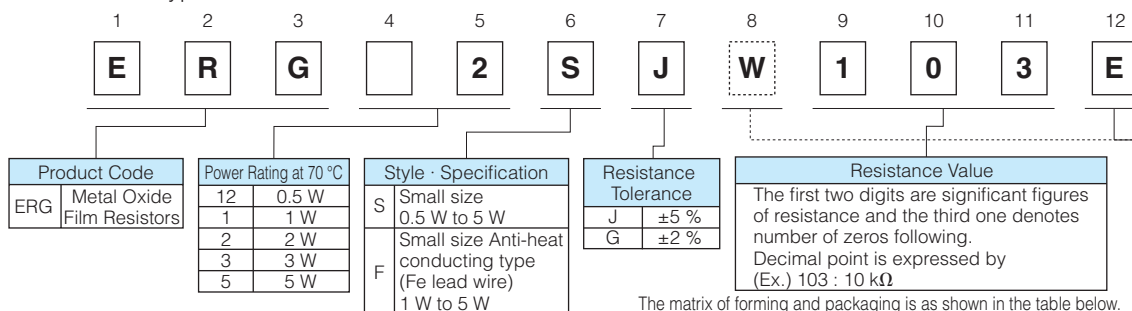

The matrix of forming and packaging is as shown in the table below.

Code	Forming / Packaging	Forming & Taping matrix								
		12S	1S	2S	3S	5S	1F	2F	3F	5F
□··□	Straight lead wire type	○	○	○	○	○	○	○	○	○
□··P	Cut & Forming type	○	○	○	○	○	○	○	○	○
□··V	Axial taping type (Straight lead)	○	○	○	○		○	○	○	
U··V	Axial taping type (Stand off)		○	○	○					
□··E	Radial taping type (E type)	○	○	○						
W··E	Radial taping type (WE type)	○	○	○	○					
□··H	Cut & Forming type						○	○	○	○
S··E	Radial taping type (SE type)						○	○	○	

The above example 2 shows a small metal oxide film resistor, 2 W power rating, resistance value of 10 kΩ, tolerance ±5 %, and package of radial taping.

## Construction

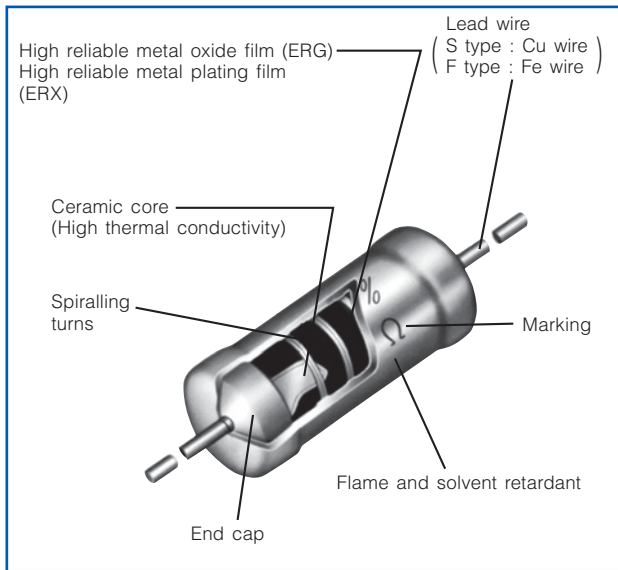

## Dimensions in mm (not to scale)

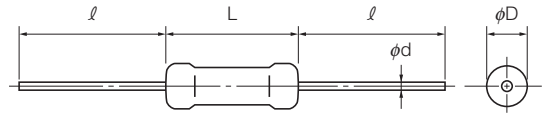

Part No.	Dimensions (mm)				Mass (Weight) [g/pc.]
	L	$\phi D$	$l$	$\phi d$	
ERG(X)12S	$6.35^{+0.65}_{-0.35}$	$2.3^{+0.5}_{-0.3}$	$30.0^{\pm 3.0}$	$0.65^{\pm 0.05}$	0.26
ERG(X)1S	$9.00^{+1.50}_{-1.00}$	$2.8^{\pm 0.5}$	$30.0^{\pm 3.0}$	$0.65^{\pm 0.05}$	0.33
ERG(X)1F				$0.80^{\pm 0.05}$	
ERG(X)2S	$12.00^{+1.50}_{-1.00}$	$4.0^{\pm 1.0}$	$30.0^{\pm 3.0}$	$0.80^{\pm 0.05}$	0.66
ERG(X)2F					
ERG(X)3S	$15.00^{\pm 1.50}$	$5.5^{\pm 1.0}$	$38.0^{\pm 3.0}$	$0.80^{\pm 0.05}$	1.47
ERG(X)3F					
ERG(X)5S	$24.00^{\pm 1.50}$	$8.0^{\pm 1.0}$	$38.0^{\pm 3.0}$	$0.80^{\pm 0.05}$	3.54
ERG(X)5F					

## Ratings

Part No.	Power Rating at 70 °C (W)	Limiting Element Voltage <sup>(1)</sup> (V)	Maximum Overload Voltage <sup>(2)</sup> (V)	Maximum Intermittent Overload Voltage <sup>(3)</sup> (V)	Dielectric Withstanding Voltage (VAC)	Res. Tol. (%) <sup>(4)</sup>	Resistance Range ( $\Omega$ ) <sup>(5)</sup>		T.C.R. ( $\times 10^{-6}/^{\circ}\text{C}$ )	Standard Resistance Value
							min. <sup>(6)</sup>	max.		
ERG(X)12S	0.5	300	600	600	350	G ( $\pm 2$ ) J ( $\pm 5$ )	1 0.2	22 k 47 k	$\pm 350$	E24
ERG(X)1S ERG(X)1F	1	350	600	600	350	G ( $\pm 2$ ) J ( $\pm 5$ )	1 0.2	68 k 100 k	$\pm 350$	E24
ERG(X)2S ERG(X)2F	2	350	700	1000	600	G ( $\pm 2$ ) J ( $\pm 5$ )	1 0.22	100 k 100 k	$\pm 350$	E24
ERG(X)3S ERG(X)3F	3	350	700	1000	1000	G ( $\pm 2$ ) J ( $\pm 5$ )	1 0.22	100 k 100 k	$\pm 300$	E24
ERG(X)5S ERG(X)5F	5	500	1000	1500	1000	G ( $\pm 2$ ) J ( $\pm 5$ )	1 0.33	100 k 100 k	$\pm 200$	E24

- (1) Rated Continuous Working Voltage (RCWV) shall be determined from  $RCWV = \sqrt{\text{Power Rating} \times \text{Resistance Value}}$  or Limiting Element Voltage listed above whichever less.
- (2) Overload (Short-time Overload) Test Voltage (SOTV) shall be determined from  $SOTV = 2.5 \times \text{Power Rating}$  or max. Overload Voltage listed above whichever less.
- (3) Intermittent Overload Test Voltage (IOTV) shall be determined from  $IOTV = 4.0 \times \text{Power Rating}$  or max. Intermittent Overload Voltage listed above whichever less.

- (4) Resistance tolerance is of use besides range listed, please inquire.
- (5) Resistance Range Type ERG :  $\geq 10 \Omega$   
Type ERX :  $\leq 9.1 \Omega$
- (6) As for the low resistance value range, "Z" is given to the part number. (Refer to the explanation of part numbers.)

\* Z type is non standard resistance values.

Code	Part No.	Res. Tol.	Res. Value Range	Code	Part No.	Res. Tol.	Res. Value Range
Z	12S	$\pm 2\%$	0.1 to 0.91 $\Omega$	Z	2S	$\pm 2\%$	0.1 to 0.91 $\Omega$
		$\pm 5\%$	0.1 to 0.18 $\Omega$		2F	$\pm 5\%$	0.1 to 0.2 $\Omega$
	$\pm 2\%$	0.1 to 0.91 $\Omega$	3S		$\pm 2\%$	0.1 to 0.91 $\Omega$	
	$\pm 5\%$	0.1 to 0.18 $\Omega$	3F		$\pm 5\%$	0.1 to 0.2 $\Omega$	

### Power Derating Curve

For resistors operated in ambient temperatures above 70 °C, power rating shall be derated in accordance with the figure on the right.

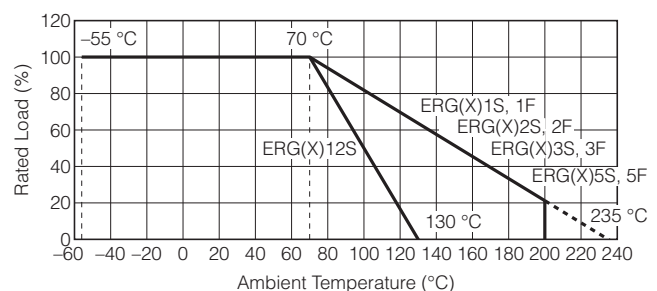

## Taped & Box

ERG(X)□□S□□□□V

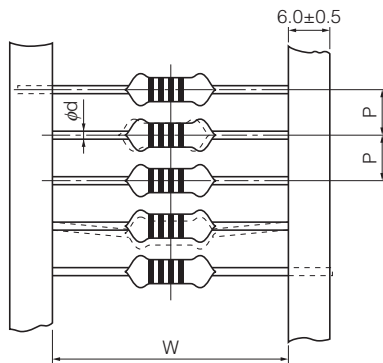

## Stand-off Taped & Box

ERG(X)□□S□□□□V

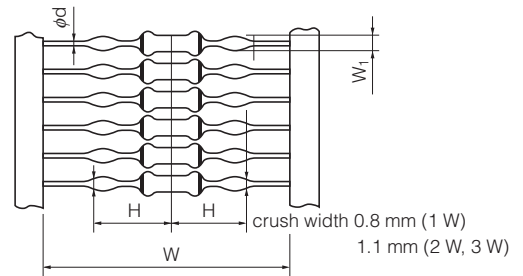

Part Number	Standard Quantity (pcs./box)	Taping (mm)						Box (mm)		
		P	50×P	W	H	W <sub>1</sub>	φd	a	b	c
ERG(X) 12S□□□□□V	2,000	5.0 <sup>+0.3</sup>	250 <sup>+2</sup>	52.0 <sup>+1.5</sup>	—	—	0.65 <sup>+0.05</sup>	85	80	255
ERG(X) 1S□□□□□V	2,000	5.0 <sup>+0.3</sup>	250 <sup>+2</sup>	52.0 <sup>+1.5</sup>	—	—	0.65 <sup>+0.05</sup>	85	80	255
ERG(X) 1S□□□□□V					12.0 <sup>-0.2</sup>	1.20 <sup>+0.15</sup> <sub>0</sub>				
ERG(X) 2S□□□□□V	1,000	5.0 <sup>+0.3</sup>	250 <sup>+2</sup>	52.0 <sup>+1.5</sup>	—	—	0.80 <sup>+0.05</sup>	85	80	255
ERG(X) 2S□□□□□V					15.5 <sup>-0.2</sup>	1.40 <sup>+0.15</sup> <sub>0</sub>				
ERG(X) 3S□□□□□V	1,000	10.0 <sup>+0.5</sup>	500 <sup>+2</sup>	74.0 <sup>+2.0</sup>	—	—	0.80 <sup>+0.05</sup>	105	100	325
ERG(X) 3S□□□□□V					23.0 <sup>-0.2</sup>	1.4 <sup>+0.15</sup> <sub>0</sub>				

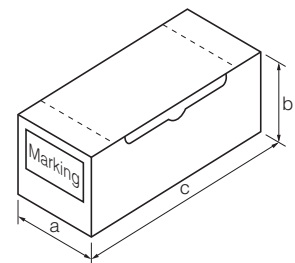

## Cut & Formed Type

ERG(X)□□S□□□□P

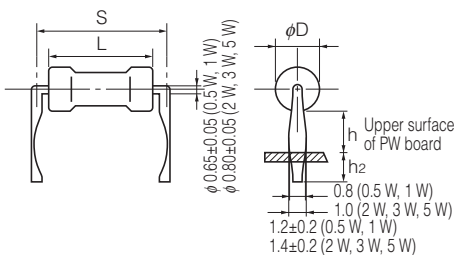

Part Number	Standard Quantity (pcs./box)	Dimensions (mm)				
		L	φD	S	h	h <sub>2</sub>
ERG(X) 12S□□□□□P	1,000	6.35 <sup>+0.65</sup> <sub>-0.35</sub>	2.3 <sup>+0.5</sup> <sub>0.3</sub>	10.0 <sup>+1.5</sup>	4.0 <sup>+1.5</sup>	4.0 <sup>+1.5</sup>
ERG(X) 1S□□□□□P	1,000	9.00 <sup>+1.50</sup> <sub>-1.00</sub>	2.8 <sup>+0.5</sup>	12.5 <sup>+1.5</sup>	4.0 <sup>+1.5</sup>	4.0 <sup>+1.5</sup>
ERG(X) 2S□□□□□P	1,000	12.00 <sup>+1.50</sup> <sub>-1.00</sub>	4.0 <sup>+1.0</sup>	15.0 <sup>+1.5</sup>	6.0 <sup>+1.5</sup>	4.0 <sup>+1.5</sup>
ERG(X) 3S□□□□□P	1,000	15.00 <sup>+1.50</sup>	5.5 <sup>+1.0</sup>	20.0 <sup>+2.0</sup>	6.5 <sup>+1.5</sup>	4.0 <sup>+1.5</sup>
ERG(X) 5S□□□□□P	500	24.00 <sup>+1.50</sup>	8.0 <sup>+1.0</sup>	30.0 <sup>+2.0</sup>	7.5 <sup>+1.5</sup>	4.0 <sup>+1.5</sup>

ERG(X)□□F□□□□□H

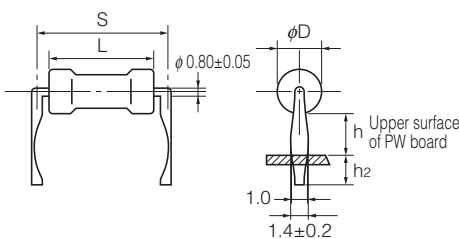

Part Number	Standard Quantity (pcs./box)	Dimensions (mm)				
		L	φD	S	h	h <sub>2</sub>
ERG(X) 1F□□□□□H	1,000	9.0 <sup>+1.5</sup> <sub>-1.0</sub>	2.8 <sup>+0.5</sup>	12.5 <sup>+1.5</sup>	8 <sup>+2</sup>	4.0 <sup>+1.5</sup>
ERG(X) 2F□□□□□H	1,000	12.0 <sup>+1.5</sup> <sub>-1.0</sub>	4.0 <sup>+1.0</sup>	15.0 <sup>+1.5</sup>	6 <sup>+2</sup>	5.0 <sup>+1.5</sup>
ERG(X) 3F□□□□□H	1,000	15.0 <sup>+1.5</sup>	5.5 <sup>+1.0</sup>	20.0 <sup>+2.0</sup>	10 <sup>+2</sup>	5.0 <sup>+1.5</sup>
ERG(X) 5F□□□□□H	500	24.0 <sup>+1.5</sup>	8.0 <sup>+1.0</sup>	30.0 <sup>+2.0</sup>	10 <sup>+2</sup>	5.0 <sup>+1.5</sup>

## For Panasert Automatic Insertion Machine Radial Taped & Box

ERG(X)□□S□□□□E (12S, 1S, 2S)

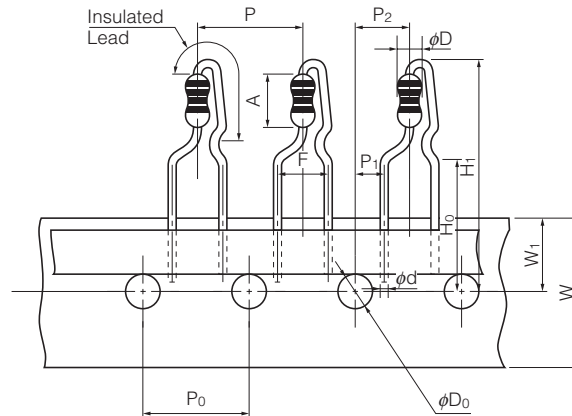

Dimensions (mm)		Dimensions (mm)		Dimensions (mm)		Dimensions (mm)		Dimensions (mm)	
P	12.7±1.0	W	18.0±0.5	H <sub>1</sub>	12S	32 max.	A	12S	6.35 <sup>+0.65</sup> <sub>-0.35</sub>
P <sub>0</sub>	12.7±0.3	W <sub>1</sub>	9.0±0.5		1S	32 max.		1S	9.0 <sup>+1.5</sup> <sub>-1.0</sub>
P <sub>1</sub>	3.85±0.70				2S	38 max.		2S	12.0 <sup>+1.5</sup> <sub>-1.0</sub>
P <sub>2</sub>	6.35±1.00			H <sub>0</sub>	16.0±0.5		phi d	0.65±0.05	
F	5.0±0.8			phi D <sub>0</sub>	4.0±0.2				

### ● Radial Tape Package Specifications

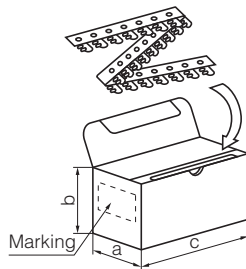

Part Number	Dimensions (mm)			Standard Quantity (pcs./box)
	a	b	c	
ERG(X) 12S□□□□□E	46	130	335	2,000
ERG(X) 1S□□□□□E	46	130	335	2,000
ERG(X) 2S□□□□□E	49	100	335	1,000

## For Panasert Automatic Insertion Machine Radial Taped & Box

ERG(X)□□S□W□□□□E (12S, 1S, 2S, 3S)

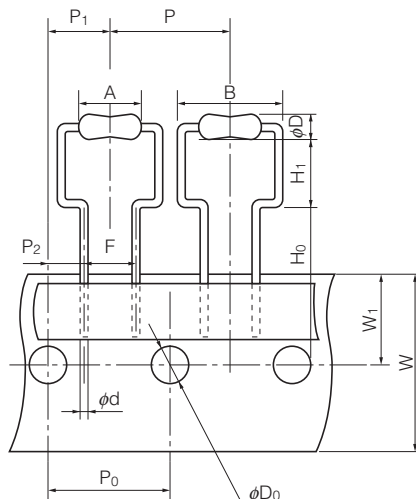

P	Dimensions (mm)		Dimensions (mm)		
			phi D <sub>0</sub>		
P	12S	12.7±1.0	A	12S, 1S, 2S, 3S	4.0±0.2
	1S, 2S, 3S	30.0±1.0		12S	6.35 <sup>+0.65</sup> <sub>-0.35</sub>
P <sub>0</sub>	12S	12.7±0.3	B	1S	9.0 <sup>+1.5</sup> <sub>-1.0</sub>
	1S, 2S, 3S	15.0±0.3		2S	12.0 <sup>+1.5</sup> <sub>-1.0</sub>
P <sub>1</sub>	12S	6.35±1.00	phi D	3S	15.0±1.5
	1S, 2S, 3S	7.5±1.0		12S	11.2 max.
P <sub>2</sub>	12S	3.85±0.70	phi d	1S	14.0 max.
	1S, 2S, 3S	3.75±0.50		2S	17.0 max.
F	12S	5.0±0.5	phi D	3S	21.0 max.
	1S, 2S, 3S	7.5±0.8		12S	2.3 <sup>+0.5</sup> <sub>-0.3</sub>
W	12S, 1S, 2S, 3S	18.0±0.5	phi D	1S	2.8±0.5
W <sub>1</sub>	12S, 1S, 2S, 3S	9.0±0.5		2S	4.0±1.0
H <sub>0</sub>	12S	16.0±0.5	phi d	3S	5.5±1.0
	1S, 2S	18.0±1.0		12S	phi 0.65±0.05
	3S	19.0±1.0		1S, 2S, 3S	phi 0.80±0.05
H <sub>1</sub>	12S	6.5 <sup>+0.6</sup> <sub>0</sub>	phi d		
	1S, 2S	6.5 <sup>+1.0</sup> <sub>0</sub>			
	3S	8.0 <sup>+1.0</sup> <sub>0</sub>			

## For Panasert Automatic Insertion Machine Radial Taped & Box

ERG(X)□F□S□□□E (1F, 2F, 3F)

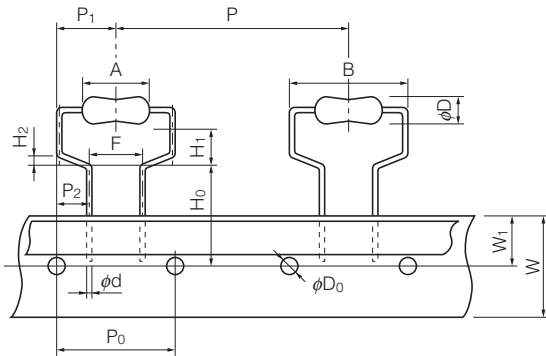

Dimensions (mm)		Dimensions (mm)	
P	30.0±1.0	H <sub>2</sub>	1.0±0.3
P <sub>0</sub>	15.0±0.3	φD <sub>0</sub>	4.0±0.2
P <sub>1</sub>	7.5±1.0	A	1F 9.0 <sup>+1.5</sup> <sub>-1.0</sub>
P <sub>2</sub>	3.75±0.50		2F 12.0 <sup>+1.5</sup> <sub>-1.0</sub>
F	7.5±0.8		3F 15.0±1.5
W	18.0±0.5	B	1F 14 max.
W <sub>1</sub>	9.0±0.5		2F 17 max.
H <sub>0</sub>	16.0 <sup>+1.0</sup> <sub>0</sub>		3F 21 max.
H <sub>1</sub>	1F	φD	1F 2.8±0.5
	2F		2F 4.0±1.0
	3F		3F 5.5±1.0
		φd	0.80±0.05

### ● Radial Tape Package Specifications

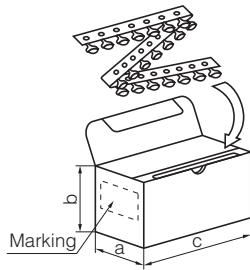

Part No.	Dimensions (mm)			Standard Quantity (pcs./box)
	a	b	c	
ERG(X)12S□W□□□E	46	145	325	2,000
ERG(X) 1S□W□□□E	49	150	317	1,000
ERG(X) 1F□ S□□□E				
ERG(X) 2S□W□□□E	49	150	317	500
ERG(X) 2F□ S□□□E				
ERG(X) 3F□ S□□□E	49	190	315	500

## Hot-spot Temperature (for Reference)

The temperature of the resistor body increases with the curve below. A touching vinyl wire may cause damages to resistor element. Do not place vinyl wires around resistors and be sure to consider where the resistors will be placed.

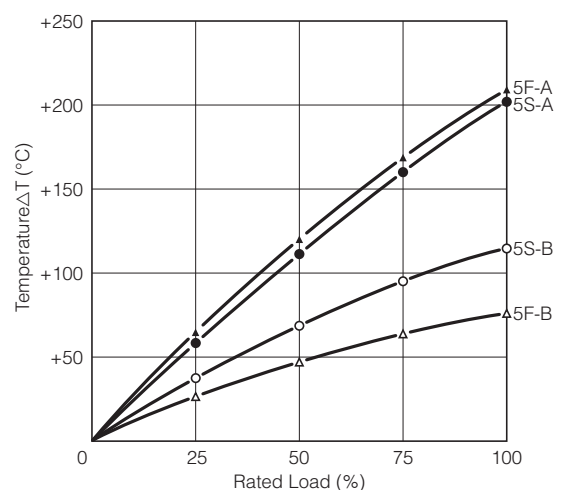
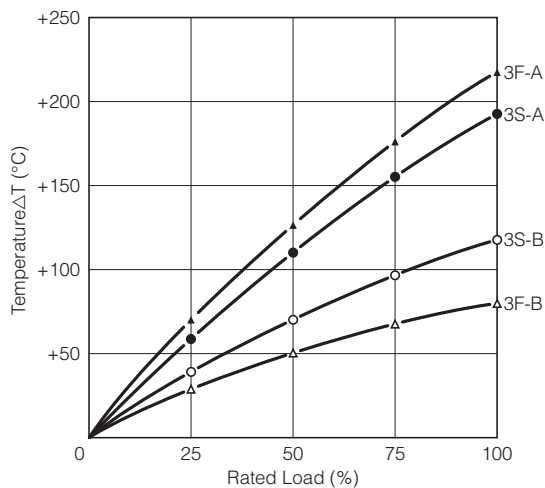
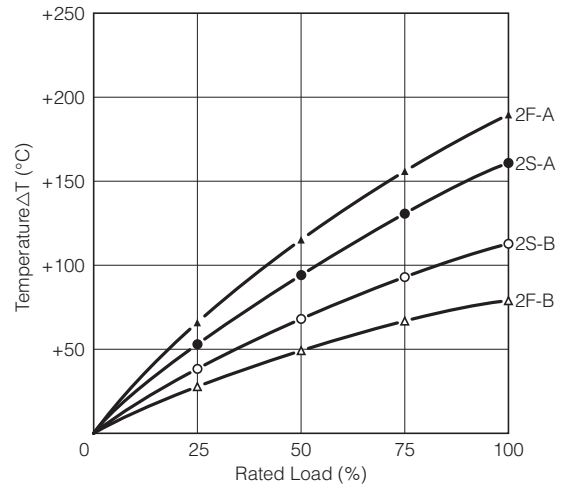
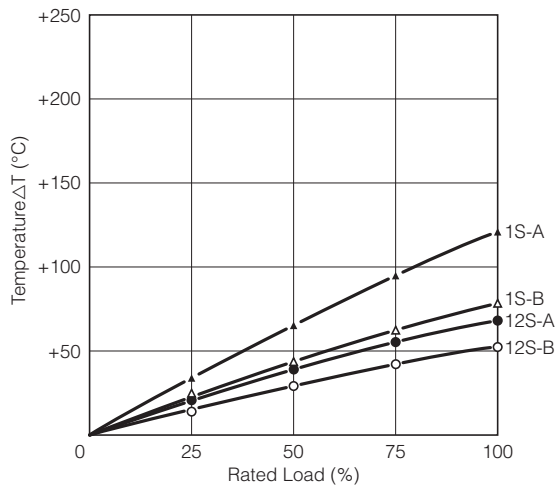
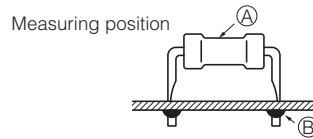

## ⚠ Safety Precautions

The following are precautions for individual products. Please also refer to the common precautions for Fixed Resistors shown on this catalog.

### 1. Transient voltage

If there is a possibility that the transient phenomenon (significantly high voltage applied in a short time) may occur or that a high voltage pulse may be applied, make sure to evaluate and check the characteristics of Metal(Oxide) Film Resistors (hereafter called the resistors) mounted on your product rather than only depending on the calculated power limit or steady-state conditions to complete the design or decide to use the resistors.

- The resistors are covered with a special coating. Do not apply shock or vibration to them, or pinch them with long-nose pliers. Otherwise, the resistors may be damaged.
- Do not apply excessive tension to the lead-connected sections. When bending the lead wire, do not apply excessive stress to the resistors and provide the wire with a natural curvature.
- Do not brush the resistors during or after the cleaning process, which may be conducted after soldering. Otherwise, the coating film may be damaged.

(Data for Reference)

## Pulse Characteristics (Usual)

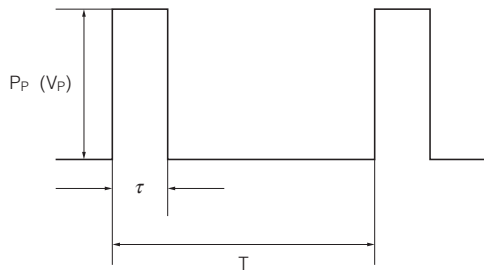

$P_p$  : Pulse limit power (W)  
 $V_p$  : Pulse limit voltage (V)  
 $\tau$  : Pulse continuous time (s)  
 $T$  : Period (s)  
 $V_R$  : Rated voltage (V)  
 $P$  : Rated power (W)  
 $R$  : Resistance value ( $\Omega$ )  
 $V_{p\ max.}$  : Max. pulse limit voltage (V)

Withstand pulse limit power is calculated by the next method.

$$P_p = K \cdot P \cdot T / \tau$$

$$V_p = \sqrt{K \cdot P \cdot R \cdot T / \tau}$$

Reference to the right about a fixed number of  $V_{p\ max.}$

- $T > 1(s) \rightarrow T = 1(s)$
- $T / \tau > 100 \rightarrow T / \tau = 100$
- $P_p < P \rightarrow P$  stands for  $P_p$   
( $V_p < V_R \rightarrow V_R$  stands for  $V_p$ )
- Added voltage  $\leq V_{p\ max.}$
- $P_p$  or  $V_p$  is referent value  
Conditions: Pulse added time=1000 h  
Resistance change= $\pm 5\%$   
Room temperature

Part No.	K	$V_{p\ max.}$ (V)
ERG(X) 12S	0.5	600
ERG(X) 1S	0.5	600
ERG(X) 2S	0.5	700
ERG(X) 3S	0.5	700
ERG(X) 5S	0.5	1000