

USB Type-C™ Compatible  
**DX07 Series**  
**Waterproof Receptacle**

CONNECTOR  
 MB-0333-3  
 March 2019

**RoHS Compliant**

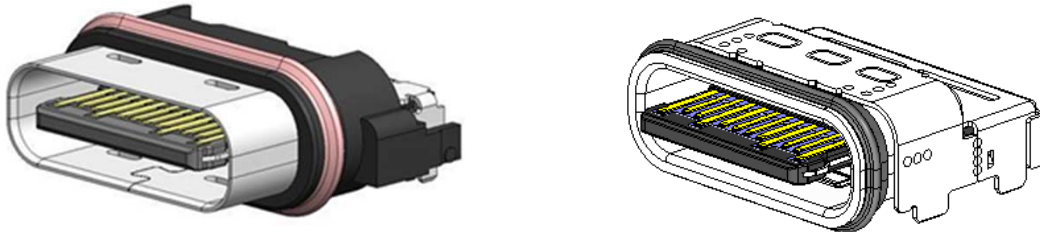

The waterproof DX07 Series connectors are USB Type-C™ compliant, and have become a popular standard interface for personal computers, mobile devices, audiovisual equipment, and portable gaming devices.

It is an individually waterproof receptacle connector which provides a solution to the ever growing trend of waterproofing portable devices.

Note) USB Type-C™ is a trademark of USB Implementers Forum, Inc.

#### Applicable Waterproof Products

Smartphones, tablets, waterproof speakers, Bluetooth earphones / headphones, action camera, VR / AR headset, and others

#### Features

- USB Type-C compatible waterproof receptacle
- Waterproof performance rating of IPX7 or higher
- Supports up to 5A as power supply.
- Symmetric interface which allows for the plug to be inserted upside down or right side up
- Lock structure with superior durability

Remarks: Large selection of other connector variations available in DX07 Series  
 Please refer to the chart below for brochures.

Brochure Number	Brochure Name
MB-0297-*	DX07 SMT Contact Receptacle
MB-0335-*	DX07 Hybrid Contact Receptacle
MB-0336-*	DX07 Vertical Receptacle
MB-0301-*	DX07 Plug Series
MB-0322-*	DX07 Vertical Plug
MB-0324-*	DX07 Harness

Note: The asterisk (\*) stands for revision number.

**General Specifications**

Number of Contacts	24 positions
Contact Resistance	40mΩ max. (initial)
Dielectric Withstanding Voltage	100Vrms / 1 minute
Insulation Resistance	100MΩ (initial)
Mating Durability	10,000 times
Operating Temperature	-30 °C ~ +80 °C

Rated Current	V <sub>BUS</sub> (Terminal No. A4, A9, B4, B9) DC 5A (Total)
	GND (Terminal No. A1, A12, B1, B12) DC 6.25A (Total)
	V <sub>CONN</sub> (Terminal No. B5) DC 1.25A
	Others are DC 0.25A/pin
Rated Voltage	20Vrms

**Waterproof Performance**

Part Number	Waterproof Rating	
DX07W024JA1	IPX8	Protection from submersion of 1.5m depth for 30 minutes
DX07W024JA2		
DX07WH24JA3	IPX7	Protection from submersion of 1.0m depth for 30 minutes

**Ordering Information**

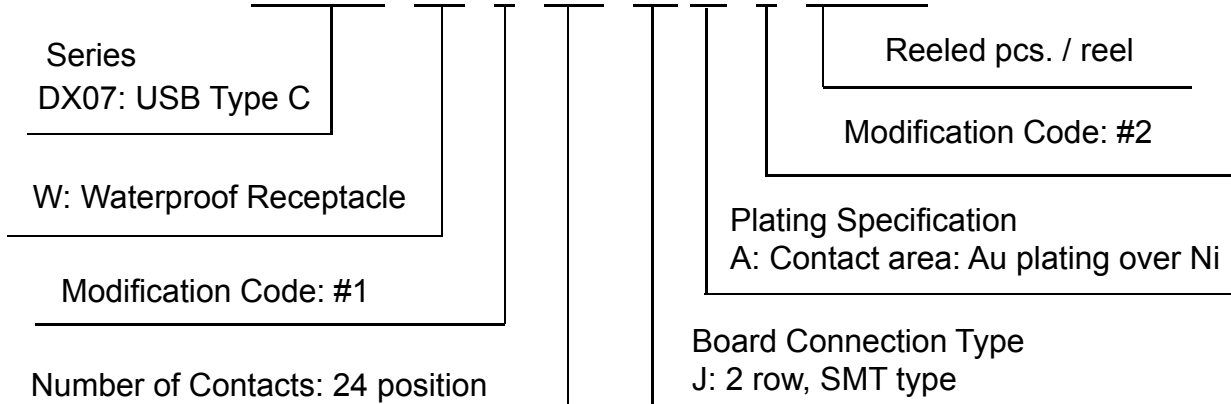

**DX07 W \* 24 J A \* R\*\*\*\***

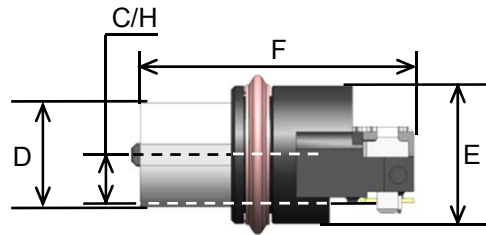
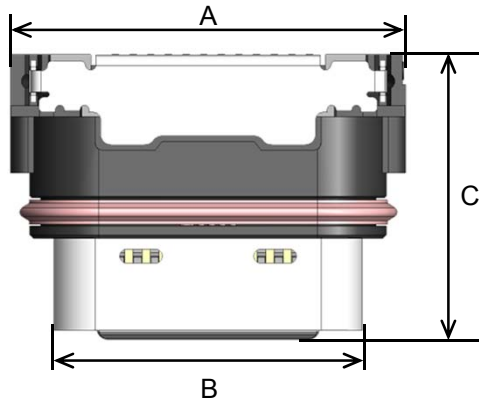

Outer Dimensions

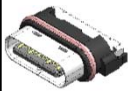

Unit: mm

Part Number		C/H	Dimension A	Dimension B	Dimension C	Dimension D	Dimension E	Dimension F	Mating Length
DX07W024JA1		1.35	11.2	8.74	8.05	2.94	3.9	7.8	4.2
DX07W024JA2								6.2	2.6

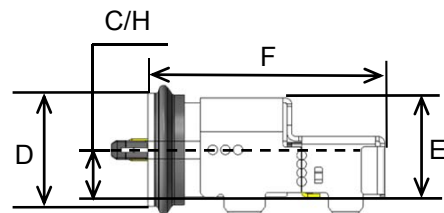
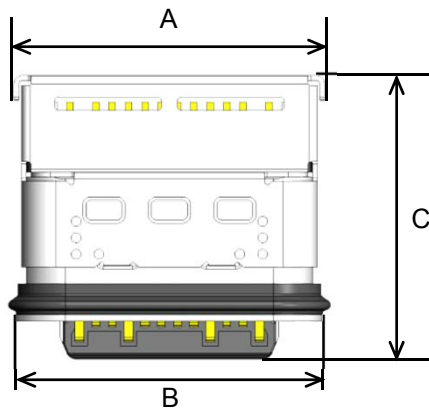

Unit: mm

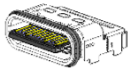
Part Number		C/H	Dimension A	Dimension B	Dimension C	Dimension D	Dimension E	Dimension F	Mating Length
DX07WH24JA3		1.5	9.5	9.35	8.65	3.56	3.13	7.50	3.3

Technical Documents
---------------------

Part Number	Drawing Number	Specifications	Handling Instructions	Reel Packaging Amount
DX07W024JA1 DX07W024JA1R1000	SJ119582 SJ119583	JACS-30398	JAHL-30398	1,000
DX07W024JA2 DX07W024JA2R1000	SJ119766 SJ119767			1,000
DX07WH24JA3 DX07WH24JA3R1200	SJ120981 SJ120982	JACS-30353-24	---	1,200

**Notice:**

1. The values specified in this brochure are only for reference. The products and their specifications are subject to change without notice. Contact our sales staff for further information before considering or ordering any of our products. For purchase, a product specification must be agreed upon.

2. Users are requested to provide protection circuits and redundancy circuits to ensure safety of the equipment, and sufficiently review the suitability of JAE's products to the equipment.

3. The products presented in this brochure are designed for the uses recommended below. We strongly suggest you contact our sales staff when considering use of any of the products in any other way than the recommended applications or for a specific use that requires an extremely high reliability.

(1) Applications that require consultation:

(i) Please contact us if you are considering use involving a quality assurance program that you specify or that is peculiar to the industry, such as:

Automotive electrical components, train control, telecommunications devices (mainline), traffic light control, electric power, combustion control, fire prevention or security systems, disaster prevention equipment, etc.

(ii) We may separately give you our support with a quality assurance program that you specify, when you think of a use such as :

Aviation or space equipment, submarine repeaters, nuclear power control systems, medical equipment for life support, etc.

(2) Recommended applications include:

Computers, office appliances, telecommunications devices (terminals, mobile units), measuring equipment, audiovisual equipment, home electric appliances, factory automation equipment, etc.

**Japan Aviation Electronics Industry, Limited**

Product Marketing Division

Aobadai Building, 3-1-19, Aobadai, Meguro-ku, Tokyo 153-8539

Phone: +81-3-3780-2882 FAX: +81-3-3780-2946

\* The specifications in this brochure are subject to change without notice. Please contact JAE for information.

# Mouser Electronics

Authorized Distributor

Click to View Pricing, Inventory, Delivery & Lifecycle Information:

[JAE Electronics:](#)

[DX07W024JA1R1000](#)