

## 7 inch Wide Screen, TFT Color LCD Type Graphic Touch Panel GP-S070

### ■ Features

- Adopts 7 inch wide TFT LCD for realizing True Color with 16,777,216 colors
- Analog touch method
  - : Free tag arrangement
- Data logger function
  - : Supports data gathering and backup of controller
- Supports variable image library
- Enables to monitor multi stations and multi channels at the same time
- Supports several interface
  - : Supports USB Host/Device to high speed download and manage files
  - : Easy to connect various external devices with RS232C 2 ports and RS232C/RS422 multi-communication port
- Supports several fonts: Supports window true type and several bitmap fonts (selectable)
- Device monitoring function
  - : Enables to monitor/control variable of connected control through communication port
- Easy S/W upgrade available on website
  - (1) GP firmware file
  - (2) GP Editor (drawing program)
  - (3) Additional protocol
  - (4) Language and font, etc
- Connects printer/barcode reader: Enables to print out alarm history, to read barcode



7 inch TFT Color LCD

 Please read "Safety Considerations" in instruction manual before using.



### ■ Manual

For the detail information and instructions, please refer to user manual and user manual for communication, and be sure to follow cautions written in the technical descriptions (catalog, homepage). Visit our homepage ([www.autonics.com](http://www.autonics.com)) to download manuals.

- **GP Editor user manual**  
It describes how to write screen data, and is about related usage of GP-S070 HMI function.
- **GP, LP user manual for communication**  
It describes connection for external devices such as PLC.
- **GP-S070 user manual**  
It describes general information of the installation and usage of GP-S070 and system contents.

### ■ Ordering Information

Model	Item	Series	Monitor size	Display unit	Color	Power supply	Interface
GP-S070-T9D6	Graphic panel	S series	7 inch	TFT Color LCD	16,777,216 color	24VDC	RS232C, RS422, USB HOST, USB DEVICE, Ethernet
GP-S070-T9D7							RS232C (2), USB HOST, USB DEVICE, Ethernet

- (A) Photoelectric Sensors
- (B) Fiber Optic Sensors
- (C) Door/Area Sensors
- (D) Proximity Sensors
- (E) Pressure Sensors
- (F) Rotary Encoders
- (G) Connectors/ Connector Cables/ Sensor Distribution Boxes/ Sockets
- (H) Temperature Controllers
- (I) SSRs / Power Controllers
- (J) Counters
- (K) Timers
- (L) Panel Meters
- (M) Tacho / Speed / Pulse Meters
- (N) Display Units
- (O) Sensor Controllers
- (P) Switching Mode Power Supplies
- (Q) Stepper Motors & Drivers & Controllers
- (R) Graphic/ Logic Panels
- (S) Field Network Devices
- (T) Software

## ■ Specifications

Model	<b>GP-S070-T9D6</b>	<b>GP-S070-T9D7</b>
Power supply	24VDC---	
Allowable voltage range	90 to 110% of power supply	
Power consumption	Max. 7.2W	
Display performance	LCD type	7 inch TFT Color LCD
	Resolution	800×480 dots
	Display area	152.4×91.44mm
	Color	16,777,216 color
	LCD view angle	Within each 60°/ 45°/ 60°/ 60° of top/bottom/left/right
	Backlight	White LED
	Brightness	Adjustable by software
Graphic drawing performance	Language※1	English, Korean
	Text	• Vector font      • 6×8, 8×8 ASCII character, high definition numbers • 8×16 ASCII characters, 16×16 character by each country (1 to 8 times bigger for width, 0.5 to 5 times bigger for height)
	Graphic drawing memory	16MB
	Number of user screen	500 pages
	Touch switch	Analog touch
Serial interface	Asynchronous method: each port of RS232C, RS422 Each port of RS232C, RS422      Two ports of RS232C	
USB interface	Each of USB HOST, USB Device (Version 1.1)	
Ethernet interface	IEEE802.3 (U), 10/100Base-T	
Real-time controller	RTC embedded	
Battery life cycle	Approx. 3 years at 25°C	
Insulation resistance	Over 100MΩ (at 500VDC megger)	
Ground	3rd grounding (max. 100Ω)	
Noise immunity	± 0.5kV the square wave noise (pulse width: 1μs) by the noise simulator	
Withstanding voltage	500VAC 50/60Hz for 1 min	
Vibration	Mechanical	0.75mm amplitude at frequency of 10 to 55Hz (for 1 min) in each X, Y, Z direction for 1 hour
	Malfunction	0.5mm amplitude at frequency of 10 to 55Hz (for 1 min) in each X, Y, Z direction for 10 min
Shock	Mechanical	300m/s <sup>2</sup> (approx. 30G) in each X, Y, Z direction for 3 times
	Malfunction	100m/s <sup>2</sup> (approx. 10G) in each X, Y, Z direction for 3 times
Environ-ment	Ambient temperature	0 to 50°C, storage: -20 to 60°C
	Ambient humidity	35 to 85% RH, storage: 35 to 85%RH
Protection structure	IP65 (front panel, IEC standard)	
Accessory	Fixing bracket: 4, battery (included)	
Approval	CE 	
Weight※2	Approx. 680g (approx. 500g)	

※1: Supported language can be added.

※2: The weight includes packaging. The weight in parenthesis is for unit only.

※Environment resistance is rated at no freezing or condensation.

## ■ Functional Description

Figure display	Line, rectangle, circle, text, bitmap	
Tags	Numeral display	Displays the designated device as numerical value. (decimal, hexadecimal, octal, binary, real number)
	ASCII display	Displays the designated device value as ASCII character.
	Time display	Displays current time or date.
	Alarm history	Registers alarm history.
	Alarm list	Displays generated (not backed up) alarm.
	Comment display	Displays the designated comment as device status or value.
	Lamp	Displays lamp as device status.
	Part display	Displays the designated parts as device status and value.
	Line graph	Displays several device values with a graph of broken line.
	Trend graph	Displays change of device value for time with a graph of broken line.
	Bar graph	Displays a device value with a bar graph.
	Statistic graph	Displays a ratio of several device values with pie graph.
	Panel meter	Displays a device value as panel meter.
	Touch key	Screen is switched, word/bit device values are set when it touched.
Numeral input	Configures user input value in device.	
ASCII input	Configures user input ASCII code value in device.	
System information function	Monitors/Controls GP operation from PLC.	
Recipe function	Reads/Writes several PLC device collectively.	
Security function	Only acceptable user can observe/operate important data.	
Barcode read function	Connects barcode reader, read barcode.	
Floating alarm function	Warning message is floated when alarm is generated.	
Time operation	Specific bit device is ON/OFF for designated day and time.	
Overlap window	Available to form dynamically overlapping another base screen on the base one.	
Observe status function	Changes PLC device status/value of PLC when trigger is generated.	

# Graphic Panel

## ■ Dimensions

(unit: mm)

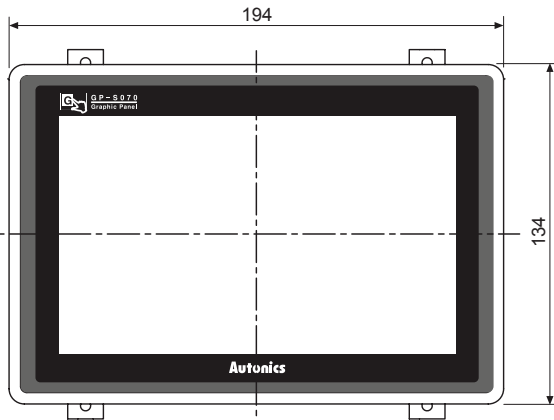
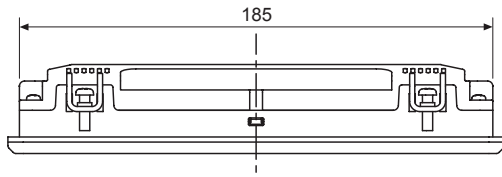

### ● Panel cut-out

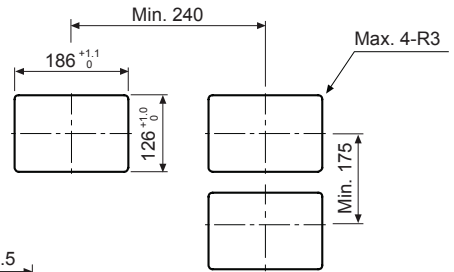

※Panel thickness : max. 4mm

### ● Fixing bracket

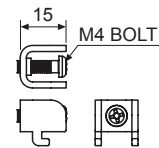

## ■ Unit Description

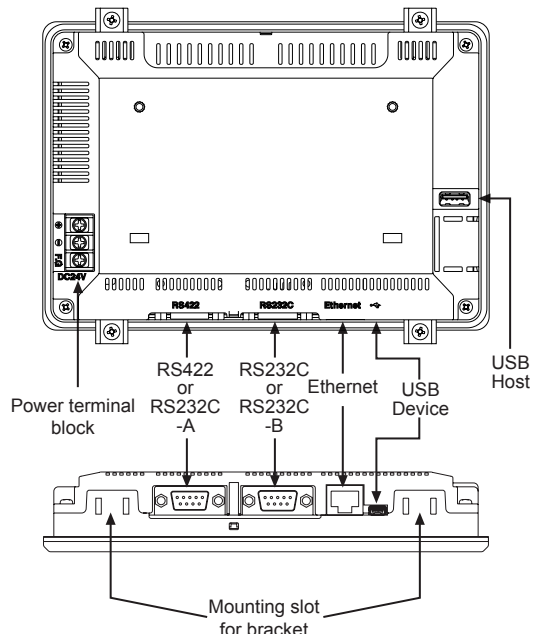
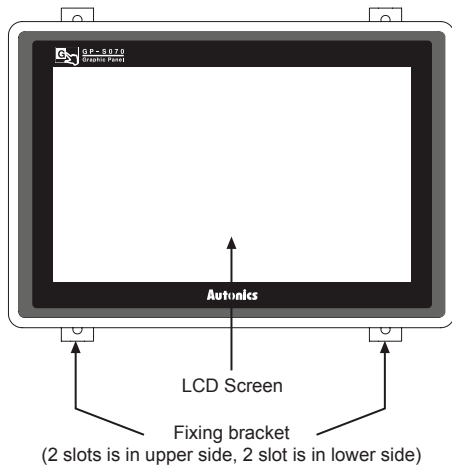

- Ethernet Port: For connecting LAN cable and hub, use direct cable, and for connecting PC directly, use cross cable.
- USB Device: When setting USB Device mode to HID mode in serial setting, it is for uploading/downloading GP Editor project. When setting to Storage mode, it is for transferring/coping data between PC and GP-S070 with recognition as a storage device by PC.  
For details, please refer to 'GP-S070 user manual'.
- USB Host: It is for transferring/coping data between USB storage device and GP-S070 and upgrading firmware.
- RS232C, RS422 ports: For more information, refer to 'Serial Interface' of GP/LP Common Features.

(A)	Photoelectric Sensors
(B)	Fiber Optic Sensors
(C)	Door/Area Sensors
(D)	Proximity Sensors
(E)	Pressure Sensors
(F)	Rotary Encoders
(G)	Connectors/ Connector Cables/ Sensor Distribution Boxes/ Sockets
(H)	Temperature Controllers
(I)	SSRs / Power Controllers
(J)	Counters
(K)	Timers
(L)	Panel Meters
(M)	Tacho / Speed / Pulse Meters
(N)	Display Units
(O)	Sensor Controllers
(P)	Switching Mode Power Supplies
(Q)	Stepper Motors & Drivers & Controllers
(R)	Graphic/ Logic Panels
(S)	Field Network Devices
(T)	Software

# GP-S070

---

## ■ Installation

1. Set GP-S070 in panel.
2. Set fixing brackets in 4 slots (2 slots is in upper side, 2 slots is in lower side).

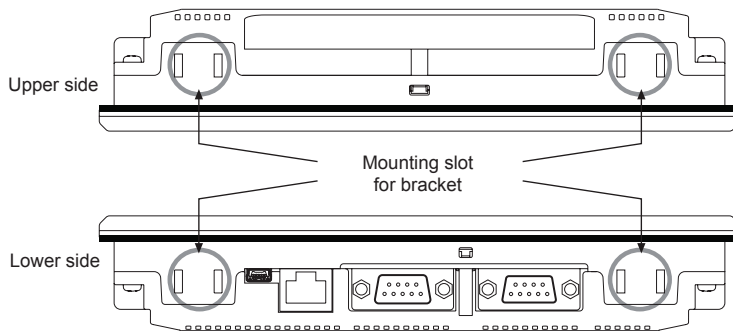

3. Tighten fixing bracket with M4 Screw driver and tightening torque is 0.3 to 0.5N·m.

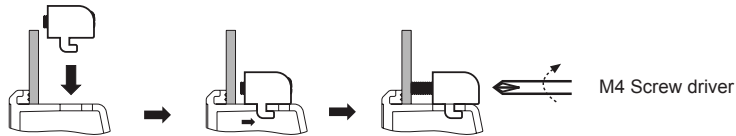

---

## ■ Cable (sold separately)

Serial connection cables which connect GP/LP with PLC or other external devices are sold separately. Refer to "GP/LP Communication Cables".