

## TPS2105-EP $V_{AUX}$ Power-Distribution Switch

### 1 Features

- Dual-Input, Single-Output MOSFET Switch With No Reverse Current Flow (No Parasitic Diodes)
- IN1: 250-m $\Omega$ , 500-mA N-Channel; 18- $\mu$ A Supply Current
- IN2: 1.3-m $\Omega$ , 100-mA P-Channel; 0.75- $\mu$ A Supply Current ( $V_{AUX}$  Mode)
- Advanced Switch Control Logic
- CMOS and TTL Compatible Enable Input
- Controlled Rise, Fall, and Transition Times
- 2.7-V to 5.5-V Operating Range
- SOT-23-5 Package
- 2-kV Human Body Model, 750-V Charged Device Model, 200-V Machine-Model ESD Protection
- Supports Defense, Aerospace, and Medical Applications
  - Controlled Baseline
  - One Assembly and Test Site
  - One Fabrication Site
  - Available in Military (–55°C to 125°C) Temperature Range
  - Extended Product Life Cycle
  - Extended Product-Change Notification
  - Product Traceability

### 2 Applications

- Notebook and Desktop PCs
- Cell phone, Palmtops, and PDAs
- Battery Management

### 3 Description

The TPS2105 is a dual-input, single-output power switch designed to provide uninterrupted output voltage when transitioning between two independent power supplies. Both devices combine one N-channel (250 m $\Omega$ ) and one P-channel (1.3- $\Omega$ ) MOSFET with a single output. The P-channel MOSFET (IN2) is used with auxiliary power supplies that deliver lower current for standby modes. The N-channel MOSFET (IN1) is used with a main power supply that delivers higher current required for normal operation. Low on-resistance makes the N-channel the ideal path for higher main supply current when power-supply regulation and system voltage drops are critical. When using the P-channel MOSFET, quiescent current is reduced to 0.75  $\mu$ A to decrease the demand on the standby power supply. The MOSFETs in the TPS2105 do not have the parasitic diodes, typically found in discrete MOSFETs, thereby preventing back-flow current when the switch is off.

#### Device Information<sup>(1)</sup>

ORDER NUMBER	PACKAGE	BODY SIZE (NOM)
TPS2105MDBVREP	SOT-23 (5)	2.90 mm x 1.60 mm

(1) For all available packages, see the orderable addendum at the end of the data sheet.

#### Simplified Schematic

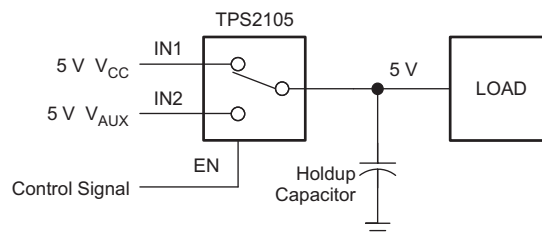

## Table of Contents

<b>1 Features</b> .....	<a href="#">1</a>	7.2 Functional Block Diagram .....	<a href="#">9</a>
<b>2 Applications</b> .....	<a href="#">1</a>	7.3 Feature Description .....	<a href="#">9</a>
<b>3 Description</b> .....	<a href="#">1</a>	7.4 Device Functional Modes .....	<a href="#">10</a>
<b>4 Revision History</b> .....	<a href="#">2</a>	<b>8 Application and Implementation</b> .....	<a href="#">11</a>
<b>5 Pin Configuration and Functions</b> .....	<a href="#">3</a>	8.1 Application Information .....	<a href="#">11</a>
<b>6 Specifications</b> .....	<a href="#">4</a>	8.2 Typical Application .....	<a href="#">11</a>
6.1 Absolute Maximum Ratings .....	<a href="#">4</a>	<b>9 Power Supply Recommendations</b> .....	<a href="#">14</a>
6.2 Handling Ratings .....	<a href="#">4</a>	<b>10 Layout</b> .....	<a href="#">14</a>
6.3 Recommended Operating Conditions .....	<a href="#">4</a>	10.1 Layout Guidelines .....	<a href="#">14</a>
6.4 Thermal Information .....	<a href="#">4</a>	10.2 Layout Examples .....	<a href="#">15</a>
6.5 Electrical Characteristics .....	<a href="#">5</a>	<b>11 Device and Documentation Support</b> .....	<a href="#">17</a>
6.6 Switching Characteristics .....	<a href="#">6</a>	11.1 Trademarks .....	<a href="#">17</a>
6.7 Typical Characteristics .....	<a href="#">7</a>	11.2 Electrostatic Discharge Caution .....	<a href="#">17</a>
<b>7 Detailed Description</b> .....	<a href="#">9</a>	11.3 Glossary .....	<a href="#">17</a>
7.1 Overview .....	<a href="#">9</a>	<b>12 Mechanical, Packaging, and Orderable Information</b> .....	<a href="#">17</a>

## 4 Revision History

DATE	VERSION	NOTES
July 2014	*	Initial Release

## 5 Pin Configuration and Functions

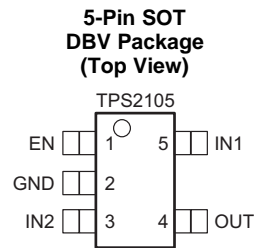

### Pin Functions

PIN		I/O	DESCRIPTION
NAME	NO.		
EN	1	I	Active-high enable for IN1-OUT switch
GND	2	I	Ground
IN1 <sup>(1)</sup>	5	I	Main input voltage, NMOS drain (250 mΩ), requires 0.22-μF bypass
IN2 <sup>(1)</sup>	3	I	Auxiliary input voltage, PMOS drain (1.3 Ω), requires 0.22-μF bypass
OUT	4	O	Power switch output

(1) Unused INx should not be grounded.

**Table 1. Function Table**

TPS2105			
VIN1	VIN2	EN	OUT
0 V	0 V	XX <sup>(1)</sup>	GND
0 V	5 V	h	GND
5 V	0 V	h	VIN1
5 V	5 V	h	VIN1
0 V	5 V	l	VIN2
5 V	0 V	l	VIN2
5 V	5 V	l	VIN2

(1) XX = Don't care

## 6 Specifications

### 6.1 Absolute Maximum Ratings

over operating free-air temperature range (unless otherwise noted)<sup>(1)</sup>

		MIN	MAX	UNIT
$V_{I(IN1)}$	Input voltage <sup>(2)</sup>	-0.3	6	V
$V_{I(IN2)}$	Input voltage <sup>(2)</sup>	-0.3	6	V
	Input voltage, $V_I$ at EN <sup>(2)</sup>	-0.3	6	V
$V_O$	Output voltage <sup>(2)</sup>	-0.3	6	V
$I_{O(IN1)}$	Continuous output current		700	mA
$I_{O(IN2)}$	Continuous output current		140	mA
	Continuous total power dissipation	See <a href="#">Thermal Information</a>		
$T_J$	Operating virtual junction temperature	-55	150	°C
	Lead temperature soldering 1.6 mm (1/16 inch) from case for 10 s		260	°C

- (1) Stresses beyond those listed under *Absolute Maximum Ratings* may cause permanent damage to the device. These are stress ratings only, and functional operation of the device at these or any other conditions beyond those indicated under *Recommended Operating Conditions* is not implied. Exposure to absolute-maximum-rated conditions for extended periods may affect device reliability.
- (2) All voltages are with respect to GND.

### 6.2 Handling Ratings

		MIN	MAX	UNIT	
$T_{stg}$	Storage temperature range	-65	150	°C	
$V_{(ESD)}$	Electrostatic discharge	Human body model (HBM), per ANSI/ESDA/JEDEC JS-001, all pins <sup>(1)</sup>	-2000	2000	V
		Machine model (MM) ESD stress voltage	-200	200	
		Charged device model (CDM), per JEDEC specification JESD22-C101, all pins <sup>(2)</sup>	-750	750	

- (1) JEDEC document JEP155 states that 500-V HBM allows safe manufacturing with a standard ESD control process.
- (2) JEDEC document JEP157 states that 250-V CDM allows safe manufacturing with a standard ESD control process.

### 6.3 Recommended Operating Conditions

over operating free-air temperature range (unless otherwise noted)

		MIN	MAX	UNIT
$V_{I(INx)}$	Input voltage	2.7	5.5	V
	Input voltage, $V_I$ at EN	0	5.5	V
$I_{O(IN1)}$	Continuous output current		500	mA
$I_{O(IN2)}$	Continuous output current		100 <sup>(1)</sup>	mA
$T_J$	Operating virtual junction temperature	-55	125	°C

- (1) The device can deliver up to 220 mA at  $I_{O(IN2)}$ . However, operation at the higher current levels results in greater voltage drop across the device, and greater voltage droop when switching between IN1 and IN2.

### 6.4 Thermal Information

THERMAL METRIC <sup>(1)</sup>		TPS2105-EP	UNIT
		DBV (5 PINS)	
$R_{\theta JA}$	Junction-to-ambient thermal resistance	208.7	°C/W
$R_{\theta JC(top)}$	Junction-to-case (top) thermal resistance	122.9	
$R_{\theta JB}$	Junction-to-board thermal resistance	36.7	
$\Psi_{JT}$	Junction-to-top characterization parameter	14.2	
$\Psi_{JB}$	Junction-to-board characterization parameter	35.8	
$R_{\theta JC(bot)}$	Junction-to-case (bottom) thermal resistance	N/A	

- (1) For more information about traditional and new thermal metrics, see the IC Package Thermal Metrics application report, [SPRA953](#).

### 6.5 Electrical Characteristics

Over recommended operating range (unless otherwise specified)

PARAMETER	TEST CONDITIONS	MIN	TYP	MAX	UNIT
<b>POWER SWITCH</b>					
$r_{DS(on)}$ On-state resistance	IN1-OUT, $V_{I(IN1)} = 5.5\text{ V}$ , $V_{I(IN2)} = 0\text{ V}$		250	435	m $\Omega$
	IN2-OUT, $V_{I(IN2)} = 5.5\text{ V}$ , $V_{I(IN1)} = 0\text{ V}$		1.3	2.4	$\Omega$
<b>ENABLE INPUT</b>					
$V_{IH}$ High-level input voltage	$2.7\text{ V} \leq V_{I(INx)} \leq 5.5\text{ V}$	2			V
$V_{IL}$ Low-level input voltage	$2.7\text{ V} \leq V_{I(INx)} \leq 5.5\text{ V}$			0.8	V
$I_I$ Input current	EN = 0 V or EN = $V_{I(INx)}$	-0.65		0.65	$\mu\text{A}$
<b>SUPPLY CURRENT</b>					
$I_I$ Supply current	EN = L, IN2 selected		0.75	1.5	$\mu\text{A}$
	EN = H, IN1 selected		18	35	$\mu\text{A}$

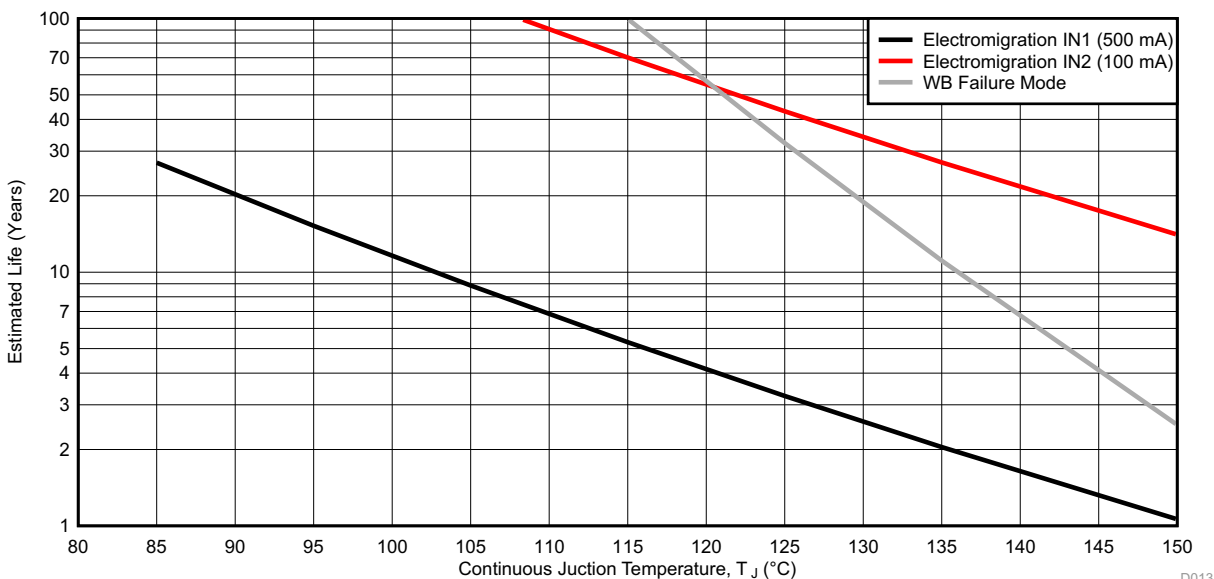

- (1) Wirebond life = Time at temperature with or without bias
- (2) Electromigration fail mode = Time at temperature with bias
- (3) Silicon operating life design goal is 10 years at 105°C junction temperature (does not include package interconnect life).
- (4) The predicted operating lifetime versus junction temperature is based on reliability modeling and available qualification data.

**Figure 1. Predicted Lifetime Derating Chart for TPS2105-EP**

### 6.6 Switching Characteristics

$T_J = 25^\circ\text{C}$ ,  $V_{I(IN1)} = V_{I(IN2)} = 5\text{ V}$  (unless otherwise noted)

PARAMETER		TEST CONDITIONS		MIN	TYP	MAX	UNIT
$t_r$	Output rise time	IN1-OUT	$V_{I(IN2)} = 0$	$C_L = 1\ \mu\text{F}, I_L = 500\ \text{mA}$	340		$\mu\text{s}$
				$C_L = 10\ \mu\text{F}, I_L = 500\ \text{mA}$	340		
				$C_L = 1\ \mu\text{F}, I_L = 100\ \text{mA}$	312		
		IN2-OUT	$V_{I(IN1)} = 0$	$C_L = 1\ \mu\text{F}, I_L = 100\ \text{mA}$	3.4		
				$C_L = 10\ \mu\text{F}, I_L = 100\ \text{mA}$	34		
				$C_L = 1\ \mu\text{F}, I_L = 10\ \text{mA}$	3.5		
$t_f$	Output fall time	IN1-OUT	$V_{I(IN2)} = 0$	$C_L = 1\ \mu\text{F}, I_L = 500\ \text{mA}$	6		$\mu\text{s}$
				$C_L = 10\ \mu\text{F}, I_L = 500\ \text{mA}$	108		
				$C_L = 1\ \mu\text{F}, I_L = 100\ \text{mA}$	8		
		IN2-OUT	$V_{I(IN1)} = 0$	$C_L = 1\ \mu\text{F}, I_L = 100\ \text{mA}$	100		
				$C_L = 10\ \mu\text{F}, I_L = 100\ \text{mA}$	990		
				$C_L = 1\ \mu\text{F}, I_L = 10\ \text{mA}$	1000		
$t_{PLH}$	Propagation delay time, low-to-high output	IN1-OUT	$V_{I(IN2)} = 0$	55		$\mu\text{s}$	
		IN2-OUT	$V_{I(IN1)} = 0$	1			
$t_{PHL}$	Propagation delay time, high-to-low output	IN1-OUT	$V_{I(IN2)} = 0$	1.5		$\mu\text{s}$	
		IN2-OUT	$V_{I(IN1)} = 0$	50			

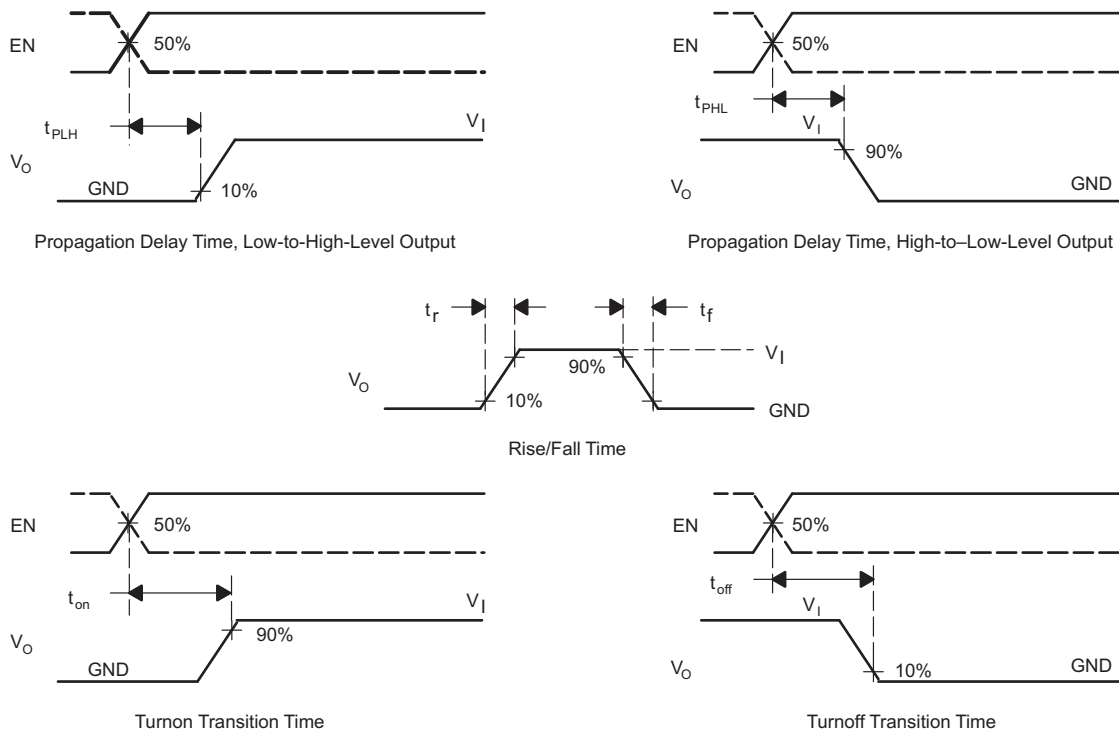
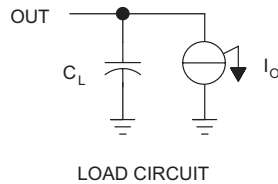

**Figure 2. Test Circuit and Voltage Waveforms**

### 6.7 Typical Characteristics

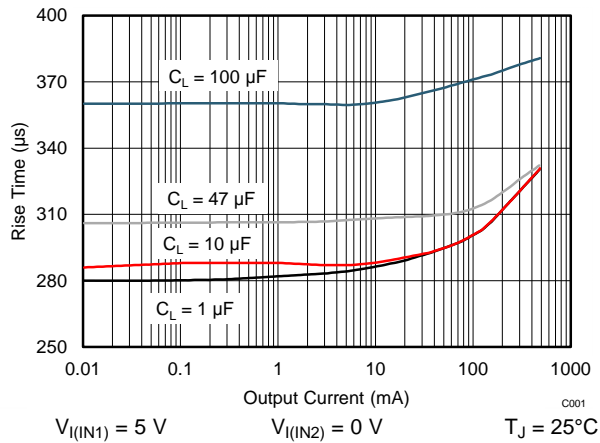

Figure 3. IN1 Switch Rise Time vs Output Current

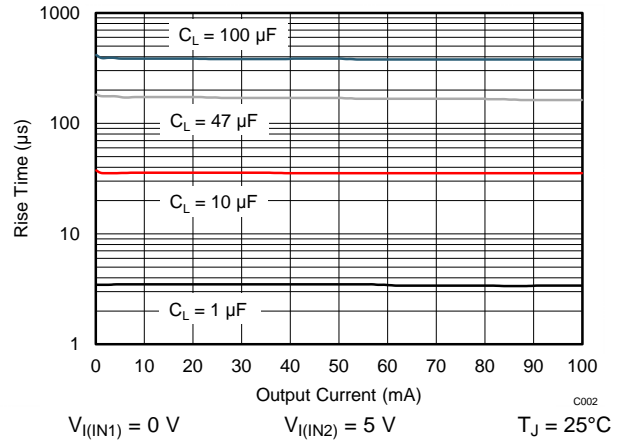

Figure 4. IN2 Switch Rise Time vs Output Current

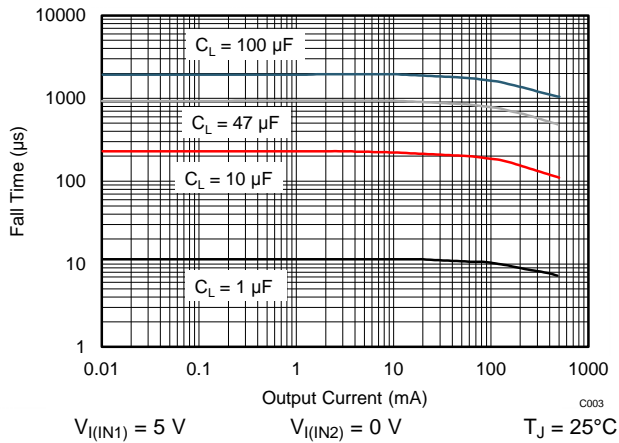

Figure 5. IN1 Switch Fall Time vs Output Current

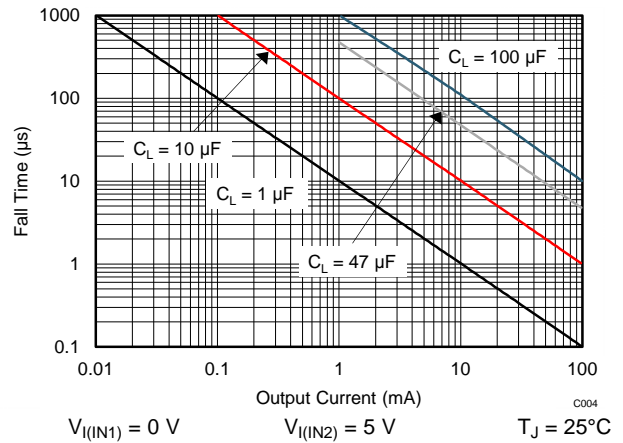
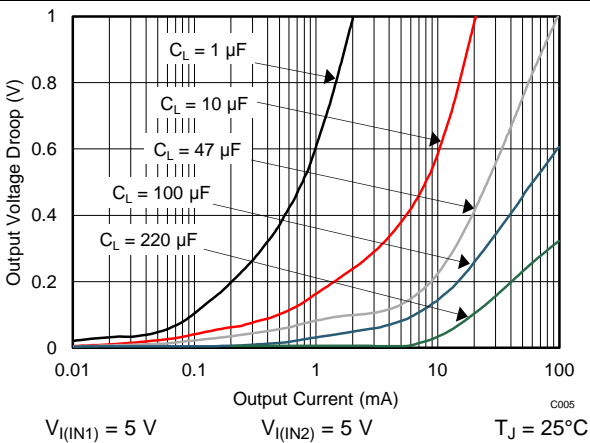

Figure 6. IN2 Switch Fall Time vs Output Current



If switching from IN1 to IN2, the voltage droop is much smaller. Thus, choose the load capacitance according to Figure 6.

Figure 7. Output Voltage Droop vs Output Current When Output is Switched from IN2 to IN1

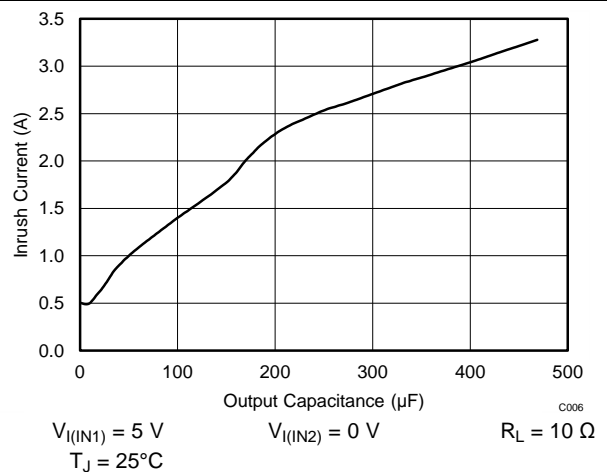

Figure 8. Inrush Current vs Output Capacitance

Typical Characteristics (continued)

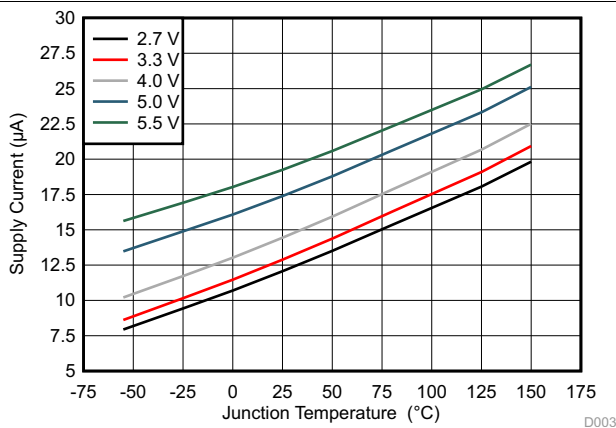

Figure 9. IN1 Supply Current vs Junction Temperature (IN1 Enabled)

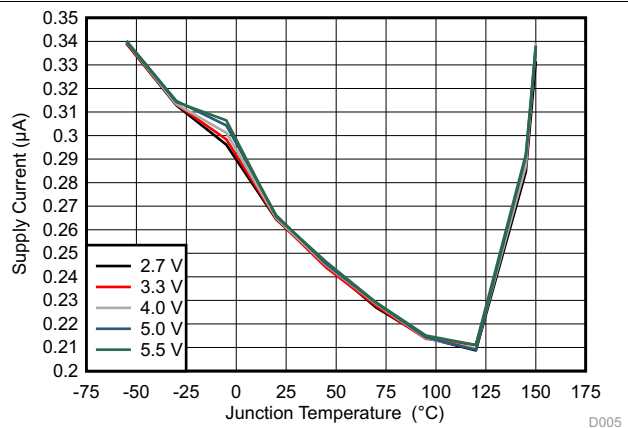

Figure 10. IN1 Supply Current vs Junction Temperature (IN1 Disabled)

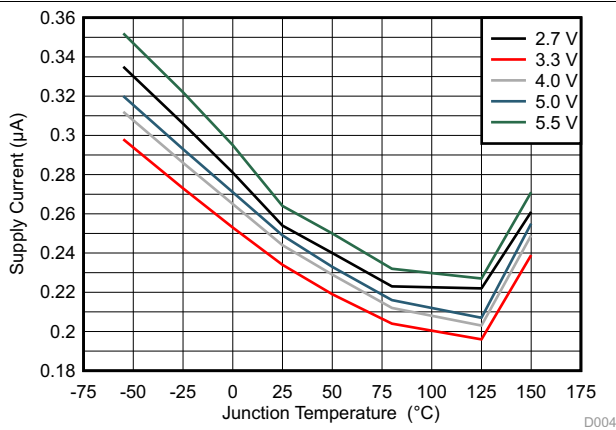

Figure 11. IN2 Supply Current vs Junction Temperature (IN2 Enabled)

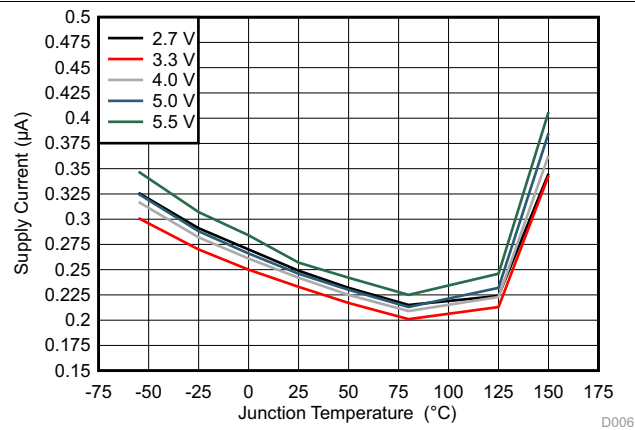

Figure 12. IN2 Supply Current vs Junction Temperature (IN2 Disabled)

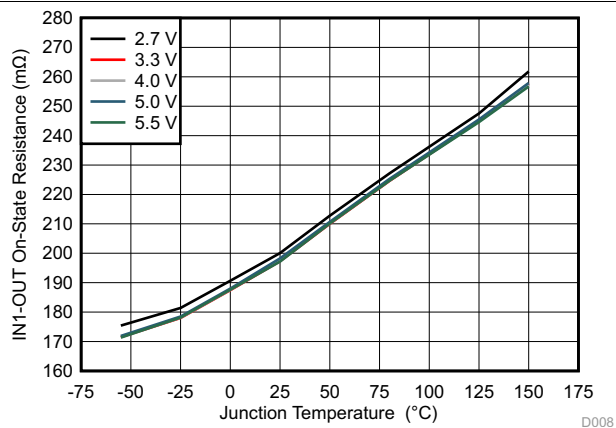

Figure 13. IN1-Out On-State Resistance vs Junction Temperature

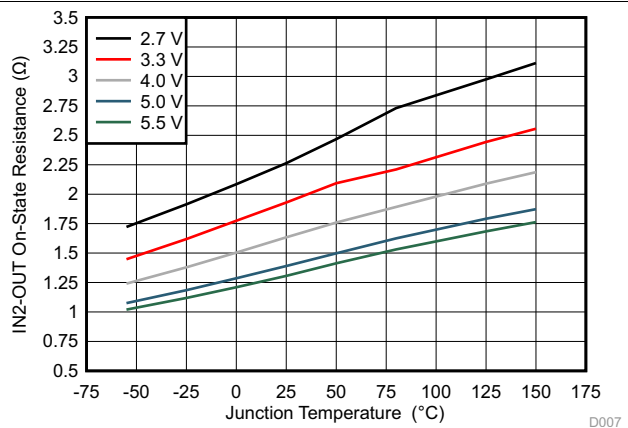

Figure 14. IN2-Out On-State Resistance vs Junction Temperature



## 7 Detailed Description

### 7.1 Overview

The TPS2105 is a dual-input, single-output power switch designed to provide uninterrupted output voltage when transitioning between two independent power supplies.

The device combines one N-channel (250-m) MOSFET with a single output. The P-channel MOSFET (IN2) is used with auxiliary power supplies that deliver lower current for standby modes. The N-channel MOSFET (IN1) is used with a main power supply that delivers higher current required for normal operation.

The low on-resistance makes the N-channel the ideal path for higher main supply current when power-supply regulation and system voltage drops are critical. When using the P-channel MOSFET, quiescent current is reduced to 0.75  $\mu\text{A}$  to decrease the demand on the standby power supply.

The MOSFETs in the device do not have the parasitic diodes, typically found in discrete MOSFETs, thereby preventing back-flow current when the switch is off.

### 7.2 Functional Block Diagram

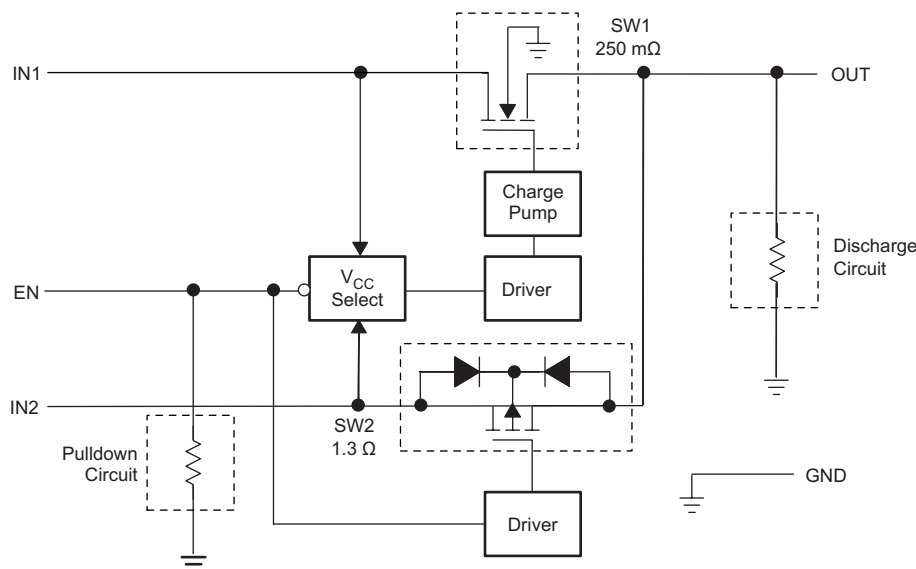

### 7.3 Feature Description

#### 7.3.1 Power Switches

##### 7.3.1.1 N-Channel MOSFET

The IN1-OUT N-channel MOSFET power switch has a typical on-resistance of 250 m $\Omega$  at 5-V input voltage and is configured as a high-side switch.

##### 7.3.1.2 P-Channel MOSFET

The IN2-OUT P-channel MOSFET power switch has a typical on-resistance of 1.3  $\Omega$  at 5-V input voltage and is configured as a high-side switch. When operating, the P-channel MOSFET quiescent current is reduced to typically 0.75  $\mu\text{A}$ .

##### 7.3.1.3 Charge Pump

An internal charge pump supplies power to the driver circuit and provides the necessary voltage to pull the gate of the MOSFET above the source. The charge pump operates from input voltages as low as 2.7 V and requires very little supply current.

## Feature Description (continued)

### 7.3.1.4 Driver

The driver controls the gate voltage of the IN1-OUT and IN2-OUT power switches. To limit large current surges and reduce the associated electromagnetic interference (EMI) produced, the drivers incorporate circuitry that controls the rise times and fall times of the output voltage.

### 7.3.1.5 Enable

The logic enable turns on the IN2-OUT power switch when a logic low is present on EN. A logic high on EN restores bias to the drive and control circuits and turns on the IN1-OUT power switch. The enable input is compatible with both TTL and CMOS logic levels.

## 7.4 Device Functional Modes

### 7.4.1 Operation With EN Control

The logic enable turns on the IN1-OUT power switch when a logic high is present on EN. Also, a logic low present on EN turns off the IN1-OUT and turns on the IN2-OUT power switch.

## 8 Application and Implementation

### 8.1 Application Information

The TPS2105 is a dual-input, single-output power switch designed to provide uninterrupted output voltage when transitioning between two independent power supplies.

### 8.2 Typical Application

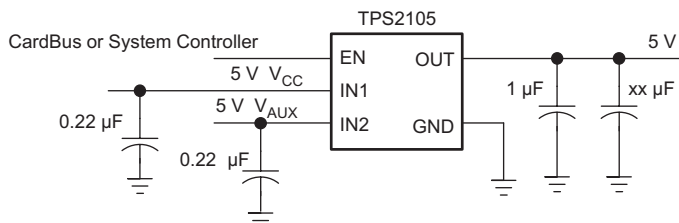

**Figure 15. Typical Application Schematic**

#### 8.2.1 Design Requirements

For this design example, use the following as the input parameters.

**Table 2. Design Parameters**

DESIGN PARAMETER	EXAMPLE VALUE
Input voltage range, $V_{I(IN1)}$	5 V
Input voltage range, $V_{I(IN2)}$	5 V
Output voltage	5 V
Continuous output current, $I_O$	100 mA
Output capacitor, $C_L$	220 $\mu$ F

#### 8.2.2 Detailed Design Procedure

##### 8.2.2.1 Step-by-Step Design Procedure

To begin the design process, the designer must decide upon a few parameters. The designer needs to know the following:

- Input voltage range,  $V_{I(IN1)}$
- Input voltage range,  $V_{I(IN2)}$
- Output voltage
- Continuous output current
- Output capacitance

##### 8.2.2.2 Power-Supply Considerations

TI recommends a 0.22- $\mu$ F ceramic bypass capacitor between IN and GND, close to the device. The output capacitor should be chosen based on the size of the load during the transition of the switch. TI recommends a 220- $\mu$ F capacitor for 100-mA loads. Typical output capacitors (xx  $\mu$ F, shown in Figure 15) required for a given load can be determined from Figure 7, which shows the output voltage droop when output is switched from IN2 to IN1. The output voltage droop is insignificant when output is switched from IN1 to IN2. Additionally, bypassing the output with a 1- $\mu$ F ceramic capacitor improves the immunity of the device to short-circuit transients.

##### 8.2.2.3 Switch Transition

The N-channel MOSFET on IN1 uses a charge pump to create the gate-drive voltage, which gives the IN1 switch a rise time of approximately 0.4 ms. The P-channel MOSFET on IN2 has a simpler drive circuit that allows a rise time of approximately 4  $\mu$ s. Because the device has two switches and a single enable pin, these rise times are seen as transition times, from IN1 to IN2, or IN2 to IN1, by the output. The controlled transition times help limit the surge currents seen by the power supply during switching.

### 8.2.2.4 Thermal Protection

Thermal protection provided on the IN1 switch prevents damage to the IC when heavy-overload or short-circuit faults are present for extended periods of time. The increased dissipation causes the junction temperature to rise to dangerously high levels. The protection circuit senses the junction temperature of the switch and shuts it off at approximately 145°C (T<sub>J</sub>). The switch remains off until the junction temperature has dropped approximately 10°C. The switch continues to cycle in this manner until the load fault or input power is removed.

### 8.2.2.5 Undervoltage Lockout

An undervoltage lockout function is provided to ensure that the power switch is in the off state at power-up. Whenever the input voltage falls below approximately 2 V, the power switch quickly turns off. This function facilitates the design of hot-insertion systems that may not have the capability to turn off the power switch before input power is removed. Upon reinsertion, the power switch is turned on with a controlled rise time to reduce EMI and voltage overshoots.

### 8.2.2.6 Power Dissipation and Junction Temperature

The low on-resistance on the N-channel MOSFET allows small surface-mount packages, such as SOIC, to pass large currents. The thermal resistances of these packages are high compared to those of power packages; it is a good design practice to check power dissipation and junction temperature. First, find r<sub>on</sub> at the input voltage and operating temperature. As an initial estimate, use the highest operating ambient temperature of interest and read r<sub>on</sub> from [Figure 13](#) or [Figure 14](#). Next calculate the power dissipation using:

$$P_D = r_{on} \times I^2 \quad (1)$$

Finally, calculate the junction temperature:

$$T_J = P_D \times R_{\theta JA} + T_A$$

where

- T<sub>A</sub> = Ambient temperature
- R<sub>θJA</sub> = Thermal resistance (2)

Compare the calculated junction temperature with the initial estimate. If they do not agree within a few degrees, repeat the calculation using the calculated value as the new estimate. Two or three iterations are generally sufficient to obtain a reasonable answer.

### 8.2.2.7 ESD Protection

All TPS2105 pins incorporate ESD-protection circuitry designed to withstand a 2-kV human-body-model, 750-V CDM, and 200-V machine-model discharge as defined in MIL-STD-883C.

### 8.2.3 Application Curves

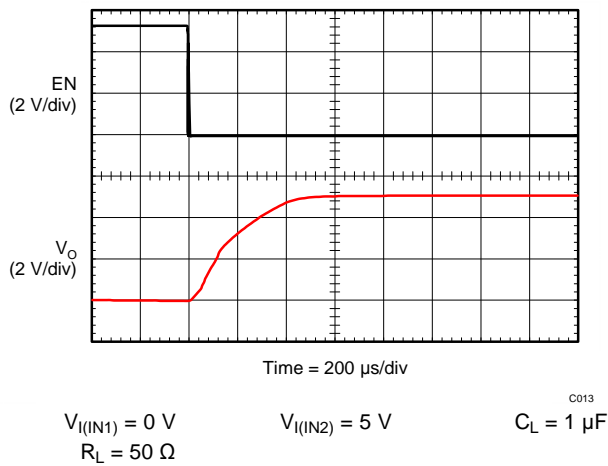

Figure 16. Propagation Delay and Rise Time With 1- $\mu$ F Load, IN2 Turnon

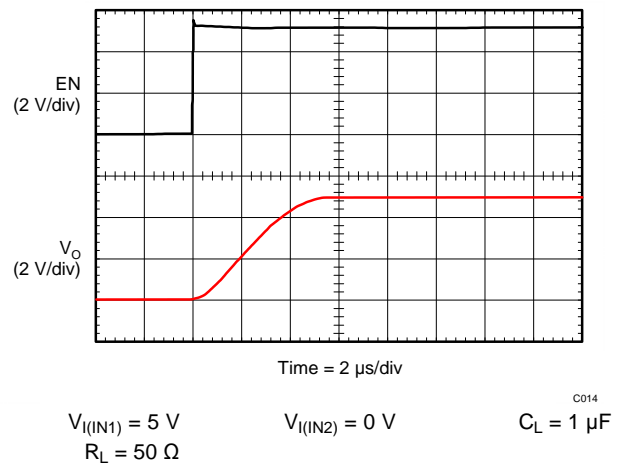

Figure 17. Propagation Delay and Rise Time With 1- $\mu$ F Load, IN1 Turnon

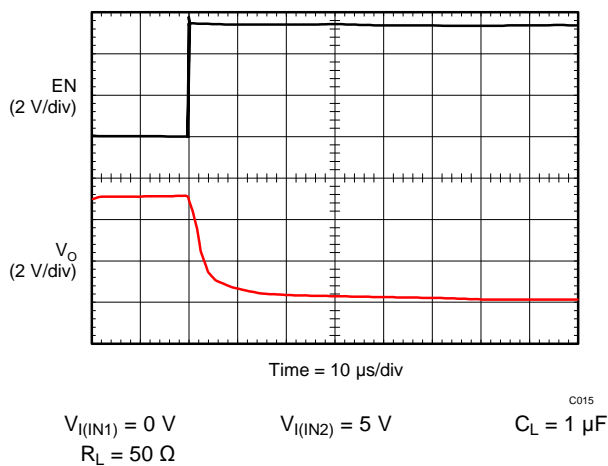

Figure 18. Propagation Delay and Fall Time With 1- $\mu$ F Load, IN2 Turnoff

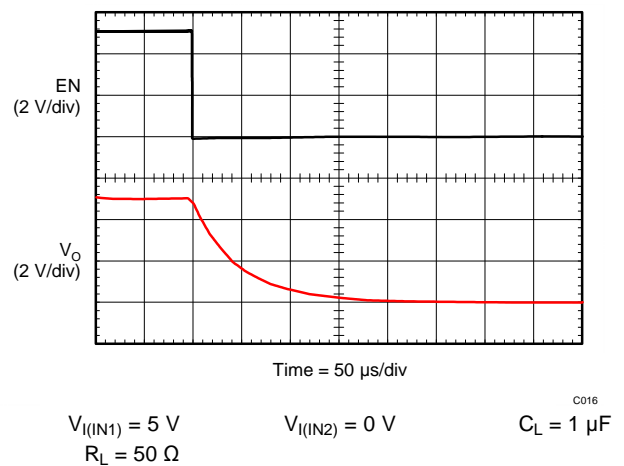

Figure 19. Propagation Delay and Fall Time With 1- $\mu$ F Load, IN1 Turnoff

## 9 Power Supply Recommendations

The device is designed to operate from an input voltage supply range from 2.7 to 5.5 V. A 0.22- $\mu$ F ceramic bypass capacitor is needed between IN and GND; TI recommends placing the capacitor close to the device. The output capacitor should be chosen based on the size of the load during the transition of the switch. TI recommends a 220- $\mu$ F capacitor for 100-mA loads. Adding a 1- $\mu$ F ceramic bypass capacitor at the output can help to improve the immunity of the device to short-circuit transients.

TPS2105-EP requires a high-quality ceramic, type X5R or X7R, input decoupling capacitor. The value of a ceramic capacitor varies significantly over temperature and the amount of DC bias applied to the capacitor. The capacitance variations due to temperature can be minimized by selecting a dielectric material that is stable over temperature. X5R and X7R ceramic dielectrics are usually selected for power regulator capacitors because they have a high capacitance to volume ratio and are fairly stable over temperature. The output capacitor must also be selected with the DC bias taken into account. Ceramic capacitors lose capacitance when a DC bias is applied across the capacitor. This capacitance loss is due to the polarization of the ceramic material. The capacitance loss is not permanent; after a large DC bias is applied, reducing the DC bias reduces the degree of polarization and capacitance increases. The capacitance value of a capacitor decreases as the DC bias across a capacitor increases.

All tantalum capacitors have tantalum (Ta) particles sintered together to form an anode. The cathode material can either be the traditional  $\text{MnO}_2$  or a conductive polymer. Because  $\text{MnO}_2$  is actually a semiconductor, it has a very high amount of resistance associated with it. A characteristic of this material is that as temperature changes, so does its conductivity. So  $\text{MnO}_2$ -based Tantalum capacitors have relatively high ESR and that ESR shifts significantly across the operational temperature range.

However, polymer-based cathodes use a highly-conductive polymer material. Because the material is inherently conductive, tantalum-polymers have a relatively-low ESR compared to their  $\text{MnO}_2$  counterparts in the same voltage and capacitance ranges.

All tantalum capacitors have a voltage derating factor associated with them. Because the polymer material puts less stress on the tantalum-pentoxide dielectric during reflow soldering, more voltage can be applied compared to a  $\text{MnO}_2$ -based tantalum. For polymer-based capacitors, TI recommends 20% derating. Whereas the  $\text{MnO}_2$ -based tantalum capacitors require 50% or higher derating. Refer to the capacitor vendor data sheet for more details regarding the derating guidelines.

## 10 Layout

### 10.1 Layout Guidelines

- The IN1 and OUT pins of the TPS2105-EP can carry up to 500 mA, so trace to these pins should have short length and wider traces to minimize the voltage drop to the load.
- Both the IN1 and IN2 pins should be bypassed to ground with a low-ESR ceramic bypass capacitor. The typical recommended bypass capacitance is 0.22- $\mu$ F ceramic capacitor.
- A bypass capacitor and a load capacitor are needed on the output terminal.
- TI recommends a 220- $\mu$ F output load capacitor for 100-mA loads.
- Locating the 1- $\mu$ F ceramic bypass capacitor at the output can improve the immunity of the device to short-circuit transients.
- The GND terminal should be tied to the PCB ground plane at the terminal of the DUT.

## 10.2 Layout Examples

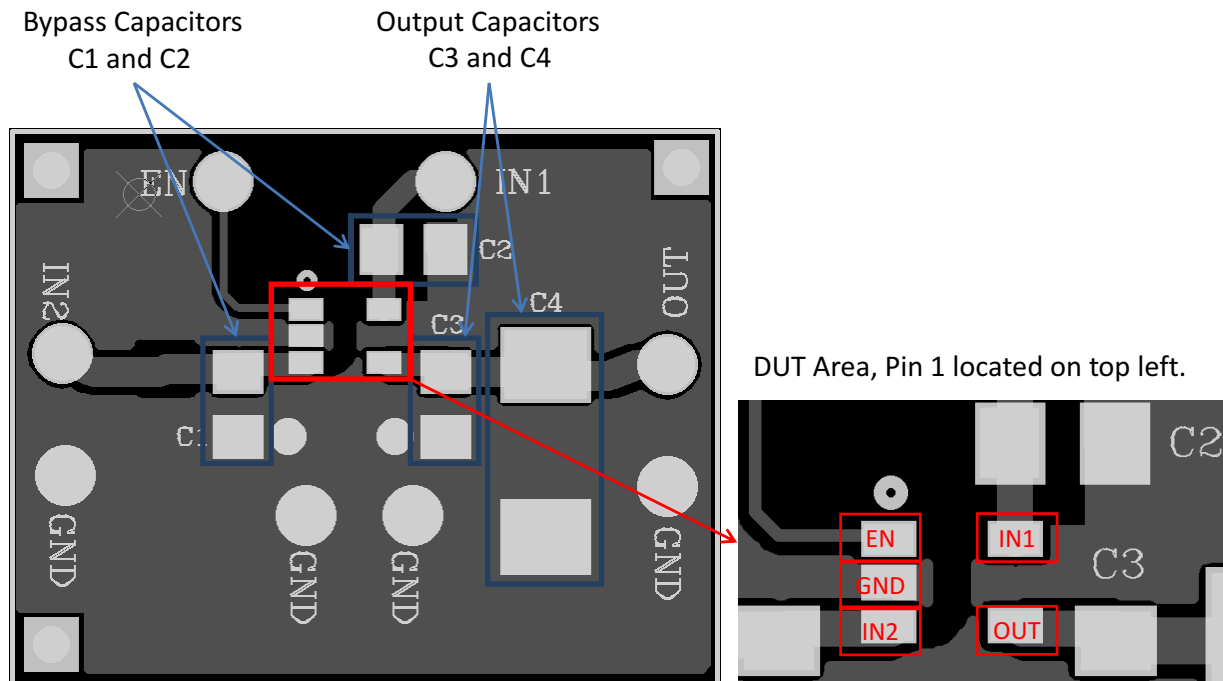

Figure 20. Input and Output Capacitors and DUT Area

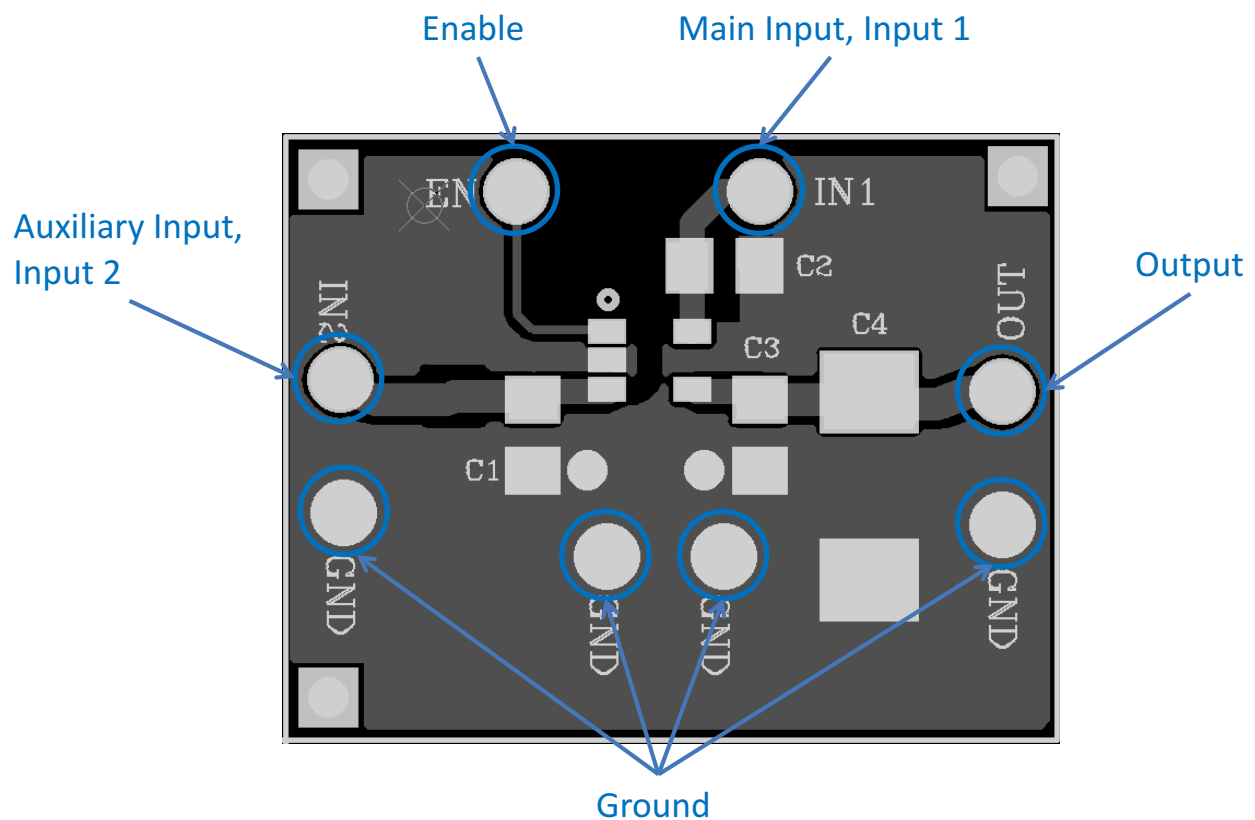
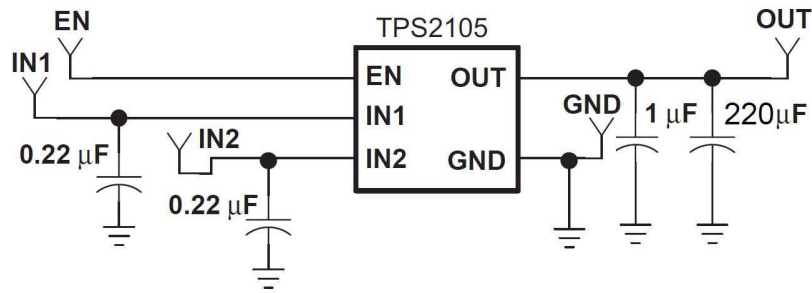

Figure 21. Enable, Input, Output, and Ground Pins

**Layout Examples (continued)**

**Figure 22. Schematics Diagram**
**Table 3. Component Descriptions**

PART	DESCRIPTION
C <sub>1</sub> , C <sub>2</sub>	0.22 μF, size 0805
C <sub>3</sub>	1 μF, size 0805
C <sub>4</sub>	220 μF, tantalum capacitors
U <sub>1</sub>	TPS2105MDBVREP
TP_EN, TP_IN <sub>1</sub> , TP_IN <sub>2</sub> , TP_OUT, TP_GND	Test point, through hole



## 11 Device and Documentation Support

### 11.1 Trademarks

All trademarks are the property of their respective owners.

### 11.2 Electrostatic Discharge Caution



These devices have limited built-in ESD protection. The leads should be shorted together or the device placed in conductive foam during storage or handling to prevent electrostatic damage to the MOS gates.

### 11.3 Glossary

[SLYZ022](#) — *TI Glossary*.

This glossary lists and explains terms, acronyms, and definitions.

## 12 Mechanical, Packaging, and Orderable Information

The following pages include mechanical, packaging, and orderable information. This information is the most current data available for the designated devices. This data is subject to change without notice and revision of this document. For browser-based versions of this data sheet, refer to the left-hand navigation.

**PACKAGING INFORMATION**

Orderable Device	Status (1)	Package Type	Package Drawing	Pins	Package Qty	Eco Plan (2)	Lead finish/ Ball material (6)	MSL Peak Temp (3)	Op Temp (°C)	Device Marking (4/5)	Samples
TPS2105MDBVREP	ACTIVE	SOT-23	DBV	5	3000	RoHS & Green	NIPDAU	Level-1-260C-UNLIM	-55 to 125	PD9M	<a href="#">Samples</a>
V62/14616-01XE	ACTIVE	SOT-23	DBV	5	3000	RoHS & Green	NIPDAU	Level-1-260C-UNLIM	-55 to 125	PD9M	<a href="#">Samples</a>

(1) The marketing status values are defined as follows:

**ACTIVE:** Product device recommended for new designs.

**LIFEBUY:** TI has announced that the device will be discontinued, and a lifetime-buy period is in effect.

**NRND:** Not recommended for new designs. Device is in production to support existing customers, but TI does not recommend using this part in a new design.

**PREVIEW:** Device has been announced but is not in production. Samples may or may not be available.

**OBSOLETE:** TI has discontinued the production of the device.

(2) **RoHS:** TI defines "RoHS" to mean semiconductor products that are compliant with the current EU RoHS requirements for all 10 RoHS substances, including the requirement that RoHS substance do not exceed 0.1% by weight in homogeneous materials. Where designed to be soldered at high temperatures, "RoHS" products are suitable for use in specified lead-free processes. TI may reference these types of products as "Pb-Free".

**RoHS Exempt:** TI defines "RoHS Exempt" to mean products that contain lead but are compliant with EU RoHS pursuant to a specific EU RoHS exemption.

**Green:** TI defines "Green" to mean the content of Chlorine (Cl) and Bromine (Br) based flame retardants meet JS709B low halogen requirements of <=1000ppm threshold. Antimony trioxide based flame retardants must also meet the <=1000ppm threshold requirement.

(3) MSL, Peak Temp. - The Moisture Sensitivity Level rating according to the JEDEC industry standard classifications, and peak solder temperature.

(4) There may be additional marking, which relates to the logo, the lot trace code information, or the environmental category on the device.

(5) Multiple Device Markings will be inside parentheses. Only one Device Marking contained in parentheses and separated by a "~" will appear on a device. If a line is indented then it is a continuation of the previous line and the two combined represent the entire Device Marking for that device.

(6) Lead finish/Ball material - Orderable Devices may have multiple material finish options. Finish options are separated by a vertical ruled line. Lead finish/Ball material values may wrap to two lines if the finish value exceeds the maximum column width.

**Important Information and Disclaimer:**The information provided on this page represents TI's knowledge and belief as of the date that it is provided. TI bases its knowledge and belief on information provided by third parties, and makes no representation or warranty as to the accuracy of such information. Efforts are underway to better integrate information from third parties. TI has taken and continues to take reasonable steps to provide representative and accurate information but may not have conducted destructive testing or chemical analysis on incoming materials and chemicals. TI and TI suppliers consider certain information to be proprietary, and thus CAS numbers and other limited information may not be available for release.

In no event shall TI's liability arising out of such information exceed the total purchase price of the TI part(s) at issue in this document sold by TI to Customer on an annual basis.

**OTHER QUALIFIED VERSIONS OF TPS2105-EP :**

- Catalog: [TPS2105](#)

## NOTE: Qualified Version Definitions:

- Catalog - TI's standard catalog product

## TAPE AND REEL INFORMATION



### QUADRANT ASSIGNMENTS FOR PIN 1 ORIENTATION IN TAPE



\*All dimensions are nominal

Device	Package Type	Package Drawing	Pins	SPQ	Reel Diameter (mm)	Reel Width W1 (mm)	A0 (mm)	B0 (mm)	K0 (mm)	P1 (mm)	W (mm)	Pin1 Quadrant
TPS2105MDBVREP	SOT-23	DBV	5	3000	178.0	9.0	3.23	3.17	1.37	4.0	8.0	Q3

**TAPE AND REEL BOX DIMENSIONS**



\*All dimensions are nominal

Device	Package Type	Package Drawing	Pins	SPQ	Length (mm)	Width (mm)	Height (mm)
TPS2105MDBVREP	SOT-23	DBV	5	3000	180.0	180.0	18.0



# EXAMPLE BOARD LAYOUT

DBV0005A

SOT-23 - 1.45 mm max height

SMALL OUTLINE TRANSISTOR



LAND PATTERN EXAMPLE  
EXPOSED METAL SHOWN  
SCALE:15X

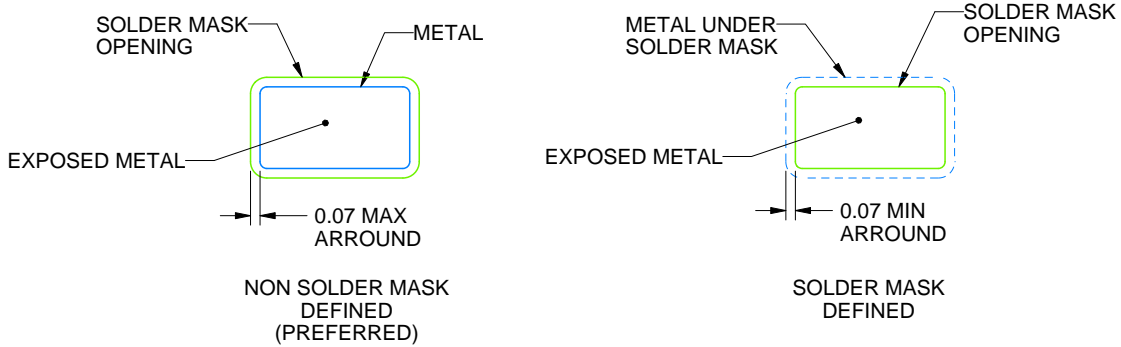

SOLDER MASK DETAILS

4214839/E 09/2019

NOTES: (continued)

- 5. Publication IPC-7351 may have alternate designs.
- 6. Solder mask tolerances between and around signal pads can vary based on board fabrication site.

# EXAMPLE STENCIL DESIGN

DBV0005A

SOT-23 - 1.45 mm max height

SMALL OUTLINE TRANSISTOR



SOLDER PASTE EXAMPLE  
BASED ON 0.125 mm THICK STENCIL  
SCALE:15X

4214839/E 09/2019

NOTES: (continued)

7. Laser cutting apertures with trapezoidal walls and rounded corners may offer better paste release. IPC-7525 may have alternate design recommendations.
8. Board assembly site may have different recommendations for stencil design.



## IMPORTANT NOTICE AND DISCLAIMER

TI PROVIDES TECHNICAL AND RELIABILITY DATA (INCLUDING DATASHEETS), DESIGN RESOURCES (INCLUDING REFERENCE DESIGNS), APPLICATION OR OTHER DESIGN ADVICE, WEB TOOLS, SAFETY INFORMATION, AND OTHER RESOURCES "AS IS" AND WITH ALL FAULTS, AND DISCLAIMS ALL WARRANTIES, EXPRESS AND IMPLIED, INCLUDING WITHOUT LIMITATION ANY IMPLIED WARRANTIES OF MERCHANTABILITY, FITNESS FOR A PARTICULAR PURPOSE OR NON-INFRINGEMENT OF THIRD PARTY INTELLECTUAL PROPERTY RIGHTS.

These resources are intended for skilled developers designing with TI products. You are solely responsible for (1) selecting the appropriate TI products for your application, (2) designing, validating and testing your application, and (3) ensuring your application meets applicable standards, and any other safety, security, or other requirements. These resources are subject to change without notice. TI grants you permission to use these resources only for development of an application that uses the TI products described in the resource. Other reproduction and display of these resources is prohibited. No license is granted to any other TI intellectual property right or to any third party intellectual property right. TI disclaims responsibility for, and you will fully indemnify TI and its representatives against, any claims, damages, costs, losses, and liabilities arising out of your use of these resources.

TI's products are provided subject to TI's Terms of Sale ([www.ti.com/legal/termsofsale.html](http://www.ti.com/legal/termsofsale.html)) or other applicable terms available either on [ti.com](http://ti.com) or provided in conjunction with such TI products. TI's provision of these resources does not expand or otherwise alter TI's applicable warranties or warranty disclaimers for TI products.

Mailing Address: Texas Instruments, Post Office Box 655303, Dallas, Texas 75265  
Copyright © 2020, Texas Instruments Incorporated