

Part Number	Description
FS24D10-06	10A, 280 Vac
FS24D10	10A, 280 Vac
FS24D20-06	20A, 280 Vac

Part Number Explanation

FS	24	D	10	-06
Series	Line Voltage ¹	Switch Type ²	Output Current – Amps	Feature ³

NOTES

- 1) Line Voltage 24 = 240 Vac
- 2) Switch Type: D = Zero-cross turn-on
- 3) Feature: -0.6 = Faston terminals

MECHANICAL SPECIFICATION

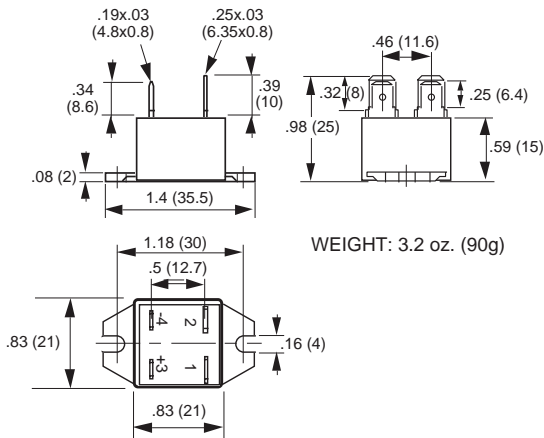

WEIGHT: 3.2 oz. (90g)

Figure 1 — FS relays except FS24D10

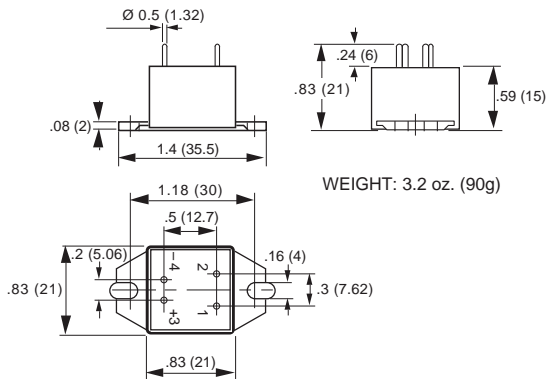

WEIGHT: 3.2 oz. (90g)

Figure 1b — FS24D10



FEATURES/BENEFITS

- Miniature size package
- Designed for medium-power applications
- Faston or PCB terminals available
- Tight zero-cross window for low EMI
- Excellent thermal performance
- High immunity to surges

DESCRIPTION

The Series FS relays are designed for medium power loads. The design incorporates a triac output. The Series FS relays utilize optical isolation to protect the control from load transients. The FS compact package is available with faston or PCB terminals. Its compact size makes it ideal for designs where space is limited. The Series FS relays have excellent thermal performance.

APPLICATIONS

- Heating control
- Motor control
- Uninterruptible power supplies
- Light dimmers
- Industrial and process control
- On/Off controls of medium-power AC equipment
- Electromechanical line relay replacement

APPROVALS

All models are UL recognized.
UL File Number: E128555.

EQUIVALENT CIRCUIT

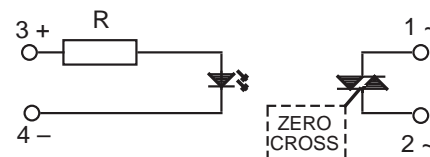

Figure 2 — FS relays

INPUT (CONTROL) SPECIFICATION

	Min	Max	Units
Control Range	4	30	Vdc
Input Current Range	3	30	mAdc
Must Turn-off Voltage		1	Vdc
Input Resistance (Typical)		1000	Ohms
Reverse Voltage Protection		30	V

OUTPUT (LOAD) SPECIFICATION

Input Type	Min	Max	Unit
Operating Range	12	280	Vrms
Peak Voltage		600	Vpeak
Load Current Range (Resistive)			
10A output current	.005	10	Arms
20A output current	.005	20	Arms
Inductive Load Current			
10A output current		2.5	Arms
20A output current		4	Arms
Maximum Surge Current Rating (Non-Repetitive)			
10A output current		120	A
20A output current		200	A
On-State Voltage Drop		1.3	V
Zero Cross Window (Typical)		12	Vac
Off-State Leakage Current (60Hz)		3	mA
Turn-On Time (60Hz)		8.3	ms
Turn-Off Time (60Hz)		8.3	ms
Off-State dv/dt		500	V/μs
Maximum di/dt (Non-Repetitive)		50	A/μs

OUTPUT (LOAD) SPECIFICATION (continued)

Input Type	Min	Max	Unit
Operating Frequency Range			
	0.1	440	Hz
I ² T for Match Fusing (<8.3ms)			
10A output current	.005	72	A ² S
20A output current	.005	200	A ² S

CONTROL CHARACTERISTIC

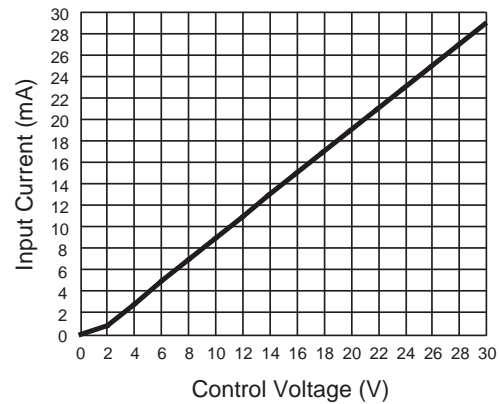

Figure 3 — FS relays

ENVIRONMENTAL SPECIFICATION

	Min	Max	Unit
Operating Temperature	-40	100	°C
Storage Temperature	-40	100	°C
Input-Output Isolation	4000		Vrms
Output-Case Isolation	3300		Vrms

NOTES:

1. External snubber is recommended when switching inductive loads.
2. Electrical specifications at 25°C unless otherwise specified.
3. For 800Hz applications, contact factory.
4. For additional/custom options, contact factory.

THERMAL CHARACTERISTICS

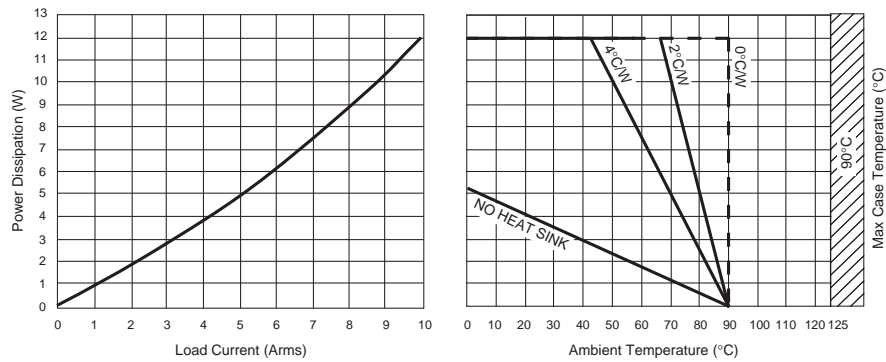

Figure 5a — All 10A FS relays output current

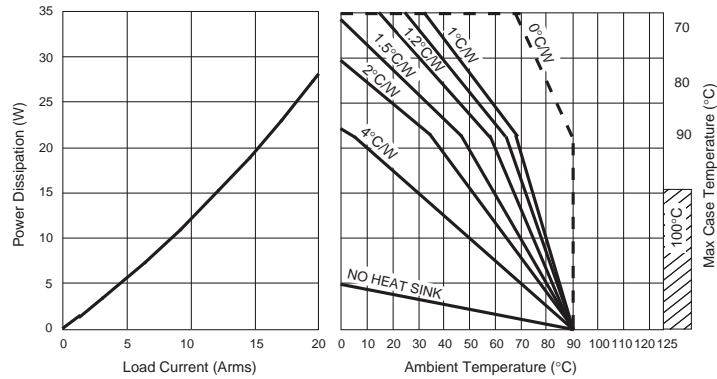

Figure 5b — FS24D20-06 output current

SURGE CURRENT

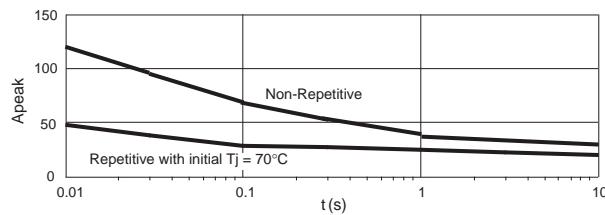

Figure 4a — All 10A FS relays output current

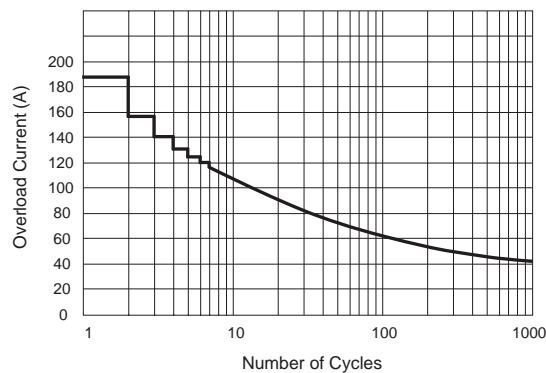

Figure 4b — FS24D20-06 output current

Mouser Electronics

Authorized Distributor

Click to View Pricing, Inventory, Delivery & Lifecycle Information:

[Teledyne Relays:](#)

[FS24D20-06/R](#) [FS24D10-06/R](#)