

SW/SC001/003 Series DC-DC Converter Power Modules:

18-36V & 36-75Vdc Input; 3.3V-15Vdc Output; 1-3.5A Output Current



Representative Photo.
Actual product may vary.

RoHS Compliant

Applications

- Wireless Networks
- Distributed power architectures
- Optical and Access Network Equipment
- Enterprise Networks
- Latest generation IC's (DSP, FPGA, ASIC) and Microprocessor powered applications

Options

- Remote On/Off logic (positive or negative), pin optional for TH version (Suffix 1 or 4)
- Output voltage adjustment-Trim, pin optional for TH version (Suffix 9)
- Surface Mount/Tape and Reel (-SR Suffix)

Description

The SW/SC series power modules are isolated dc-dc converters that operate over a wide range of input voltage ($V_{IN} = 18 - 36Vdc$ for SC modules and $V_{IN} = 36 - 75Vdc$ for SW modules) and provide a single precisely regulated output. This series is a low cost, smaller size alternative to the existing LW/LAW/LC with enhanced performance parameters. The output is fully isolated from the input, allowing versatile polarity configurations and grounding connections. The modules exhibit high efficiency, typical efficiency of 86% for 5.0V/3A. Built-in filtering for both input and output minimizes the need for external filtering.

Features

- Compliant to RoHS II EU Directive 2011/65/EC and amended Directive (EU) 2015/863. (-Z versions)
- Compliant to REACH Directive (EC) No 1907/2006
- Delivers up to 3.5A Output current
15V (1A), 12V (1.25A), 5.0V (3A) and 3.3V (3.5A)
- High efficiency – 86% at 5.0V full load ($V_{IN}=54 Vdc$)
- Low output ripple and noise
- Small Size and low profile
27.94mm x 24.38mm x 8.5mm
(1.10 x 0.96 x 0.335 in)
- Industry Standard pin-out:
TH version is LW series compatible
- Surface mount (SMT) or Through hole (TH)
- Remote On/Off (optional pin on TH version)
- Output overcurrent/voltage protection
- Single Tightly regulated output
- Output voltage adjustment trim $\pm 10\%$
- Wide operating temperature range (-40°C to 85°C)
- Meets the voltage insulation requirements for ETSI 300-132-2 and complies with and is Licensed for Basic Insulation
- CE mark meets the 2014/35/EU directive[§]
- ANSI/UL* 62368-1 and CAN/CSA† C22.2 No. 62368-1 Recognized, DIN VDE‡ 0868-1/A11:2017 (EN62368-1:2014/A11:2017)
- ISO** 9001 and ISO 14001 certified manufacturing facilities

§ This product is intended for integration into end-use equipment. All of the required procedures of end-use equipment should be followed.

* UL is a registered trademark of Underwriters Laboratories, Inc.

† CSA is a registered trademark of Canadian Standards Association.

‡ VDE is a trademark of Verband Deutscher Elektrotechniker e.V.

** ISO is a registered trademark of the International Organization of Standards

SW/SC001/003 Series DC-DC Power Module

18-36Vdc & 36-75Vdc Input; 3.3-15Vdc Output; 1-3.5A Output Current

Absolute Maximum Ratings

Stresses in excess of the absolute maximum ratings can cause permanent damage to the device. These are absolute stress ratings only, functional operation of the device is not implied at these or any other conditions in excess of those given in the operations sections of the data sheet. Exposure to absolute maximum ratings for extended periods can adversely affect the device reliability.

Parameter	Device	Symbol	Min	Max	Unit
Input Voltage (Continuous)	SW	V_{IN}	-0.3	80	Vdc
	SC	V_{IN}	-0.3	50	Vdc
	All	$V_{IN,trans}$	-0.3	100	Vdc
Operating Ambient Temperature (see Thermal Considerations section)	All	T_A	-40	85	°C
Storage Temperature	All	T_{stg}	-55	125	°C
I/O Isolation Voltage (100% factory Hi-Pot tested)	All	—	—	2250	Vdc

Electrical Specifications

Unless otherwise indicated, specifications apply over all operating input voltage, resistive load, and temperature conditions.

Parameter	Device	Symbol	Min	Typ	Max	Unit
Operating Input Voltage	SW	V_{IN}	36	54	75	Vdc
	SC	V_{IN}	18	27	36	Vdc
Maximum Input Current ($V_{IN}=0V$ to 75V, $I_O=I_{O,max}$) ($V_{IN}=0V$ to 36V, $I_O=I_{O,max}$)	SW	$I_{IN,max}$			0.6	Adc
	SC	$I_{IN,max}$			1.2	Adc
Inrush Transient	All	I^2t			0.05	A ² s
Input Reflected Ripple Current, peak-to-peak (5Hz to 20MHz, 12μH source impedance; $V_{IN}=0V$ to 75V, $I_O=I_{O,max}$; see Test configuration section)	All			30		mAp-p
Input Ripple Rejection (120Hz)	All			50		dB
EMC, EN55032			See EMC Considerations section			

CAUTION: This power module is not internally fused. An input line fuse must always be used.

This power module can be used in a wide variety of applications, ranging from simple standalone operation to being part of complex power architecture. To preserve maximum flexibility, internal fusing is not included; however, to achieve maximum safety and system protection, always use an input line fuse. The safety agencies require a fast-acting fuse with a maximum rating of 3A (see Safety Considerations section). Based on the information provided in this data sheet on inrush energy and maximum dc input current, the same type of fuse with a lower rating can be used. Refer to the fuse manufacturer's data sheet for further information.

SW/SC001/003 Series DC-DC Power Module

18-36Vdc & 36-75Vdc Input; 3.3-15Vdc Output; 1-3.5A Output Current

Electrical Specifications (continued)

Parameter	Device	Symbol	Min	Typ	Max	Unit
Output Voltage Set-point ($V_{IN}=V_{IN,nom}$, $I_O=I_{O,max}$, $T_A=25^\circ C$)	All	$V_{O,set}$	-1.5	—	+1.5	% $V_{O,set}$
Output Voltage (Over all operating input voltage, resistive load, and temperature conditions until end of life)		V_O	-3.0	—	+3.0	% $V_{O,set}$
Adjustment Range Selected by external resistor	All	$V_{O,adj}$	-10.0		+10.0	% $V_{O,set}$
Output Regulation Line ($V_{IN}=V_{IN,min}$ to $V_{IN,max}$) (relative to actual $V_{O,set}$ at 50% load) Load ($I_O=I_{O,min}$ to $I_{O,max}$) (relative to actual $V_{O,set}$ at Typical V_{IN}) Temperature ($T_{ref}=T_{A,min}$ to $T_{A,max}$)	All All All		— — —	0.05 0.05 —	0.3 0.2 1.00	% $V_{O,set}$ % $V_{O,set}$ % $V_{O,set}$
Output Ripple and Noise on nominal output Measured with 10uF Tantalum and 1uF ceramic ($V_{IN}=V_{IN,nom}$, $I_O=80\%I_{O,max}$, $T_A=25^\circ C$)						
RMS (5Hz to 20MHz bandwidth)	5V, 3.3V		—	—	25	mV _{rms}
Peak-to-Peak (5Hz to 20MHz bandwidth)	5V, 3.3V		—	—	75	mV _{pk-pk}
RMS (5Hz to 20MHz bandwidth)	15V, 12V		—	—	35	mV _{rms}
Peak-to-Peak (5Hz to 20MHz bandwidth)	15V, 12V		—	—	100	mV _{pk-pk}
External Capacitance	3.3V, 5V 12V, 15V	$C_{O,max}$ $C_{O,max}$	0 0	— —	1000 220	μF μF
Output Current	15V 12V 5V 3.3V	I_O I_O I_O I_O	0 0 0 0	— — — —	1.0 1.25 3.0 3.5	Adc Adc Adc Adc
Output Current Limit Inception (Hiccup Mode)	15V 12V 5V 3.3V	$I_{O,lim}$ $I_{O,lim}$ $I_{O,lim}$ $I_{O,lim}$	1.1 1.4 3.2 3.7	— — 4.2 —	— — — —	Adc Adc Adc Adc
Output Short-Circuit Current $V_O \leq 250$ mV @ $25^\circ C$	15V 12V 5V 3.3V	$I_{O,s/c}$ $I_{O,s/c}$ $I_{O,s/c}$ $I_{O,s/c}$	— — — —	— — — —	0.8 1.2 0.7 1.5	Arms Arms Arms Arms
Efficiency $V_{IN}=V_{IN,nom}$, $T_A=25^\circ C$ $I_O=I_{O,max}$, $V_O=V_{O,set}$	SW (15V) SW (12V) SW (5.0V) SW (3.3V) SC (12V) SC (5.0V) SC (3.3V)	η η η η η η η	— — — 83.0 — — —	88.0 87.0 86.0 85.0 85.0 85.5 85.5	— — — — — — —	% % % % % % %
Switching Frequency (Variable with Line & Load) $V_{IN}=V_{IN,nom}$ and $I_O=I_{O,max}$ $V_{IN}=V_{IN,nom}$ and $I_O=0.5 \times I_{O,max}$	All All	f_{sw} f_{sw}	— —	300 440	— —	kHz kHz

SW/SC001/003 Series DC-DC Power Module

18-36Vdc & 36-75Vdc Input; 3.3-15Vdc Output; 1-3.5A Output Current

Electrical Specifications (continued)

Parameter	Device	Symbol	Min	Typ	Max	Unit
Dynamic Load Response ($\Delta I_o/\Delta t=0.1A/\mu s$, $V_{IN}=V_{IN, nom}$, $T_A=25^\circ C$) Load Change from $I_o=50\%$ to 75% or 25% to 50% of $I_{o,max}$:						
Peak Deviation	All	V_{pk}	—	1.5	—	% $V_{o, set}$
Settling Time ($V_o<10\%$ peak deviation)	All	t_s	—	800	—	μs

Isolation Specifications

Parameter	Symbol	Min	Typ	Max	Unit
Isolation Capacitance	C_{iso}	—	65	—	pF
Isolation Resistance	R_{iso}	10	—	—	M Ω
I/O Isolation Voltage	All	—	—	2250	Vdc

General Specifications

Parameter	Min	Typ	Max	Unit
Calculated MTBF (for SW003A0A91 in accordance with Lineage Power RIN: $I_o=80\%$ of $I_{o, max}$, $T_A=25^\circ C$, airflow=1m/s)		8,200,000		Hours
Weight	—	7.9	—	g (oz.)

SW/SC001/003 Series DC-DC Power Module

18-36Vdc & 36-75Vdc Input; 3.3-15Vdc Output; 1-3.5A Output Current

Feature Specifications

Unless otherwise indicated, specifications apply over all operating input voltage, resistive load, and temperature conditions. See Feature Descriptions for additional information.

Parameter	Device	Symbol	Min	Typ	Max	Unit
Remote On/Off Signal Interface ($V_{IN}=V_{IN, min}$ to $V_{IN, max}$; open collector or equivalent, Signal referenced to V_{IN} -terminal) Negative Logic: device code suffix "1" Logic Low = module On, Logic High = module Off Positive Logic: No device code suffix required Logic Low = module Off, Logic High = module On Logic Low - Remote On/Off Current Logic Low - On/Off Voltage Logic High Voltage – (Typ = Open Collector) Logic High maximum allowable leakage current	All	$I_{on/off}$	—	—	1.0	mA
	All	$V_{on/off}$	-0.7	—	1.2	V
	All	$V_{on/off}$	—	5.8	15	V
	All	$I_{on/off}$	—	—	50	μ A
Turn-On Delay and Rise Times ($I_O=80\%$ of $I_{O, max}$, $T_A=25^\circ\text{C}$) Case 1: On/Off input is set ON and then input power is applied (T_{delay} = from instant at which $V_{IN}=V_{IN, min}$ until $V_O = 10\%$ of $V_{O, set}$). Case 2: Input power is applied for at least 1 second and then On/Off input is set from OFF to ON (T_{delay} = from instant at which $V_{IN}=V_{IN, min}$ until $V_O = 10\%$ of $V_{O, set}$). T_{rise} = time for V_O to rise from 10% of $V_{O, set}$ to 90% of $V_{O, set}$. T_{rise} = time for V_O to rise from 10% of $V_{O, set}$ to 90% of $V_{O, set}$ with max ext capacitance	All	T_{delay} Case1	—	20	50	ms
	All	T_{delay} Case2	—	20	50	ms
	All	T_{rise}	—	0.1	1	ms
	All	T_{rise}	—	1.5	—	ms
Output Voltage Overshoot ($I_O=80\%$ of $I_{O, max}$, $V_{IN}= 54\text{V}$, $T_A=25^\circ\text{C}$)					3	% $V_{O, set}$
Output Overvoltage Protection	15V	$V_{O, limit}$	16.6	—	21.0	V
	12V	$V_{O, limit}$	13.3	—	16.0	V
	5.0V	$V_{O, limit}$	5.6	—	7.0	V
	3.3V	$V_{O, limit}$	3.7	—	5.4	V
Input Undervoltage Lockout						
Turn-on Threshold	SW	$V_{uv/on}$	—	33	36	V
Turn-off Threshold	SW	$V_{uv/off}$	27.5	30.5	—	V
Hysteresis	SW	V_{hyst}	—	2.5	—	V
Turn-on Threshold	SC	$V_{uv/on}$	—	17	18	V
Turn-off Threshold	SC	$V_{uv/off}$	13.5	14.5	—	V
Hysteresis	SC	V_{hyst}	—	3.0	—	V

SW/SC001/003 Series DC-DC Power Module

18-36Vdc & 36-75Vdc Input; 3.3-15Vdc Output; 1-3.5A Output Current

Characteristic Curves

The following figures provide typical characteristics for the SW001A0C91 (15.0V, 1A) at 25°C. The figures are identical for either positive or negative Remote On/Off logic.

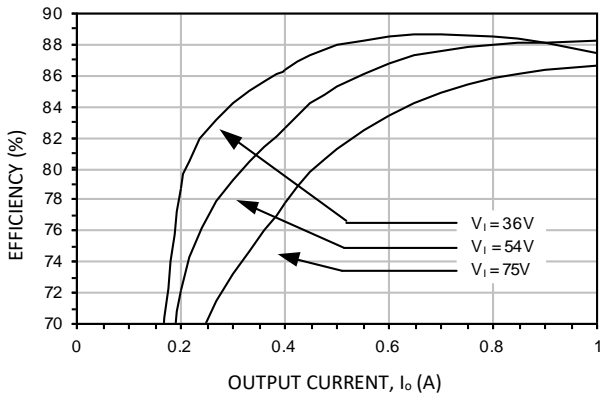

Figure 1. Converter Efficiency versus Output Current.

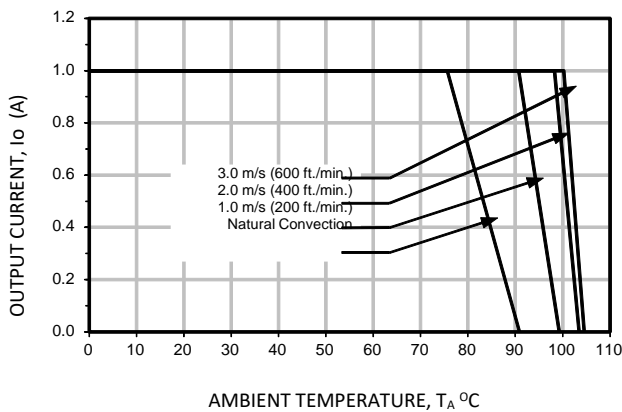

Figure 2. Derating Output Current versus Local Ambient Temperature and Airflow.

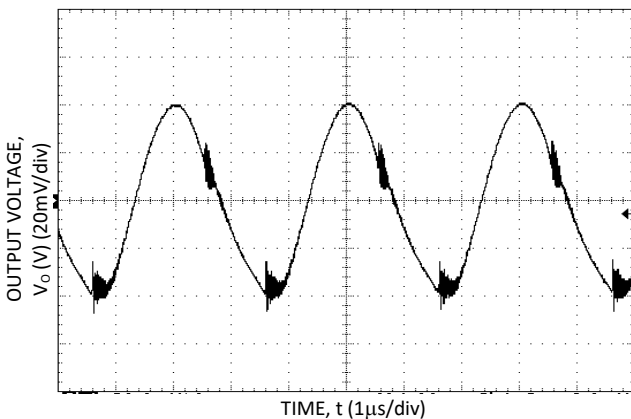

Figure 3. Typical Output Ripple and Noise, $V_{IN}=V_{IN, nom}$ $I_O=80\%$ of $I_{O, max}$.

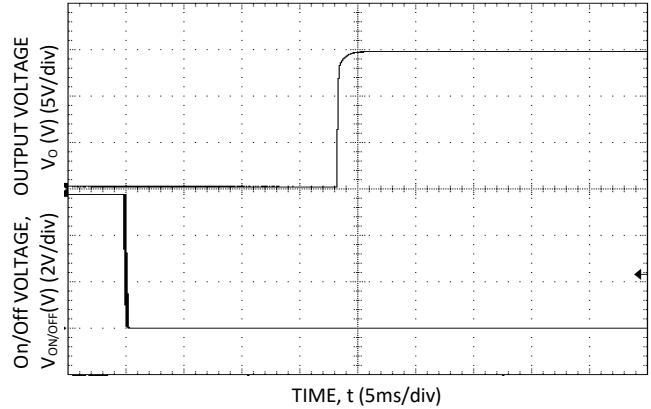

Figure 4. Typical Start-Up Using Remote On/Off, negative logic version shown.

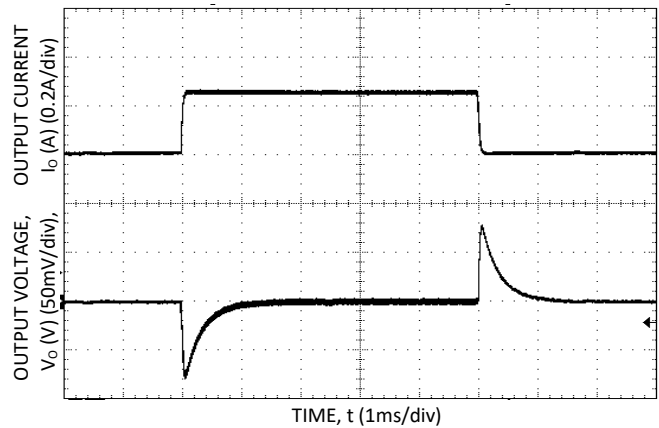

Figure 5. Transient Response to Dynamic Load Change from 50% to 75% to 50% of full load.

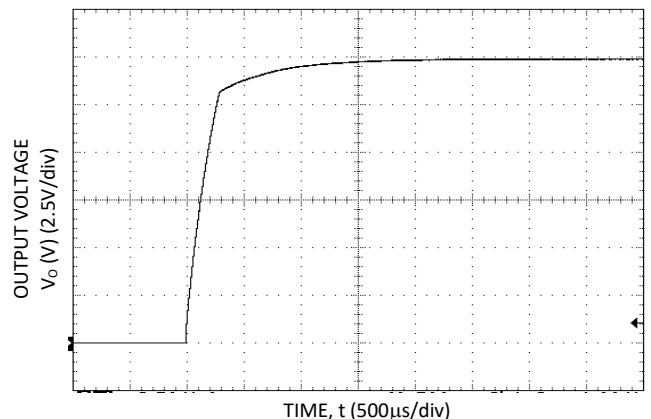

Figure 6. Typical Start-Up Output Voltage Rise Characteristic.

SW/SC001/003 Series DC-DC Power Module

18-36Vdc & 36-75Vdc Input; 3.3-15Vdc Output; 1-3.5A Output Current

Characteristic Curves (continued)

The following figures provide typical characteristics for the SW001A2B91 (12.0V, 1.2A) at 25°C. The figures are identical for either positive or negative Remote On/Off logic.

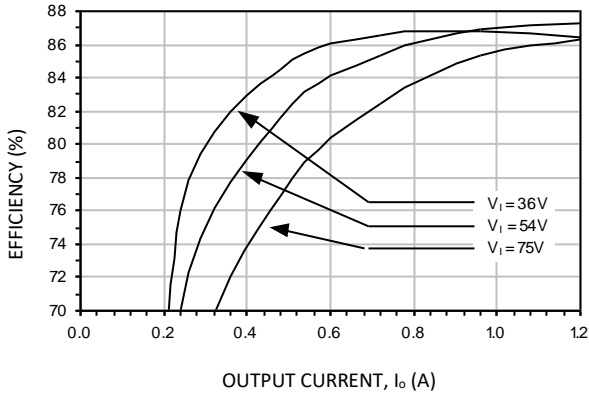

Figure 7. Converter Efficiency Vs Load at $V_o = 12\text{ V}$.

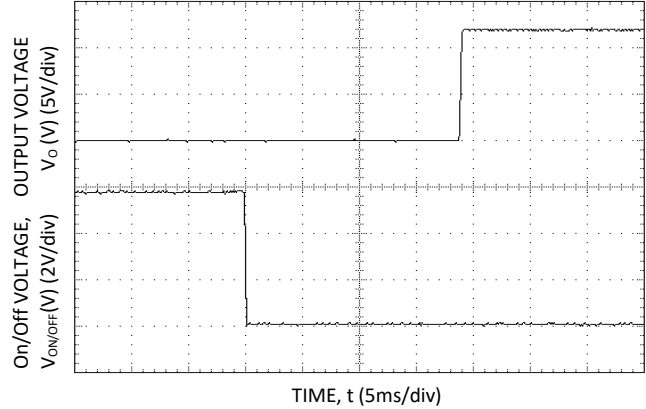

Figure 10. Typical Start-Up Using Remote On/Off, negative logic version shown.

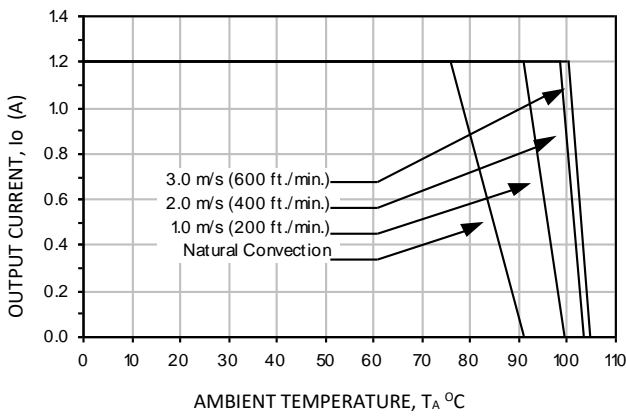

Figure 8. Derating Output Current versus Local Ambient Temperature and Airflow.

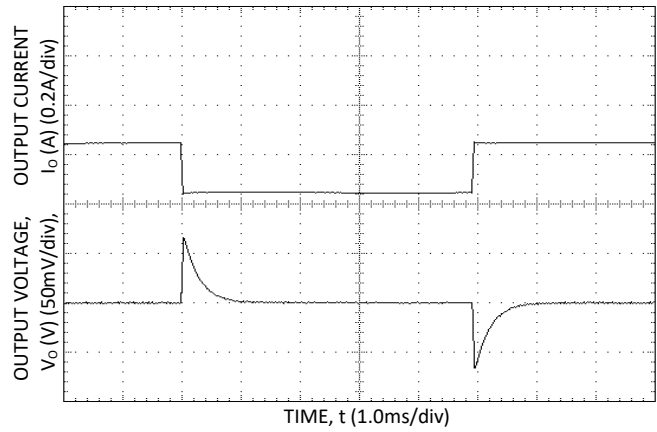

Figure 11. Transient Response to Dynamic Load Change from 50% to 75% to 50% of full load.

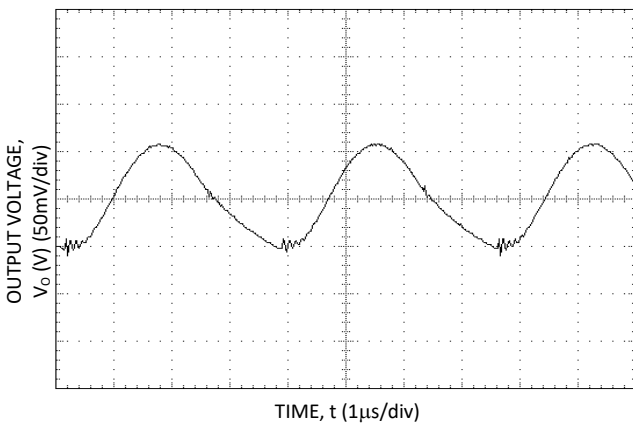

Figure 9. Typical Output Ripple and Noise, $V_{IN} = V_{IN, nom}$, $I_o = 80\%$ of $I_{o, max}$.

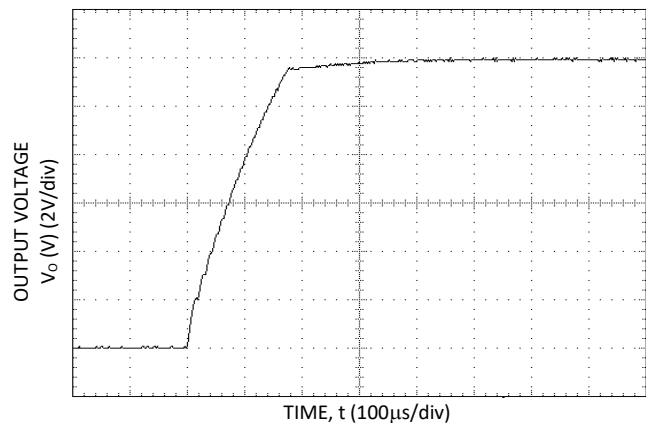

Figure 12. Typical Start-Up Output Voltage Rise Characteristic.

SW/SC001/003 Series DC-DC Power Module

18-36Vdc & 36-75Vdc Input; 3.3-15Vdc Output; 1-3.5A Output Current

Characteristic Curves (continued)

The following figures provide typical characteristics for the SW003A0A91 (5.0V, 3A) at 25°C. The figures are identical for either positive or negative Remote On/Off logic.

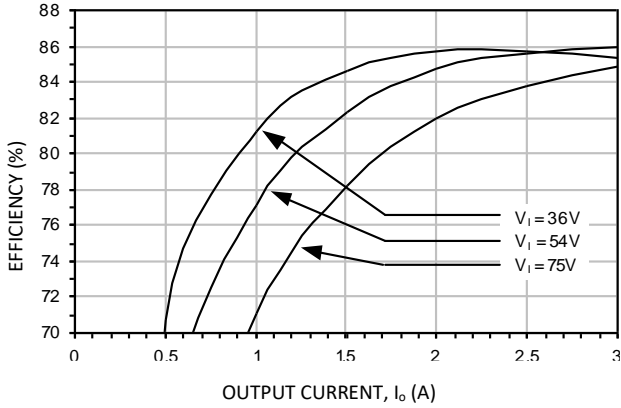

Figure 13. Converter Efficiency Vs Load at $V_o = 5V$.

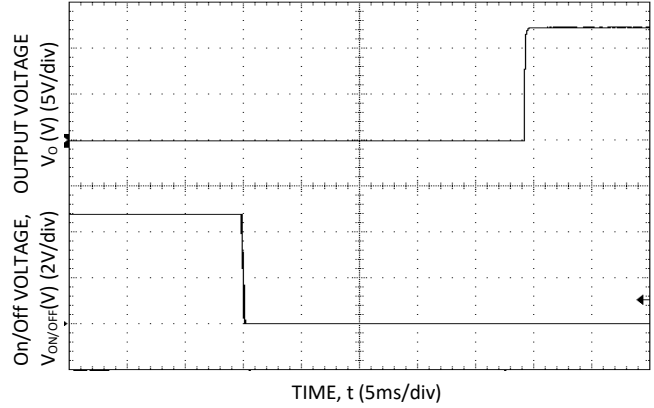

Figure 16. Typical Start-Up Using Remote On/Off, negative logic version shown.

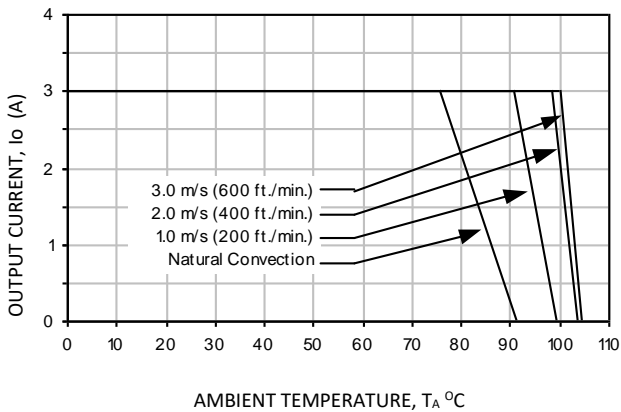

Figure 14. Derating Output Current versus Local Ambient Temperature and Airflow.

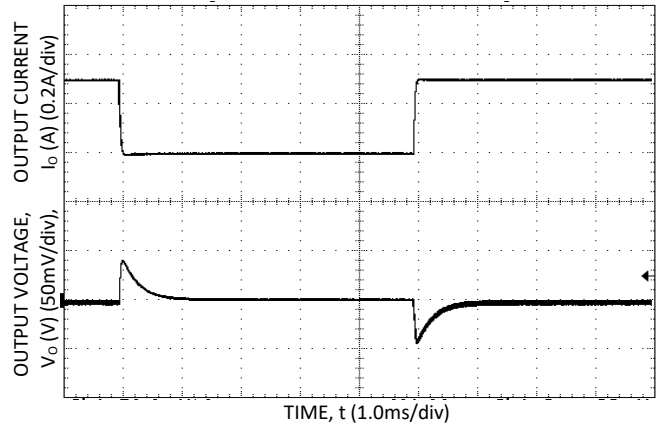

Figure 17. Transient Response to Dynamic Load Change from 50% to 75% to 50% of full load.

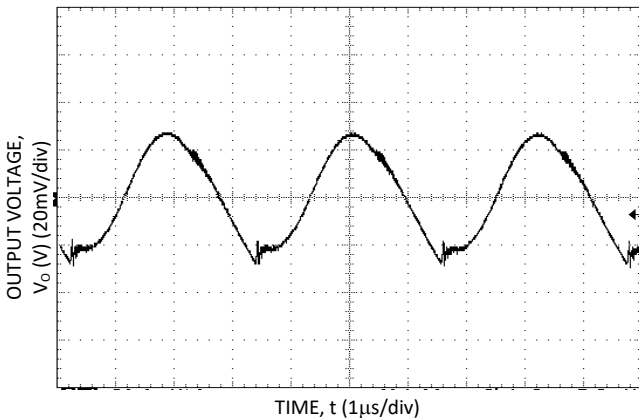

Figure 15. Typical Output Ripple and Noise, $V_{IN} = V_{IN, nom}$, $I_o = 80\%$ of $I_{o, max}$.

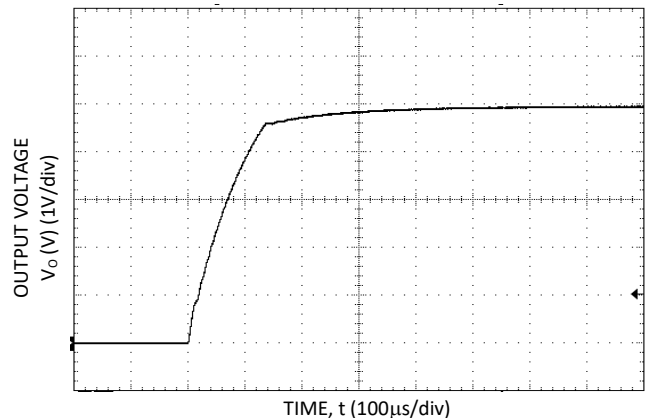

Figure 18. Typical Start-Up Output Voltage Rise Characteristic.

SW/SC001/003 Series DC-DC Power Module

18-36Vdc & 36-75Vdc Input; 3.3-15Vdc Output; 1-3.5A Output Current

Characteristic Curves (continued)

The following figures provide typical characteristics for the SW003A5F91 (3.3V, 3.5A) at 25°C. The figures are identical for either positive or negative Remote On/Off logic.

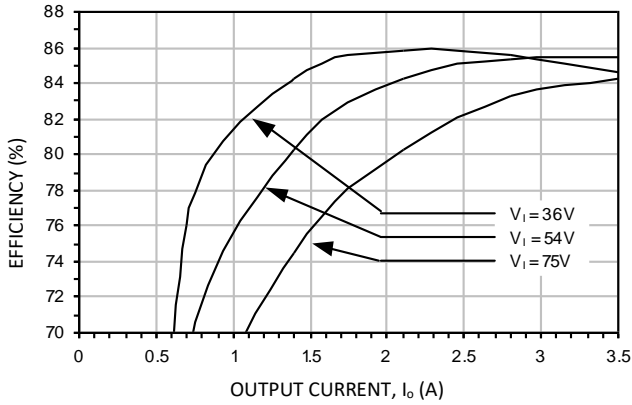

Figure 19. Converter Efficiency Vs Load.

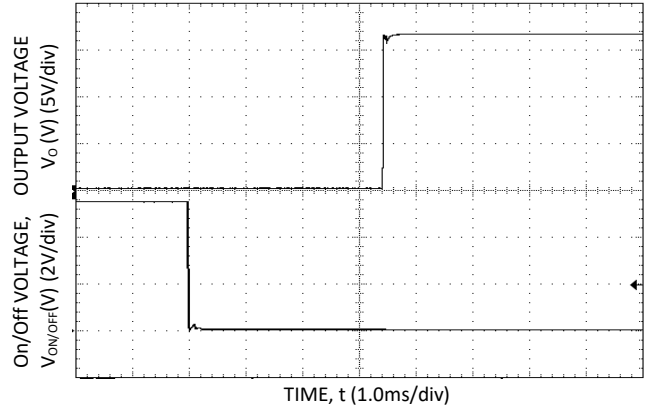

Figure 22. Typical Start-Up Using Remote On/Off, negative logic version shown.

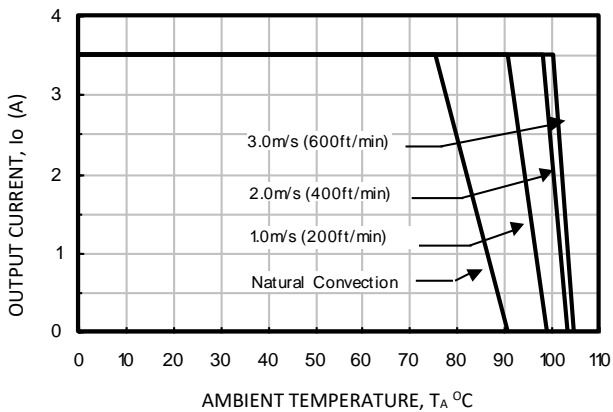

Figure 20. Derating Output Current versus Local Ambient Temperature and Airflow.

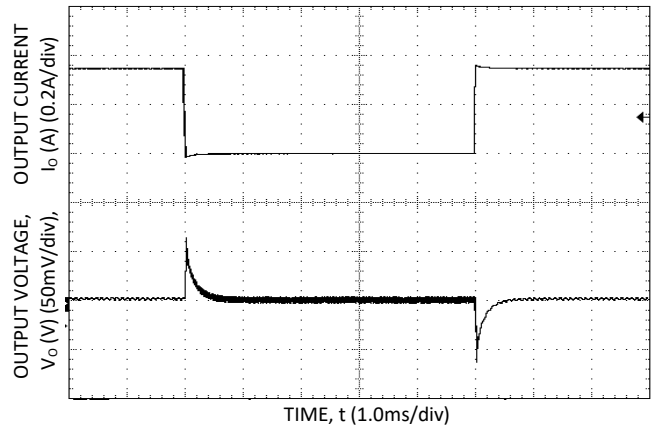

Figure 23. Transient Response to Dynamic Load Change from 50% to 75% to 50% of full load.

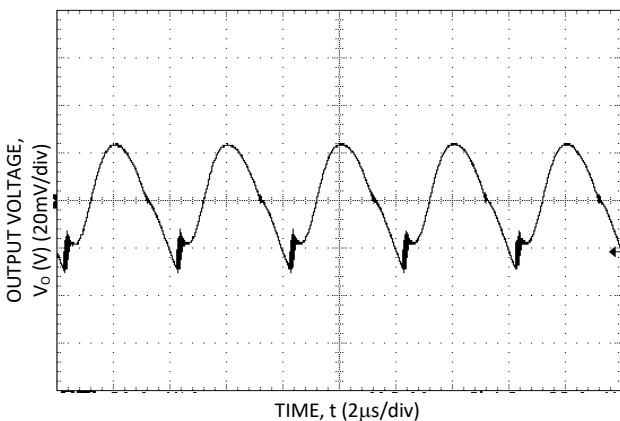

Figure 21. Typical Output Ripple and Noise, $V_{IN}=V_{IN, nom}$
 $I_o=80\%$ of $I_{o, max}$.

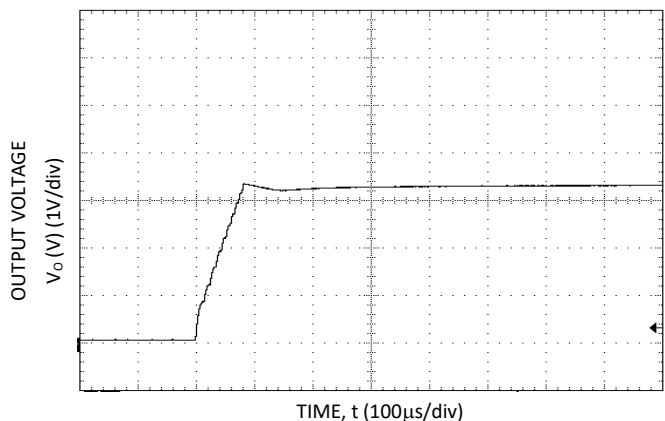

Figure 24. Typical Start-Up Output Voltage Rise Characteristic.

SW/SC001/003 Series DC-DC Power Module

18-36Vdc & 36-75Vdc Input; 3.3-15Vdc Output; 1-3.5A Output Current

Characteristic Curves (continued)

The following figures provide typical characteristics for the SC001A2B91 (12.0V, 1.2A) at 25°C. The figures are identical for either positive or negative Remote On/Off logic.

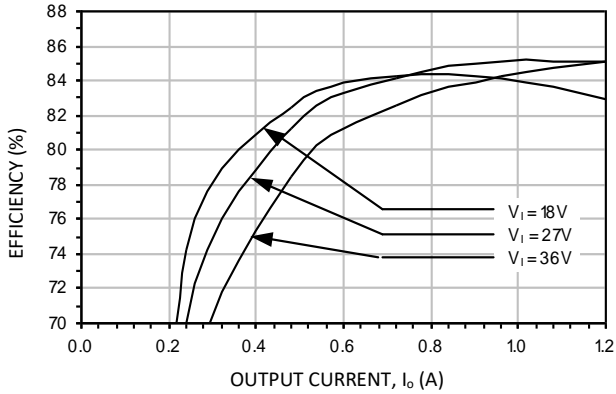

Figure 25. Converter Efficiency Vs Load.

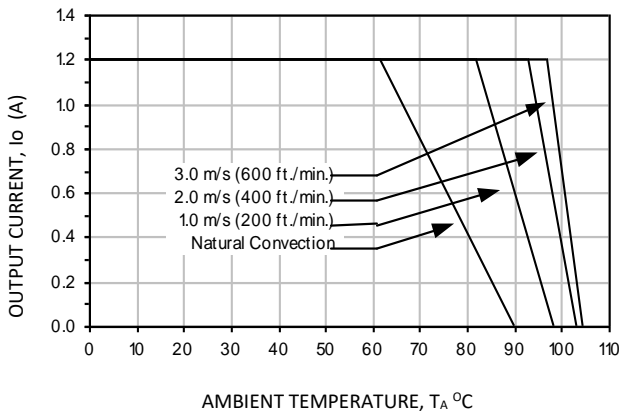

Figure 26. Derating Output Current versus Local Ambient Temperature and Airflow.

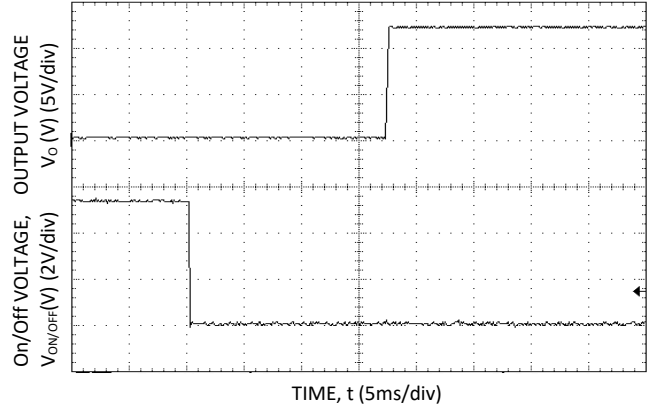

Figure 28. Typical Start-Up Using Remote On/Off, negative logic version shown.

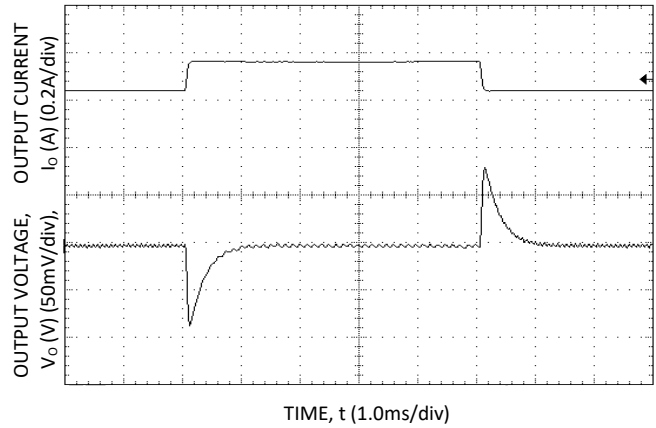

Figure 29. Transient Response to Dynamic Load Change from 50% to 75% to 50% of full load.

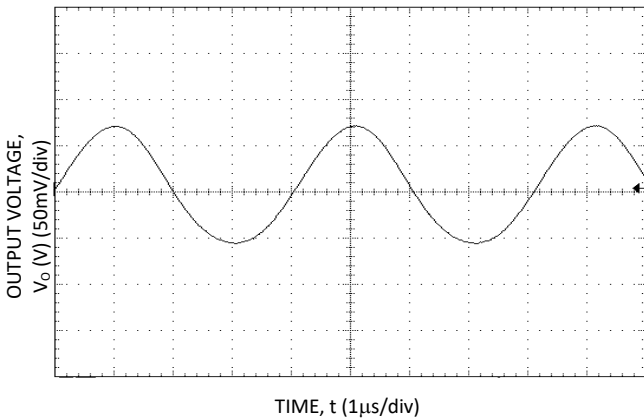

Figure 27. Typical Output Ripple and Noise, $V_{IN}=V_{IN, nom}$
 $I_o=80\%$ of $I_{o, max}$.

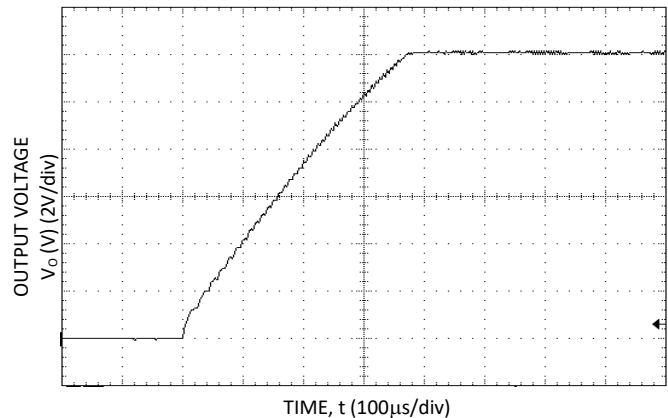

Figure 30. Typical Start-Up Output Voltage Rise Characteristic.

SW/SC001/003 Series DC-DC Power Module

18-36Vdc & 36-75Vdc Input; 3.3-15Vdc Output; 1-3.5A Output Current

Characteristic Curves (continued)

The following figures provide typical characteristics for the SC003A0A91 (5.0V, 3A) at 25°C. The figures are identical for either positive or negative Remote On/Off logic.

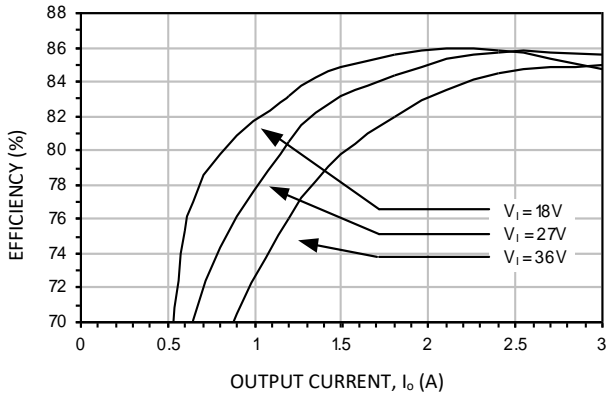

Figure 31. Converter Efficiency Vs Load.

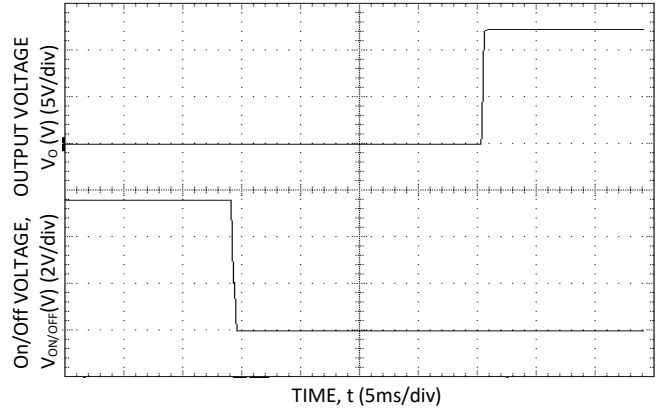

Figure 34. Typical Start-Up Using Remote On/Off, negative logic version shown.

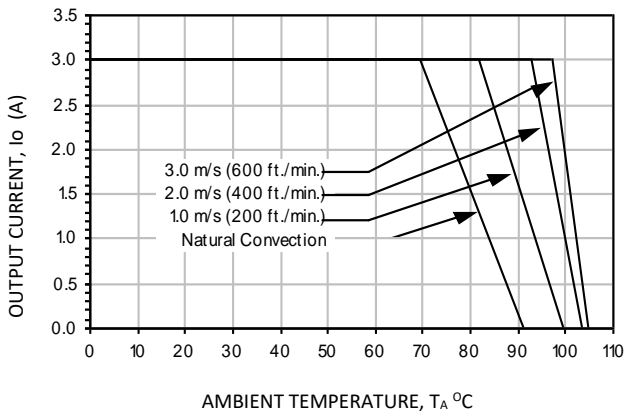

Figure 32. Derating Output Current versus Local Ambient Temperature and Airflow.

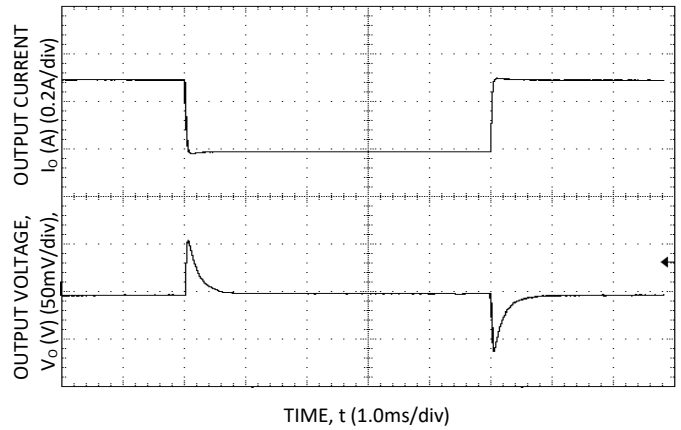

Figure 35. Transient Response to Dynamic Load Change from 50% to 75% to 50% of full load.

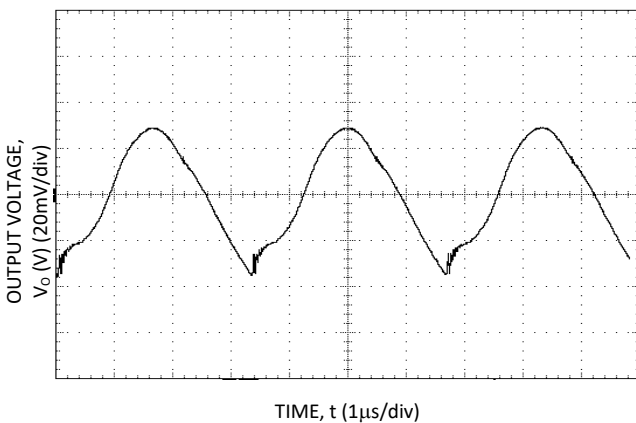

Figure 33. Typical Output Ripple and Noise, $V_{IN}=V_{IN, nom}$
 $I_o=80\%$ of $I_{o, max}$.

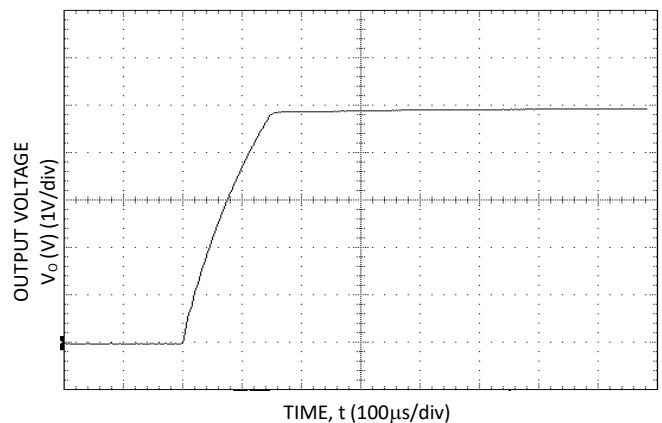

Figure 36. Typical Start-Up Output Voltage Rise Characteristic.

SW/SC001/003 Series DC-DC Power Module

18-36Vdc & 36-75Vdc Input; 3.3-15Vdc Output; 1-3.5A Output Current

Characteristic Curves (continued)

The following figures provide typical characteristics for the SC003A5F91 (3.3V, 3.5A) at 25°C. The figures are identical for either positive or negative Remote On/Off logic.

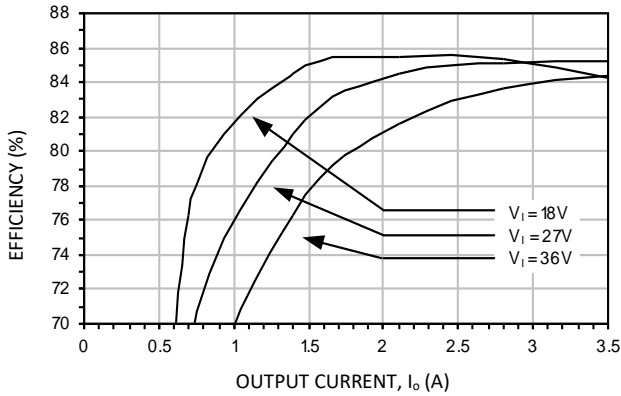

Figure 37. Converter Efficiency Vs Load.

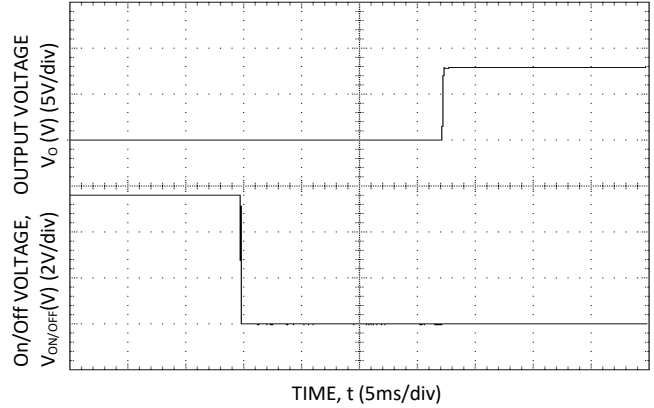

Figure 40. Typical Start-Up Using Remote On/Off, negative logic version shown.

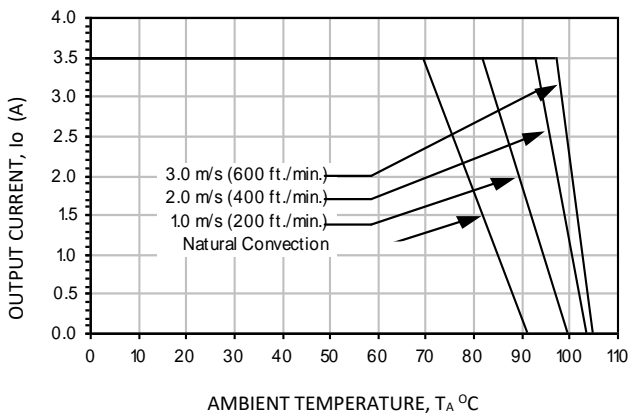

Figure 38. Derating Output Current versus Local Ambient Temperature and Airflow.

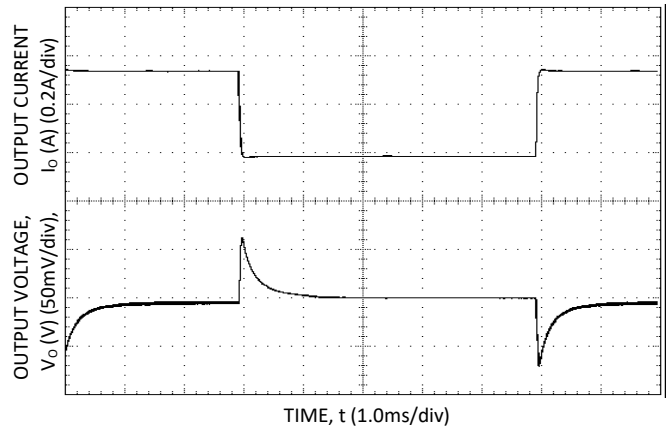

Figure 41. Transient Response to Dynamic Load Change from 50% to 75% to 50% of full load.

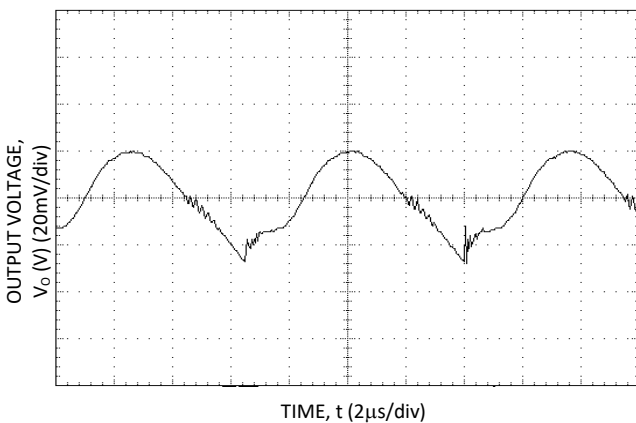

Figure 39. Typical Output Ripple and Noise, $V_{IN}=V_{IN,nom}$ $I_O=80\%$ of $I_{O,max}$.

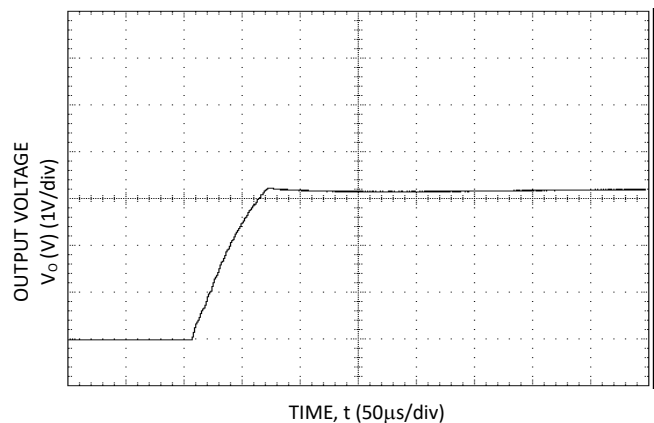
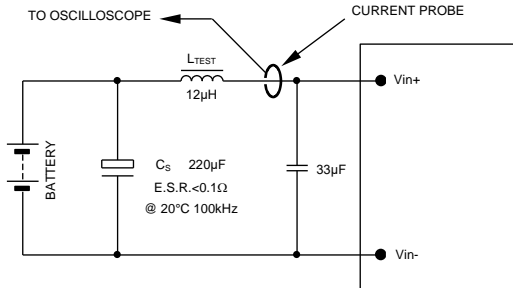

Figure 42. Typical Start-Up Output Voltage Rise Characteristic.

SW/SC001/003 Series DC-DC Power Module

18-36Vdc & 36-75Vdc Input; 3.3-15Vdc Output; 1-3.5A Output Current

Test Configurations



NOTE: Measure input reflected ripple current with a simulated source inductance (L_{TEST}) of 12µH. Capacitor C_s offsets possible battery impedance. Measure current as shown above.

Figure 43. Input Reflected Ripple Current Test Setup.

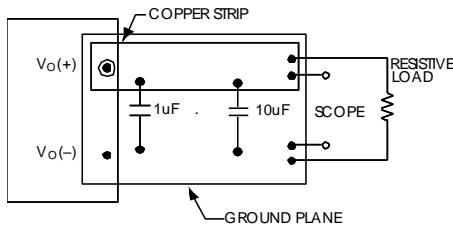

NOTE: All voltage measurements to be taken at the module terminals, as shown above. If sockets are used then Kelvin connections are required at the module terminals to avoid measurement errors due to socket contact resistance.

Figure 44. Output Ripple and Noise Test Setup.

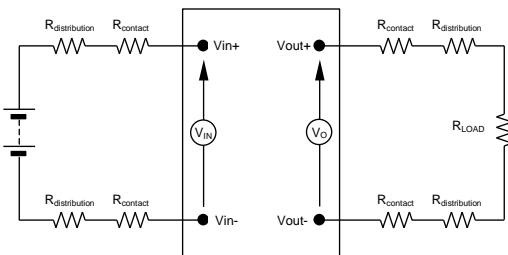

NOTE: All voltage measurements to be taken at the module terminals, as shown above. If sockets are used then Kelvin connections are required at the module terminals to avoid measurement errors due to socket contact resistance.

Figure 45. Output Voltage and Efficiency Test Setup.

$$\text{Efficiency } \eta = \frac{V_o \cdot I_o}{V_{IN} \cdot I_{IN}} \times 100 \%$$

Design Considerations

Input Source Impedance

The power module should be connected to a low ac-impedance source. Highly inductive source impedance can affect the stability of the power module. For the test configuration in Figure 43, a 33µF electrolytic capacitor (ESR<0.7Ω at 100kHz), mounted close to the power module helps ensure the stability of the unit. Consult the factory for further application guidelines.

Safety Considerations

For safety agency approval the power module must be installed in compliance with the spacing and separation requirements of the end-use safety agency standards, i.e., UL ANSI/UL 62368-1 and CAN/CSA C22.2 No. 62368-1 Recognized, DIN VDE 0868-1/A11:2017 (EN62368-1:2014/A11:2017).

If the input source is non-SELV (ELV or a hazardous voltage greater than 60 Vdc and less than or equal to 75Vdc), for the module’s output to be considered as meeting the requirements for safety extra-low voltage (SELV) or ES1, all of the following must be true:

- The input source is to be provided with reinforced insulation from any other hazardous voltages, including the ac mains.
- One V_{IN} pin and one V_{OUT} pin are to be grounded, or both the input and output pins are to be kept floating.
- The input pins of the module are not operator accessible.
- Another SELV or ES1 reliability test is conducted on the whole system (combination of supply source and subject module), as required by the safety agencies, to verify that under a single fault, hazardous voltages do not appear at the module’s output.

Note: Do not ground either of the input pins of the module without grounding one of the output pins. This may allow a non-SELV/ES1 voltage to appear between the output pins and ground.

The power module has safety extra-low voltage (SELV) or ES1 outputs when all inputs are SELV or ES1.

For input voltages exceeding –60 Vdc but less than or equal to –75 Vdc, these converters have been evaluated to the applicable requirements of BASIC INSULATION between secondary DC MAINS DISTRIBUTION input (classified as TNV-2 in Europe) and unearthed SELV outputs.

The input to these units is to be provided with a maximum 3A time-delay fuse in the ungrounded lead.

SW/SC001/003 Series DC-DC Power Module

18-36Vdc & 36-75Vdc Input; 3.3-15Vdc Output; 1-3.5A Output Current

Feature Description

Remote On/Off

Two remote on/off options are available. Positive logic turns the module on during a logic high voltage on the ON/OFF pin, and off during a logic low. Negative logic remote On/Off, device code suffix "1", turns the module off during a logic high and on during a logic low.

To maintain compatibility with LW series power modules the Remote On/Off pin is optional for the TH (through hole) version. Standard TH modules have no On/Off pin fitted. TH modules ordered with device code suffix "1" are negative logic with the On/Off pin fitted. The On/Off pin shall always be fitted on SMT versions.

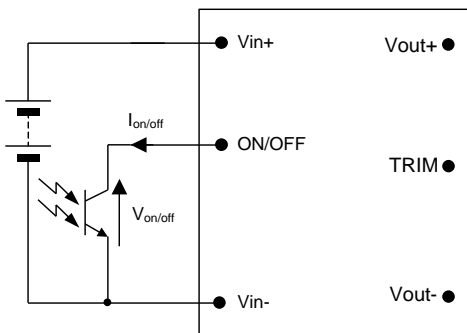

Figure 46. Circuit configuration for using Remote On/Off Implementation.

To turn the power module on and off, the user must supply a switch (open collector or equivalent) to control the voltage ($V_{on/off}$) between the ON/OFF terminal and the $V_{IN(-)}$ terminal. Logic low is $0V \leq V_{on/off} \leq 1.2V$. The maximum $I_{on/off}$ during a logic low is 1mA, the switch should be maintain a logic low level whilst sinking this current.

During a logic high, the typical $V_{on/off}$ generated by the module is 5.8V, and the maximum allowable leakage current at $V_{on/off} = 5.8V$ is $50\mu A$.

If not using the remote on/off feature:

For positive logic, leave the ON/OFF pin open.

For negative logic, short the ON/OFF pin to $V_{IN(-)}$.

Overcurrent Protection

To provide protection in a fault (output overload) condition, the unit is equipped with internal current-limiting circuitry and can endure current limiting continuously. At the point of current-limit inception, the unit enters hiccup mode. The unit operates normally once the output current is brought back into its specified range. The average output current during hiccup is 10% $I_{O, max}$.

Input Undervoltage Lockout

At input voltages below the input undervoltage lockout limit, the module operation is disabled. The module will only begin to operate once the input voltage is raised above the undervoltage lockout turn-on threshold, $V_{UV/ON}$.

Once operating, the module will continue to operate until the input voltage is taken below the undervoltage turn-off threshold, $V_{UV/OFF}$.

Over Voltage Protection

The output overvoltage protection consists of circuitry that internally clamps the output voltage. If a more accurate output overvoltage protection scheme is required then this should be implemented externally via use of the remote on/off pin.

Output Voltage Programming

Trimming allows the user to increase or decrease the output voltage set point of the module. This is accomplished by connecting an external resistor between the TRIM pin and either the V_{out+} pin or the V_{out-} pin.

Note: Trim pin is optional on TH module version and always present on SMT versions.

Trim Down – Decrease Output Voltage

By connecting an external resistor between the TRIM pin and V_{out+} pin ($R_{adj-down}$), the output voltage set point decreases (see figure 17). The following equation determines the external resistor value to obtain an output voltage change from $V_{o, nom}$ to the desired $V_{o, adj}$:

$$R_{adj-down} = \left[\frac{(V_{o, adj} - L) \times G}{(V_{o, nom} - V_{o, adj})} - H \right] \Omega$$

Note: Values for G, H, L and K are defined for each module version in the following table 1.

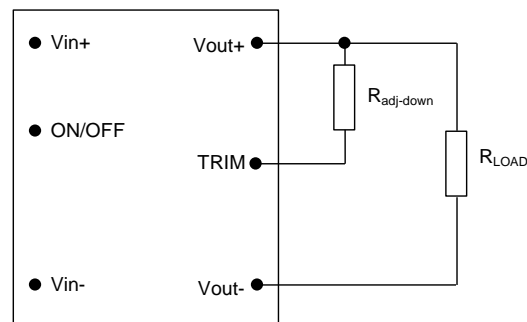

Figure 17. Circuit Configuration to Decrease Output Voltage.

SW/SC001/003 Series DC-DC Power Module

18-36Vdc & 36-75Vdc Input; 3.3-15Vdc Output; 1-3.5A Output Current

Trim Up – Increase Output Voltage

By connecting an external resistor between the TRIM pin and Vout- pin (Radj-up), the output voltage set point increases (see figure 48). The following equation determines the external resistor value to obtain an output voltage change from $V_{o, nom}$ to the desired $V_{o, adj}$:

Feature Descriptions (continued)

$$R_{adj-up} = \left[\frac{G \times L}{(V_{o,adj} - L - K)} - H \right] \Omega$$

Note: Values for G, H, L and K are defined for each module version in the following table 1.

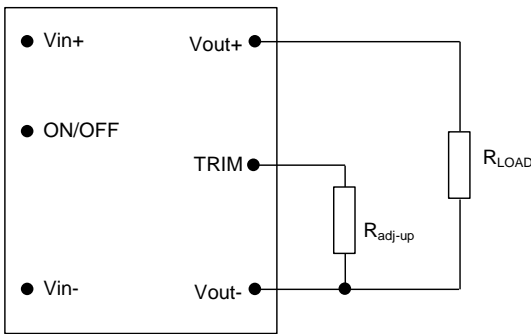

Figure 48. Circuit Configuration to Increase Output Voltage.

Table 1. Trim Constants SW series

Module	G	H	K	L
Sx001A0C	10,000	5110	12.5	2.5
Sx001A2B	10,000	5110	9.5	2.5
Sx003A0A	5110	2050	2.5	2.5
Sx003A5F	5110	2050	0.8	2.5

The combination of the output voltage adjustment and the output voltage initial tolerance must not exceed the allowable trim range of 90% to 110% of the nominal output voltage as measured between the Vout+ and Vout- pins.

The SW/SC power modules have a fixed current-limit set point. Therefore, as the output voltage is adjusted down, the available output power is reduced.

Trim Examples

For SW003A0A, nominal 5.0V module. To trim module down to 4.90V:

$$R_{adj-down} = \left[\frac{(4.9 - 2.5) \times 5110}{(5.0 - 4.9)} - 2050 \right] \Omega$$

$$R_{adj-down} = 120,590 \Omega$$

Thermal Considerations

The power modules operate in a variety of thermal environments; however, sufficient cooling should be provided to help ensure reliable operation.

Considerations include ambient temperature, airflow, module power dissipation, and the need for increased reliability. A reduction in the operating temperature of the module will result in an increase in reliability. The thermal data presented here is based on physical measurements taken in a wind tunnel.

The thermal reference point, T_{ref} used in the specifications is shown in Figure 49. For reliable operation this temperature should not exceed 120°C.

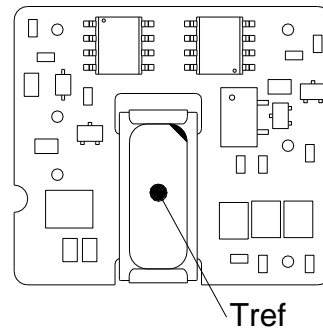

Figure 49. T_{ref} Temperature Measurement Location.

Heat Transfer via Convection

Increased airflow over the module enhances the heat transfer via convection. Derating figures showing the maximum output current that can be delivered by each module versus local ambient temperature (T_A) for natural convection and up to 3m/s (600 ft./min) are shown in the respective Characteristics Curves section.

Please refer to the Application Note “Thermal Characterization Process For Open-Frame Board-Mounted Power Modules” for a detailed discussion of thermal aspects including maximum device temperatures.

EMC Considerations

Figure 50 shows a suggested configuration to meet the conducted emission limits of EN55032 Class B.

Notes: C1, C2, C3 and C6 are low impedance SMT ceramics. C4 is a low impedance polymer film type (Paktron CS4). Common Mode inductor is Pulse Engineering type P0354 1.17mH.

SW/SC001/003 Series DC-DC Power Module

18-36Vdc & 36-75Vdc Input; 3.3-15Vdc Output; 1-3.5A Output Current

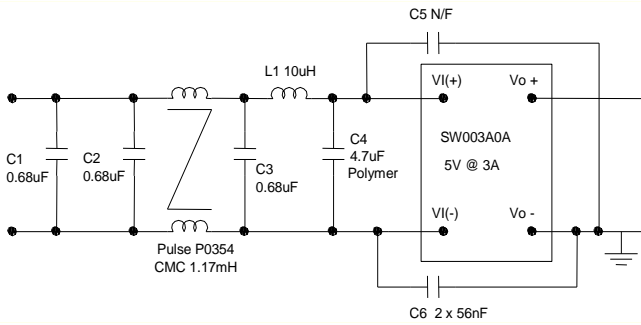

Figure 50. Suggested Configuration for EN55032 Class B.

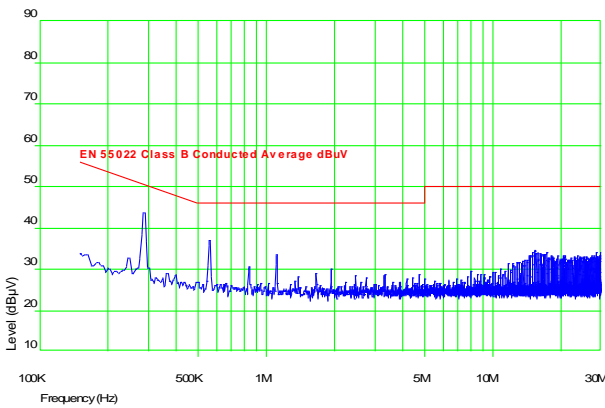

Figure 51. EMC signature using above filter, SW003A0A.

For further information on designing for EMC compliance, please refer to the FLTR100V10 data sheet (FDS01-043EPS).

Layout Considerations

The SW/SC power module series are low profile in order to be used in fine pitch system card architectures. As such, component clearance between the bottom of the power module and the mounting board is limited. Avoid placing copper areas on the outer layer directly underneath the power module. Also avoid placing via interconnects underneath the power module.

For additional layout guide-lines, refer to the FLTR100V10 data sheet.

The SW/SC family of power modules is available for either Through-Hole (TH) or Surface Mount (SMT) soldering.

Through-Hole Soldering Information

The RoHS-compliant (Z codes) through-hole products use the SAC (Sn/Ag/Cu) Pb-free solder and RoHS-compliant components. They are designed to be processed through single or dual wave soldering machines. The pins have an RoHS-compliant finish that is compatible with both Pb and Pb-free wave soldering processes. A maximum preheat rate of 3°C/s is suggested. The wave preheat process should be such that the temperature of the

power module board is kept below 210°C. For Pb solder, the recommended pot temperature is 260°C, while the Pb-free solder pot is 270°C max. Not all RoHS-compliant through-hole products can be processed with paste-through-hole Pb or Pb-free reflow process. If additional information is needed, please consult with your GEPower representative for more details.

Surface Mount Information

Pick and Place

The SW/SC-SR series of DC-to-DC power converters use an open-frame construction and are designed for surface mount assembly within a fully automated manufacturing process.

The SW/SC-SR series modules are designed to use the main magnetic component surface to allow for pick and place.

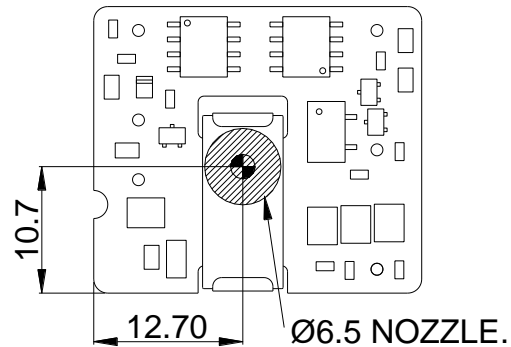

Note: All dimensions in mm.

Figure 52. Pick and Place Location.

Z Plane Height

The 'Z' plane height of the pick and place location is 7.50mm nominal with an RSS tolerance of +/-0.25 mm.

Nozzle Recommendations

The module weight has been kept to a minimum by using open frame construction. Even so, they have a relatively large mass when compared with conventional SMT components. Variables such as nozzle size, tip style, vacuum pressure and placement speed should be considered to optimize this process.

The minimum recommended nozzle diameter for reliable operation is 5mm. The maximum nozzle outer diameter, which will safely fit within the allowable component spacing, is 6.5mm. Oblong or oval nozzles up to 11 x 6 mm may also be used within the space available.

For further information please contact your local GE Sales Representative.

SW/SC001/003 Series DC-DC Power Module

18-36Vdc & 36-75Vdc Input; 3.3-15Vdc Output; 1-3.5A Output Current

Reflow Soldering Information

These power modules are large mass, low thermal resistance devices and typically heat up slower than other SMT components. It is recommended that the customer review data sheets in order to customize the solder reflow profile for each application board assembly.

The following instructions must be observed when SMT soldering these units. Failure to observe these instructions may result in the failure of or cause damage to the modules, and can adversely affect long-term reliability.

Surface Mount Information (continued)

The surface mountable modules in the SW/SC family use our SMT technology called "Column Pin" (CP) connectors. Figure 53 shows the CP connector before and after reflow soldering onto the end-board assembly.

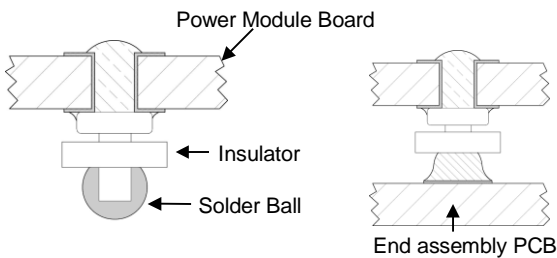

Figure 53. Column Pin Connector Before and After Reflow Soldering.

The CP is constructed from a solid copper pin with an integral solder ball attached, which is composed of tin/lead (Sn₆₃/Pb₃₇) solder for non-Z codes, or Sn/Ag_{3.8}/Cu_{0.7} (SAC) solder for -Z codes. The CP connector design is able to compensate for large amounts of co-planarity and still ensure a reliable SMT solder joint. Typically, the eutectic solder melts at 183°C (Sn/Pb solder) or 217-218°C (SAC solder), wets the land, and subsequently wicks the device connection. Sufficient time must be allowed to fuse the plating on the connection to ensure a reliable solder joint.

There are several types of SMT reflow technologies currently used in the industry. These surface mount power modules can be reliably soldered using natural forced convection, IR (radiant infrared), or a combination of convection/IR. The recommended linear reflow profile using Sn/Pb solder is shown in Figure 54 and 55. For reliable soldering the solder reflow profile should be established by accurately measuring the modules CP connector temperatures.

Lead Free Soldering

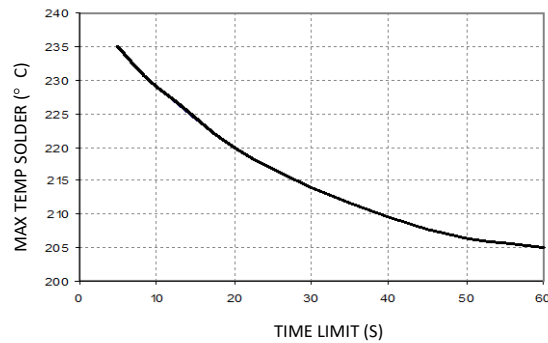

Figure 54. Recommended Reflow Profile for Sn/Pb solder.

The -Z version SMT modules of the SW/SC series are lead-free (Pb-free) and RoHS compliant and are compatible in a Pb-free soldering process. Failure to observe the instructions below may result in the failure of or cause damage to the modules and can adversely affect long-term reliability

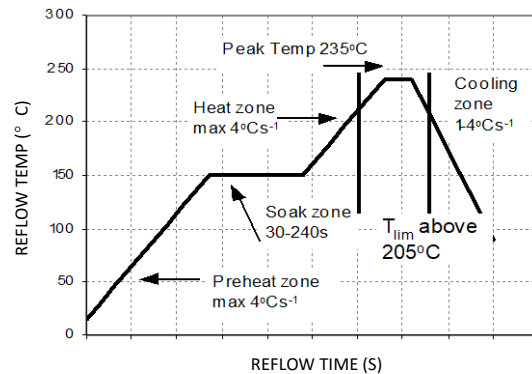

Figure 55. Time Limit, T_{lim}, Curve Above 205°C Reflow .

Pb-free Reflow Profile

Power Systems will comply with J-STD-020 Rev. D (Moisture/Reflow Sensitivity Classification for Nonhermetic Solid State Surface Mount Devices) for both Pb-free solder profiles and MSL classification procedures. This standard provides a recommended forced-air-convection reflow profile based on the volume and thickness of the package (table 4-2). The suggested Pb-free solder paste is Sn/Ag/Cu (SAC). The recommended linear reflow profile using Sn/Ag/Cu solder is shown in Figure. 56.

SW/SC001/003 Series DC-DC Power Module

18-36Vdc & 36-75Vdc Input; 3.3-15Vdc Output; 1-3.5A Output Current

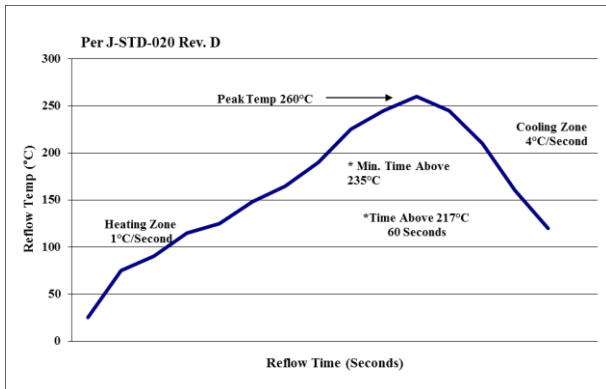

Figure 56. Recommended linear reflow profile using Sn/Ag/Cu solder.

MSL Rating

The SW/SC series SMT modules have a MSL rating of 2A.

Storage and Handling

The recommended storage environment and handling procedures for moisture-sensitive surface mount packages is detailed in J-STD-033 Rev. A (Handling, Packing, Shipping and Use of Moisture/Reflow Sensitive Surface Mount Devices). Moisture barrier bags (MBB) with desiccant are required for MSL ratings of 2 or greater. These sealed packages should not be broken until time of use. Once the original package is broken, the floor life of the product at conditions of $\leq 30^{\circ}\text{C}$ and 60% relative humidity varies according to the MSL rating (see J-STD-033A). The shelf life for dry packed SMT packages will be a minimum of 12 months from the bag seal date, when stored at the following conditions: $< 40^{\circ}\text{C}$, $< 90\%$ relative humidity.

Post Solder Cleaning and Drying Considerations

Post solder cleaning is usually the final circuit-board assembly process prior to electrical board testing. The result of inadequate cleaning and drying can affect both the reliability of a power module and the testability of the finished circuit-board assembly. For guidance on appropriate soldering, cleaning and drying procedures, refer to Lineage Power Board Mounted Power Modules: Soldering and Cleaning Application Note (AN04-001).

SW/SC001/003 Series DC-DC Power Module

18-36Vdc & 36-75Vdc Input; 3.3-15Vdc Output; 1-3.5A Output Current

Mechanical Outline for SW/SC Surface-Mount Module

Dimensions are in millimeters and (inches).

Tolerances: x.x mm ± 0.5 mm (x.xx in. ± 0.02 in.) [Unless otherwise indicated]

x.xx mm ± 0.25 mm (x.xxx in ± 0.010 in.)

Top View

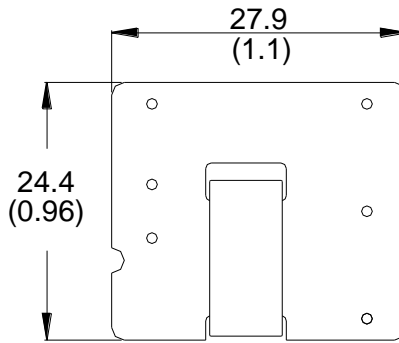

Side View

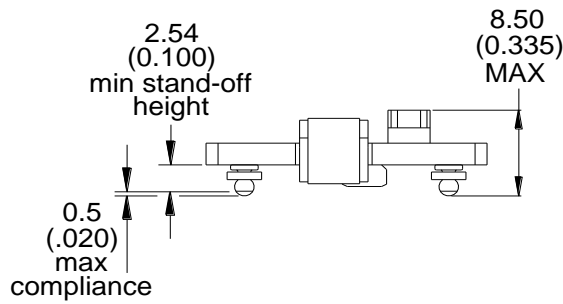

Bottom View

Pin	Function
1	Vin +
2	Vin -
3	ON/OFF
4	Vout +
5	TRIM
6	Vout -

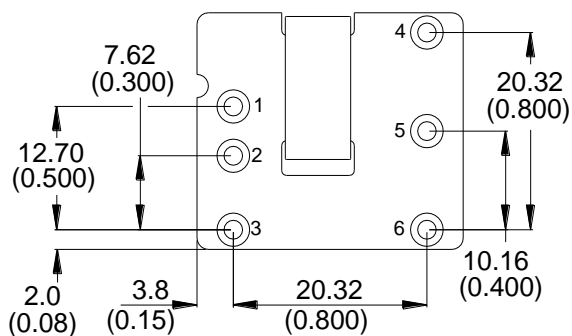

SW/SC001/003 Series DC-DC Power Module

18-36Vdc & 36-75Vdc Input; 3.3-15Vdc Output; 1-3.5A Output Current

Mechanical Outline for SW/SC Through Hole Module

Dimensions are in millimeters and (inches).

Tolerances: x.x mm ± 0.5 mm (x.xx in. ± 0.02 in.) [Unless otherwise indicated]

x.xx mm ± 0.25 mm (x.xxx in ± 0.010 in.)

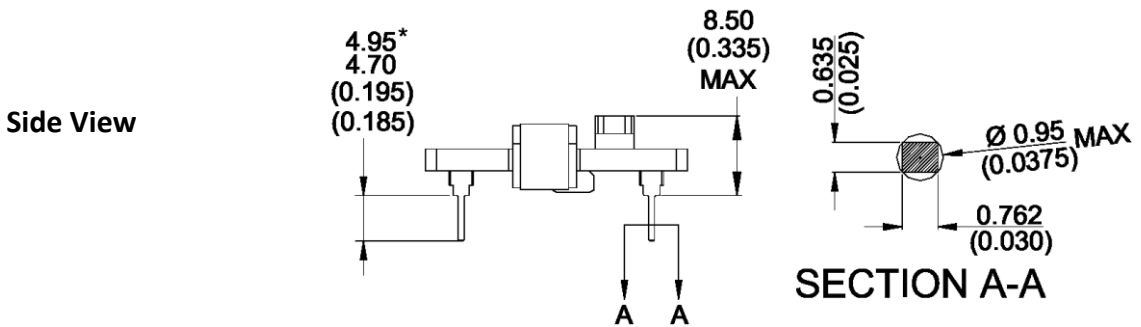
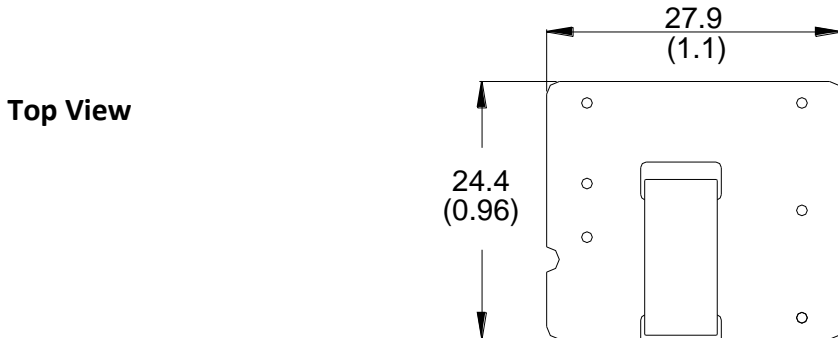

*For optional pin lengths, see Table 3, Device Options

Bottom View

Pin	Function
1	Vin +
2	Vin -
3	ON/OFF (Optional)
4	Vout +
5	TRIM (Optional)
6	Vout -

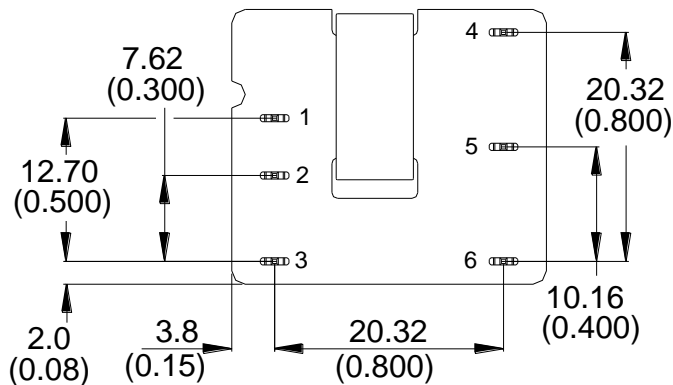

SW/SC001/003 Series DC-DC Power Module

18-36Vdc & 36-75Vdc Input; 3.3-15Vdc Output; 1-3.5A Output Current

Mechanical Outline for SW/SC -35 Option Through Hole Module

Dimensions are in millimeters and (inches).

Tolerances: x.xx mm ± 0.5 mm (x.xx in. ± 0.02 in.) [Unless otherwise indicated]

x.xx mm ± 0.25 mm (x.xxx in ± 0.010 in.)

Top View

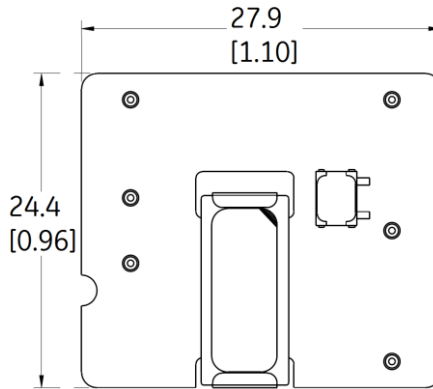

Side View

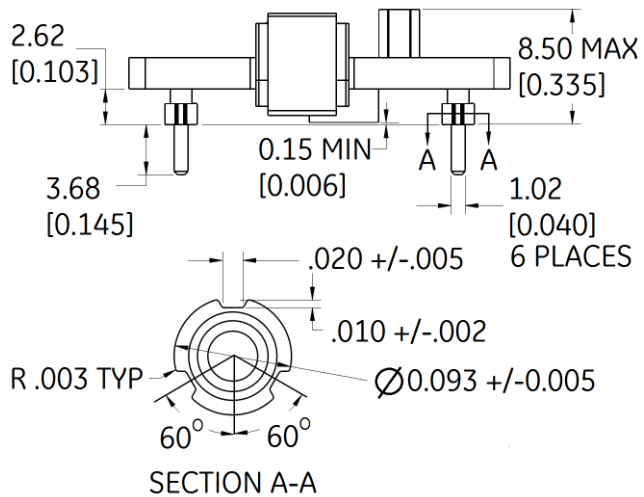

Bottom View

Pin	Function
1	Vin +
2	Vin -
3	ON/OFF (Optional)
4	Vout +
5	TRIM (Optional)
6	Vout -

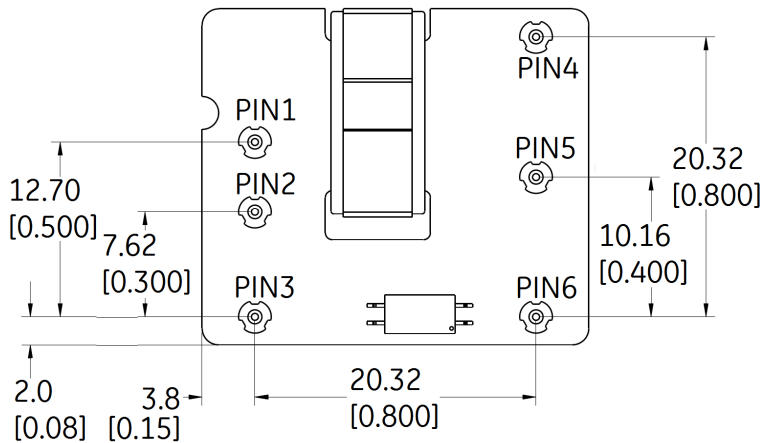

SW/SC001/003 Series DC-DC Power Module

18-36Vdc & 36-75Vdc Input; 3.3-15Vdc Output; 1-3.5A Output Current

SW/SC001/003 Series DC-DC Power Module

18-36Vdc & 36-75Vdc Input; 3.3-15Vdc Output; 1-3.5A Output Current

Recommended Pad Layout for Surface Mount and Through Hole Module

Dimensions are in millimeters and (inches).

Tolerances: x.x mm ± 0.5 mm (x.xx in. ± 0.02 in.) [Unless otherwise indicated]

x.xx mm ± 0.25 mm (x.xxx in ± 0.010 in.)

Pin	Function
1	Vin +
2	Vin -
3	ON/OFF
4	Vout +
5	TRIM
6	Vout -

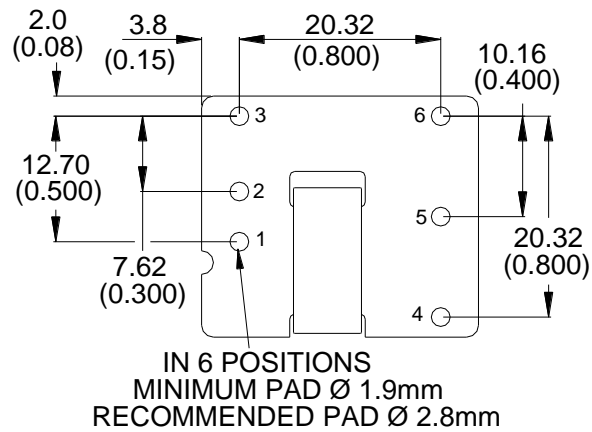

Surface Mount Pad Layout – Component side view

Pin	Function
1	Vin +
2	Vin -
3	ON/OFF (Optional)
4	Vout +
5	TRIM (Optional)
6	Vout -

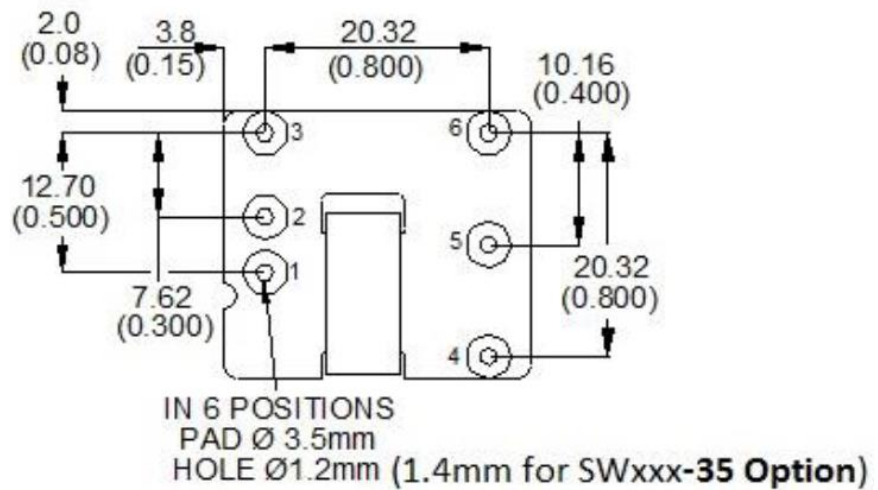

Through-Hole Pad Layout – Component side view

SW/SC001/003 Series DC-DC Power Module

18-36Vdc & 36-75Vdc Input; 3.3-15Vdc Output; 1-3.5A Output Current

Packaging Details

The SW001/003 series SMT versions are supplied in tape & reel as standard. Details of tape dimensions are shown below. Modules are shipped in quantities of 150 modules per reel.

Tape Dimensions

Dimensions are in millimeters and (inches).

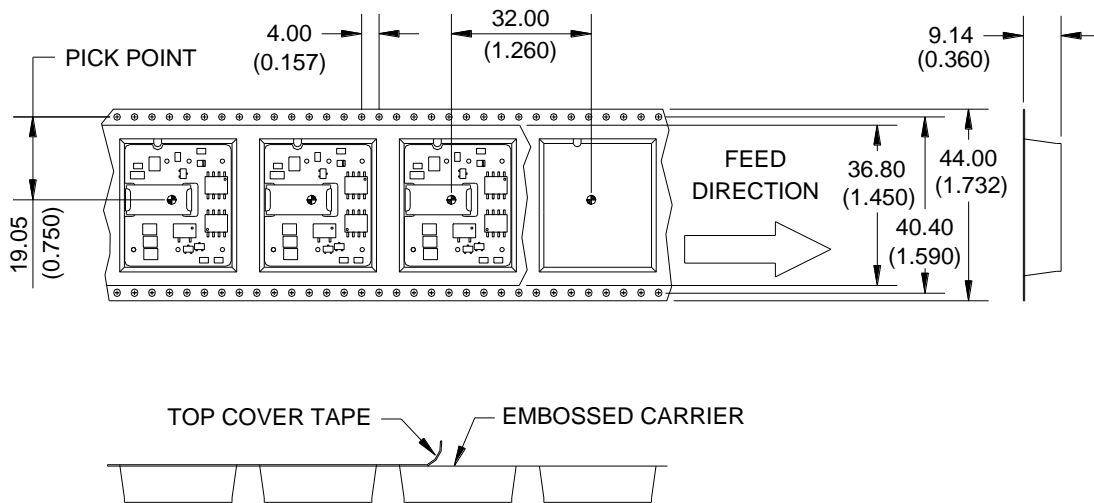

NOTE: CONFORMS TO EAI-481 REV. A STANDARD

Reel Dimensions

Outside Diameter: 330.2 mm (13.00")

Inside Diameter: 177.8 mm (7.00")

Tape Width: 44.00 (1.732)

SW/SC001/003 Series DC-DC Power Module

18-36Vdc & 36-75Vdc Input; 3.3-15Vdc Output; 1-3.5A Output Current

SW/SC001/003 Series DC-DC Power Module

18-36Vdc & 36-75Vdc Input; 3.3-15Vdc Output; 1-3.5A Output Current

Ordering Information

Please contact your GE Sales Representative for pricing, availability and optional features.

Table 2. Device Codes

Product codes	Input Voltage	Output Voltage	Output Current	Remote On/Off Logic	Connector Type	Comcodes
SW001A0C91Z	48 Vdc	15.0V	1.0A	Negative	Through-Hole	CC109107331
SW001A2B91-33Z	48 Vdc	12.0V	1.2A	Negative	Through-Hole	CC109104568
SW001A2B9Z	48 Vdc	12.0V	1.2A	Not present	Through-Hole	CC109107348
SW001A2B91Z	48 Vdc	12.0V	1.2A	Negative	Through-Hole	CC109107356
SW001A2B961-33BZ	48 Vdc	12.0V	1.2A	Negative	Through-Hole	CC109120623
SW001A2B91-SRZ	48 Vdc	12.0V	1.2A	Negative	SMT (tape & reel)	108995718
SW003A0A91Z	48 Vdc	5.0V	3.0A	Negative	Through-Hole	CC109107380
SW003A0A94Z	48 Vdc	5.0V	3.0A	Positive	Through-Hole	CC109107397
SW003A0A9Z	48 Vdc	5.0V	3.0A	Not present	Through-Hole	CC109107372
SW003A0AZ	48 Vdc	5.0V	3.0A	Not present	Through-Hole	CC109107364
SW003A0A91-SRZ	48 Vdc	5.0V	3.0A	Negative	SMT (tape & reel)	109100468
SW003A0A94-SRZ	48 Vdc	5.0V	3.0A	Positive	SMT (tape & reel)	109100476
SW003A5F91Z	48 Vdc	3.3V	3.5A	Negative	Through-Hole	CC109107406
SW003A5F94Z	48 Vdc	3.3V	3.5A	Positive	Through-Hole	CC109107414
SW003A5F961Z	48 Vdc	3.3V	3.5A	Negative	Through-Hole	CC109144457
SW003A5F961-35Z	48 Vdc	3.3V	3.5A	Negative	Through-Hole	150030970
SW003A5F91-SRZ	48 Vdc	3.3V	3.5A	Negative	SMT (tape & reel)	109100492
SW003A5F94-SRZ	48 Vdc	3.3V	3.5A	Positive	SMT (tape & reel)	CC109114526
SC001A2B91Z	24 Vdc	12.0V	1.2A	Negative	Through-Hole	CC109107298
SC001A2B91-SRZ	24 Vdc	12.0V	1.2A	Negative	SMT (tape & reel)	CC109121976
SC003A0A91Z	24 Vdc	5.0V	3.0A	Negative	Through-Hole	CC109107307
SC003A0A94Z	24 Vdc	5.0V	3.0A	Positive	Through-Hole	CC109107315
SC003A5F91Z	24 Vdc	3.3V	3.5A	Negative	Through-Hole	CC109107323
SC003A5F91-SRZ	24 Vdc	3.3V	3.5A	Negative	SMT (tape & reel)	109100435

SW/SC001/003 Series DC-DC Power Module

18-36Vdc & 36-75Vdc Input; 3.3-15Vdc Output; 1-3.5A Output Current

Table 3. Device Options

Option*	Device Code Suffix**
Negative remote on/off logic (On/Off pin fitted)†	1
Positive remote on/off logic (On/Off pin fitted) †	4
Mechanically Trimmed Short Pins, 3.68 mm ± 0.25mm (0.145 in. ± 0.010 in.)	6
Output Voltage Adjustment (Trim pin fitted) †	9
Uncut Short Pins, 3.68 mm ± 0.25mm (0.145 in. ± 0.020 in.)	-35
Surface mount connections, SMT (Tape & Reel)	-SR
RoHS Compliant	-Z

* Please contact GE Sales Representative for availability of these options, samples, minimum order quantity and lead times. Legacy device codes may contain a –B option suffix to indicate 100% factory Hi-Pot tested to the isolation voltage specified in the Absolute Maximum Ratings table. The 100% Hi-Pot test is now applied to all device codes, with or without the –B option suffix. Existing comcodes for devices with the –B suffix are still valid; however, no new comcodes for devices containing the –B suffix will be created.

** When adding multiple options to the product code, add numerical suffix codes in the descending order.

† Either negative or positive logic (1 or 4), and output voltage adjustment (trim, 9) must be ordered on surface mount , SMT (-SR) device codes. Both the on/off pin and trim pin will be provided on all –SR device codes.



Contact Us

For more information, call us at

USA/Canada:

+1 888 546 3243, or +1 972 244 9288

Asia-Pacific:

+86-21-53899666

Europe, Middle-East and Africa:

+49.89.878067-280

[Go.ABB/Industrial](#)

GE Critical Power reserves the right to make changes to the product(s) or information contained herein without notice, and no liability is assumed as a result of their use or application. No rights under any patent accompany the sale of any such product(s) or information.

Mouser Electronics

Authorized Distributor

Click to View Pricing, Inventory, Delivery & Lifecycle Information:

[ABB:](#)

[SC003A0A91Z](#) [SC003A5F91Z](#) [SW001A2B91Z](#) [SW003A0A91-SRZ](#) [SW003A0A91Z](#) [SW003A5F91-SRZ](#)
[SW003A5F91Z](#) [SC001A2B91Z](#) [SC003A0A91-SRZ](#) [SW001A2B961-BZ](#) [SW003A0A91-SMWZ](#) [SW003A0A91-SRBZ](#)
[SW003A5F91-SRBZ](#) [SW003A5F961Z](#) [SC001A2B91-SRZ](#) [SC003A5F91-SRZ](#) [SW001A0C91Z](#) [SW001A2B91-SRZ](#)
[SW003A0AZ](#) [SW003A0A9Z](#) [SW003A0A94Z](#) [SW003A0A94-SRZ](#) [SW003A5F94Z](#) [SW003A5F94-SRZ](#)